

2012 Building Code Compendium

Volume 2

January 1, 2022 update
(Containing O. Reg. 867/21)

COMMENCEMENT

Supplementary Standards SA-1, SB-1 to SB-13 and SC-1 come into force on the 1st day of January, 2014.

See “Code Amendment History” page in the Preface of Volume 1 for information concerning amendments to Supplementary Standards issued through Minister’s Rulings.

- a1 Amendment made to Appendix A or B issued for January 1st, 2014.
- a2 Amendment made to Appendix A or B issued for January 1st, 2014.
- a2.1 Amendment made to Appendix A or B issued for January 1st, 2015.
- a3 Amendment made to Appendix A or B issued for January 1st, 2015.
- a4 Amendment made to Appendix A or B issued for July 7th, 2016.
- a5 Amendment made to Appendix A or B issued for July 1st, 2017.
- a5.1 Amendment made to Appendix A or B issued for January 1st, 2018.
- a6 Amendment made to Appendix A or B issued for January 18th, 2018.
- a7 Amendment made to Appendix A or B issued for May 4th, 2018.
- a8 Amendment made to Appendix A or B issued for June 29th, 2018.
- a9 Amendment made to Appendix A or B issued for July 20th, 2018.
- a10 Amendment made to Appendix A or B issued for May 2nd, 2019.
- a10.1 Amendment made to Appendix A or B issued for January 1st, 2020.
- a10.2 Amendment made to Appendix A or B issued for January 1st, 2022.
- a11 Amendment made to Appendix A or B issued for December 16th, 2020.
- a12 Amendment made to Appendix A or B issued for January 1st, 2022.

EDITORIAL

- e1 Editorial correction issued for January 1st, 2014.
- e2 Editorial correction issued for January 1st, 2014.
- e2.1 Editorial correction issued for January 1st, 2015.
- e3 Editorial correction issued for January 1st, 2015.
- e4 Editorial correction issued for July 7th, 2016.
- e5 Editorial correction issued for January 1st, 2017.
- e6 Editorial correction issued for January 1st, 2018.
- e7 Editorial correction issued for January 1st, 2020.
- e7.1 Editorial correction issued for January 1st, 2022.
- e8 Editorial correction issued for December 16th, 2020.
- e9 Editorial correction issued for January 1st, 2022.

COVER PHOTO CREDITS

1	2	3	4
5	6	7	8

1. Stephen Hawking Centre at the Perimeter Institute of Theoretical Physics; Teeple Architects Inc.; Scott Norsworthy Photography
2. Lawren Harris House; Drew Mandel Architects; Tom Arban Photography Inc.
3. Sisters of St. Joseph Motherhouse; Teeple Architects Inc.; Shai Gil Photography
4. James Bartleman Archives and Library Materials Centre; Shoalts & Zaback Architects Ltd. / Barry J. Hobin & Associates Architects Inc.; Tom Arban Photography Inc.
5. Ottawa Convention Centre; bbb architects; William P. McElligott Photography
6. Renfrew County Courthouse; NORR Limited Architects Engineers & Planners; Steven Evans Photography
7. Stephen Hawking Centre at the Perimeter Institute of Theoretical Physics; Teeple Architects Inc.; Shai Gil Photography
8. James Bartleman Archives and Library Materials Centre; Shoalts & Zaback Architects Ltd. / Barry J. Hobin & Associates Architects Inc.; Tom Arban Photography Inc.

© Copyright Queen's Printer for Ontario, 2022

ISBN 978-1-4868-5895-8 Digital – Set
ISBN 978-1-4868-5897-2 Digital – Vol. 2

All rights reserved.

Questions regarding copyright, including reproduction and distribution, may be directed to the Director, Building and Development Branch, of the Ministry of Municipal Affairs and Housing.

Tel: 416-585-6666
 E-Mail: Codeinfo@mah.gov.on.ca

Table of Contents

Volume 1

Preface

Highlights of Major Changes in 2012 Code

Code Amendment History

Building Code Act

Building Code

Division A Compliance, Objectives and Functional Statements

Part 1 Compliance and General

Part 2 Objectives

Part 3 Functional Statements

Division B Acceptable Solutions

Part 1 General

Part 2 Reserved

Part 3 Fire Protection, Occupant Safety and Accessibility

Part 4 Structural Design

Part 5 Environmental Separation

Part 6 Heating, Ventilating and Air-Conditioning

Part 7 Plumbing

Part 8 Sewage Systems

Part 9 Housing and Small Buildings

Part 10 Change of Use

Part 11 Renovation

Part 12 Resource Conservation

Division C Administrative Provisions

Part 1 General

Part 2 Alternative Solutions, Disputes, Rulings and Interpretations

Part 3 Qualifications

Part 4 Transition, Revocation and Commencement

Index

Pending Amendments

Volume 2

Appendix A Explanatory Information

Appendix B Imperial Conversion

Supplementary Standards

SA-1 Attribution Tables

SB-1 Climatic and Seismic Data

SB-2 Fire Performance Ratings

SB-3 Fire and Sound Resistance of Building Assemblies

SB-4 Measures for Fire Safety in High Buildings

SB-5 Reserved

SB-6 Percolation Time and Soil Descriptions

SB-7 Construction Requirements for Guards

SB-8 Design, Construction and Installation of Anchorage Systems
for Fixed Access Ladders

SB-9 Requirements for Soil Gas Control

SB-10 Energy Efficiency Supplement

SB-11 Construction of Farm Buildings

SB-12 Energy Efficiency of Housing

SB-13 Glass in Guards

SC-1 Code of Conduct for Registered Code Agencies

Forms

Appendix A

Appendix A to this document is included for explanatory purposes only and does not form part of the requirements. The bold-face reference numbers that introduce each item apply to the requirements in the Code.

Explanatory Material for Division A

A-1.1.2. Limit of Application.

The provisions in this Code are intended to establish minimum acceptable standards for public health and public safety, fire protection, structural sufficiency, conservation, environmental integrity, barrier-free use and access. They are not intended to be applied to voluntary installations unless specified in the Code.

For example, a firewall installed for insurance purposes need not comply with the requirements in Subsection 3.1.8. of Division B unless it is used as a means to create 2 buildings for the purposes of other Code requirements. Similarly, it is not intended that voluntary standpipe installations comply with the relevant requirements in Subsection 3.2.9. of Division B. Voluntary installations should not detrimentally affect features required by the Code.

A-1.1.2.7. Existing Buildings.

This Article describes the extent of renovation subject to the Building Code: only the areas or portions of a building being renovated, or other parts of a building adversely affected by that renovation need comply with the requirements of the Code; all other areas or portions need not comply with the Code and may remain unchanged.

A-1.1.3.1. Buildings Divided by Firewalls.

This concept relates to the provisions directly regulated by this Code and does not apply to electrical service entrance and natural gas service requirements which are regulated by other documents.

A-1.2.1.1.(1)(a) Compliance Via Acceptable Solutions.

If a building design (e.g. material, component, assembly or system) can be shown to meet all provisions of the applicable acceptable solutions in Division B (e.g. it complies with the applicable provisions of a referenced standard), it is deemed to have satisfied the objectives and functional statements linked to those provisions and thus to have complied with that part of the Code. In fact, if it can be determined that a design meets all the applicable acceptable solutions in Division B, there is no need to consult the objectives and functional statements in Division A to determine its compliance.

A-1.2.1.1.(1)(b) Compliance Via Alternative Solutions.

Where a design differs from the acceptable solutions in Division B, then it should be treated as an “alternative solution”. A proponent of an alternative solution must demonstrate that the alternative solution addresses the same issues as the applicable acceptable solutions in Division B and their attributed objectives and functional statements. However, because the objectives and functional statements are entirely qualitative, demonstrating compliance with them in isolation is not possible. Therefore, Clause 1.2.1.1.(1)(b) identifies the principle that Division B establishes the quantitative performance targets that alternative solutions must meet. In many cases, these targets are not defined very precisely by the acceptable solutions - certainly far less precisely than would be the case with a true performance code, which would have quantitative performance targets and prescribed methods of performance measurement for all aspects of building performance. Nevertheless, Clause 1.2.1.1.(1)(b) makes it clear that an effort must be made to demonstrate that an alternative solution will perform as well as a design that would satisfy the applicable acceptable solutions in Division B - not “well enough” but “as well as”. In this sense, it is Division B that defines the boundaries between acceptable risks and the “unacceptable” risks referred to in the statements of the Code’s objectives, i.e. the risk remaining once the applicable acceptable solutions in Division B have been implemented represents the residual level of risk deemed to be acceptable by the broad base of Canadians who have taken part in the consensus process used to develop the Code.

Level of Performance

Where Division B offers a choice between several possible designs, it is likely that these designs may not all provide exactly the same level of performance. Among a number of possible designs satisfying acceptable solutions in Division B, the design providing the lowest level of performance should generally be considered to establish the minimum acceptable level of performance to be used in evaluating alternative solutions for compliance with the Code.

Sometimes a single design will be used as an alternative solution to several sets of acceptable solutions in Division B. In this case, the level of performance required of the alternative solution should be at least equivalent to the overall level of performance established by all the applicable sets of acceptable solutions taken as a whole.

Each provision in Division B has been analyzed to determine to what it applies and what it is intended to achieve. The resultant application and intent statements clarify what undesirable results each provision seeks to preclude. These statements are not a legal component of the Code, but are advisory in nature, and can help Code users establish performance targets for alternative solutions.

Areas of Performance

A subset of the acceptable solutions in Division B may establish criteria for particular types of designs (e.g. certain types of materials, components, assemblies, or systems). Often such subsets of acceptable solutions are all attributed to the same objective: Fire Safety, for example. In some cases, the designs that are normally used to satisfy this subset of acceptable solutions might also provide some benefits that could be related to some other objective: Fire Protection of the Building, for example. However, if none of the applicable acceptable solutions are linked to Objective OP1, Fire Protection of the Building, then alternative solutions proposed to replace these acceptable solutions are not required to provide a similar benefit related to Fire Protection of the Building. In other words, the acceptable solutions in Division B establish acceptable levels of performance for compliance with Division B only in those areas defined by the objectives and functional statements attributed to the acceptable solutions.

Applicable Acceptable Solutions

In demonstrating that an alternative solution will perform as well as a design that would satisfy the applicable acceptable solutions in Division B, its evaluation should not be limited to comparison with the acceptable solutions to which an alternative is proposed. It is possible that acceptable solutions elsewhere in the Code also apply. The proposed alternative solution may be shown to perform as well as the most apparent acceptable solution which it is replacing but may not perform as well as other relevant acceptable solutions. For example, an innovative sheathing material may perform adequately as sheathing in a wall system that is braced by other means but may not perform adequately as sheathing in a wall system where the sheathing must provide the structural bracing. All applicable acceptable solutions should be taken into consideration in demonstrating the compliance of an alternative solution.

Relationship Between Division A and Division B

Supplementary Standard SA-1 sets out the objectives and functional statements which have been attributed to the acceptable solutions provided in Division B of the Building Code.

“Acceptable solution” is defined in Article 1.4.1.2. of Division A. Objectives and functional statements have accordingly been attributed to each provision of Parts 3 to 12 of Division B that is considered to be a “requirement”; that is, a provision that provides criteria necessary to determine compliance with Division B. Requirements may specify performance values, qualities, quantities, design methods and test methods that are required in order to comply with Division B.

Objectives and functional statements have not been attributed to provisions of Division B which are not considered to be “requirements”, but rather assist in the interpretation of requirements by fulfilling the following functions:

- Introductions: specifies the scope and/or application of requirements (for example, Sentence 5.1.2.1.(1) of Division B, which specifies that application of Part 5);

- Application modifiers: expand or limit the application of a requirement without changing its intent (for example, Sentence 9.35.2.1.(1) of Division B, which expands the application of the requirements for garages to a carport with more than 60% of its perimeter enclosed);
- Exemptions: waive the application of a requirement (for example, Sentence 6.2.2.3.(6) of Division B, which exempts open-air storeys in a storage garage from the mechanical exhaust requirements of the remainder of Article 6.2.2.3.);
- Signpost: provides direction to another requirement which would in any event be applicable (for example, Sentence 3.13.5.1. of Division B, which directs the Code user to the requirements of Subsection 3.2.4. for fire alarm and detection systems in rapid transit stations);
- Classifications: categorize and sort requirements or aspects of requirements (for example, Sentence 8.1.2.1.(1) of Division B, which classifies the types of sewage systems)
- Clarifications: explain the intent of a requirement (for example, Sentence 5.2.2.1.(2) of Division B, which identifies the structural loads referenced in the remainder of Article 5.2.2.1.);
- Definitions: defining terms used in a requirement (for example, Sentence 7.1.3.1.(1) of Division B, which defines “storey” for the purpose of Part 7);
- Administrative provisions: specifies the use of, and determination of compliance with, requirements (for example, Sentence 9.7.4.3.(4) of Division B, which requires labelling of exterior wood doors to facilitate enforcement of the requirements of the remainder of Article 9.7.4.3.);

Requirements of Division B will often be dependent on other provisions of Division B to which objectives and functional statements have not been attributed.

For example, Sentence 3.2.4.1.(2) of Division B lists the conditions when a fire alarm system is required. Objective OS1.5 and functional statement F11 are attributed to this requirement. However, this sentence must also be examined in the context of Sentences 3.2.4.1.(3), (4) and (5), which are not characterized as requirements (and therefore have not been attributed objectives or functional statements) but are necessary to explain the context of that Sentence. In this instance, Sentences (3), (4) and (5) list exceptions and modifications to Sentence (2).

As a result, in evaluating the level of performance of an acceptable solution for the purposes of assessing an alternative solution, regard must be had both to requirements (to which objectives and functional statements have been attributed in this Standard) and to other provisions (to which objectives and functional statements have not been attributed in this Standard) related to the requirement.

A-1.4.1.2.(1) Defined Terms.

a2.1 Adaptable Seating

Adaptable seating enables persons in wheelchairs to transfer to a fixed seat without the obstruction of an armrest.

Exit

Exits include doors or doorways leading directly into an exit stair or directly to the outside. In the case of an exit leading to a separate building, exits also include vestibules, walkways, bridges and balconies.

Farm Building

Farm buildings as defined in Article 1.4.1.2. include but are not limited to produce storage and packing facilities, livestock and poultry housing, milking centres, manure storage facilities, grain bins, silos, feed preparation centres, farm workshops, greenhouses, farm retail centres, and horse riding, exercise and training facilities. Farm buildings may be classed as low or high human occupancy depending on the occupant load.

Examples of farm buildings likely to be classed as low human occupancy as defined in Article 1.2.1.2. of the National Farm Building Code of Canada are livestock and poultry housing, manure and machinery storage facilities and horse exercise and training facilities where no bleachers or viewing area are provided.

Examples of other buildings that would be classed as other than low human occupancy include farm retail centres for feeds, horticultural and livestock produce, auction barns and show areas where bleachers or other public facilities are provided. Farm work centres where the numbers of workers frequently exceeds the limit for low human occupancy will also be in this category.

It is possible to have areas of both high and low human occupancy in the same building provided that the structural safety and fire separation requirements for high human occupancy are met in the part thus designated.

Fire Separation

A fire separation may or may not have a fire-resistance rating.

Heritage Building

This definition facilitates acknowledgement and acceptance of the significance of such a building through creditable means.

Plumbing System

“Plumbing” is defined in the *Building Code Act, 1992*. Each of the three systems (drainage, venting, water) appearing in the definition are further defined in Article 1.4.1.2., with the end result that a plumbing system encompasses all three elements.

Other piping systems as listed below are excluded from plumbing system since the definition of water system limits the system to the point of juncture with outlets, fixtures, etc. Similarly, a drainage system starts at the fixture or plumbing appliance it drains.

A plumbing system does not include,

- e1 (a) a system of piping,
 - (i) for space heating in which water is used as a medium to transfer heat,
 - (ii) in which liquids or vapours are circulated for the purpose of cooling or refrigeration,
 - (iii) through which air is passed for the purpose of controlling the temperature, humidity or motion of air passing through the system,
 - (iv) that conveys water for the purpose of providing water or nutrients to the soil,
 - (v) that conveys water for the purpose of landscaping or for the care of animals, birds or fish,
 - (vi) that transmits force by means of water or by means of a liquid other than water in which water is used for cooling,
 - (vii) that conveys liquids for the purpose of melting ice or snow, or
 - (viii) that uses water in the conveyance of flammable gas or fuel; or
- (b) a well, a well pump installed for the purpose of conveying water from a well, a pressure tank and pump if the tank and pump are combined as a unit, the piping between any well pump and the well, the piping between a well pump and a pressure tank that is installed separate from the pump and the connection of the piping to such pressure tank, and when there is no well pump, any piping connected to the well for a distance of three feet from the outside of the well.

Public Corridor

A covered mall is considered to be a public corridor and, as such, is subject to the same requirements as a public corridor.

Public Heritage Building

This definition addresses smaller heritage buildings that are to be made available to the public for viewing as examples of an architectural period or periods in the past, depicting how our forebears lived, worked or played, and what artifacts, objects or clothing were in use at that time. These buildings are not considered museums as such, and therefore would not be subject to the more stringent requirements of assembly occupancies for that use.

Service Room

Typical examples of service rooms include boiler rooms, furnace rooms, incinerator rooms, garbage handling rooms, and rooms to accommodate air-conditioning or heating appliances, pumps, compressors and electrical equipment. Rooms such as elevator machine rooms and common laundry rooms are not considered as service rooms.

Suite

Tenancy in the context of the term “suite” applies to both rental and ownership tenure. In a condominium arrangement, for example, dwelling units are considered separate suites even though they are individually owned. In order to be of complementary use, a series of rooms that constitute a suite are in reasonably close proximity to each other and have access to each other either directly by means of a common doorway or indirectly by a corridor, vestibule or other similar arrangement.

The term “suite” does not apply to rooms such as service rooms, common laundry rooms and common recreational rooms that are not leased or under a separate tenure in the context of the Code. Similarly, the term suite is not normally applied in the context of buildings such as schools and hospitals, since the entire building is under a single tenure. A rented room in a long-term care home could be considered as a suite if the room was under a separate tenure. A hospital bedroom on the other hand is not considered to be under a separate tenure, since the patient has little control of that space, even though he pays the hospital a per diem rate for the privilege of using the hospital facilities, which include the sleeping areas.

For certain requirements in the Code, the expression “room or suite” is used (e.g. travel distance). This means that the requirement applies within the rooms of suites as well as to the suite itself and to rooms that may be located outside the suite. In other places the expression “suite, and rooms not located within a suite” is used (e.g. for the installation of smoke and heat detectors). This means that the requirement applies to individual suites as defined, but not to each room within the suite. The rooms “not within a suite” would include common laundry rooms, common recreational rooms and service rooms, that are not considered as tenant occupied space.

a12 A-1.4.1.3. Applicable Law.

Applicants for building permits are required to establish compliance with applicable law. The following table lists contact information for those agencies responsible for the statutory provisions defined in Sentence 1.4.1.3.(1):

Applicable Law Provision	Responsible Agency	Contact
<p><i>City of Toronto Act, 2006:</i> Subsection 102(3) of the <i>City of Toronto Act, 2006</i> By-laws made under section 108 of the <i>City of Toronto Act, 2006</i> but only with respect to the issuance of a permit for the construction of a green roof. Section 114 of the <i>City of Toronto Act, 2006</i>, with respect to the approval by the City of Toronto or the Ontario Land Tribunal of plans and drawings.</p>	<p>City of Toronto</p>	<p>General Inquiry: ph: 311 or 416-392-2489</p>

Applicable Law Provision	Responsible Agency	Contact
<p><i>Clean Water Act, 2006:</i> Clause 59(1)(b) of the <i>Clean Water Act, 2006</i> with respect to the issuance of a notice by the risk management official for the construction of a building.</p>	Ministry of the Environment, Conservation and Parks	General Inquiry: ph: 416-325-4000 or 800-565-4923
<p><i>Conservation Authorities Act:</i> Clause 28(1)(c) under the <i>Conservation Authorities Act</i>, with respect to the permission of the authority for the construction of a building if the control of flooding, erosion, dynamic beaches or pollution may be affected by the development.</p>	Local Conservation Authority	
<p><i>Child Care and Early Years Act, 2014:</i> Section 14 of Regulation 137/15, under the <i>Child Care and Early Years Act, 2014</i>, with respect to the approval of plans for a new building to be erected or an existing building to be used, altered or renovated for use as a child care centre or for alterations or renovations to be made to premises used by a child care centre.</p>	Ministry of Children, Community and Social Services	General Inquiry: ph: 416-212-7432 Central East Regional Office ph: 905-868-8900 Central West Regional Office ph: 905-567-7177 or 877-832-2818 Eastern Regional Office ph: 613-234-1188 or 800-267-5111 Hamilton/Niagara Regional Office ph: 905-521-7280 North East Regional Office ph: 705-474-3540 or 800-461-6977 Northern Regional Office ph: 705-564-6699 or 800-265-1222 South East Regional Office ph: 613-545-0539 or 800-646-3209 South West Regional Office ph: 519-438-5111 or 800-265-4197 Toronto Regional Office ph: 416-325-0500
<p><i>Development Charges Act, 1997:</i> Sections 28 and 53 under the <i>Development Charges Act, 1997</i>.</p>	Local Municipality	
<p><i>Education Act:</i> <i>Education Act</i>, Section 194, with respect to the approval of the Minister for the demolition of a building.</p>	Ministry of Education	General Inquiry ph: 416-325-2929 or 800-387-5514
<p><i>Education Act:</i> Sections 257.83 and 257.93 under the <i>Education Act</i>.</p>	Local Municipality	
<p><i>Elderly Persons Centres Act:</i> Section 6 of Regulation 314, of the <i>Elderly Persons Centres Act</i>, with respect to the approval of the Minister for the construction of a building project.</p>	Ministry of Health and Long-Term Care	General Inquiry: ph: 416-327-4327 or 800-268-1153

Applicable Law Provision	Responsible Agency	Contact
<p><i>Environmental Assessment Act:</i> Section 5 of the <i>Environmental Assessment Act</i>, with respect to the approval of the Ministry or the Ontario Land Tribunal to proceed with an undertaking. Subsection 5(4) of the <i>Environmental Assessment Act</i></p>	Ministry of the Environment, Conservation and Parks	General Inquiry: ph: 416-325-4000 or 800-565-4923 Environmental Approvals Branch ph: 416-314-8001 or 800-461-6290
<p><i>Environmental Protection Act:</i> Section 46 of the <i>Environmental Protection Act</i> with respect to the approval of the Minister to use land or land covered by water that has been used for the disposal of waste. Section 47.3 of the <i>Environmental Protection Act</i>, with respect to the issuance of a renewable energy approval. Section 168.3.1 of the <i>Environmental Protection Act</i>, with respect to the construction of a building to be used in connection with a change of use of a property. Paragraph 2 of Subsection 168.6(1) of the <i>Environmental Protection Act</i>, if a certificate of property use has been issued in respect of the property under subsection 168.6(1) of the Act.</p>	Ministry of the Environment, Conservation and Parks	General Inquiry: ph: 416-325-4000 or 800-565-4923 Central Region ph: 416-326-6700 or 800-810-8048 Eastern Region ph: 613-549-4000 or 800-267-0974 Northern Region ph: 807-475-1205 or 800-875-7772 Southwestern Region ph: 519-873-5000 or 800-265-7672 West Central Region ph: 905-521-7640 or 800-668-4557
<p><i>Milk Act</i> Section 14 of the <i>Milk Act</i>, with respect to the permit from the Director for the construction or alteration of any building intended for use as a plant.</p>	Ministry of Agriculture, Food and Rural Affairs	General Inquiry ph: 519-826-3100 or 888-466-2372
<p><i>Municipal Act, 2001</i> Subsection 133(4) of the <i>Municipal Act, 2001</i>.</p>	Local Municipality	
<p><i>Niagara Escarpment Planning and Development Act:</i> Subsection 24(3) of the <i>Niagara Escarpment Planning and Development Act</i>.</p>	Ministry of Natural Resources and Forestry	General Inquiry ph: 800-667-1940 Niagara Escarpment Commission ph: 905-877-5191
<p><i>Nutrient Management Act, 2002:</i> Section 11.1 of O. Reg. 267/03 of the <i>Nutrient Management Act, 2002</i>, with respect to a proposed building or structure to house farm animals or store nutrients if that Regulation requires the preparation and approval of a nutrient management strategy before construction of the proposed building or structure.</p>	Ministry of Agriculture, Food and Rural Affairs	General Inquiry ph: 519-826-3100 or 888-466-2372

Applicable Law Provision	Responsible Agency	Contact
<p><i>Ontario Heritage Act:</i></p> <p>Subsection 27(9) of the <i>Ontario Heritage Act</i>, with respect to a notice to the council of a municipality to the demolition or removal of a building from a registered property.</p> <p>Subsection 30(2) of the <i>Ontario Heritage Act</i>, with respect to a consent of the council of a municipality to the alteration or demolition of a building.</p> <p>Section 33 of the <i>Ontario Heritage Act</i>, with respect to the consent of the council of a municipality for the alteration of a property.</p> <p>Section 34 of the <i>Ontario Heritage Act</i>, with respect to the consent of the council of a municipality for the demolition of a building.</p> <p>By-laws made under Section 40.1 of the <i>Ontario Heritage Act</i></p> <p>Section 42 of the <i>Ontario Heritage Act</i>, with respect to the permit given by the council of a municipality for the erection, alteration, or demolition of a building.</p>	Local Municipality	
<p><i>Ontario Heritage Act:</i></p> <p>Section 34.5 of the <i>Ontario Heritage Act</i>, with respect to a consent of the Minister to the alteration or demolition of a designated building</p> <p>Subsection 34.7(2) of the <i>Ontario Heritage Act</i>, with respect to a consent of the Minister to the alteration or demolition of a designated building</p>	Ministry of Tourism, Culture and Sport	General Inquiry: ph: 416-326-9326
<p><i>Ontario Planning and Development Act, 1994,</i></p> <p>Section 14 <i>Ontario Planning and Development Act, 1994</i>, with respect to any conflict between a development plan made under that Act and a zoning by-law that affects the proposed building or structure.</p> <p>Subsection 17(1) <i>Ontario Planning and Development Act, 1994</i> with respect to orders made under that Act.</p>	Ministry of Municipal Affairs and Housing	General Inquiry: ph: 416-585-7041 Central Municipal Services Office ph: 416-585-6226 or 800-668-0230 Eastern Municipal Services Office ph: 613-545-2100 or 800-267-9438 Northeastern Municipal Services Office ph: 705-564-0120 or 800-461-1193 Northwestern Municipal Services Office ph: 807-475-1651 or 800-465-5027 Southwestern Municipal Services Office ph: 519-873-4020 or 800-265-4736

Applicable Law Provision	Responsible Agency	Contact
<p><i>Planning Act:</i> Section 33 of the <i>Planning Act</i>, except where in the case of demolition of a residential property, a permit to demolish the property is obtained under that Section By-laws made under Sections 34 or 38 of the <i>Planning Act</i>. Section 41 of the <i>Planning Act</i>, with respect to the approval by the council of the municipality of the Municipal Board of plans and drawings. Section 42 of the <i>Planning Act</i>, with respect to the payment of money to the Municipality. Section 46 of the <i>Planning Act</i>. By-laws made under O. Reg. 608/06 (Development Permits) made under the <i>Planning Act</i>. By-laws made under O. Reg. 246/01 (Development Permits) made under the <i>Planning Act</i>.</p>	Local Municipality	
<p><i>Planning Act:</i> Section 47 of the <i>Planning Act</i>, with respect to orders made under that Act.</p>	Ministry of Municipal Affairs and Housing	General Inquiry: ph: 416-585-7041 Central Municipal Services Office ph: 416-585-6226 or 800-668-0230 Eastern Municipal Services Office ph: 613-545-2100 or 800-267-9438 Northeastern Municipal Services Office ph: 705-564-0120 or 800-461-1193 Northwestern Municipal Services Office ph: 807-475-1651 or 800-465-5027 Southwestern Municipal Services Office ph: 519-873-4020 or 800-265-4736
<p><i>Public Lands Act:</i> Section 2 of O. Reg. 453/96 of the <i>Public Lands Act</i>, with respect to the work permit from the Minister authorizing the construction or placement of a building on public land.</p>	Ministry of Natural Resources and Forestry	General Inquiry ph: 800-667-1940
<p><i>Public Transportation and Highway Improvement Act:</i> Section 34 or 38 of the <i>Public Transportation and Highway Improvement Act</i>, with respect to the permit from the Minister for the placement, erection or alteration of any building or other structure or the use of land.</p>	Ministry of Transportation	General Inquiry ph: 800-268-4686 Central Region: ph: 416-235-5412 Eastern Region: ph: 800-267-0295 Northeastern Region: ph: 705-472-7900 or 800-461-9547 Northwestern Region: ph: 807-473-2000 or 800-465-5034 Southwestern Region: ph: 519-873-4335 or 800-265-6072

A-1.5.1.1.(1) Application of Referenced Documents.

Documents referenced in the Building Code may contain provisions covering a wide range of issues, including issues that are unrelated to the objectives and functional statements stated in Parts 2 and 3 of Division A respectively; e.g. aesthetic issues such as colour-fastness or uniformity. Sentence 1.5.1.1.(1) is intended to make it clear that, whereas referencing a document in the Building Code generally has the effect of making the provisions of that document part of the Code, provisions that are unrelated to buildings or to the objectives and functional statements attributed to the provisions in Division B where the document is referenced are excluded.

Furthermore, many documents referenced in the Building Code contain references to other documents, which may also, in turn, refer to other documents. These secondary and tertiary referenced documents may contain provisions that are unrelated to buildings or to the objectives and functional statements of the Building Code: such provisions - no matter how far down the chain of references they occur - are not included in the intent of Sentence 1.5.1.1.(1) of Division A.

A-2.2.1.1.(1) Objectives.

Listing of Objectives

- e9 Any gaps in the numbering sequence of the objectives are due to the fact that there is a master list of objectives covering the Building Code, Fire Code and the three principal model National Code Documents (National Building Code of Canada 2015, National Plumbing Code of Canada 2015 and National Fire Code of Canada 2015) but not all objectives are pertinent to all Codes.

The Building

Where the term “the building” is used in the wording of the objectives, it refers to the building for which compliance with the Building Code is being assessed.

Emergency

The term “emergency” - in the context of safety in buildings - is often equated to the term “fire emergency”; however, the wording of objectives OS3.7 and OS5.9 makes it clear that the Code addresses any type of emergency that would require the rapid evacuation of the building, such as the release of hazardous substances or the presence of intruders.

A-3.2.1.1.(1) Functional Statements.

Listing of Functional Statements

The numbered functional statements are grouped according to functions that deal with closely related subjects. For example, the first group deals with fire risks, the second group deals with emergency egress and response, etc. There are gaps in the numbering sequence for the following reasons:

- Each group has unused numbers which allows for the possible future creation of additional functional statements within any one group.
- e9
- There is a master list of functional statements covering the Building Code, Fire Code and the three principal model National Code Documents (National Building Code of Canada 2015, National Plumbing Code of Canada 2015 and National Fire Code of Canada 2015) but not all functional statements are pertinent to all Codes.

Explanatory Material for Division B

A-1.1.2.1.(2) Winter Design Temperatures.

The 2.5 percent values referenced in Sentence 1.1.2.1.(2) are the least restrictive temperatures that can be used. If a designer chooses to use the 1 percent values shown in MMAH Supplementary Standard SB-1, they would be in excess of the Code minimums and would be considered acceptable.

A-1.3.2.1. Abbreviations of Proper Names.

The following table provides contact information for organizations referenced in this Code:

Name	Address	Contact
ACGIH	American Conference of Governmental Industrial Hygienists 1330 Kemper Meadow Drive Cincinnati, Ohio 45240 USA	ph: 513-742-2020 fax: 513-742-3355 web site: www.acgih.org
AISI	American Iron and Steel Institute 25 Massachusetts Ave., NW Suite 800 Washington, DC 20001 USA	ph: 202-452-7100 fax: 202-452-1039 web site: www.steel.org
ANSI	American National Standards Institute 25 West 43rd Street, 4th Floor New York, New York 10036 USA	ph: 212-642-4900 fax: 212-398-0023 web site: www.ansi.org
APHA	American Public Health Association 800 I Street, NW Washington, DC 20001 USA	ph: 202-777-2742 fax: 202-777-2534 web site: www.apha.org
a10.1 ASCE	American Society of Civil Engineers 1801 Alexander Bell Drive Reston, VA 20191 USA	ph: 800-584-2723 web site: www.asce.org
ASHRAE	American Society of Heating, Refrigerating and Air-Conditioning Engineers 1791 Tullie Circle, N.E. Atlanta, Georgia 30329 USA	ph: 404-636-8400 800-527-4723 fax: 404-321-5478 web site: www.ashrae.org
ASME	The American Society of Mechanical Engineers Three Park Avenue New York, New York 10016-5990 USA	ph: 800-843-2763 fax: 973-882-1717 web site: www.asme.org
ASPE	American Society of Plumbing Engineers 6400 Shafer Court, Suite 350 Rosemont, Illinois 60018 USA	ph: 847-296-0002 fax: 847-296-2963 web site: www.aspe.org
ASSE	American Society of Sanitary Engineering 901 Canterbury Suite A Westlake, Ohio 44145 USA	ph: 440-835-3040 fax: 440-835-3488 web site: www.asse-plumbing.org
ASTM	American Society for Testing and Materials 100 Barr Harbor Drive PO Box C700 West Conshohocken, Pennsylvania 19428-2959 USA	ph: 610-832-9585 fax: 610-832-9555 web site: www.astm.org
AWS	American Welding Society 8669 NW 36th Street, Suite 130 Doral, Florida 33166 USA	ph: 800-443-9353 fax: 305-443-5647 web site: www.aws.org

Name	Address	Contact
AWWA	American Water Works Association 6666 W. Quincy Ave. Denver, Colorado 80235 USA	ph: 303-794-7711; 800-926-7337 fax: 303-347-0804 web site: www.awwa.org
BCMOHS	British Columbia Ministry of Health Population Health and Wellness, Health Protection 1515 Blanshard Street, 4th Floor Victoria, British Columbia V8W 3C8	ph: (250) 952-1469 fax: (250) 952-1713 web site: http://www.health.gov.bc.ca
BNQ	Bureau de Normalisation du Québec 333, rue Franquet Québec, Québec G1P 4C7	ph: 418-652-2238 800-386-5114 fax: 418-652-2292 web site: www.bnq.qc.ca
CCBFC	Canadian Commission on Building and Fire Codes National Research Council Canada Building M-23A 1200 Montreal Road Ottawa, Ontario K1A 0R6	ph: 613-993-9960 fax: 613-952-4040 web site: www.nationalcodes.ca
CGSB	Canadian General Standards Board 11 Laurier Street Gatineau, Quebec K1A 1G6	ph: 819-956-0425 800-665-2472 fax: 819-956-5740 web site: www.pwgsc.gc.ca/cgsb
CSA	Canadian Standards Association 5060 Spectrum Way, Suite 100 Mississauga, Ontario L4W 5N6	ph: 416-747-4044 800-463-6727 fax: 416-747-2510 web site: www.csa.ca
CWC	Canadian Wood Council 99 Bank Street, Suite 400 Ottawa, Ontario K1P 6B9	ph: 613-747-5544 800-463-5091 fax: 613-747-6264 web site: www.cwc.ca
DBR	Institute for Research in Construction National Research Council Canada Building M-23A 1200 Montreal Road Ottawa, Ontario K1A 0R6 <i>The Division of Building Research (DBR) is now known as the Institute for Research in Construction.</i>	ph: 613-993-9960 fax: 613-952-4040 web site: www.nationalcodes.ca
EPA	Environmental Protection Agency Ariel Rios Building 1200 Pennsylvania Avenue, N.W. Washington, DC 20460 USA	ph: (202) 272-0167 web site: www.epa.gov
FINA	Fédération Internationale de Natation Avenue de l'Avant-Poste No 4 CH-1005 Lausanne, Switzerland	ph: (+41-21) 310-47-10 fax: (+41-21) 312-66-10 web site: www.fina.org
a10.1 GRHC	Green Roofs for Healthy Cities 406 King Street East Toronto, Ontario M5A 1L4	ph. 416-971-4494 web site: www.greenroofs.org
HC	Health Canada Address Locator 0900C2 Ottawa, Ontario K1A 0K9	ph: 866-225-0709 fax: 613-941-5366 web site: www.hc-sc.gc.ca

Name	Address	Contact
HI	Hydronics Institute Division of GAMA 35 Russo Place P.O. Box 218 Berkeley Heights, New Jersey 07922 USA <i>The Hydronics Institute was formally merged into GAMA in 2004.</i>	ph: 866-408-3831 908-464-8200 fax: 908-464-7818 web site: www.gamanet.org
a10.1 HPVA	Hardwood Plywood & Veneer Association (Now Decorative Hardwoods Association) 42777 Trade West Dr Sterling, VA 20166 USA	ph: 703-435-2900 fax: 703-435-2573 web site: decorativehardwoods.org
HRAI	Heating, Refrigerating and Air-Conditioning Institute of Canada 2800 Skymark Avenue Building 1, Suite 201 Mississauga, Ontario L4W 5A6	ph: 905-602-4700 800-267-2231 fax: 905-602-1197 web site: www.hrai.ca
HVI	Home Ventilating Institute 1000 N. Rand Rd. Suite 214 Wauconda, Illinois 60084 USA	ph: 847-526-2010 fax: 847-526-3993 web site: www.hvi.org
as IAPMO	International Association of Plumbing and Mechanical Officials 4755 E. Philadelphia St. Ontario, California 91761 USA	ph: 909-472-4100 fax: 909-472-4150 web site: iampo.org
IESNA	Illuminating Engineering Society of North America 120 Wall Street, Floor 17 New York, New York 10005-4001 USA	ph: 212-248-5000 fax: 212-248-5017 web site: www.iesna.org
ISO	International Organization for Standardization ISO Central Secretariat 1, ch. de la Voie-Creuse CP 56 CH-1211 Geneva 20, Switzerland	ph: 41-22-749-01-11 fax: 41-22-733-34-30 web site: www.iso.org
HUD	U.S. Department of Housing and Urban Development <i>HUD established HUD USER as the primary source of US government technical housing publications.</i> HUD USER P.O. Box 23268 Washington, DC 20026-3268 USA	ph: 202-708-3178 800-245-2691 fax: 202-708-9981 web site: www.huduser.org
as MMA (now MMAH)	Ontario Ministry of Municipal Affairs (Ontario Ministry of Municipal Affairs and Housing) 777 Bay Street, 17th Floor Toronto, Ontario M5G 2E5	ph: 416-585-7041 fax: 416-585-6470 web site: www.ontario.ca/buildingcode
as MOE (now MECP)	Ontario Ministry of the Environment (Ontario Ministry of the Environment and Climate Change) (Ontario Ministry of the Environment, Conservation and Parks) 135 St Clair Avenue West Toronto, Ontario M4V 1P5	ph: 416-325-4000 fax: 416-314-6713 web site: www.ontario.ca/ministry-environment-conservation-parks
NFPA	National Fire Protection Association 1 Batterymarch Park Quincy, Massachusetts 02169-7471 USA	617-770-3000 fax: 617-770-0700 web site: www.nfpa.org
a10.1 NFRC	National Fenestration Rating Council 6305 Ivy Lane, Suite 140 Greenbelt, MD 20770, USA	ph: 301-589-1776 fax: 301-589-3884 web site: www.nfrc.org

Name	Address	Contact
NLGA	National Lumber Grades Authority #302 -960 Quayside Drive, New Westminster, British Columbia V3M 6G2	ph: 604-524-2393 fax: 604-524-2893 web site: www.nlga.org
NRCan	Natural Resources Canada Office of Energy Efficiency 580 Booth St., 18th Floor Ottawa, Ontario K1A 0E4	ph: 613-995-2943 800-387-2000 web site: www.nrcan-rncan.gc.ca
NSF	NSF International P.O. Box 130140 789 N. Dixboro Road Ann Arbor, Michigan 48113-0140 USA	ph: 734-769-8010 fax: 734-769-0109 web site: www.nsf.org
a10.1 SEI	See ASCE	
SMACNA	Sheet Metal and Air Conditioning Contractors National Association Inc. 4201 Lafayette Center Drive Chantilly, Virginia 20151-1219 USA	ph: 703-803-2980 fax: 703-803-3732 web site: www.smacna.org
a10.1 SPRI	Single Ply Roofing Industry 465 Waverley Oaks Road Suite 421 Waltham, MA 02452	ph: 781-647-7026 fax: 781-647-7222 web site: www.spri.org
TC	Transport Canada 330 Sparks Street Ottawa, Ontario K1A 0N5	ph: 613-990-2309 866-995-9737 fax: 613-954-4731 web site: www.tc.gc.ca
TPIC	Truss Plate Institute of Canada c/o Jager Metal Products, #220 6223 2nd Street East, Calgary, Alberta T2H 1J5 <i>The TPIC, "Truss Design Procedures and Specifications for Light Metal Plate Connected Wood Trusses" is available on-line at: the TPIC web site at: www.tpic.ca.</i>	web site: www.tpic.ca.
UL	Underwriters Laboratories Inc. 333 Pfingsten Road Northbrook, Illinois 60062-2096 USA	ph: 847-272-8800 web site: www.ul.com
ULC	Underwriters' Laboratories of Canada 7 Underwriters Road Toronto, Ontario M1R 3A9	ph: 866-937-3852 fax: 416-757-8727 web site: www.ulc.ca
USDA	United States Department of Agriculture 1400 Independence Ave., S.W. Washington, DC 20250 USA	web site: www.usda.gov
WEF	Water Environment Federation 601 Wythe Street Alexandria, Virginia 22314-1994 USA	ph: 800-666-0206 fax: 703-684-2492 web site: www.wef.org
a9 WT	Waterfront Toronto 20 Bay Street, Suite 1310 Toronto, Ontario M5J 2N8	ph: 416-214-1344 fax: 416-244-4591 web site: info@waterfronttoronto.ca

e3 A-3 Application of Part 3.

In applying the requirements of this Part, it is intended that they be applied with discretion to buildings of unusual configuration that do not clearly conform to the specific requirements, or to buildings in which processes are carried out which make compliance with particular requirements in this Part impracticable.

The definition of “building” as it applies to this Code is general and encompasses most structures, including those which would not normally be considered as buildings in the layman’s sense. This occurs more often in industrial uses, particularly those involving manufacturing facilities and equipment that require specialized design that may make it impracticable to follow the specific requirements of this Part. Steel mills, aluminum plants, refining, power generation and liquid storage facilities are examples. A water tank or an oil refinery, for example, has no floor area, so it is obvious that requirements for exits from floor areas would not apply.

Requirements for structural fire protection in large steel mills and pulp and paper mills, particularly in certain portions, may not be practicable to achieve in terms of the construction normally used and the operations for which the space is to be used. In other portions of the same building, however, it may be quite reasonable to require that the provisions of this Part be applied (e.g., the office portions). Similarly, areas of industrial occupancy which may be occupied only periodically by service staff, such as equipment penthouses, normally would not need to have the same type of exit facility as floor areas occupied on a continuing basis.

a3 Firefighting Assumptions

The requirements of this Part are based on the assumption that firefighting capabilities are available in the event of a fire emergency. These firefighting capabilities may take the form of a paid or volunteer public fire department or, in some cases, a private fire brigade. If these firefighting capabilities are not available, additional fire safety measures may be required.

Firefighting capability can vary from municipality to municipality. Generally, larger municipalities have greater firefighting capability than smaller ones. Similarly, older, well established municipalities may have better firefighting facilities than newly formed or rapidly growing ones. The level of municipal fire protection considered to be adequate will normally depend on both the size of the municipality (i.e., the number of buildings to be protected) and the size of buildings within that municipality. Since larger buildings tend to be located in larger municipalities, they are generally, but not always, provided with a higher level of municipal protection.

Some level of municipal firefighting capability was assumed in developing many of the fire safety provisions in Part 3. The requirements in the Code, while developed in the light of commonly prevailing municipal fire protection levels, do not attempt to relate the size of building to the level of municipal protection. The responsibility for controlling the maximum size of building to be permitted in a municipality in relation to local firefighting capability rests with the municipality.

The municipality may, in light of its firefighting capability, elect to introduce zoning restrictions to ensure that the maximum building size is related to available municipal fire protection facilities. This decision should be made in consultation with the local firefighting service, who are aware of their capability to fight fires.

The requirements of Subsection 3.2.3. are intended to prevent fire spread from thermal radiation assuming there is adequate firefighting available. It has been found that periods of from 10 to 30 minutes usually elapse between the outbreak of fire in a building that is not protected with an automatic sprinkler system and the attainment of high radiation levels. During this period, the specified spatial separations are intended to inhibit ignition of an exposed building face or the interior of an adjacent building by radiation. Subsequently, however, reduction of the fire intensity by firefighting and the protective wetting of the exposed building face will often be necessary as supplementary measures to inhibit fire spread.

In the case of a building that is sprinklered, the automatic sprinkler system is intended to control the fire to an extent that radiation to neighbouring buildings should be minimal. Although there will be some radiation effect on a sprinklered building from a fire in a neighbouring building, the internal sprinkler system should control any fires that might be ignited in the building and thereby minimize the possibility of the fire spreading into the exposed building. NFPA 80A, “Recommended Practice for Protection of Buildings from Exterior Fire Exposures”, provides additional information on the possibility of fire spread at building exteriors.

The water supply requirements for fire protection installations depend on the requirements of any automatic sprinkler installations and on the number of fire streams that may be needed at any fire, having regard to the length of time the streams will have to be used. Both these factors are largely influenced by the conditions at the building to be equipped, and the quantity and pressure of water needed for the protection of both the interior and exterior of the building. These considerations must be ascertained before the water supply is decided upon.

Acceptable water supplies may be:

- a public waterworks system that has adequate pressure and discharge capacity,
- automatic fire pumps,
- pressure tanks,
- manually controlled fire pumps in combination with pressure tanks,
- gravity tanks, and/or
- manually controlled fire pumps operated by remote control devices at each hose station.

(See also A-3.2.5.7. Water Supply)

A-3.1.2. Use Classification.

The purpose of classification is to determine which requirements apply. This Code requires classification in accordance with every major occupancy for which the building is used or intended to be used. Where necessary, an application clause has been inserted in this Part to explain how to choose between the alternative requirements that multiple occupancy classification may present.

A-3.1.2.1.(1) Major Occupancy Classification.

The following are only examples of the major occupancy classifications described in Table 3.1.2.1. To ensure the correct classification, refer to the definitions for each occupancy in Part 1 of Division A.

Group A, Division 1

Motion picture theatres
Opera houses
Television studios admitting a viewing audience
Theatres, including experimental theatres

Group A, Division 2

Art galleries
Auditoria
Bowling alleys
Child care facility
Churches and similar places of worship
Clubs, nonresidential
Community halls
Courtrooms
Dance halls
Exhibition halls (other than classified in Group E)
Gymnasias
Lecture halls
Libraries
Licensed beverage establishments
Museums
Passenger stations and depots
Recreational piers
Restaurants
Schools and colleges, nonresidential
Undertaking premises

Group A, Division 3

Arenas
Indoor swimming pools
Rinks

Group A, Division 4

Amusement park structures (not elsewhere classified)
Bleachers
Grandstands
Reviewing stands
Stadia

Group B, Division 1

Jails
Penitentiaries
Police stations with detention quarters
Prisons
Psychiatric hospitals with detention quarters
Reformatories with detention quarters

Group B, Division 2

Facilities for people with developmental disabilities
Homes for the aged
Hospitals
Infirmaries
Long term care
Nursing homes
Psychiatric hospitals without detention quarters
Reformatories without detention quarters
Sanatoria without detention quarters

Group B, Division 3 (See also Sentence 3.1.2.5.(1).)

Children's custodial homes
Convalescent homes
Group homes for people with developmental disabilities
Residential care facilities
Sanatoria without detention quarters

Group C

Apartments
Boarding houses
Camps for housing workers
Clubs, residential
Colleges, residential
Convents
Dormitories
Group homes
Halfway houses, drug and alcohol treatment
Hostels
Hotels
Houses
Lodging houses
Monasteries
Motels
Open and semi-secure detention for youth
Recreational camps
Rooming houses
Schools, residential
Shelters for homeless
Shelters for women

Group D

Banks
Barber and hairdressing shops
Beauty parlours
Dental offices
Dry cleaning establishments, self-service, not using flammable or explosive solvents or cleaners
Laundries, self-service
Medical offices
Offices
Police stations without detention quarters
Radio stations
Small tool and appliance rental and service establishments

Group E

Department stores
Exhibition halls
Markets
Restaurants with an occupant load not more than 30 persons consuming food and drink
Shops
Stores
Supermarkets

Group F, Division 1

Bulk plants for flammable liquids
Bulk storage warehouses for hazardous substances
Cereal mills
Chemical manufacturing or processing plants
Distilleries
Dry cleaning plants using flammable or explosive solvents or cleaners
Feed mills
Flour mills
Grain elevators
Lacquer factories
Paint, varnish and pyroxylin product factories
Rubber processing plants
Spray painting operations

Group F, Division 2

Aircraft hangars
Cold storage plants
Dry cleaning establishments not using flammable or explosive solvents or cleaners
Electrical substations
Freight depots
Helicopter landing areas on roofs
Laboratories
Laundries, except self-service
Planing mills
Printing plants
Repair garages
Self-service storage buildings
Service stations
Storage rooms
Television studios not admitting a viewing audience
Tire storage
Warehouses
Woodworking factories

Group F, Division 3

Creameries
Laboratories
Power plants
Storage garages, including open air parking garages
Storage rooms
Warehouses

A-3.1.3.2.(3) Food Premises.

This requirement is intended to apply to facilities where food is being prepared, stored, processed or served, such as restaurants, commercial kitchens, cafeterias, camps, milk plants and bakeries.

a10.1 A-3.1.4.1.(1) Combustible Construction and Materials Permitted.

The permission to use combustible construction or combustible materials stated in Articles 3.1.4.1., 3.1.5.5., 3.1.5.12., and 3.1.5.12A. does not waive the requirements regarding construction type and cladding stated in Article 3.2.3.7.

a10.1 A-3.1.4.2. Protection of Penetrations.

Where foamed plastics are required to be protected from adjacent spaces within a building, the protection should be continuous so as to cover the foamed plastics so they are not exposed to the interior of the building. However, minor penetrations of the protective covering by small electrical and mechanical components, such as electrical outlets and fixtures, sprinkler piping, and mechanical vents, are acceptable because the penetrant and associated fittings and seals will prevent the small amount of foamed plastic surrounding the penetration from being exposed to the interior of the building.

Foamed plastics that are penetrated by larger components or assemblies, such as windows, are unlikely to be exposed to the interior of the building as they are protected by associated framing and finishes and/or the installation of a closure.

Small amounts of foamed plastics, such as air sealants used between major components of exterior wall construction, are not required to be protected (see Sentence 3.1.5.2.(1)).

Penetrations of a fire separation or of a membrane forming part of an assembly required to have a fire-resistance rating are nevertheless required to be provided with a fire stop in accordance with Subsection 3.1.9.

A-3.1.4.2.(1)(c) Thermal Barrier in Combustible Construction.

Any thermal barrier that is accepted under the requirements of Sentence 3.1.5.12.(2) for noncombustible construction is also acceptable for combustible construction.

a10.1 A-3.1.4.2.(1) Concealed Space.

The term “concealed space” includes any space that is not visibly apparent and that is provided with an opening to allow access for repair and periodic inspections.

a10.1 A-3.1.4.2.(3) & A-3.1.5.5A.(3) Walk-in Coolers and Freezers.

Sentences 3.1.4.2.(3) and 3.1.5.5A.(3) are intended to apply to walk-in coolers and freezers that are constructed as stand-alone structures within a building.

A-3.1.4.3. Wire and Cable Equivalence.

Electrical wires and cables that conform to the requirements of Sentence 3.1.5.18.(1) are deemed to satisfy the requirements of Sentence 3.1.4.3.(1).

A-3.1.4.3.(1)(b)(i) Raceway Definition.

The term raceway is defined in Ontario Electrical Safety Code and includes both rigid and flexible conduit.

A-3.1.5.4.(1) Skylight Spacing.

The minimum spacing dimensions for skylight assemblies are based on the distance that flame must travel along a flat ceiling surface. If ceilings have projecting beams or other features that would increase the distance the flame would have to travel along the surface, the distances specified may be measured accordingly.

A-3.1.5.5.(1) Combustible Elements.

These requirements allow for exterior wall assemblies incorporating combustible elements on buildings of noncombustible construction. Since the tested assemblies must be representative of actual construction, the performance of the entire assembly is assessed with regard to its ability to resist flame propagation up the outside of a building. The thermal barrier protection limits the impact of an interior fire on the wall assembly.

These requirements, in combination, thus allow for wall assemblies containing both combustible cladding elements and non-loadbearing combustible framing members. These wall assemblies can be used as infill or panel type walls between structural elements, or attached directly to a loadbearing noncombustible structural system. These requirements, however, do not waive others specifically intended for the protection of combustible insulation in buildings of noncombustible construction.

These requirements are predicated upon the assumption that the manufacturing process and field installation procedure are both carried out under an independent quality assurance program designed to confirm that the product and its application are consistent with the system as tested.

a10.1 A-3.1.5.5.(1)(b)(i) Flame-Spread Distance.

The maximum flame-spread distance referred to in Subclause 3.1.5.5.(1)(b)(i) means the distance between the top of the opening and the highest observable instance of flaming along the wall assembly; thus, intermittent flaming to a height of 5 m above the opening is acceptable.

a10.1 A-3.1.5.5.(1)(b)(ii) Heat Flux Measurement.

The heat flux to the assembly referred to in Subclause 3.1.5.5.(1)(b)(ii) is the maximum one-minute averaged heat flux measured by transducers located 3.5 m above the top of the opening. The intent of this criterion is to limit the spread of fire on the wall assembly to a height of 3.5 m above the opening.

Fire tests have shown that flame does not spread on the exterior surface of a wall assembly where the heat flux is less than 35 kW/m² above the opening.

e7 A-3.1.5.12A.(2)(e) Foamed Plastic Insulation Protection.

The standard fire exposure temperature in CAN/ULC-S101, “Fire Endurance Tests of Building Construction and Materials”, is the same as in CAN/ULC-S124, “Test for the Evaluation of Protective Coverings for Foamed Plastic”. A thermal barrier that, when tested in conformance with CAN/ULC-S101, “Fire Endurance Tests of Building Construction and Materials”, will not exceed an average temperature rise of 140°C on its unexposed face after a period of 10 min satisfies this requirement.

A-3.1.5.18.(1) Wire and Cable Flammability.

In regulating the flammability characteristics of optical fibre cables and electrical wires and cables installed in a building, it is intended that the requirements of this Sentence and of other similar Sentences in the Code apply to wires and cables that are essentially a part of the distribution systems for power or communications. These distribution systems will normally include branch circuits that terminate at an outlet box in the space to be served and, at that location, cable terminators or plugs for individual items of equipment will be plugged in.

A-3.1.8.1.(1)(b) Barrier to Control Smoke Spread.

Although a fire separation is not always required to have a fire-resistance rating, the fire separation should act as a barrier to the spread of smoke and fire until some response is initiated.

When choosing products for the fire stopping, the physical characteristics of the material used at the joints as well as the nature of the assembly and its potential movement should be taken into consideration.

If the fire-resistance rating of a fire separation is waived on the basis of the presence of an automatic sprinkler system, it is intended that the fire separation will be constructed so that it will remain in place and act as a barrier against the spread of smoke for a period of time until the sprinklers have actuated and controlled the fire.

A-3.1.8.1.(2) Installation of Closures.

Although there is no explicit performance statement in the Code that means of egress should be free of smoke, it is the intent that during the period when occupants are using a means of egress to evacuate from a floor area, the smoke contamination should not reach levels that would inhibit movement to the exit. This is particularly critical for persons with disabilities, who may not move at the same rate as other persons and who could be more susceptible to the effects of smoke contamination. NFPA 80, “Fire Doors and Other Opening Protectives”, requires that a fire door protecting a means of egress be designed to minimize the possibility of smoke passing through the opening.

Although self-closing devices are not required for all doors in a fire separation (see Article 3.1.8.11.), it is assumed that in a fire situation every door in a fire separation is closed. Article 3.3.3.5. prohibits grilles and similar openings for certain fire separations in hospitals and long term care homes.

Although fire dampers that release on the fusion of a fusible link will help to control the spread of fire, a substantial quantity of smoke could have passed through the opening before that event. They are frequently located below the upper levels of a room and so the release of the fusible link of the fire damper that protects an opening will be delayed until the temperature at the level of the opening becomes high enough to fuse the link.

Similar concern has to be considered for other closure devices that are permitted to remain open on fusible links, and their location should be restricted in accordance with NFPA 80, “Fire Doors and Other Opening Protectives”, and this Code, except where their installation in another location will not allow the products of combustion to spread into means of egress.

A-3.1.8.3.(4) Fire Separation Continuity.

The continuity of a fire separation where it abuts against another fire separation, a floor, a ceiling or an exterior wall assembly is maintained by filling all gaps at the juncture of the assemblies with a material that will ensure the integrity of the fire separation at that location.

a10.1 A-3.1.8.9.(3) Combination Smoke/Fire Dampers.

A combination smoke/fire damper may be used in lieu of a fire damper to meet the requirement of Sentence 3.1.8.9.(2).

A-3.1.8.9.(5) Fire Damper Access.

It is intended that an access door be provided in the duct and, if the duct is enclosed with an architectural finish, that a second access door be provided through that finish.

A-3.1.8.16.(1) Wired Glass and Glass Block.

The permission to include wired glass and glass block in doors and fire separations between an exit and the adjacent floor area does not permit the inclusion of those items in fire separations between exits and other parts of the building that are not included in the floor area. Examples include other exit facilities and vertical service spaces, including those used for building services and elevator hoistways.

A-3.1.8.17.(1) Fire-Protection Rating for Doors.

The provisions in Articles 3.1.8.15. to 3.1.8.17. do not waive a requirement for a door to have a fire-protection rating. To achieve this rating in a door test, it may be necessary to limit the area of glass in the door. If this area is less than the area limits of Article 3.1.8.16., it is the governing criterion. Conversely, if the area limits of Article 3.1.8.16. are less than the area required to achieve a fire-protection rating, then the area limits of this Article govern.

A-3.1.9. Penetrations.

In the application of Subsection 3.1.9., a building service is considered to penetrate an assembly if it passes into or through the assembly. In some situations a service item enters an assembly through a membrane at one location, runs within the assembly, and then leaves the assembly through a membrane at another location.

The term “membrane penetration” usually designates an opening made through one side (wall, floor or ceiling membrane) of an assembly, whereas the term “through-penetration” designates an opening that passes through an entire assembly. Fire stopping of membrane penetrations involves installing a material, device or assembly to resist for a prescribed time period the passage of flame and heat through the openings in a protective membrane caused by cables, cable trays, conduit, tubing, pipes or similar items. Fire stopping of a through-penetration involves installing an assembly of specific materials or products that are designed, tested and fire-resistance rated to resist for a prescribed period of time the spread of fire through penetrations.

Products for fire stopping within a barrier are required to address movement of the assembly and to control smoke spread; as such, the flexibility of the material used at the flexible joints as well as the nature of the assembly and its potential movement must be taken into consideration.

A-3.1.9.1.(1)(b) Tightly Fitted.

The intention behind the use of the term “tightly fitted” is to reinforce that there are to be no gaps between the building service or other penetrating item and the membrane or assembly it penetrates. A typical means of fire stopping for a service or other penetration through a concrete slab or wall is “cast in place” concrete.

A-3.1.9.2.(1) Penetration of Fire Separations by Electrical Boxes.

The provisions dealing with outlet boxes assume size, quantities and concentrations of partial depth penetrations that would not significantly affect the fire resistance of the assembly, including the temperature rise on the unexposed side of a wall. Sentence 3.1.9.2.(1) is not intended to allow large electrical distribution and control boxes to be recessed into an assembly required to have a fire-resistance rating unless they were incorporated in the assembly at the time of testing.

Electrical boxes used as junction boxes, for lighting fixtures and communication cable should be treated in a similar manner.

a10.1 A-3.1.9.3A. Outlet Boxes.

For the purposes of Article 3.1.9.3A., outlet boxes include, but are not limited to, electrical boxes, junction boxes, high and low voltage outlets, switches, enclosures for electrical equipment, laundry boxes, and shower diverters.

A-3.1.9.4.(1) Combustible Piping Penetrations.

The use of combustible pipe for sprinkler systems, water supply, drains or other services is governed by other requirements in Part 3. This Article regulates the use of combustible piping through penetrations of fire separations or a membrane that forms part of an assembly that is required to have a fire-resistance rating. Where permitted by this Article, combustible pipe may penetrate a fire separation or a membrane that forms part of an assembly that is required to have a fire resistance rating.

A-3.1.10.2.(4) Firewall Construction.

Inherent in the use of a firewall is the intent that this specialized wall construction provide the required fire-resistance rating while also being designed to resist physical damage - arising out of normal use - that would compromise the rating of the assembly. Traditionally, this has been accomplished by prescribing the use of noncombustible materials, which was, in fact, restricted to concrete or masonry. Sentences 3.1.10.2.(3) and (4) are intended to retain both of the characteristics of firewalls, while permitting greater flexibility in the use of materials and designs. The fire-resistance rating and damage protection attributes of a firewall may be provided by a single fire- and damage-resistant material such as concrete or masonry, by a fire- and damage-resistant membrane on a structural frame, or by separate components - one that provides the fire-resistance rating and another one that protects the firewall against damage.

If the firewall is composed of separate components, the fire-resistance rating of the fire-resistive component needs to be determined for this assembly on its own. In addition, if the damage protection component is physically attached to the fire-resistive component (for example, as a sacrificial layer), then, for the purposes of determining the overall performance of the assembly, it is also necessary to determine through testing whether failure of the damage protection component during a fire affects the performance of the fire-resistive component.

a10.1 A-3.1.11.5.(1) Fire Blocks in Combustible Construction.

Combustible construction referred to in Sentence 3.1.11.5.(1) includes all types of construction that do not comply with the requirements for noncombustible construction. All of the elements within the concealed space can be combustible, unless required to be of noncombustible materials (e.g., certain categories of pipework and ducts). However, the value of the flame-spread rating of the combustible materials determines the permitted extent of the concealed space between fire blocks. The materials to be considered should include all construction materials regulated by this Code, including the framing and building services that are located in the concealed space. When designing fire blocking, consideration should be given to avoid restricting venting capabilities within concealed spaces. (See also Note A-5.6.2.1.)

a10.1 A-3.1.11.5.(3) Fire Blocks in Concealed Spaces.

To reduce the risk of fire spread in combustible concealed spaces within the types of buildings referred to in Sentence 3.1.11.5.(3), fire blocking is required regardless of whether the horizontal concealed space is protected by sprinklers or not, unless the space is filled with noncombustible insulation so that any air gap at the top of the insulation is very small. See also Note A-3.1.11.5.(1) for roof venting.

A 5- or 6-storey building constructed in accordance with Article 3.2.2.50. and buildings constructed in accordance with Article 3.2.2.58. are required to be sprinklered in accordance with NFPA 13, "Installation of Sprinkler Systems" (see Article 3.2.5.12.). NFPA 13 generally requires sprinklering of any concealed spaces of combustible construction or where large amounts of combustibles are present. However, NFPA 13 allows combustible concealed spaces to be unsprinklered in certain cases, including where concealed spaces are filled almost entirely with noncombustible insulation, where spaces contain only materials with a low flame-spread rating, and where limited access or the size of the space makes it impractical to install sprinklers. For certain types of construction in unsprinklered combustible concealed spaces, NFPA 13 mandates fire blocking beyond the minimum specified in Sentence 3.1.11.5.(3).

A-3.1.11.7.(6) Integrity of Fire Blocks.

Sentence 3.1.11.7.(6) together with Article 3.1.9.1., is intended to ensure that the integrity of fire blocks is maintained at areas where they are penetrated. This requirement is satisfied by the use of generic fire stops such as mineral wool, gypsum plaster or Portland cement mortar, as well as rated fire stops.

A-3.1.13.2.(2) Folding Partition.

Folding partitions used to divide a space into separate rooms are not considered as doors for the purposes of this Sentence.

A-3.1.15.1.(1) Roof Covering.

The tests described in CAN/ULC-S107 are intended to measure the relative fire-performance of roof coverings when exposed to a fire originating from sources outside the building. When metal deck or a similar noncombustible rigid roof surface is directly exposed to the exterior (a covering material on its exterior surface has not been provided), the requirements of this Sentence need not apply.

a10 A-3.1.21.1. Reserved.

a3 A-3.2.1.1.(3)(a) Mezzanine Area.

The permitted area of the mezzanine for the purposes of determining the allowable percentage is to be based on the open area of the floor of the space in which the mezzanine is located. The Code does not restrict the enclosing of space below the mezzanine. However, the enclosed area must be deducted from the area of the overall space before applying the percentage allowance.

A-3.2.1.1.(9) Accessible Service Space.

These service spaces are often referred to as interstitial spaces and are designed to allow service personnel to enter and undertake maintenance or installation within the space. Catwalks or flooring are usually included to provide a walking or access surface. Even when flooring is included, it is not intended that the interstitial space should be considered as a storey for the purposes of the Code unless the space is used for purposes other than servicing or the storage of materials and equipment to be used for building services within that space.

A-3.2.2.2.(1) Special and Unusual Structures.

Examples of structures which cannot be identified with the descriptions of buildings in Articles 3.2.2.20. to 3.2.2.83. include grain elevators, refineries and towers. Publications that may be consulted to establish good engineering practice for the purposes of Article 3.2.2.2. include the NFPA Fire Protection Handbook, Factory Mutual Data Sheets, and publications of the Society for Fire Protection Engineering.

A-3.2.2.18.(1) Sprinkler Extent.

It is not the intent of Article 3.2.2.6. and Sentences 3.2.2.4.(1) and (2) to require the installation of an automatic sprinkler system throughout all storeys of a building regardless of the options in Articles 3.2.2.20. to 3.2.2.83. in order to construct one or more storeys without the installation of sprinklers.

Furthermore, unlike the model National Building Code, it is not the intent of this Code to require an automatic sprinkler system in storeys below a storey where an automatic sprinkler system is required. Similarly, if the uppermost storey or storeys of a building can be constructed without the installation of an automatic sprinkler system it is not necessary that an automatic sprinkler system required in a lower storey be extended into the upper storey or storeys.

a3 A-3.2.2.43A.(5) and A-3.2.2.50A.(4) Five- and Six-Storey Buildings of Combustible Construction.

This Sentence and the exemptions noted in Sentences 3.2.2.6.(1) and 3.2.2.7.(1) permit a building within the scope of Articles 3.2.2.43A. and 3.2.2.50A. to be entirely of combustible construction and include certain assembly and mercantile occupancies and storage garages below the third storey.

A-3.2.3. Fire Protection Related to Limiting Distance Versus Separation Between Buildings.

Building Code provisions that address protection against fire spread from building to building use the limiting distance (see definition in Article 1.4.1.2. of Division A) for a building rather than using the distance between adjacent buildings on separate properties, so that the design and construction of a building on one property does not affect the design and construction of a building on an adjacent property.

The Building Code requirements that deal with reducing the probability of building-to-building fire spread were originally developed based on the assumption that the exposing building faces of the adjacent buildings are of similar size and configuration, and are equidistant from the shared property line. Where the buildings are of different sizes, the smaller building may be subject to a higher heat flux in the event of a fire compared to the larger building. Where the buildings are closely spaced and not equidistant from the property line, the construction of the building with the greater limiting distance does not recognize the proximity of the building with the lesser limiting distance.

The Building Code has more stringent requirements for buildings having lesser limiting distance with regards to the maximum area and spacing of unprotected openings, and the construction, cladding and fire resistance of walls. This increased stringency recognises that the fire hazard is greater where the buildings are close together and that adjacent buildings may have exposing building faces of different sizes, configurations or limiting distances, which could further increase the hazard.

The enforcement authority may also address limiting distances through legal agreements with parties involved that stipulate that the limiting distance be measured to a line that is not the property line. Such agreements would normally be registered with the titles of both properties.

A-3.2.3.1.(4) Spatial Separation Design.

In the application of Sentences 3.2.3.1.(3) and (4), it is intended that Sentence (3) be used first to establish the basic requirements for the exterior wall in terms of fire-resistance rating, type of construction and type of cladding. The percentage of unprotected openings determined from the application of Sentence (3) would be unnecessarily restrictive if the actual unprotected openings occur in a plane that is set back from the front of the building face.

Sentence (4) applies to the calculation of the allowable percentage of unprotected openings based upon projection onto a plane that is in front of all unprotected openings. The application of these two Sentences is shown in Figure A-3.2.3.1.(4). The modifications permitted by Article 3.2.3.12. would be applied, if applicable, to the area of unprotected openings derived from Sentence (4).

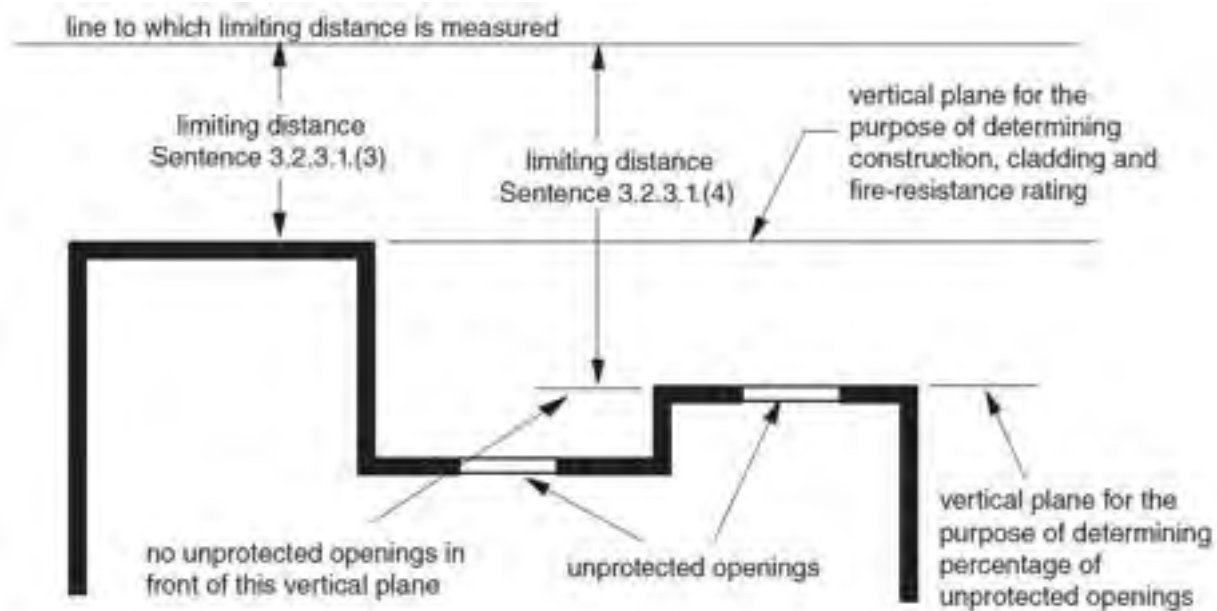


Figure A-3.2.3.1.(4)
Spatial Separation Design

A-3.2.3.6.(2) Protection of Roof Soffits Near Property Lines.

Sentences 3.2.3.6.(2) to (4) provide requirements for the protection of soffits where the soffit of the subject building is located close to the property line or to an imaginary line between two buildings on the same property. Fire from inside the roof space of the subject building can exit unprotected soffits and expose the adjacent building to flames.

A-3.2.3.12.(1) Increased Openings Permitted.

No increase of the maximum area of unprotected openings in an exposing building face should be applied until the requirements of Article 3.2.3.7. have been satisfied in determining the construction of the exposing building face.

A-3.2.3.14. Wall Exposed to Another Wall.

The intent of this Article is to ensure that the control of fire spread by the interior fire separations between adjacent fire compartments is not defeated through the spread of fire by thermal radiation outside the building. Minimum separations (D_o) are specified between unprotected openings in separate fire compartments of the building where the exterior faces of these compartments are deemed to expose each other to a thermal radiation hazard. This situation may arise where the angle, θ , between the intersecting planes of the exposing building faces is less than 135° and both of these faces have unprotected openings. The exterior walls of the fire compartments do not have to intersect in order to apply Article 3.2.3.14. Rather, the critical factor is the angle, θ , between the planes formed by the exterior walls. Examples are shown in Figures A-3.2.3.14.A., A-3.2.3.14.B. and A-3.2.3.14.C. of situations which would be addressed by this Article.

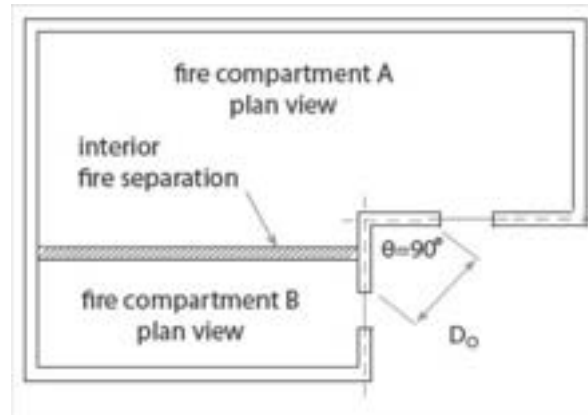


Figure A-3.2.3.14.A.
Openings in Walls at a Right-Angle Corner

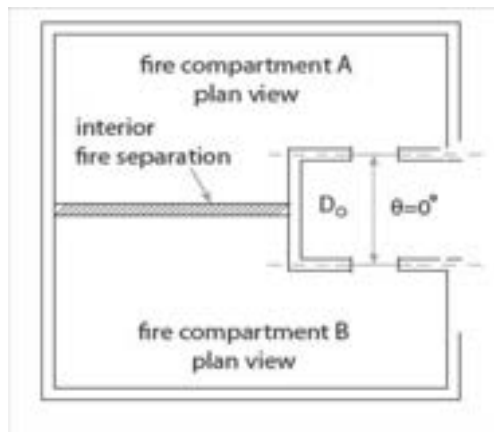


Figure A-3.2.3.14.B.
Openings in Walls which are Parallel to One Another

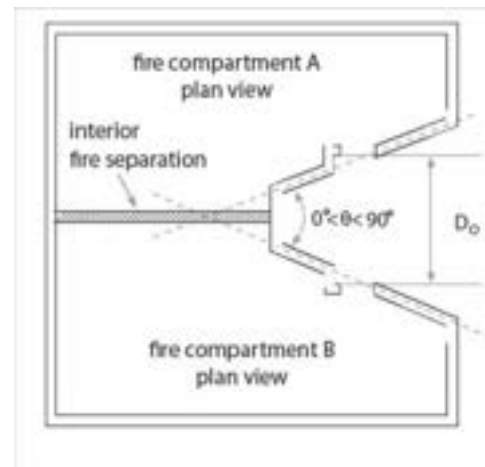


Figure A-3.2.3.14.C.
Openings in Walls with an Included Angle
of 45 Degrees

The exterior unprotected openings in the fire compartments are not deemed to expose each other to a thermal radiation hazard if:

- the angle formed between the planes of the exposing building faces is 135° or more, or
- the fire compartments are sprinklered.

In order to apply Sentence 3.2.3.14.(1), both of the exterior walls must have unprotected openings. Sentence (1) does not apply where the exterior wall of only one fire compartment has unprotected openings. The separation of exterior unprotected openings in adjacent fire compartments is not required if the openings in both compartments are in the same plane ($\theta = 180^\circ$).

Sentence 3.2.3.14.(2) requires the exterior walls of each fire compartment within the distance, D_o to have a fire-resistance rating. The fire-resistance rating must be at least equal to the required interior separation between the fire compartments. Thermal radiation from an opening is substantially reduced at angles less than 45° from the plane of the unprotected opening. This may be shown schematically in Figure A-3.2.3.14.D.:

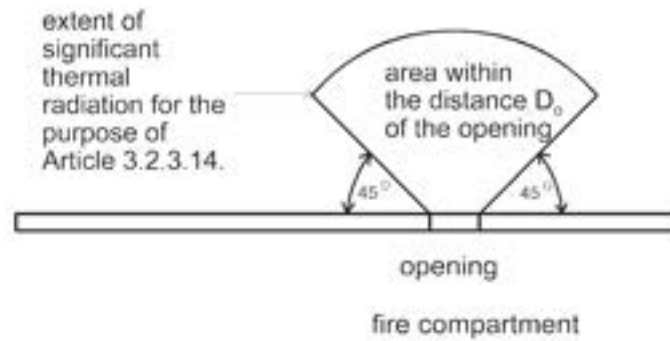


Figure A-3.2.3.14.D.
Thermal Radiation

Sentence 3.2.3.14.(2) requires the portion of an exterior wall (containing an unprotected opening) of any other fire compartment that falls within the shaded area of the Figure above to have a fire-resistance rating.

Figure A-3.2.3.14.E. illustrates the application of Sentence 3.2.3.14.(2) where the exterior walls of 2 fire compartments contain unprotected openings and the planes of the openings meet at 90°.

In order to apply Sentence 3.2.3.14.(2), the fire-resistance rating of each of the exterior walls exposed to significant thermal radiation at all angles of less than 135° within the distance, D_o , from the opening in the opposite wall must be investigated. In the example shown in Figure A-3.2.3.14.E., the effect of Opening A on the exterior wall of Fire Compartment “B” must be investigated as follows.

In this example, a portion of the exterior wall of Fire Compartment “B” happens to fall within the distance, D_o , and within the angle, θ less than 135°. However, only that part of the wall which is shown shaded is required to have a fire-resistance rating.

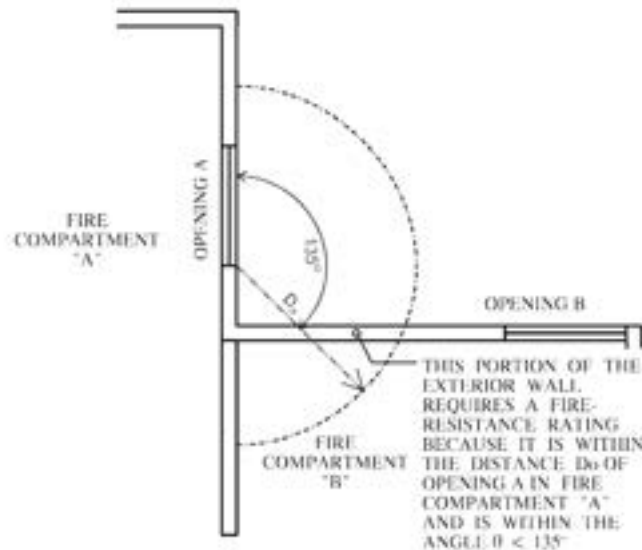


Figure A-3.2.3.14.E.
Thermal Radiation

A-3.2.4. Fire Alarm System.

The term “fire alarm system” used in this Subsection applies to fire alarm systems with or without voice communication capability.

A-3.2.4.4.(1) Single Stage Fire Alarm System.

This requirement, in combination with Article 3.2.4.23., is intended to allow for the provision of voice communication capability as an integral part of a single stage fire alarm system.

A-3.2.4.4.(2) Two Stage Fire Alarm System.

This requirement, in combination with Article 3.2.4.23., is intended to allow for the provision of voice communication capability as an integral part of a 2 stage fire alarm system.

A-3.2.4.4.(2)(c) Fire Alarm Alert Signal.

In a 2 stage fire alarm system described in Sentence 3.2.4.4.(2), the alert signal may be transmitted to audible signal devices in designated locations or to audible signal devices throughout the building. If actuated, the second stage alarm signal in a 2 stage fire alarm system may sound throughout all zones in the building. All manual station key switches would typically initiate the alarm signal.

Sentence 3.2.4.4.(2) also allows the implementation of a “zoned 2-stage” sequence of operation, whereby the alarm signal sounds in the zone of key switch actuation (and perhaps in the adjacent zones, which may be the storey above and the storey below) and the alert signal sounds throughout the rest of the building. This sequencing would be created automatically by the fire alarm control unit.

The key or special device referred to in Clause 3.2.4.4.(2)(c) should be immediately available to all persons on duty who have been given authority to sound an alarm signal.

A-3.2.4.7.(2) Access to Silencing Switches.

This requirement is intended to prevent unauthorized access to silencing switches. The satisfactory operation of a fire alarm system to alert the occupants of a building to an emergency is predicated on the assumption that the alarm signal will be silenced only after responsible staff have verified that no emergency exists.

a10.1 A-3.2.4.8.(4) Design and Installation of Fire Department Notification.

In some jurisdictions, the fire department may utilize, or have available, a municipal fire alarm system intended for receiving notification by means of a direct connection. If used, it is expected that these systems and installations conform to the requirements of Sentence (4) so as to achieve and provide a uniform and reliable level of service. It is also intended that a proprietary central station as well as a fire brigade used by a large corporation, university campus or similar site comply with Sentence (4).

CAN/ULC-S561, “Installation and Services for Fire Signal Receiving Centres and Systems” which is referenced in Sentence 3.2.4.8.(4), and CAN/ULCS524, “Installation of Fire Alarm Systems” which is referenced in Sentence 3.2.4.5.(1), go hand-in-hand: conformity to CAN/ULC-S561 entails conformity with the fire alarm system components required in that standard, which include the fire alarm transmitter (signal transmitting unit), the interconnections, and the communication path.

A-3.2.4.8.(5)(b) Emergency Telephone Number.

In many municipalities an emergency telephone number, for example 911, is used for all emergency services and it is preferable to post that number.

A-3.2.4.9.(2) Fire Alarm Zones.

Alarm initiating devices referred to in this Sentence include fire detectors, waterflow switches and manual pull stations. If a room or space in a building extends through more than one storey of the building, as in the case of multi-level dwelling units and machinery rooms, judgment must be exercised in the zoning and annunciation of the fire detectors in that room or space. In general, the lowest storey on which access is provided into the room or space should be indicated on the annunciator to

avoid unnecessary delays for the responding fire fighters. Consideration should also be given to the use of numbers or letters on the annunciator that correspond to those used in the building elevators.

A-3.2.4.9.(7) Indicator Devices.

It is permissible to install the fire alarm control unit in close proximity to the building entrance to meet the requirement for an annunciator. All signals required for the annunciator must be present at the control unit. In systems that include both control unit and annunciator, the signals must be routed to the annunciator through the control unit and the same functionality must be available at the control unit for operation and maintenance functions.

A-3.2.4.10.(3)(f) Supervision for Fire Pumps.

Specific electrical supervision for fire pumps is stated in NFPA 20, “Installation of Stationary Pumps for Fire Protection”, which is referenced in NFPA 13, “Installation of Sprinkler Systems”.

A-3.2.4.12.(1) Smoke Detector Location.

In the design and installation of the smoke detection system, consideration must be given to all features which could have a bearing on the location and sensitivity of the detectors, including ceiling height, sloped ceilings, diffusion from air conditioning and ventilating currents, obstructions, baffles, and other pertinent physical configurations that might interfere with the proper operation of the system.

A-3.2.4.12.(3) Visible Signals.

If staff located in each zone or compartment can see each sleeping room door, visible signals may be located above each door. If staff cannot see every door, it is intended that the visible signals be provided at the location where the staff are normally in attendance. The audible signal is intended to alert staff of the need to check the visible signals.

A-3.2.4.16.(1) Sprinklers in Lieu of Fire Detectors.

Recent editions of NFPA 13, “Installation of Sprinkler Systems” do not require a sprinkler to be installed in an elevator hoistway when certain conditions are met. The exemption to sprinkler the elevator shaft does not mean that fire detectors required by Sentence 3.2.4.11.(2) need not be provided.

A-3.2.4.18.(1) Manual Pull Station.

Only one manual pull station need be provided near a group of doors serving as a principal entrance or as a single exit facility.

A-3.2.4.20. Acoustic Measurement and Terminology.

The following notes on acoustic measurement and terminology are intended to assist in the application of the requirements for audibility of fire alarm system sounding devices.

The background or ambient measurement should be a spatial averaged A-weighted equivalent sound level measured for 60 s. This can be obtained using an integrating sound level meter with the integration time set to 60 s. During the measurement period the meter should be slowly moved about so as to sample the space uniformly but coming no closer than 0.5 m from any solid wall, floor or ceiling. Alternatively, measurements can be made at 3 or more positions throughout the space and an energy average calculated.

The measurement of the alarm level depends on the type of alarm signal. If the signal is a continuous signal from a bell or siren, the spatial averaged A-weighted equivalent sound level should be obtained. The integration time should be long enough to obtain a reasonable spatial average of the space, but not less than 10 s.

If the alarm has a temporal pattern, then the A-weighted sound level should be measured using the ‘fast’ time constant during the ‘on’ part of the cycle. In this situation it is not appropriate to use an integrating sound level meter. Since the duty cycle of the alarm is only 37.5% at best, that type of meter would give a reading that is 4 or more decibels lower than the level while the alarm is ‘on’. A number of measurements should be made about the space in question and the average value used to obtain a good spatial representation. Strictly speaking, the energy average of the measurements should be used; however,

the frequency spectrum associated with most alarms is of a type that should give little variation about the space. If the measured levels don't vary by more than 2 to 3 dB, then an arithmetic average rather than an energy average can be used.

Glossary of Acoustical Terms

Audible: A signal is usually considered to be clearly audible if the A-weighted sound level exceeds the level of ambient noise by 15 dB or more.

Awakening threshold: The level of sound that will awaken a sleeping subject 50% of the time.

A-weighted: A frequency weighting network which emphasizes the middle frequency components similar to the response of the human ear. The A-weighted sound level correlates well with subjective assessment of the disturbing effects of sounds. The quantity is expressed in dBA.

Masked threshold: The level of sound at which a signal is just audible in ambient noise.

Sound level: A sound pressure level obtained using a signal to which a standard frequency-weighting has been applied.

Sound pressure: A fluctuating pressure superimposed on the static pressure by the presence of sound. The unqualified term means the root-mean-square sound pressure. In air, the static pressure is barometric pressure.

Sound pressure level: Ten times the common logarithm of the ratio of the square of the sound pressure under consideration to the square of the standard reference pressure of 20 mPa. The quantity obtained is expressed in decibels.

A-3.2.4.20.(1) Alert and Alarm Signals.

Alert signals are part of a 2 stage fire alarm system. The intent of the first, alert, stage is to notify persons in authority of a potential threat to building occupants. In certain occupancies such as an emergency ward in a hospital, it may not be desirable for an alert signal to sound throughout the floor area. In such cases, the alert signal may be restricted to a continuously staffed location. Examples of continuously staffed locations include a nursing station in a hospital or a building security desk in an office tower, where staff on shift are available every day and at all times.

A-3.2.4.20.(2) Alarm Signal Temporal Pattern.

The temporal pattern of an alarm signal relates to the time during which the signal is produced and the intervals between the individual signal pulses. The international standard ISO 8201, "Acoustics - Audible Emergency Evacuation Signal", includes a pattern that is becoming widely used in different countries and it is appropriate for this pattern to be adopted in Canada. The temporal pattern can be produced on most signalling devices. Most existing alarm systems can be modified, and this pattern could be phased in when the systems require modification. The characteristic of the pattern is a 3-pulse phase followed by an off phase. The 3 pulses each consist of an on phase lasting for 0.5 ± 0.05 s followed by an off phase lasting for 0.5 ± 0.05 s sounded for 3 successive on periods and then followed by an off phase lasting for 1.5 ± 0.15 s. Figure A-3.2.4.20.(2).A. indicates the pattern that is intended.

Although the diagram shows a square wave form, the wave can have other shapes that produce a similar effect.

If single stroke bells are to be used, the temporal pattern can be produced by having the bell struck three times at a rate of one stroke per second followed by an interval of 2 s of silence. Figure A-3.2.4.20.(2).B. shows the pattern that results.

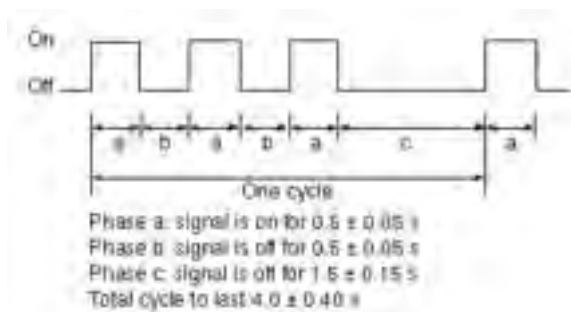


Figure A-3.2.4.20.(2).A.
Temporal Pattern for Fire Alarm Signal



Figure A-3.2.4.20.(2).B.
Temporal Pattern Imposed on a Single Stroke Bell or Chime

Note:

- (1) The on phase represents the time that the striker mechanism is actuated. The sound produced by the bell or chime will continue at a level that decreases until the striker mechanism is re-actuated.

A-3.2.4.20.(3) Audibility of Alarm Systems.

It is very difficult to specify exactly what types of sound patterns are considered to be “significantly different” from one another. The intent is to ensure that there is a noticeable or measurable difference between the alert signals and the alarm signals such that it reduces the possibility of confusion.

A-3.2.4.20.(5) Residential Sound Level.

In a building in which corridors or hallways serve more than one suite or dwelling unit, there will be situations in which an audible signal device cannot be placed in the corridor or hallway to alert persons sleeping in suites and dwelling units, because the sound level in the vicinity of the device would exceed that permitted by Sentence 3.2.4.20.(4).

In these situations it will be necessary to supplement the building fire alarm system with an audible signal device in the suite or dwelling unit. These devices could be piezoelectric devices similar to the sounding units in many smoke alarms, subject to the device emitting the appropriate temporal pattern required by Sentence 3.2.4.20.(2).

The sound pressure level required in this Sentence should be measured when the suite is unfurnished and unoccupied.

A-3.2.4.20.(9) Disconnect Device for Dwelling Units.

In order to minimize the annoyance caused by false and unwanted alarms, the disconnect is intended to permit a person to silence the local audible device within the dwelling unit. At that time the person would be aware of sounds from devices in common spaces and could plan appropriate action.

A-3.2.4.20.(10) Signal Circuits.

Clause 3.2.4.20.(10)(a) permits Class A wiring, or Class B wiring with signal circuit isolators located outside of the suites, to serve audible signal devices within residential suites. Clause 3.2.4.20.(10)(b) permits a separate signal circuit to serve each suite without the need for signal circuit isolators or Class A wiring. Open circuits and Class A and Class B wiring circuits are terms defined in CAN/ULC-S524, “Installation of Fire Alarm Systems.”

A-3.2.4.20.(13) Separate Signal Circuits.

Sentence 3.2.4.20.(10) in combination with Sentence 3.2.4.20.(11) require separate audible signal circuits for dwelling units. It allows the designer the option to wire the audible signal devices in a dwelling unit on an individual circuit that serves each suite only or to wire the audible signal devices in a common circuit that serves the dwelling units within the floor area and is separate from the circuit that serves the audible devices outside the dwelling unit. Compliance with either of the above two options would meet the intent of a separate circuit required in Sentence 3.2.4.20.(13).

A-3.2.4.21.(1) Visual Alarm Pattern.

CAN/ULC-S526, “Visible Signal Devices for Fire Alarm Systems Including Accessories”, published by Underwriters’ Laboratories of Canada, applies to visual signalling units. This document is referenced by the most recent standard for the installation of fire alarm systems and would automatically apply. Visual signalling devices with the same temporal pattern as required for audible devices are available from some sources and they should become available in Canada. Not all units that comply with the ULC standard will have sufficient power to adequately cover large areas; care will have to be taken to specify units with adequate power when large spaces are being designed.

A-3.2.4.21.(2) Visual Signal.

If staff located in each zone or compartment can see each sleeping room door, visual signals could be located above each door. If staff cannot see every door, it is intended that the visual signals be provided at the location where the staff are normally in attendance.

A-3.2.4.22.(5) Smoke Alarm Installation.

Ontario’s Electrical Safety Code permits a smoke alarm to be installed on most residential circuits that carry lighting outlets and receptacles. It is the intent of the Building Code that any other item on a circuit with a smoke alarm should be unlikely to be overloaded and trip the breaker with a resultant loss of power that is not sufficiently annoying for the breaker to be restored to the on position. It is considered that an interior bathroom light or a kitchen light fulfills this intent, but that circuits restricted to receptacles do not fulfill this intent.

A-3.2.4.22.(7) Smoke Detectors in Lieu of Smoke Alarms.

It is intended that the smoke detector in this application will function as per the requirements of a smoke alarm; specifically, it will be a localized alarm to the suite. The advantage of this type of installation is that the detector would be monitored by the fire alarm panel, which would provide notification to the supervisory personnel and be inspected as per CAN/ULC-S524, “Installation of Fire Alarm Systems.” It is not intended that smoke detectors used in lieu of smoke alarms will activate the fire alarm panel to send a signal to the fire department.

a3 A-3.2.4.22.(13) Smoke Alarms with a Visual Signalling Component.

Smoke alarms with a visual signaling component can alert people who are deaf, deafened or hard of hearing to the presence of smoke in the dwelling just as the alarm sound provides an alert to people with no or low vision or who are sighted. The visual signal provides an extra level of safety alerts to building residents.

a10.1 A-3.2.4.23.(1)(b) Voice Messages.

The concept of intelligibility expressed in Clause 3.2.4.23.(1)(b) is intended to mean that a person with average hearing and cognitive abilities is able to understand the messages that are transmitted into the space occupied by the person. There is no absolute measure to predetermine the effect of loudspeakers and it maybe necessary, once the building has been furnished and occupied, to increase to the number of loudspeakers to improve the quality of the messages.

The intelligibility of the message depends on the speech level, the background level, and the reverberation time of the space. ISO 7731, “Ergonomics - Danger Signals for Public and Work Areas - Auditory Danger Signals”, addresses audibility. The standard suggests that an A-weighted sound level at least 15 dBA above the ambient is required for audibility, but allows for more precise calculations using octave or ½ octave band frequencies to tailor the alarm signal for particular ambient noise conditions. Design of the alarm system is limited to ensuring that all areas receive an adequately loud alarm signal.

If a public address system is to be used to convey instructions during an emergency, then the requirements of the system are less straightforward. In general, however, a larger number of speakers operating at lower sound levels would be required.

Additional guidance on how to design and evaluate the intelligibility of a communication system can be found in the following documents

- IEC 60268-16, Sound System Equipment — Part 16: Objective Rating of Speech Intelligibility by Speech Transmission Index
- ISO 7240-19, Fire Detection and Alarm Systems — Part 19: Design, Installation, “Commissioning and Service of Sound Systems for Emergency Purposes”
- NEMA SB 50, “Emergency Communications Audio Intelligibility Applications Guide”
- Annex D of NFPA 72, “National Fire Alarm and Signaling Code”.

A-3.2.5.4.(1) Fire Department Access for Detention Buildings.

Buildings of Group B, Division 1 used for housing persons who are under restraint include security measures that would prevent normal access by local fire departments. These security measures include fencing around the building site, exterior walls without openings or openings which are either very small or fitted with bars, and doors that are equipped with security hardware that would prevent easy entry. These buildings would have firefighting equipment installed and the staff would be trained to handle any small incipient fires. It is expected that appropriate fire safety planning would be undertaken in conjunction with local fire departments in order that special emergencies could be handled in a cooperative manner.

A-3.2.5.6.(1) Fire Department Access Route.

The design and construction of fire department access routes involves the consideration of many variables, some of which are specified in the requirements in the Building Code. All these variables should be considered in relation to the type and size of fire department vehicles available in the municipality or area where the building will be constructed. It is appropriate, therefore, that the local fire department be consulted prior to the design and construction of access routes.

A-3.2.5.7. Water Supply.

This Article requires that an adequate water supply for firefighting is to be provided for every building. However, farm buildings of low human occupancy under the National Farm Building Code of Canada 1995 are exempted. The water supply requirements for interior fire suppression systems such as sprinkler systems and standpipe and hose systems are contained in other standards, for example, NFPA Standard 13, “Installation of Sprinkler Systems”, and NFPA Standard 14, “Installation of Standpipe and Hose Systems”. This Appendix note focuses only on water supplies that are considered essential to firefighting by fire department or other trained personnel using fire hoses.

Minimum requirements for water supply for firefighting are relevant mainly to building sites not serviced by municipal water supply systems. For building sites serviced by municipal water supply systems where the water supply duration is not a concern, water supply flow rates at minimum pressures would be the main focus of this Appendix note. However, where municipal water supply capacities are limited, it would be necessary for buildings to have on-site supplemental water supply.

An adequate water supply for firefighting should be an immediately available and accessible water supply with sufficient volume and/or flow to enable fire department personnel using fire hoses to control fire growth until the building is safely evacuated, prevent the fire from spreading to adjacent buildings, limit environmental impact of the fire, and provide a limited measure of property protection.

The sources of water supply for firefighting purposes may be natural or man-made. Natural sources may include ponds, lakes, rivers, streams, bays, creeks, springs, artesian wells, and irrigation canals. Man-made sources may include aboveground tanks, elevated gravity tanks, cisterns, swimming pools, wells, reservoirs, aqueducts, tankers, and hydrants served by a public or private water system. It is imperative that such sources of water be accessible to fire department equipment under all climate conditions.

The available water supply would allow arriving fire department personnel to use the water at their discretion when entering a burning building with hose lines. During the search and evacuation operation, hose streams may be needed for fire suppression to limit fire spread. The duration of the water supply should be sufficient to allow complete search and evacuation of the building. Once the search and rescue operations are complete, additional water may be required for exposure protection or fire suppression to limit property damage.

Fire departments serving remote or rural areas often have to respond to a fire with a transportable water supply of sufficient volume for approximately 5 to 10 minutes when using one or two 38 mm hose lines. This would provide minimal hose streams allowing immediate search and rescue operations in small buildings with simple layouts but limited fire suppression capabilities, especially if a fire is already well-established.

For larger more complex buildings, an on-site water supply for firefighting would be needed to provide an extended duration of hose stream use by the fire department to allow search and evacuation of the building, exposure protection and fire suppression. The volume of this on-site water supply would be dependent on the building size, construction, occupancy, exposure and environmental impact potential, and should be sufficient to allow at least 30 minutes of fire department hose stream use.

The recommendations of this Appendix note are predicated on prompt response by a well equipped fire department using modern firefighting techniques, and buildings being evacuated in accordance with established building fire safety plans and fire department pre-fire plans. For buildings constructed in areas where fire department response is not expected at all or in a reasonable time, sprinkler protection should be considered to ensure safe evacuation.

Elementary and secondary schools usually have a record of well established and practiced fire safety plans which would allow complete evacuations within 4 minutes. Because of this and the inherent high level of supervision in these buildings, a reduction of the water supply for firefighting may be considered. It is suggested that the level of reduction should be determined by the local enforcement authority based on the resources and response time of the fire department, and the size and complexity of the buildings.

When designing open, unheated reservoirs as sources of fire protection water, a 600 mm ice depth allowance should be included in the water volume calculations, except where local winter temperature conditions result in a greater ice depth (as typically found on local lakes or ponds). As well, make-up water supplies should be provided to maintain the design volumes, taking into account volume loss due to evaporation during drought periods.

1. Buildings not Requiring an On-Site Water Supply

- a6
- (a) A building would not require an on-site water supply for firefighting if the building satisfies the criteria set out in Item 1(b) or Item 1(c) provided that:
 - (i) the building is serviced by a municipal water supply system that satisfies Item 3(b), or
 - (ii) the fire department can respond with a transportable water supply of sufficient quantity to allow them to conduct an effective search and evacuation of the building, determined on the basis of other guidelines or standards (such as, NFPA 1142, “Standard on Water Supplies for Suburban and Rural Fire Fighting”).
 - (b) A building would not require an on-site water supply for firefighting where all of the following criteria are met:
 - (i) the building area is 200 m² or less,
 - (ii) the building height is 2 storeys or less,
 - (iii) the building does not contain a care or detention occupancy,
 - (iv) the building does not require a sprinkler system or a standpipe and hose system,
 - (v) the limiting distance from the property line is at least 13 m if the building contains a high hazard industrial occupancy, and
 - (vi) the building constitutes no significant environmental contamination potential due to fire.
 - (c) A building that exceeds 200 m² in building area or 2 storeys in building height and that contains a low hazard industrial occupancy may not require an on-site water supply for firefighting if the combustible loading in the building is insignificant (such as that found in cement plants, steel stock storage sheds, etc.), as determined by the chief building official.

2. Sprinklered Buildings

For sprinklered buildings, water supply additional to that required by the sprinkler systems should be provided for firefighting using fire hoses in accordance with the hose stream demands and water supply durations for different hazard classifications as specified in NFPA 13, “Installation of Sprinkler Systems”.

3. Buildings Requiring On-Site Water Supply

(a) Except for sprinklered buildings and as required by Items 3(c) and 3(e), buildings should have a supply of water available for firefighting purposes not less than the quantity derived from the following formula:

$$Q = K \cdot V \cdot S_{\text{tot}}$$

where

Q = minimum supply of water in litres

K = water supply coefficient from Table 1

V = total building volume in cubic metres

S_{tot} = total of spatial coefficient values from property line exposures on all sides as obtained from the formula:

$$S_{\text{tot}} = 1.0 + [S_{\text{side1}} + S_{\text{side2}} + S_{\text{side3}} + \dots \text{etc.}]$$

where

S_{side} values are established from Figure 1, as modified by Items 3(d) and 3(f), and

S_{tot} need not exceed 2.0.

(b) Water supply flow rates should not be less than that specified in Table 2. Where the water supply is from a municipal or industrial water supply system, the required flow rate should be available at a minimum pressure of 140 kPa.

(c) The water supply as required in Item 3(a) should not be less than that needed to provide the minimum flow rate specified in Table 2 for a minimum duration of 30 minutes.

(d) Where a masonry wall with a minimum fire-resistance rating of 2 h, and no unprotected openings is provided as an exterior wall, the spatial coefficient (S_{side}) for this side of the building may be considered equal to 0. This masonry wall should be provided with a minimum 150 mm parapet. Firewalls that divide a structure into two or more buildings may be given similar consideration when evaluating the exposure of the buildings to each other.

(e) In elementary or secondary schools, the water supply determined in accordance with Items 3(a) and 3(b) may be reduced. The level of reduction to be applied would be at the discretion of the local enforcement authority, and should not exceed 30 percent.

(f) The spatial coefficient S_{side} may be considered equal to 0 when the exposed building is on the same property and is less than 10 m² in building area.

4. Additions to Existing Buildings

(a) Except as permitted in Items 4(b) and 4(c), additions to existing buildings should be provided with a water supply for firefighting as required in Items 3(a) to 3(e). Although under Part 11, Renovation, the required water supply is to be based only on the building volume of the addition, it is recommended that the entire building volume of the expanded facility be used to ensure complete evacuation and safety of all the occupants.

(b) Buildings with new additions falling within any one of the following criteria would not require an additional water supply for firefighting where:

- (i) the expanded building complies with all the requirements of Item 1(a),
- (ii) the new addition does not exceed 100 m² in building area, or
- (iii) the new addition exceeds 100 m² but does not exceed 400 m² in building area, contains an assembly, business and personal services, mercantile or low hazard industrial occupancy, is of noncombustible construction, does not result in a significant increase in exposure to other existing buildings, has no combustible storage or process, and is separated from the existing building by a fire separation with a fire-resistance rating of at least 1 h.

(c) Where a firewall is provided between the new addition and the existing building, the water supply for firefighting may be determined in accordance with Items 1(a) and 3(a), using only the building volume of the new addition.

Table 1					
Water Supply Coefficient - K					
Type of Construction	Classification by Group or Division in Accordance with Table 3.1.2.1. of the Building Code				
	A-2 B-1 B-2 B-3 C D	A-4 F-3	A-1 A-3	E F-2	F-1
Building is of noncombustible construction with fire separations and fire-resistance ratings provided in accordance with Subsection 3.2.2., including loadbearing walls, columns and arches.	10	12	14	17	23
Building is of noncombustible construction or of heavy timber construction conforming to Article 3.1.4.6. Floor assemblies are fire separations but with no fire-resistance rating. Roof assemblies, mezzanines, loadbearing walls, columns and arches do not have a fire-resistance rating.	16	19	22	27	37
Building is of combustible construction with fire separations and fire-resistance ratings provided in accordance with Subsection 3.2.2., including loadbearing walls, columns and arches. Noncombustible construction may be used in lieu of fire-resistance rating where permitted in Subsection 3.2.2.	18	22	25	31	41
Building is of combustible construction. Floor assemblies are fire separations but with no fire-resistance rating. Roof assemblies, mezzanines, loadbearing walls, columns and arches do not have a fire-resistance rating.	23	28	32	39	53
Column 1	2	3	4	5	6

Table 2	
Part 3 Buildings under the Building Code	Required Minimum Water Supply Flow Rate, L/min
One-storey building with building area not exceeding 600 m ²	1 800
All other buildings	2 700 (if Q ≤ 108 000 L) ⁽¹⁾ 3 600 (if Q > 108 000 L and ≤ 135 000 L) ⁽¹⁾ 4 500 (if Q > 135 000 L and ≤ 162 000 L) ⁽¹⁾ 5 400 (if Q > 162 000 L and ≤ 190 000 L) ⁽¹⁾ 6 300 (if Q > 190 000 L and ≤ 270 000 L) ⁽¹⁾ 9 000 (if Q > 270 000 L) ⁽¹⁾

Notes to Table 2:

(1) Q = KVS_{tot} as referenced in Paragraph 3(a)

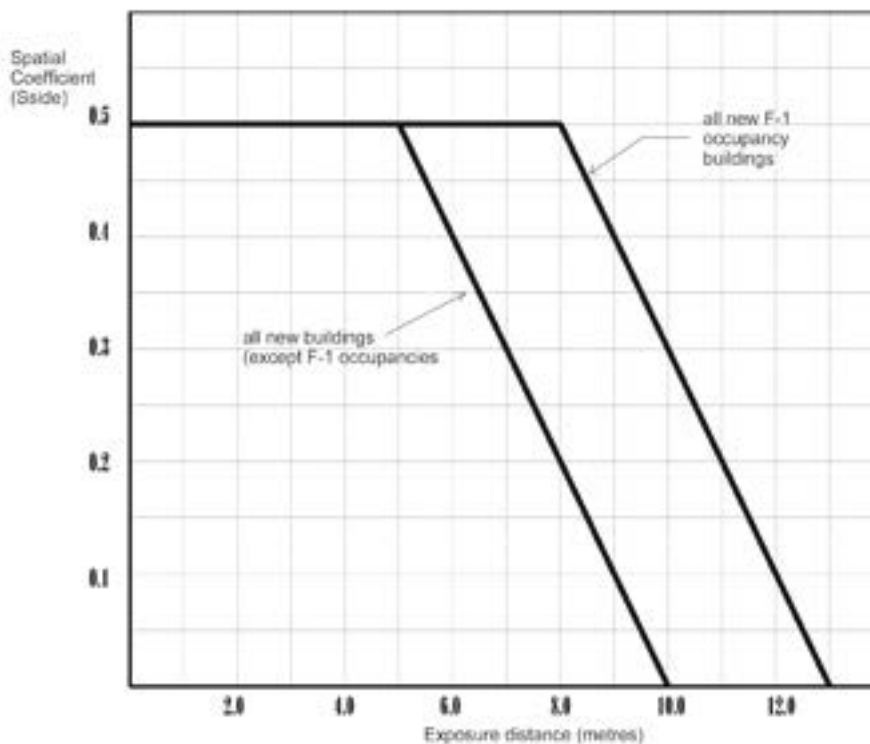


Figure 1
Spatial Coefficient vs Exposure Distance

Further clarification of intent and sample problems and solutions are contained in the “Fire Protection Water Supply Guideline for Part 3 in the Ontario Building Code”. This guideline may be obtained through the Office of the Fire Marshal’s web site at: “www.ofm.gov.on.ca”

A-3.2.5.13.(1) Sprinkler System Design.

In NFPA 13, “Installation of Sprinkler Systems”, reference is made to other NFPA standards which contain additional sprinkler design criteria. These criteria apply to industrial occupancies with high fire loads, including warehouses with high piled storage, and industrial occupancies intended for the use, manufacture or storage of highly flammable materials. Therefore, while only NFPA 13 is called up directly by Sentence 3.2.5.13.(1), the additional criteria in the other NFPA standards are included automatically.

In some NFPA standards, certain aspects of sprinkler protection are dependent on the fire-resistance rating of the vertical structural members. In these cases, the sprinkler system design options can be affected by the fire-resistance rating of these elements. For example, in buildings used for the storage of rubber tires, sprinklers directed at the sides of a column are required if the column does not have the required fire-resistance rating.

Other NFPA standards may require that certain occupancies be sprinklered in conformance with NFPA 13, as in the case of some garages. These requirements do not supersede the requirements in the Building Code. An occupancy is required to be sprinklered only when this is specified in the Building Code, but when it is so required, it must be sprinklered in conformance with NFPA 13 and its referenced standards.

- a10.1** Additionally, while Part 4 contains seismic force provisions that apply to the design of sprinklers, NFPA 13 contains other structural requirements for sprinklers that are also required to be met.

a10.1 A-3.2.5.13.(2) Sprinklering of Residential Buildings Above a Storage Garage Considered as a Separate Building.

For the purpose of determining whether NFPA 13R, “Installation of Sprinkler Systems in Residential Occupancies up to and including Four Stories in Height”, applies to a residential building constructed over a storage garage, it is not intended that a storage garage constructed as a separate building in accordance with Article 3.2.1.2. be considered as a storey when determining the building height of the residential building. Similarly, this would not preclude the use of NFPA 13D, “Installation of Sprinkler Systems in One- and Two-Family Dwellings and Manufactured Homes”, for any one- or two-family home constructed above such a storage garage.

A-3.2.5.13.(6) Sprinklering of Roof Assembly.

Sprinkler protection for roof assemblies in lieu of fire resistance is based on the assumption that the sprinklers will protect the roof assembly from the effects of fire in spaces below the roof. If a ceiling membrane is provided, the sprinklers would have to be located below the membrane in order to react quickly to the fire. In certain instances, however, sprinklers may be required within the concealed spaces as well as below the membrane. NFPA 13, “Installation of Sprinkler Systems”, requires sprinklers in certain concealed spaces.

According to NFPA 13 and 13R, rooms and closets within a dwelling unit in a sprinklered building, including those in the storey immediately below the roof assembly do not require sprinklers. However, the Building Code requires sprinkler protection within all rooms and closets immediately below the roof so as to control any fire that might start in that space and thereby limit the probability of the fire spreading into the roof assembly.

Moreover, NFPA 13D, “Installation of Sprinkler Systems in One- and Two-Family Dwellings and Manufactured Homes,” also allows the omission of sprinklers in such rooms and closets under certain circumstances, provided the building is sprinklered in conformance with this standard. In this case, the Building Code concurs with the provisions of the NFPA 13D standard.

a10.1 A-3.2.5.13.(7) Balconies and Decks.

The intent of this provision is to suppress or control a fire originating from a balcony or deck which could spread to the balcony above, roof assembly or other parts of the building. It is not intended to apply to a roof top deck or uppermost balcony where there are no parts of the building above.

e3 A-3.2.5.13.(8) Sprinkler Rating.

The requirements of this Sentence can be met by using sprinklers with a rating of 79°C to 107°C.

A-3.2.5.14.(1) Hazard Classification for Sprinkler Selection.

The reference to light hazard occupancies is based on the descriptions of these occupancies given in NFPA 13, “Installation of Sprinkler Systems” and is intended only for use in the design of sprinkler systems. These descriptions should not be confused with the occupancy classifications in the Building Code.

In NFPA 13 a light hazard occupancy is one in which the quantity or combustibility of contents is low and fires with relatively low rates of heat release are expected. Typical buildings or parts of buildings include: churches; clubs; eaves and overhangs, if of combustible construction with no combustibles beneath; educational buildings; hospitals; institutional buildings; libraries, except very large stack rooms; museums; long term care or convalescent homes; offices, including data processing rooms; residential buildings; restaurant seating areas; theatres and auditoria, excluding stages and proscenias; and unused attics.

Although NFPA 13R, “Installation of Sprinkler Systems in Residential Occupancies up to and Including Four Stories in Height”, and NFPA 13D, “Installation of Sprinkler Systems in One- and Two-Family Dwellings and Mobile Homes”, as referenced by NFPA 13, are concerned with specific types of residential occupancy, namely apartment buildings up to four storeys, one and two family dwellings, and mobile homes, for the purpose of acceptance of combustible sprinkler piping these occupancies are considered to be included in the category of residential buildings under light hazard occupancies.

A-3.2.5.19.(1) Fire Pumps.

In order to ensure an adequate water supply, it may be necessary to install a fire pump for a building that has either a standpipe system or an automatic sprinkler system installed. Reference to NFPA 20, “Installation of Stationary Pumps for Fire Protection”, provides the necessary guidance to designers.

A-3.2.6. High Buildings.

It is assumed that buildings regulated by Subsection 3.2.6. will be in an area served by a fire department capable of an early response and that all firefighting and rescue situations will be under the direct control of the officer-in-charge of the fire department responding to the emergency.

Measures that relate to limiting or controlling the movement of smoke caused by a building fire are described in the Supplementary Standard SB-4. Adoption of one of these measures is considered to be an acceptable means of complying with the requirements of this Subsection.

A-3.2.6.4.(6)(a) Elevator Recall.

Automatic emergency recall actuation that is dependent on the operation of 2 smoke detectors in the elevator lobby meets the intent of this requirement. Such an arrangement may reduce the frequency of nuisance recalls.

A-3.2.7.4.(1) Emergency Power Reliability.

In some areas power outages are frequent and may be of long duration. These local conditions should be taken into account in determining the type of system for supplying emergency power for lighting. This should be studied at the planning stage of a building project in conjunction with the local fire safety and building officials.

A-3.2.7.6.(1) Emergency Power for Hospitals.

CSA-Z32, “Electrical Safety and Essential Electrical Systems in Health Care Facilities”, contains requirements for three classes of health care facilities - Class A, Class B and Class C. The intent of Article 3.2.7.6. is to apply specific requirements for emergency equipment for Class A facilities, which are designated as hospitals by the enforcement authority and where patients are accommodated on the basis of medical need and are provided with continuing medical care and supporting diagnostic and therapeutic services.

A-3.2.7.8.(3) Emergency Power Duration.

The times indicated in this Sentence are the durations for which emergency power must be available for a building under fire emergency conditions. Additional fuel for generators or additional battery capacity is required to handle normal testing of the equipment. If the operation of emergency generators or batteries is intended for other than fire emergency conditions, such as power failures, fuel supplies or battery capacity must be increased to compensate for that use.

A-3.2.7.9.(1) Emergency Power Reliability.

In some areas power outages are frequent and may be of long duration. These local conditions should be taken into account in determining the type of system for supplying emergency power for building services. This should be studied at the planning stage of a building project in conjunction with the local fire safety and building officials.

a10.1 A-3.2.7.10.(2)(a) and (3)(a) Protection of Electrical Conductors.

It is important to understand that electrical conductors are part of a system that includes—among other components—raceways, conduits, splices, couplings, vertical supports, grounds and pulling lubricants. When selecting electrical conductors to provide a circuit integrity rating, it is therefore important to understand how they will be installed and to know if the fire performance of the system as a whole was tested.

A-3.2.7.10.(5)(b) Electrical Conductors in the Same Room.

If the distribution panel and the equipment it serves are within the same room, only the electrical conductors leading up to the distribution panel need to be protected. It is assumed that the distribution panel and the equipment it serves are within sufficient proximity to each other such that a fire in the same area of origin would affect both.

A-3.2.7.10.(7) Fire Alarm Branch Circuits.

In order to ensure continuous operation of the fire alarm and voice communication system in a high-rise building for a sufficient duration of time to control and direct the evacuation of building occupants, a level of protection is required by Sentence 3.2.7.10.(2) for those electrical conductors interconnecting the major elements of the fire alarm system. Sentence 3.2.7.10.(7) permits the protection of electrical conductors to be waived for portions connecting a transponder or fault isolation device to the fire alarm input devices (fire detectors, manual stations, etc.) or a voice communication transponder to a fire alarm audible signalling device, provided all circuits or portions of the circuits are contained within the same storey.

A-3.2.8.2.(3) Special Protection of Opening.

In manufacturing operations involving the use of conveyor systems to transport material through fire separations, it may not be possible to use standard closure devices. NFPA 80, “Fire Doors and Other Opening Protectives”, includes appendix information concerning protection of openings through vertical fire separations. NFPA 13, “Installation of Sprinkler Systems”, includes methods of protecting openings through floor assemblies, however, it is assumed by that standard that the remainder of the building would be sprinklered. Combinations of methods may be required to ensure that the level of safety inherent in the requirements of the Code is maintained.

A-3.2.8.2.(6) Waiver of Occupancy Separation Continuity.

The typical application of this Sentence is to buildings with a mixture of occupancies that are randomly located throughout the building. Examples include shopping centres, podiums of large commercial and business complexes, and recreational buildings that are combined with mercantile and business operations. A shopping mall with two interconnected storeys is an example that is frequently encountered in many jurisdictions. The permission to breach the floor assembly between the storeys does not override requirements for separation of specific suites or occupancies. For instance, although storage garages are Group F, Division 3 occupancies, the requirement in Article 3.3.5.6. for the storage garage to be separated from other occupancies by a fire separation with at least a 1.5 h fire-resistance rating must be observed. In a similar manner, a theatre or cinema (Group A, Division 1 occupancy) must be separated from other occupancies in accordance with Sentence 3.3.2.2.(1) and seats in an arena type building (Group A, Division 3) must be separated from space below in accordance with Sentence 3.3.2.2.(3).

A-3.2.8.3.(2)(b) Area of Ellipse.

The area of an ellipse, whose semi-axes are a and b , is equal to “ $\pi \cdot ab$ ”, where $\pi = 3.14$.

A-3.2.8.4.(6) Area of Safety.

The objective of this Sentence is to provide an area of temporary safety in the exit stair shafts for those occupants of the interconnected floor space. This requirement is considered to be met where 0.3 m^2 per person is provided in the stair shaft between the floor level served and floor level immediately beneath it.

A-3.2.8.8.(1)(b) Smoke Detector Location.

In the design and installation of the smoke detection system, it is essential that consideration be given to all features which could have a bearing on the location and sensitivity of the detectors, including such pertinent physical configurations as ceiling height, sloped ceilings, diffusion from air conditioning and ventilating currents and the location of any obstructions or baffles that might interfere with the proper operation of the system.

A-3.2.9.2.(4)(c) Fire Department Pumping Equipment.

Availability of appropriate pumping equipment from the local fire department or, in the case of industrial plants or complexes, from their fire brigade, is considered sufficient to meet the intent of this requirement.

a10.1 A-3.2.10.1.(1) Testing of Fire Protection and Life Safety Systems.

Building owners should verify that fire protection and life safety systems and their components (i.e. fire alarm systems, sprinklers, standpipes, smoke control, ventilation, pressurization, door hold-open devices, elevator recalls, smoke and fire shutters and dampers, emergency power, emergency lighting, fire pumps, generators, etc.) , including their interconnections with other building systems, are functioning according to the intent of their design . CAN/ULC-S1001, “Integrated Systems Testing of Fire Protection and Life Safety Systems” provides the methodology for verifying and documenting that

interconnections between building systems satisfy the intent of their design and that systems function as intended by the Code.

Clause 6.1.5. of CAN/ULC-S1001 allows the Integrated Testing Coordinator to accept documented evidence of any tests that have been performed on a system as part of its acceptance testing for the purpose of demonstrating compliance with the integrated testing requirements of that standard, so as to avoid duplication of work.

A-3.3. Safety Within Floor Area.

Section 3.3. regulates safety within floor areas including rooms or other spaces within a building, with the exception of service rooms and service spaces that are regulated by Section 3.6. The requirements are grouped according to the occupancy of the floor area, room or space. The occupancy of these floor areas and other spaces is not necessarily the major occupancy for which the building is classified.

Life safety for the occupants of any floor area depends in the first instance on the use or occupancy of that floor area. The risks to the occupants occur in the early stages of a fire. These special life risks differ from one occupancy to another and, consequently, must be regulated differently. Section 3.3. regulates risks within floor areas, and these requirements apply regardless of the major occupancy of the building that contains them. For example, an assembly room must comply with the requirements for assembly occupancy whether it is contained in an office building, hospital, hotel, theatre, industrial building or other major occupancy.

a10.1 A-3.3.1.2.(1) Hazardous Substances.

The term “hazardous substances” refers to dangerous goods that are regulated by TC SOR/2008-34, “Transportation of Dangerous Goods Regulations (TDGR)” or that are classified as “controlled products” under the “Workplace Hazardous Materials Information System (WHMIS)” established to meet the requirements of HC SOR/2015-17 “Hazardous Products Regulations”. It also refers to materials and products that are not regulated by the TDGR or WHMIS, but that pose a fire or explosion hazard due to their own properties or because of the manner in which they are stored, handled or used. These include combustible products, rubber tires, combustible fibres, combustible dusts, products producing flammable vapours or gases, etc.

A-3.3.1.2.(2) Cooking Equipment Ventilation.

Cooking equipment manufactured for use in dwelling units and other residential suites is often installed in buildings used for assembly and care or detention purposes. It is not obvious from the Building Code requirements or those of NFPA 96, “Ventilation Control and Fire Protection of Commercial Cooking Operations”, whether a ventilation and grease removal system is required in all assembly, care or detention uses. If the equipment is to be used in a manner that will produce grease-laden vapours that are substantially more than would be produced in a normal household environment, then it would be appropriate to apply the requirements of NFPA 96. If the equipment is used primarily for reheating food prepared elsewhere or is used occasionally for demonstration or educational purposes, there would be no expectation of applying the requirements of NFPA 96. In all cases the circumstances should be reviewed with the enforcement authority.

A-3.3.1.4.(1) Occupancy in Corridor.

Since the Building Code regulates new construction, alterations and changes of occupancy, kiosks in public corridors are required to be constructed on the same basis as the remainder of the building. This means that the construction of kiosks and similar structures must take into consideration all the requirements which apply to the remainder of the building, including structural fire protection, construction type, finish materials, egress widths and sprinkler installations.

A-3.3.1.7.(1) Temporary Refuge for Persons with Disabilities.

These measures are intended to provide temporary refuge for persons with disabilities. It is acknowledged, however, that the measures cannot provide absolute safety for all occupants in the fire area. It may, therefore, be necessary to develop special arrangements in the fire safety plan to evacuate persons with disabilities from these areas.

The protected elevator referred to in Clause 3.3.1.7.(1)(a) is intended to be used by firefighters as a means for evacuating persons with disabilities. It is not intended that this elevator be used by persons with disabilities as a means of egress without the assistance of firefighters.

If an estimate is to be made of the number of persons with disabilities in a floor area who can be accommodated in each zone in Clause 3.3.1.7.(1)(b), this estimate may be based on Table 3.8.2.1., which is used to determine the minimum number of spaces to be provided for wheelchair occupants in fixed seating areas. If more precise information is available, it should be used for sizing the zones.

a10.1 A-3.3.1.7.(1)(b) Zones.

The floor area on either side of a horizontal exit conforming to Article 3.4.6.10. may be considered as a zone in applying the requirements of Article 3.3.1.7.

A-3.3.1.9.(4) Obstruction in Corridor.

The sweep of a cane used by a person with vision loss normally detects obstructions that are within 680 mm of the floor. Any obstruction above this height would not normally be detected and can, therefore, create a hazard if it projects more than 100 mm into the path of travel.

A-3.3.1.11.(3) Movable Partitions.

Should an emergency situation arise outside of normal working hours but when occupants are still in the space, they could be left without a clear way out. This could occur during inventory or after closing time when all occupants have not yet left, but staff close the door to prevent other persons from entering. In many small tenant areas, the movable partitions (store fronts) provide the only way out. There should always be a second way out or a swinging door within or adjacent to the sliding partitions.

A-3.3.1.12.(4) Door Hardware.

The permission to have additional door releasing devices is intended to allow the use of a security chain, night latch or dead bolt to supplement the normal door latching device. These are permitted for dwelling units and locations where guests in a hotel require additional security. The height of these items is also governed by the maximum height stipulated in Sentence 3.3.1.12.(5) to ensure that they can be operated by persons with physical disabilities. This additional hardware should not require appreciable dexterity by the user and the general requirements on the ability to operate the device without the use of keys, special tools or specialized knowledge still apply.

A-3.3.1.12.(6) Controlled Egress Doors.

It is intended that Sentence 3.3.1.12.(6) apply to doors used at the perimeter of a contained use area or an impeded egress zone. If the contained use area consists of a single room, the requirements would apply to that room. In the case of individual cells within a contained use area, exterior keyed locks could be used on the cell doors consistent with the fire safety plan and continuous supervision by staff who can release the doors in an emergency.

A-3.3.1.22.(1) Obstructions in Means of Egress.

Obstructions including posts, counters or turnstiles should not be located in a manner that would restrict the width of a normal means of egress from a floor area or part of a floor area unless an alternative means of egress is provided adjacent to and plainly visible from the restricted means of egress.

A-3.3.2.3.(2) Tablet Arms.

Although it is intended that the motion to raise the tablet arm be essentially a single fluid motion, it is acceptable that the motion be a compound motion of raising the tablet arm and including an articulation to allow the tablet to fall back alongside the arm rest.

a10.2 A-3.3.2.8A. Installation Configurations of Handrails in Aisles with Steps.
 Figure A-3.3.2.8A. illustrates possible installation configurations of handrails serving aisles with steps.

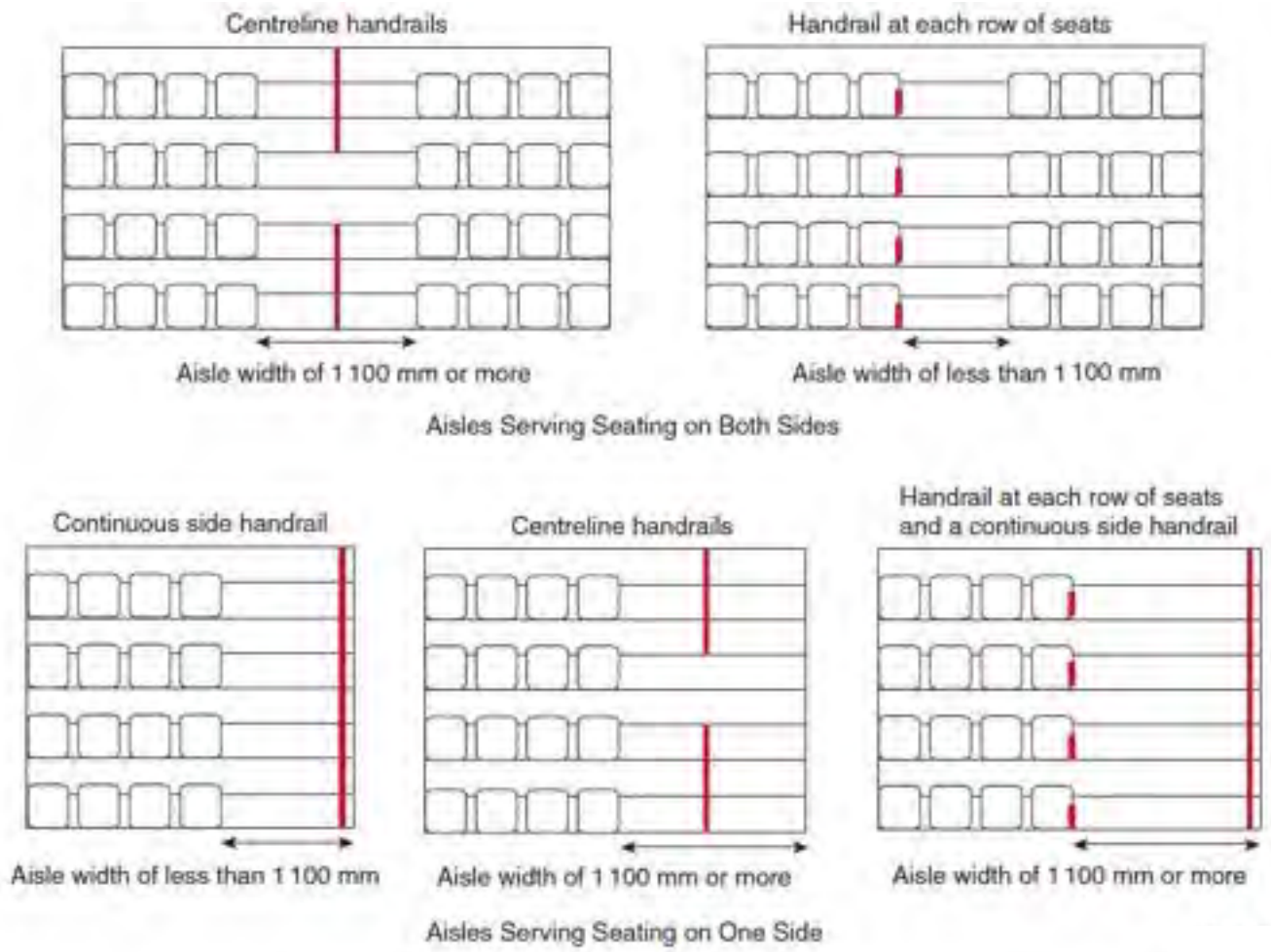


Figure A-3.3.2.8A.
 Installation Configurations of Handrails in Aisles with Steps

A-3.3.3.1.(1) Safety in a Care or Detention Occupancy.

Fire safety for patients and residents in sleeping room areas in care or detention occupancies is predicated on the ability of staff to carry out at all times essential life safety functions in accordance with the fire safety plan.

A-3.3.3.4.(1) Doorway Width.

The 1 050 mm minimum clear width of doorways accounts for door stops and, thus, is intended to allow for the use of 1 100 mm doors.

This Page
Intentionally Left Blank

A-3.3.3.5.(1) Hospitals and Long-Term Care Homes.

The basis for the requirements in this Article is that staff will be in attendance at all times on the same storey, either in each fire compartment or in a fire compartment immediately adjacent.

A long-term care home is intended to include skilled nursing facilities, intermediate care facilities and some homes for the aged. Occupants of long-term care homes are assumed to be, for the most part, non-ambulatory. The use of physical restraints and tranquilizing drugs which may render occupants immobile are also factors which should be considered.

Although the age of patients by itself is not sufficient justification for a floor area to be included in a long-term care home occupancy, it should be recognized that many homes for the aged are in fact long-term care homes. The factor that determines whether or not a home for the aged is a long-term care home and, therefore, a care and treatment occupancy, is whether or not continuous nursing care is required for the occupants. Where continuous nursing care and treatment is not provided for the occupants, a home for the aged may be classified as either a care occupancy or a residential occupancy. If no care is provided to the residents, a home for the aged would normally be classified as a residential occupancy.

A-3.3.3.5.(10) Intercommunicating Rooms.

Rooms that are interconnected can include more than one sleeping room, together with ensuite toilet rooms, shower rooms, and storage closets used for the storage of personal items of the persons occupying the sleeping rooms. It is not intended that storage rooms for other purposes be included within the group of interconnected rooms.

A-3.3.4.4.(1) Landing in Egress Stairway.

A landing level used in an egress stairway from a dwelling unit is not considered to be a storey of that dwelling unit if the landing is used only for pedestrian travel purposes.

A-3.3.4.5.(1) Automatic Locking Prohibited.

Doors that must be manually reset to lock them when they are opened from the inside meet the intent of this requirement.

a2.1 A-3.3.4.9.(1) Stud Wall Reinforcement.

If the bathroom layout does not provide a wall beside the water closet, the reinforcing for future installation of a grab bar would only be required in the wall behind the water closet.

A-3.3.5.4. Electrical Wiring and Appliances.

Sources of ignition, such as electrical wiring and appliances, can set off an explosion if exposed to gases or vapours such as those that can be released in a repair or storage garage. The Ontario Electrical Safety Code contains provisions requiring either shielded wiring installations adjacent to certain garages or an air-tight curb separating the garage from adjacent spaces.

A-3.3.6.1.(1) Design of Hazardous Areas.

Subsection 3.3.6. applies to the storage of products, whether raw or waste materials, goods in process, or finished goods.

This Subsection does not deal with products or materials that are directly supplied to appliances, equipment or apparatus through piping, hose, etc. For example, gas cylinders that are mounted on propane barbeques are not covered by Subsection 3.3.6. since they are considered to be “in use” as opposed to “in storage”.

The design requirements contained in Subsection 3.3.6. reflect some, but not all design requirements contained in Division B of the Fire Code as it relates to the design of hazardous areas. Designers are advised to refer to the Fire Code for any other design requirements that may apply to their circumstances.

a10.1 A-3.3.6.2.(2) Storage of Reactive Materials.

Reactive materials include various classes of unstable or reactive dangerous goods, such as flammable solids, pyrophoric materials, oxidizers, corrosives, water-reactive substances and organic peroxides.

In general, it is unsafe to store highly reactive oxidizers close to liquids with low flash points, combustible products or chemically incompatible products. Quantities of oxidizers or other dangerously reactive materials should therefore be limited and the storage area should be constructed of noncombustible materials, should be kept cool and ventilated, and should not impede egress.

In some cases, depending on the quantity and nature of the oxidizing agent, normal fire protection measures (e.g. sprinklers, fire hose and extinguishers) are ineffective due to the self-yielding of oxygen by the oxidizing agent.

When containers of highly reactive oxidizers become damaged or are exposed to excessive heat, humidity or contamination (e.g. sawdust, petroleum products, or other chemicals), a very violent fire or explosion can result.

The following oxidizing substances, among others, are known to supply oxygen: organic and inorganic peroxides; pool chemicals (e.g. calcium hypochlorite, sodium dichloroisocyanurate); oxides; permanganates; perhenates; chlorates; perchlorates; persulfates; organic and inorganic nitrates; bromates; iodates; periodates; perselenates; chromates, dichromates; ozone; perborates.

When containers of dangerously reactive materials become damaged or are exposed to water or humidity, a flammable gas (such as hydrogen, ammonia or methane) or a toxic gas (such as hydrogen chloride, hydrogen bromide or phosphine) can be released.

The following dangerously reactive materials, among others, are known to release a flammable gas in reaction to contact with water or humidity: alkali metals (e.g. sodium, potassium, cesium); reactive metals (e.g. zinc, aluminum, magnesium); metallic hydride (e.g. sodium borohydride, germanium tetrahydride, calcium hydride).

The following dangerously reactive materials, among others, are known to release a toxic gas in reaction to contact with water or humidity: organic and inorganic chloride (e.g. phosphorus trichloride, phosphorus oxide trichloride, acetyl chloride); organic and inorganic bromide (e.g. phosphorus tribromide, aluminum tribromide, acetyl bromide).

A-3.3.6.4.(2) Explosion Venting in Hazardous Locations.

When a flammable mixture of air and vapour/gas/dust is ignited and causes an explosion, the exothermic reaction results in the rapid expansion of heated gases and the corresponding pressure waves travel through the mixture at sonic or supersonic velocities. The pressures developed by an explosion very rapidly reach levels that most building structures and equipment cannot withstand unless specifically designed to do so. Explosion venting consists of devices designed to open at a predetermined pressure to relieve internal pressure build-up inside a room or enclosure, hence limiting the structural and mechanical damage.

The major parameters to be considered in designing an explosion venting system for a building are:

- the physical and chemical properties of the flammable air mixture, such as the particle size or the droplet diameter, the moisture content, the minimum ignition temperature and the explosive concentration, the burning velocity or explosion classification, the maximum explosion pressure and the rate of pressure rise,
- the concentration and dispersion of the flammable mixture in the room,
- the turbulence and physical obstructions in the room,
- the size and shape of the room, the type of construction and its ability to withstand internal pressures, and
- the type, size and location of relief panels, which should be designed to reduce the possibility of injury to people in the immediate vicinity of the panels.

A-3.3.6.5.(1) Measurement of Tire Storage Volume.

The volume of tires in a storage area can be determined by measuring to the nearest 0.1 m the length, width, and height of the piles or racks intended to contain the tires. In racks, the top shelf is assumed to be loaded to a maximum possible height, while observing required clearances between structural elements and sprinklers.

A-3.3.6.6.(1) Products Stored with Ammonium Nitrate.

Copper and its alloys should not be used where they can come into contact with ammonium nitrate. The presence of copper represents the single greatest hazard with respect to the accidental detonation of ammonium nitrate during a fire.

Steel and wood can be protected with special coatings such as sodium silicate, epoxy, or polyvinyl chloride.

Asphalt and similar hydrocarbon-based roof coverings should not be used. Stored ammonium nitrate may become sensitized during a fire if such roof coverings melt and leak into the interior of the building, causing burning droplets to fall on the stored product.

A-3.4.1.6.(2) Sleeping Area.

Areas serving patients' or residents' sleeping rooms include sleeping areas and areas where patients or residents are taken for treatment.

A-3.4.2.3.(1) Least Distance Between Exits.

The least distance measurement does not apply to each combination of exits on a multi-exit storey. It only applies to at least 2 of the required exits from that storey.

A-3.4.3.2.(7) Door Width.

The clear width values of exit doorways in Clauses 3.4.3.2.(7)(f) and (g) account for door stops and are intended to allow for the use of 1 100 mm doors in Clause 3.4.3.2.(7)(f) and 810 mm doors in Clause 3.4.3.2.(7)(g).

A-3.4.3.4. and 3.4.3.5. Clear Height and Width of Exits.

Clear height is intended to be measured from a line tangent to the nosings extended to the underside of the lowest element above the walking surface, over the clear width of the exit (see Figure A-3.4.3.4.) Examples of low elements above the walking surface include light fixtures, sprinkler heads and pipes.

Clear width is intended to be measured from a line tangent to the horizontal protrusions such as handrails.

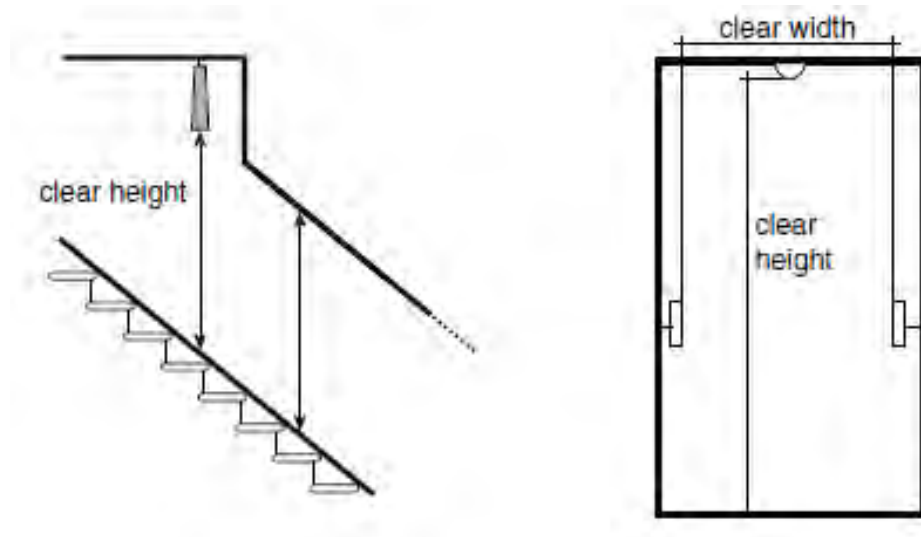


Figure A-3.4.3.4.
Measuring Clear Height

A-3.4.4.2.(2)(e) Requirements for Lobby.

If an exit is permitted to lead through a lobby, the lobby must provide a level of protection approaching that of the exit. As well as meeting the width and height requirements for exits, the lobby must be separated from the remainder of the building by a fire separation having a fire-resistance rating at least equal to that required for the exit, unless one of the exceptions in this Clause is applied.

A-3.4.5.1.(2)(c) Graphic Symbols for Exit Signs.

ISO 7010, “Graphic symbols - Safety colours and safety signs - Safety signs used in workplaces and public areas”, identifies the recognized symbols for use at required exits. Examples are provided in Figures 3.4.5.1.(2)(c)(i) and 3.4.5.1.(2)(c)(iii).



Figure A- 3.4.5.1.(2)(c)(i)
Emergency Exit Left Symbol (E001) from ISO 7010



Figure A- 3.4.5.1.(2)(c)(iii)
Emergency Exit Directional Arrow (E005) from ISO 7010

A-3.4.5.1.(5) Photoluminescent Exit Signs.

An external lighting source is required to properly charge photoluminescent signs. These types of signs must be lit in conformance with the charging requirements stated in CAN/ULC-S572, “Photoluminescent and Self-Luminous Exit Signs and Path Marking Systems”.

A-3.4.5.2.(2) Stairwell Signs.

Past experience indicates that some persons attempt to exit at the roof level of a building in the event of an emergency. Rescue from the roof of a building more than six storeys high is rarely possible from the exterior of a building. In order to avoid instances of persons getting trapped by smoke at the top of a stairwell that has no access to a roof, signs are required within the stairwell (at least one sign immediately above the highest normally occupied floor level) to indicate that the stairwell does not provide an exit at the roof level. The sign should consist of a graphic and text to indicate that there is no exit to the roof.

A-3.4.6. Application to Means of Egress.

The requirements in Subsection 3.4.6. apply to interior and exterior exits, as well as to ramps, stairways and passageways used by the public as access to exit. The treads, risers, landings, handrails and guards for the latter access to exit facilities must thus be provided in conformance with the appropriate requirements for exit facilities.

a3 A-3.4.6.1.(2) Surface Finish of Ramps and Stairs.

A tactile attention indicator strip signals a warning to people with no or low vision that they are approaching a change in level. The strip is set back from the leading edge of the stair to provide sufficient warning of the change in level in advance.

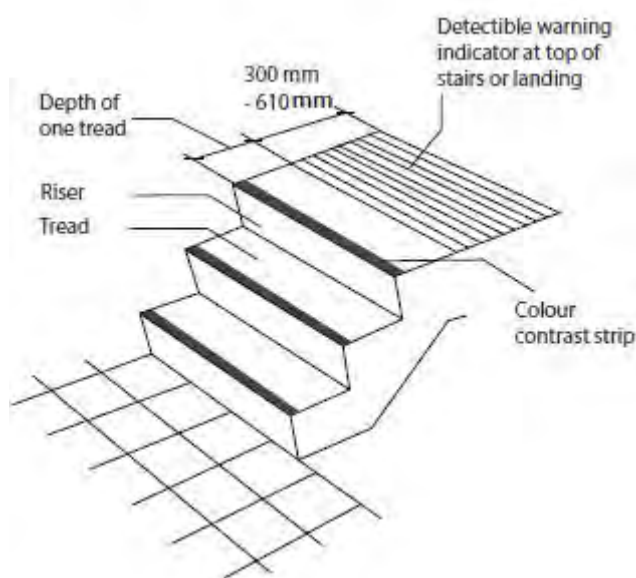


Figure A-3.4.6.1.(2)
Tactile Indicator at Stairs and Ramps

a10.2 A-3.4.6.4. Dimensions of Landings.

A landing is a floor area provided at the top or bottom of a flight of stairs or a ramp, or a platform built as part of a stairway or ramp. Landings provide a safe surface for users to rest upon, allow design flexibility, and facilitate a change in direction.

Figure A-3.4.6.4. illustrates how to measure the length of a landing for various landing configurations turning less than 90 degrees, including straight landings.

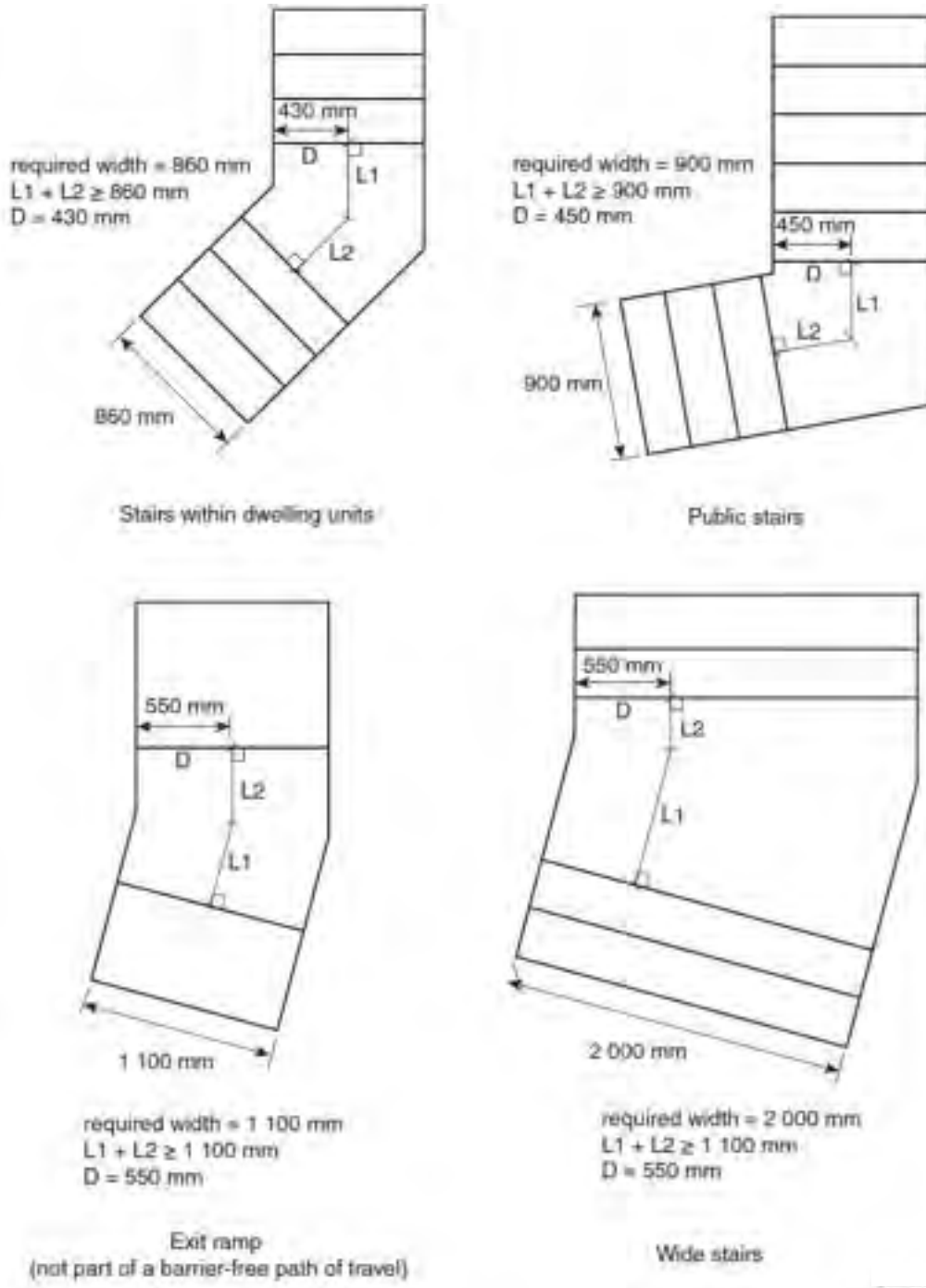


Figure A-3.4.6.4.
Landing Configurations

Notes to Figure A-3.4.6.4.:

- (1) $L1 + L2$ = length of the landing
 = the lesser of the required width of stair or ramp, or 1 100 mm
 See Sentences 3.4.6.4.(2) and 9.8.6.3.(2)
- (2) D = distance from the narrow edge where the length of the landing is measured
 = half the required length of the landing
 See Sentences 3.4.6.4.(3) and 9.8.6.3.(3)

a10.2 A-3.4.6.5.(4) Wider Stairs than Required.

The intent of Sentence 3.4.6.5.(4) is that handrails be installed in relation to the required exit width only, regardless of the actual width of the stair and ramp. The required handrails are provided along the assumed natural path of travel to and from the building.

e7.1 A-3.4.6.5.(10) Continuity of Handrail.

Persons with vision loss rely on handrails to guide them on stairways. A continuous handrail will assist them in negotiating stairs at changes in direction. The extended handrail is useful to persons with physical disabilities to steady themselves before using the stairs. Handrails should, however, return to the wall, floor or post, so as not to constitute a hazard to persons with vision loss.

A-3.4.6.8.(5) Stair Tolerances.

The term “shall not differ significantly” assumes normal construction tolerances.

A-3.4.6.10.(5) Door Swing.

Although it is required that the door on the right hand side of a pair of doors shall swing in the direction of travel through the exit, the direction of swing of the door on the left side will depend on the function of the horizontal exit. If the horizontal exit provides for movement from one building to the adjacent building but does not require movement in the reverse direction, both doors must swing in the direction of travel to the adjacent building. If the design is based upon both buildings providing complementary movement in either direction, then the doors must swing in opposite directions. Location of a required exit sign directly above a door that swings in the direction of travel is deemed to meet the intent of Clause 3.4.6.10.(5)(b).

A-3.4.6.11.(3) Exit Concealment.

Hangings or draperies placed over exit doors may conceal or obscure them.

A-3.4.6.16.(1) Fastening Device.

Turnpieces of a type which must be rotated through an angle of more than 90° before releasing a locking bolt are not considered to be readily openable. The release of a locking bolt should allow the door to open without having to operate other devices on the door.

A-3.4.6.16.(4) Electromagnetic Locks.

Electromagnetic locks are intended for use where there is a need for security additional to that provided by traditional exit hardware. They are not intended for indiscriminate use as alternative locking devices.

The design of these devices requires evaluation to ensure that their operation will be fail-safe in allowing exiting in the event of foreseeable emergencies.

If more than one locking device is used in a building, it is expected that one switch will release and reset all devices simultaneously. If more than one such switch is provided in a building, at least one switch must be installed in the annunciator panel located at the main entrance of the building or, in the case of a building within the scope of Subsection 3.2.6., in the central alarm and control facility for easy access of fire department personnel.

Most importantly, electromagnetic locks are not to be used where panic hardware must be installed. This will ensure that a large number of occupants can exit a building quickly in emergency situations created by either fire or non-fire conditions. It will also ensure that occupants in buildings containing highly hazardous substances can exit quickly unimpeded in an emergency.

In care and treatment facilities, such as hospitals and long term care homes, and residential care facilities, however, because the occupant load is relatively low and the level of staff supervision is generally high, electromagnetic devices may be installed on exit doors at the bottom of exit stairways where panic hardware is required by code to maintain security where necessary.

When installed on doors in fire separations, electromagnetic locking devices must be used in conjunction with positive latching devices designed to hold the doors in the closed position since these locks do not incorporate latches and are released in an emergency. In a fire, keeping doors in fire separations closed is essential to control the spread of fire and smoke.

To enable exiting without delay (especially important in non-fire emergency situation), a manual pull station must be installed in close proximity to the door equipped with an electromagnetic locking device. The operation of this manual pull station will immediately release the electromagnetic locking device and, at the same time, activate the building fire alarm system.

Precautionary measures should be in place to ensure that by-pass switches would be deactivated at the completion of each fire alarm testing. An audible and a visual signal at the annunciator panel and at the monitoring station should provide such assurance.

A-3.4.6.19.(1)(d) Colour Contrast.

The identification of floor and other signs intended to facilitate orientation for visually-impaired persons should offer maximum colour contrast to be effective. For this reason, it is recommended that white on black or black on white be used, as this combination produces the best legibility. It is also recommended that the sign surfaces be processed to prevent glare.

A-3.5.4.1.(1) Elevator Car Dimensions.

In some circumstances, it is necessary to maintain a patient on a stretcher in the prone position during transit to a hospital or to treatment facilities. Inclining the stretcher to load it into an elevator could be fatal or at the very least detrimental to the patient's health. Many ambulance services use a 2 010 mm long by 610 mm wide mobile patient stretcher. As well as space for the stretcher in the elevator, there should be sufficient additional space for at least two attendants who may also be providing treatment during transit. Common elevator units that can satisfy this requirement include:

- a 1 134 kg elevator car with minimum interior dimensions of 2 032 mm wide and 1 295 mm deep with a right or left hand access door. The minimum access door width is 1 067 mm and it must be on the 2 032 mm side of the car.
- a 1 134 kg elevator car with minimum interior dimensions of 2 032 mm deep and 1 295 mm wide with a minimum 915 mm wide access door located on the 1 295 mm side.

A-3.6.2.1.(1) Location of Fuel-Fired Appliances.

Sentence 3.6.2.1.(1) requires that fuel-fired appliances be located in service rooms. It does not allow for their installation in service spaces.

A-3.6.2.5.(1) Combustible Refuse Storage.

Storage of refuse consisting of combustible materials including waste paper, cardboard and plastic, and noncombustible materials such as glass and metallic containers can be accumulated in these rooms for the purpose of recycling. This storage is allowed in consideration of a less stringent collection schedule when compared to that of garbage or refuse, which is collected regularly.

A-3.6.3.1.(1) Vertical Service Spaces.

Sentence 3.6.3.1.(1) does not prohibit the internal subdivision of a vertical service space to allow different building services to be installed in physically separated spaces unless other requirements apply (see, for example, Article 3.2.7.10.). Fire separation requirements apply to the perimeter of the group of service spaces. Article 3.6.3.3. has special requirements for linen chutes and refuse chutes.

a10.1 A-3.6.3.5. Grease Duct Enclosures.

NFPA 96, "Ventilation Control and Fire Protection of Commercial Cooking Operations", presents two options for enclosing grease ducts for commercial cooking equipment: the first option is to use continuous fire-rated building component assemblies to enclose the ducts and the second one consists of installing proprietary, fire-rated, field-applied or factory-built grease duct assemblies in accordance with the manufacturer's instructions. These types of enclosure assemblies are evaluated for their resistance to fire and their ability to protect adjacent combustibles through reduced clearances. Although NFPA 96 references other standards that deal with grease duct assemblies, Sentence 3.6.3.5.(2) requires that CAN/ULC-S144, "Fire Resistance Test – Grease Duct Assemblies", be used to determine the fire-resistance rating of factory-built and field-applied grease duct assemblies.

A-3.6.4.2.(2) Ceiling Membrane Rating.

In construction assemblies that utilize membrane ceiling protection and have been assigned a fire-resistance rating on the basis of a fire test, the membrane is only one of the elements that contribute to the performance of the assembly and does not in itself provide the protection implied by the rating. For the fire-resistance rating of membrane materials used in this form of construction, reference should be made to the results of fire tests which have been conducted to specifically evaluate the performance of this element.

A-3.7.2.1.(1) Window Area Limit.

Part 9 requirements for windows cover a number of subjects, however, this Article refers only to the area limits.

A-3.7.4.2.(1) Sanitary Facilities.

It is assumed that if the sanitary facilities are provided on every storey, the occupant load for the determination of the number of fixtures would be the anticipated occupant load of that storey. If the washrooms are provided in a central location, the number of fixtures should then be based on the total anticipated occupant load for the areas that are served by that washroom.

a2.1 A-3.7.4.2.(8) Plumbing Fixtures for Small, Low Occupancy Uses.

For small restaurants, retail and other small assembly uses with low occupancy loads, the number of washrooms provided may be reduced, where permitted, to provide some flexibility for space planning provided at least one universal washroom is provided in compliance with Sentence 3.8.3.12.(6) and one single washroom is provided and neither washroom is signed for gender.

A-3.7.4.13.(1) Washrooms for Public Use.

The definition of public use clarifies that facilities for public use must have unrestricted access. Since a washroom in a hotel room is restricted for the use of the hotel guest only, it is an example of a washroom that would be exempt from requiring a floor drain. Also, the definition of private use includes a washroom in a hotel suite.

a3 A-3.7.4.15.(1) Clearances for Water Closets.

The minimum clearance in front of a water closet is intended to be measured from the front edge of the seat to:

- the nearest point of the wall or cubicle enclosure,
- another fixture, or
- the washroom door or stall door when the door is in the closed position.

A-3.7.5.3.(1) Shielding of X-Ray Equipment.

Every installation of an x-ray machine or x-ray equipment used for the exposure of persons shall be shielded with a primary and a secondary protective barrier to protect any person who could be exposed to radiation. This protection is required for

- x-ray workers
- persons other than patients undergoing an application of therapeutic or diagnostic x-rays
- persons in adjacent buildings
- persons located outdoors of buildings containing x-ray equipment.

These protective barriers should be designed and installed to comply with requirements of The Healing Arts Radiation Protection Act. Applications for approval for these installations should be addressed to the Ministry of Health and Long-Term Care.

Similarly, every installation of an x-ray machine or x-ray equipment for industrial or veterinary applications shall be shielded with a primary and a secondary protective barrier to protect any person who could be exposed to radiation. This protection is required for

- x-ray workers,
- persons other than x-ray workers,
- persons in adjacent buildings, and
- persons located outdoors of buildings containing x-ray equipment.

The protective barriers should be designed and installed to comply with requirements of The Occupational Health and Safety Act. Applications for approval for these installations should be addressed to the Ministry of Health and Long-Term Care.

a2.1 A-3.8. Barrier-Free Design Assumptions.

This Section contains minimum provisions to accommodate a person using a typical manual wheelchair or other manual mobility assistance devices such as walking aids, including canes, crutches, braces and artificial limbs. The Code also includes provisions to address needs of people with sensory disabilities.

a2.1 A-3.8.1.1.(1)(b) Industrial Occupancies.

Industrial buildings often pose a greater risk to their occupants due to the presence of significant quantities of dangerous materials or the use of hazardous processes. For example, plants which are classified as Group F, Division 2 or 3, may store and use toxic or highly flammable substances in significant quantities, or house processes which involve very high temperatures and which may have a high degree of automation. In some facilities, particularly in primary industries such as forestry and metallurgy, the construction normally used and the operations carried out within the space can make compliance with the requirements of Section 3.8. impractical. It is therefore intended that these requirements be applied with discretion in buildings of Group F, Division 2 or 3 major occupancy. However, where industrial buildings contain subsidiary occupancies, such as offices or showrooms, it is reasonable to require that accessibility be provided in these spaces.

a2.1 A-3.8.1.1.(1)(d) Camps for Temporary and Emergency Workers.

The exemption of camps for housing of workers from barrier-free design requirements is intended to exempt accommodations for seasonal workers such as agricultural workers or emergency workers such as firefighters working in remote areas.

a2.1 A-3.8.1.2. Barrier-Free Entrances.

A barrier-free path of travel should be provided from the sidewalk or roadway and parking areas to a barrier-free building entrance. This route should be located so that persons with disabilities do not have to pass behind parked cars. The number of barrier-free entrances to a building must be not less than the minimum number required in Table 3.8.1.2. in order to provide more general and equitable access to the building and should include the principal entrance. For the purpose of determining the number of entrances to a building, several adjacent doors in a bank of doors are considered to be a single entrance. The principal entrance to the building is the entrance that is normally used by the public or the building occupants.

a10.1 A-3.8.1.3.(2) Surfaces in a Barrier-Free Path of Travel.

Floor finishes, including walk-off mats and carpet, should be selected, installed and securely fixed to provide a firm and stable surface so that persons using wheelchairs, walkers or other mobility aids can easily travel over them without tripping or expending undue energy. Other than very high-density, short-pile carpeting, most carpeting does not meet these criteria.

Furthermore, where the path of travel is exposed to intense light conditions, such as daylight or directional lighting, a low-glare or matte floor surface should be selected as glare from floor surfaces can bother all users and be particularly problematic for individuals with a vision impairment. For the same reasons, heavily patterned flooring should also be avoided.

a2.1 A-3.8.1.3.(4) Unobstructed Space.

The 1800 mm by 1800 mm space spaced every 30 m provides a layby area where two wheelchairs can pass.

a2.1 A-3.8.1.3.(5) and (6)(b) Reduced Headroom.

Wherever an overhead obstruction occurs within or adjacent to a barrier-free path of travel such as the underside of a stairway or escalator or a building structural element, a cane-detectable barrier will provide an effective warning to people with no or low vision that headroom is reduced and the path is obstructed to prevent them from moving toward the obstruction.

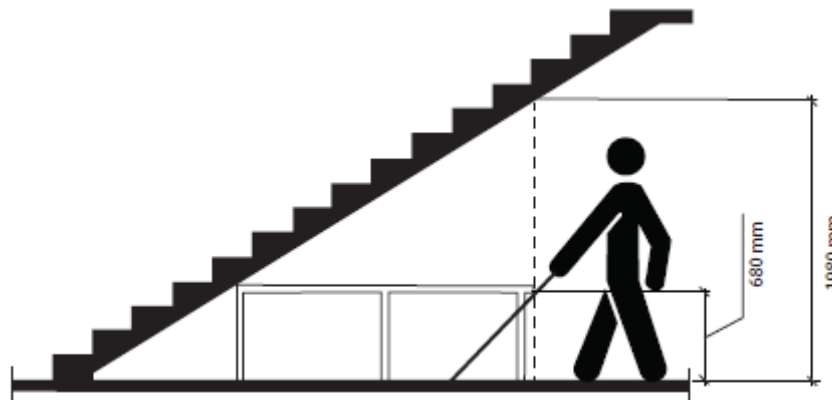


Figure A-3.8.1.3.(5) and (6)(b)
Reduced Headroom

A-3.8.1.4.(1) Access to Storeys Served by Escalators and Moving Walks.

In some buildings, escalators and inclined moving walks are installed to provide transportation from one floor level to another floor level so as to increase the capacity to move large numbers of persons. Some buildings located on a sloping site are accessible from street level on more than one storey and an escalator or inclined moving walk is provided for internal movement from floor to floor. In both these situations, a person with a physical disability must be provided with an equally convenient means of moving between the same floor levels within the building. A wheelchair user should not be required to travel outside the building in order to gain access to another level. This can be accomplished by providing an elevator or a platform-equipped passenger-elevating device.

a2.1 A-3.8.1.5.(1) Controls.

Building controls that are intended to be operated by the occupants include thermostats, light switches, intercoms and other controls for building use and comfort. It is not intended to include those controls that are secured for use by building operations, maintenance and management personnel.

Light switches, intercoms and similar devices located within a barrier-free path of travel should be located between 900 mm and 1100 mm above the finished floor. Thermostats should be mounted at 1200 mm on centre above the finished floor for the optimal operation.

a2.1 A-3.8.2.1.(1) Access to Rooms and Facilities.

If barrier-free access is required into suites or rooms in Subsection 3.8.2., it is intended that access be provided, with some exceptions identified in Sentence 3.8.2.1.(3), throughout each room or suite. Some examples of where barrier-free access is required are as follows:

- within rooms or areas that serve the public or are designated for use by visitors, including areas in assembly occupancies with fixed seats, display areas and merchandising departments,
- within rooms or areas for student use in assembly occupancies,
- within general work areas, including office areas,
- within general use or general service areas, including shared laundry areas in residential occupancies, recreational areas, cafeterias, lounge rooms, lunch rooms and infirmaries,
- within sleeping rooms in hospitals and long term care homes,
- (if installed), into at least one passenger elevator or elevating device conforming to Article 3.8.3.5.,
- into washrooms described in Article 3.8.2.3.,
- to any facility required by this Section to be designed to accommodate persons with physical disabilities,
- onto every balcony provided in conformance with Sentence 3.3.1.7.(2),
- to service counters used by the general public (examples include ticket counters, refreshment stands, drinking fountains, cafeteria counters, checkout counters and bank service counters)
- into 10% of hotel suites, (not more than 20 suites required), and
- within 15% of residential suites in an apartment building from the suite entrance door into at least one bedroom and bathroom at the same level as the suite entrance.

a2.1 A-3.8.2.1.(1)(b) and (c) Rooftop Amenity Spaces.

External rooftop areas of buildings that are designed for use as amenity spaces for building occupants must be made accessible to people with disabilities. This includes rooftop terraces, patios and barbecue facilities and requires that a barrier-free path of travel be provided from the floor area to the rooftop amenity space. Exterior roof spaces that are only accessed for the purpose of building and equipment maintenance and operations are not required to be barrier-free accessible and will continue to be exempt from barrier-free design requirements under Clause 3.8.2.1.(3)(f).

a2.1 A-3.8.2.1.(2) Portions of Floor Areas not Required to be Barrier-Free.

The permission to waive a barrier-free path of travel for wheelchair access to certain specified areas of a building is not intended to waive accessibility requirements for persons with physical disabilities who do not require special provision for access to raised or sunken levels. The concept of providing similar amenities and facilities applies, among other things, to food, beverage, and entertainment facilities within restaurants, and to window areas providing a view of an exterior attraction. Availability of specific spaces depends on reservation policy and the sequence in which patrons arrive at a restaurant or other facility, and therefore is beyond the scope of this Code.

Accessibility “within” a floor area is intended to mean that in general all normally occupied spaces are to be accessible, except where essential obstructions in the work area would make a barrier-free path of travel hazardous. Examples of excluded floor areas could include small raised office areas in retail and industrial premises, storage platforms in industrial occupancies, repair garages and areas within commercial kitchens.

Where a floor area does not require a barrier-free path of travel, certain barrier-free design provisions of Section 3.8. will still be applicable. These requirements can provide greater accessibility for persons with limited mobility who do not use wheelchairs or for those with sensory disabilities. People using walking aids, service animals or those with hearing and vision loss may still be able to climb stairs or use escalators. Accessibility features such as wider door openings, lever door handles and larger washroom stalls can also assist other building users.

The applicable requirements include:

- 3.8.1.3.(6) – Headroom and walking surfaces
- 3.8.2.3.(6) – Non-barrier-free washrooms
- 3.8.3.1.(6) – Accessibility signs
- 3.8.3.3.(19) – Doors, door hardware and vision panels
- 3.8.3.8.(10) – Ambulatory water closet stalls
- 3.8.3.10.(5) – Urinals
- 3.8.3.11.(5) – Lavatories
- 3.8.3.15.(5) – Counters for telephones
- 3.8.3.16.(4) – Drinking fountains

a2.1 A-3.8.2.1.(2)(b) Exemptions from Barrier-Free Path of Travel for Small Buildings.

Some small buildings are restricted in building area by lot size, including small infill properties between existing buildings. In those cases, it may not be feasible to require an elevator for the building.

a2.1 A-3.8.2.1.(3) Exemptions for Service Facilities.

The concept of wheelchair accessibility does not extend to building service facilities. Nor does it extend to all floor levels within a storey, e.g., mezzanines not served by an elevator. Mezzanines that are accessible by an elevator are not excluded.

a2.1 A-3.8.2.1.(4) Designated Wheelchair Spaces and Adaptable Seating.

Spaces designated for wheelchair use, and for adaptable seating, should be distributed in various locations throughout the venue in order to provide a choice of seating location for patrons. Seating spaces should be located adjacent to a barrier-free access aisle or an open space to facilitate ease of manoeuvring a wheelchair into position or to facilitate a side transfer to a fixed adaptable seat.

a2.1 A-3.8.2.1.(5) Number of Apartments Required to be Barrier-Free.

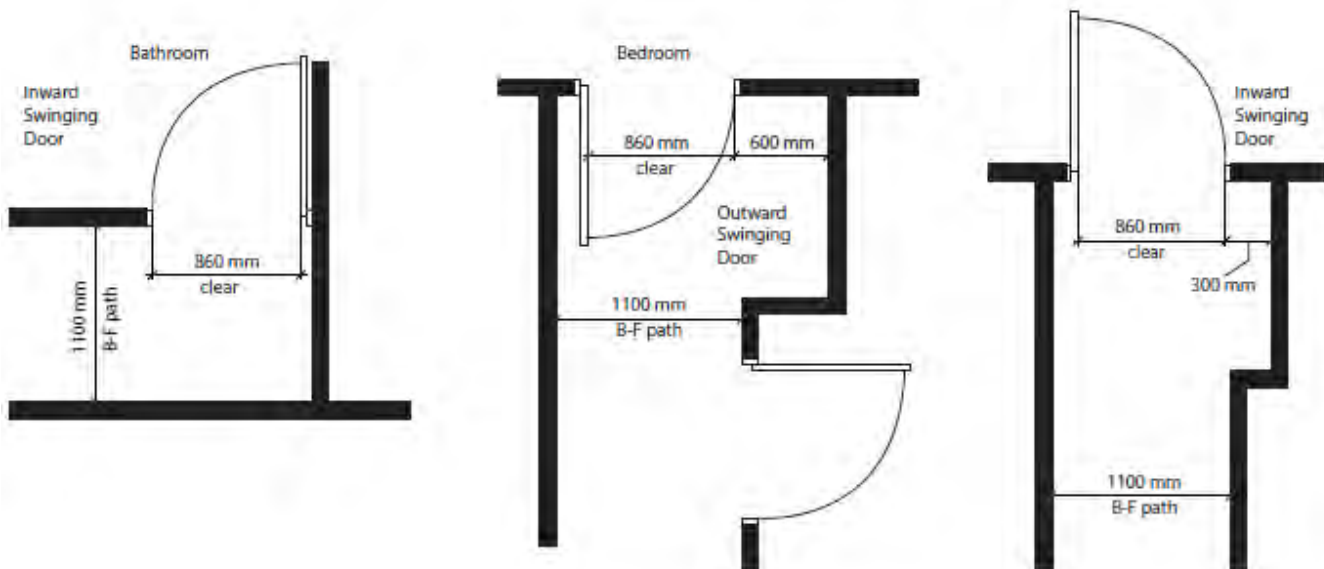
The intent behind Sentence 3.8.2.1.(5) is that, in calculating the 15% of apartments in a multi-unit apartment building required to be barrier-free, the 15% of units is determined based on whole numbers as indicated in the examples set out in Table A-3.8.2.1.(5) and not based on fractions of units.

**Table A-3.8.2.1.(5)
Minimum Number of Apartments Required to be Barrier-Free**

Number of Apartments	Minimum Number of Barrier-Free Apartments
1 to 6	0
7 to 13	1
14 to 19	2
20 to 26	3
27 to 33	4
34 to 39	5
Column 1	2

a2.1 A-3.8.2.1.(5)(a) and (b) Access to Bedrooms and Bathrooms in Apartments.

This requirement ensures that a person using a wheelchair can enter a bedroom and a bathroom within 15% of apartment suites and 10% of hotel and motel suites. A barrier-free path of travel and clearances on the latch side of the doors to the designated bedroom and bathroom must be provided.



**Figure A-3.8.2.1.(5)(a) and (b)
Access to One Bedroom and One Bathroom in 15% of Apartments**

a3 A-3.8.2.1.(6) Residential Bathrooms.

The intent of the barrier-free features required in 15% of apartment bathrooms, is to provide basic manoeuvrability into, and within, the space for a wheelchair user. The door swing may overlap the turning circle within the bathroom as long as there is sufficient space for a wheelchair user to clear the door and close the door. The bathroom is not required to include a barrier-free bathtub or barrier-free shower meeting the requirements of Article 3.8.3.13. The intent is not to provide accessibility for a full range of disabilities which may require additional features to accommodate the specific needs of an individual resident. However, stud wall reinforcement for the future installation of grab bars is required in the main bathroom in all dwellings as set out in Articles 9.5.2.3. and 3.3.4.9.

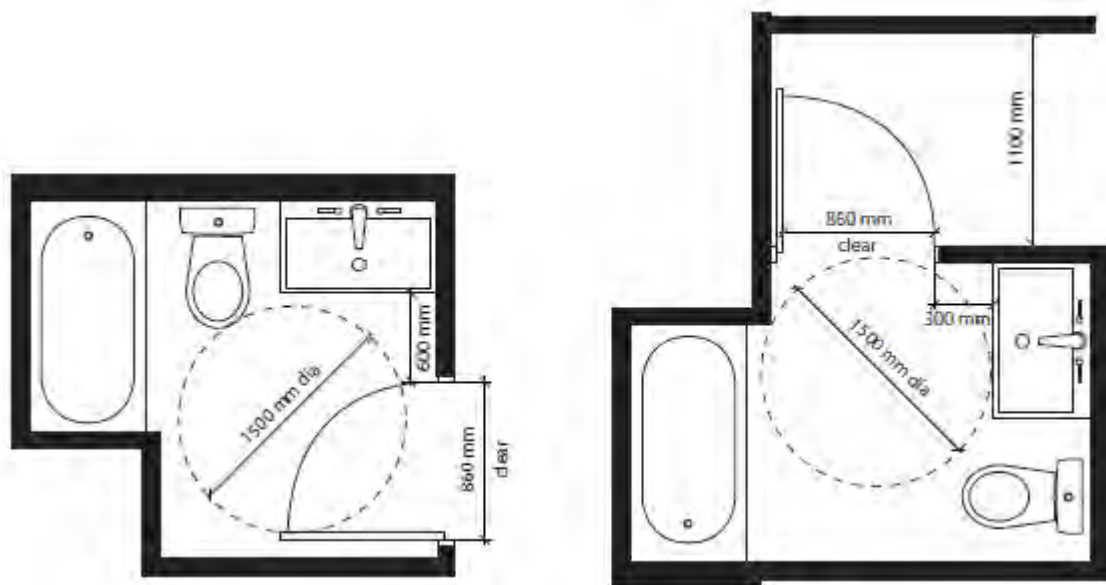


Figure A-3.8.2.1.(6)
Residential Bathrooms

A-3.8.2.1.(7) Distribution of Apartments with Accessible Features.

The intent is to provide a variety of suite sizes and locations and not locate all suites with barrier-free design features on the same floor. The intention is to provide a level of visitability to apartments. Given the broad range of disabilities and the specific needs of people with disabilities in their home settings, the accessibility provisions may not provide all of the features required by an individual's personal needs that cannot be anticipated when the building is constructed initially.

The intent behind Sentence 3.8.2.1.(7) is that, in determining the proportion of barrier-free suites by unit size, the total number of barrier-free suites and the percentage of suites of each type (by number of bedrooms) should be calculated first. Those percentages should be multiplied by the total number of barrier-free suites required. For example, in a 40 unit apartment building with 30 one-bedroom and 10 two-bedroom units, 6 suites in total would be required to be barrier-free. The proportional breakdown of required barrier-free suites would be 75% or 5 one-bedroom suites and 25% or one two-bedroom suite. The proportion of units is also determined based on whole numbers and not based on fractions of units as long as the total number of barrier-free suites are provided.

- a3** Studio or bachelor apartments are a specific type suite and are intended to be counted separately when determining the proportion of suites, by type and size, in a building. Where studio or bachelor suites are provided, a proportionate number of studio or bachelor suites should also be accessible even though those suite types do not include a separate bedroom. For example, if 25% of the units in a building are studios, 50% are one-bedroom units and 25% are two-bedroom units, the same proportions should be reflected in the 15% of total units required to include barrier-free design features. The Building Code does not differentiate one- or two-bedroom units from one- or two-bedroom units with dens. The intent is that a range of unit types and sizes are available as accessible units.

A-3.8.2.2.(1)(a) Access to Exterior Parking.

It is not intended that a separate accessible entrance must be provided from the exterior parking area. The designer may choose to designate the entrance leading to the exterior parking area as the required entrance or provide a properly identified and unobstructed path of travel from the parking area to the entrance which is accessible. The entrance chosen should, in any case, be one normally used by the occupants of the building. Long paths of travel are not recommended.

a2.1 A-3.8.2.3. Washrooms.

The primary intent of this requirement is that all regular washrooms be made accessible to all persons, including persons with disabilities, primarily persons who must use a wheelchair.

The exception in Clause (5)(b) recognizes situations where several washrooms may be provided on a large floor area. In such a case, not all washrooms need to be barrier-free, provided that a barrier-free washroom is available within a reasonable distance (45 m) of one that is not barrier-free and that the location of that barrier-free washroom is clearly indicated as required by Sentence 3.8.3.1.(3).

Clause 3.8.2.3.(5)(c) is intended to address “strip malls” (a shopping mall with no public corridor). Section 3.7, which requires plumbing facilities, does not address the concept of suite and could permit, for instance, a shopping mall containing only Group E occupancies (assuming the mall is more than 100 m²) to have only one washroom for each sex located in any one of the suites. It is desirable however that such washrooms be located so as to be accessible at all times, since the owner or tenant of one suite has no control over the activities of another. Such buildings may either provide public barrier-free washrooms in a central location or washrooms which can accommodate disabled persons in each suite. This arrangement relieves any one tenant from having to provide “public” washrooms. Hence, the exception for suites of less than 300 m² is meant as a relaxation to avoid an unnecessary burden on small facilities but should not be construed as meaning that such buildings need not provide accessible washrooms.

a2.1 A-3.8.2.3.(2) Minimum Number of Universal Washrooms.

The requirements for the number of universal washrooms in buildings are set out in Article 3.8.2.3. and Table 3.8.2.3. A. Sentence 3.8.2.3.(2) refers back to Subsection 3.7.4. which sets out the number of washrooms required in buildings by occupancy.

The intent of the new requirements in Table 3.8.2.3.A is to provide additional universal washrooms in uses and occupancies where washrooms are required and not to require washrooms where they had not been required previously. For that reason the requirements are linked back to Subsection 3.7.4. For example, in the case of a high-rise apartment building, floors with only apartment units and without any common amenity spaces, would not require a universal washroom, nor would 3 levels of underground parking below the building.

Using the ratio of ‘1 universal washroom for every 3 storeys’ is a way to determine the number of universal washrooms in a building but without specifying where they should be located. The intent of the Code is to provide designers and building owners flexibility to locate the washrooms as appropriate to the building design and operation. For example, a six storey office building would require 2 universal washrooms (1 per 3 storeys) but those could both be on the same storey or on different storeys – not necessarily on the first and fourth floors or on every third storey.

a2.1 A-3.8.2.3.(3) Minimum Number of Barrier-Free Water Closet Stalls.

Washrooms that contain barrier-free washroom stalls and barrier-free lavatories, typically meet the needs of single users with disabilities. The requirements for universal washrooms, in addition to barrier-free washrooms, accommodate people with disabilities who require assistance from a same or opposite gender care giver.

a2.1 A-3.8.2.3.(5)(b) Individual Washrooms.

Washrooms, in excess of those required under Subsection 3.7.4., that are provided for private or individual use within an individual suite where washrooms for public use are provided elsewhere in the building, are not required to meet barrier-free design requirements. This could include a single user washroom that is part of a private office or a small retail store.

a2.1 A-3.8.2.3.(6) Ambulatory Water Closet Stalls.

Washrooms on storeys that are not required to have a barrier-free path of travel are still required to provide a washroom stall in each washroom that includes certain barrier-free design elements in order to accommodate people with disabilities who are ambulatory but still need some supports.

a2.1 A-3.8.2.4.(1) Number of Hotel Rooms Required to be Barrier-Free.

The intent behind Sentence 3.8.2.4.(1) is that, in calculating the 10% of hotel rooms required to be barrier-free, the 10% of units is determined based on whole numbers and not based on fractions of units. A small hotel with 9 suites or fewer, would not require any barrier-free rooms.

a2.1 A-3.8.2.4.(7) Emergency Power Outlet.

An outlet on emergency power is required to provide power for a guest with a disability who needs constant support from equipment such as a ventilator or oxygen concentrator generator.

The emergency power receptacle need only be provided in one of the suites required to have accessible features. This outlet must be identified and signed as being on emergency power.

a2.1 A-3.8.3.1. Accessibility Signs.

The international symbol of access, as shown in Figure 3.8.3.1.A below, indicates to persons with disabilities that they will have reasonable freedom of movement within the building. It usually has a blue background, but if, because of lighting conditions, it may not stand out, it can be set on a white background. An arrow can be added to either side or to the top or bottom to indicate direction or the location of an accessible space or facility.

An international sign, shown in Figure A-3.8.3.1.B, indicating accessibility for persons with hearing disabilities, should be used to indicate the availability of variable volume controls on telephones, assistive listening systems, and text telephones (TT). These latter devices may also be referred to as teletypewriters (TTY) or telecommunications devices for the deaf (TTD).



Figure A-3.8.3.1.A
Signs Indicating Accessible Facilities



Figure A-3.8.3.1.B
Signs for Assistive Listening Facilities

a2.1 A-3.8.3.1.(5) Height of Accessibility Signs.

This requirement only applies to those signs which are required under the Building Code including those for washrooms, directional signs to building entrances and parking areas.

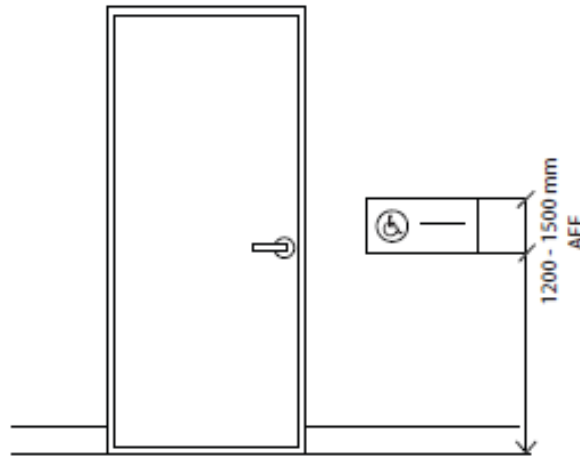


Figure A-3.8.3.1.(5)
Height of Accessibility Signs

a2.1 A-3.8.3.2.(1)(h) Tactile Indicators at Exterior Walks.

The requirement for a tactile indicator surface installed at specified locations is to provide a tactile signal that an individual is moving toward a potential hazard such as a curb cut at a vehicular route or the edge of a level rapid transit platform.

a2.1 A-3.8.3.3.(1) Doorway Width.

Every doorway that is located in a barrier-free path of travel must have a clear width of not less than 860 mm when the door is in the open position and therefore it is important that this dimension be measured correctly. The 860 mm clear dimension has been developed from research which shows that this dimension provides access for 95% of wheeled mobility devices.

Figure A-3.8.3.3.(1) shows a door opened to 90°. The clear width of not less than 860 mm is measured from the face of the door to the outside edge of the stop on the door frame. It is not sufficient just to measure the inside width of the door frame or the width of the door panel. There should be no projections into the required clear opening width lower than 865 mm above the finish floor or ground. Projections into the clear opening width between 865 mm and 2030 mm above the finish floor or ground should not exceed 100 mm.

Other factors, including location of door stops other than on the door frame, and the installation of door closers and exit devices, should be taken into account. The intrusion of a door handle into the space is of lesser importance. It is recognized that there are many types of door frame and door mounts but the overall objective is to maintain a clear width of not less than 860 mm.

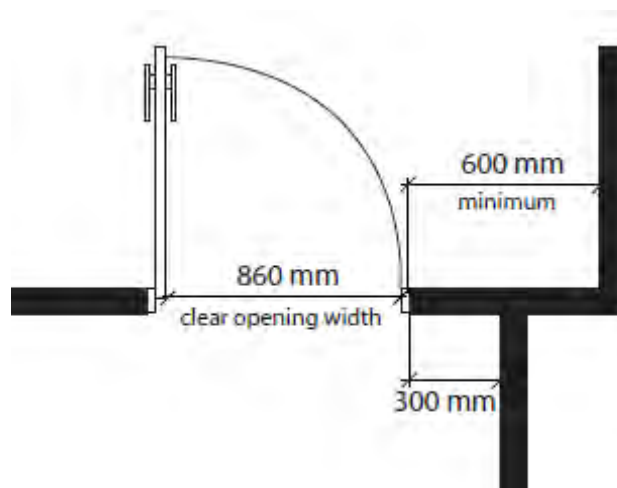


Figure A-3.8.3.3.(1)
Clear Doorway Width

a2.1 A-3.8.3.3.(2) Washrooms and Bedrooms in Residential Occupancies.

This requirement ensures that the width of a doorway to the washroom and the bedrooms in relation to the corridor width leading to those rooms in a dwelling unit or a hotel/motel suite can provide for basic manoeuvrability into and out of the room. The Code does not require these washrooms (except the 15% required by Sentence 3.8.2.1.(5) and 10% required by Article 3.8.2.4.) to be barrier-free.

a2.1 A-3.8.3.3.(3) Accessible Door Handles.

Door handles that can be operated with a closed fist include lever-style handles which are useable by most persons with limited hand mobility and will meet the intent of this requirement. Lever handles with an end return towards the door are less prone to catch the clothing of someone passing through the doorway. Where the door is a sliding door with manual controls, it shall be configured so that the hardware is exposed and usable from both sides when the sliding door is in the open position.

a2.1 A-3.8.3.3.(4) Doors with Power Operators.

Doors equipped with a power operator activated by a pressure plate identified with the international symbol of access or, where security is required, by a key, card or remote device, and that can otherwise be opened manually meet the intent of the requirement. The device selected should consider ease of use by people with disabilities including those with limited hand motion and dexterity. The location of these activating devices should ensure that a wheelchair will not interfere with the operation of the door once it is activated. Where the power door operator is provided for one leaf of a pair of double, out-swinging doors, the door operator should be located so that it is as close as possible to the latch side or, beyond the door swing so that the door does not obstruct the path of travel.

Swinging doors equipped with power operators which are activated automatically and open into passing pedestrian traffic should be provided with a guard or other device designed to prevent pedestrians from stepping in the swing area of the door. These guards or devices should be detectable by blind persons. For example, inverted U-shaped guards should have an additional rail at a height not more than 680 mm so that it is detectable by the long cane. These doors should also have a device (mat or other sensor) on the swing side to prevent the door from opening if someone is standing in the swing area.

A-3.8.3.3.(8) Air Pressure Differences.

Differences in air pressure on opposite sides of a door may be due to the operation of mechanical systems such as those associated with smoke control. So-called “stack action” in buildings in winter can also cause differential pressures due to the buoyancy of warm air. Stack action is usually most noticeable between stairwells and the remainder of the building, and at the entrances to buildings; the taller the building, the greater the effect. Doors with automatic closers have to operate with sufficient opening forces to allow the return action to overcome the differential pressure.

A-3.8.3.3.(9) Delayed Action on Door Closers.

In some circumstances, closers with a delay feature which keep the door open for several seconds before it begins to close might be desirable. However, closers with this feature have limited back-check, a feature of a normal door closer where resistance to opening increases as the door reaches the full arc of swing. Doors equipped with this type of closer are more susceptible to damage should the door be opened with too much force or should someone try to force it closed, thinking the closer has failed to operate. Delayed action closers are not recommended for such occupancies as schools.

a2.1 A-3.8.3.3.(10) Clearances at Doorways.

Sufficient clearance must be provided on the latch side of doors for a user to operate the door opening mechanism and open the door without interference from the wheelchair. This is particularly important where the door swings toward the approach side where a larger clearance of 600 mm is required.

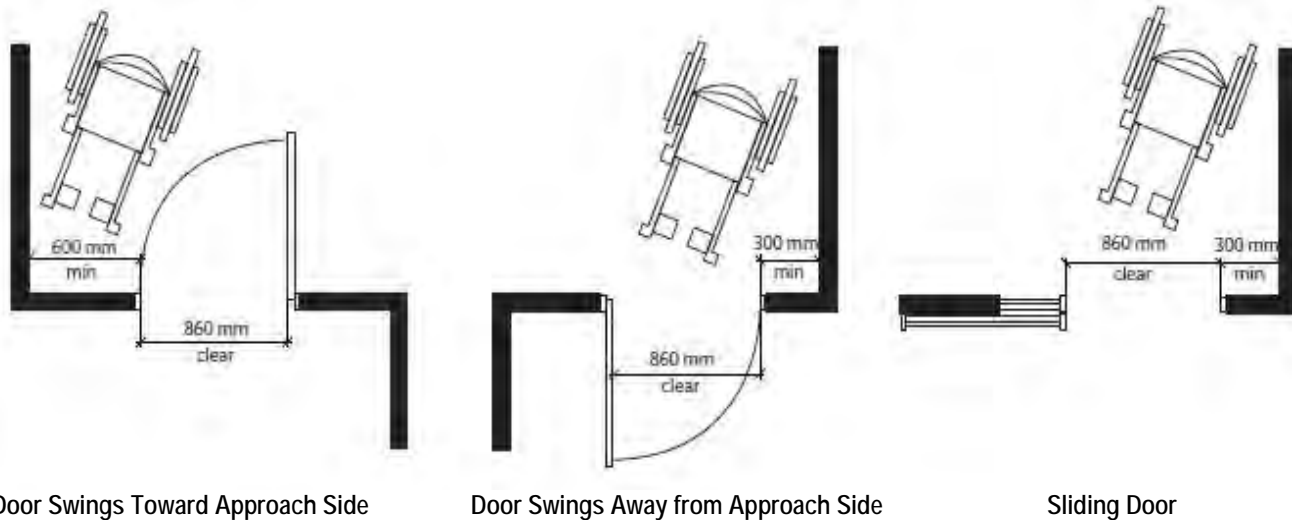


Figure A-3.8.3.3.(10)
Doorway Clearance

a3 A-3.8.3.3.(11)(b) Doors in a Series.

Where there are doors in a series such as an entry or washroom vestibule, there must be a full 1500 mm diameter turning circle or a linear dimension of 1500 mm provided within the vestibule that is clear of the door swing to ensure that persons using wheelchairs or other mobility devices can close the door behind them before proceeding through the next door in the series.

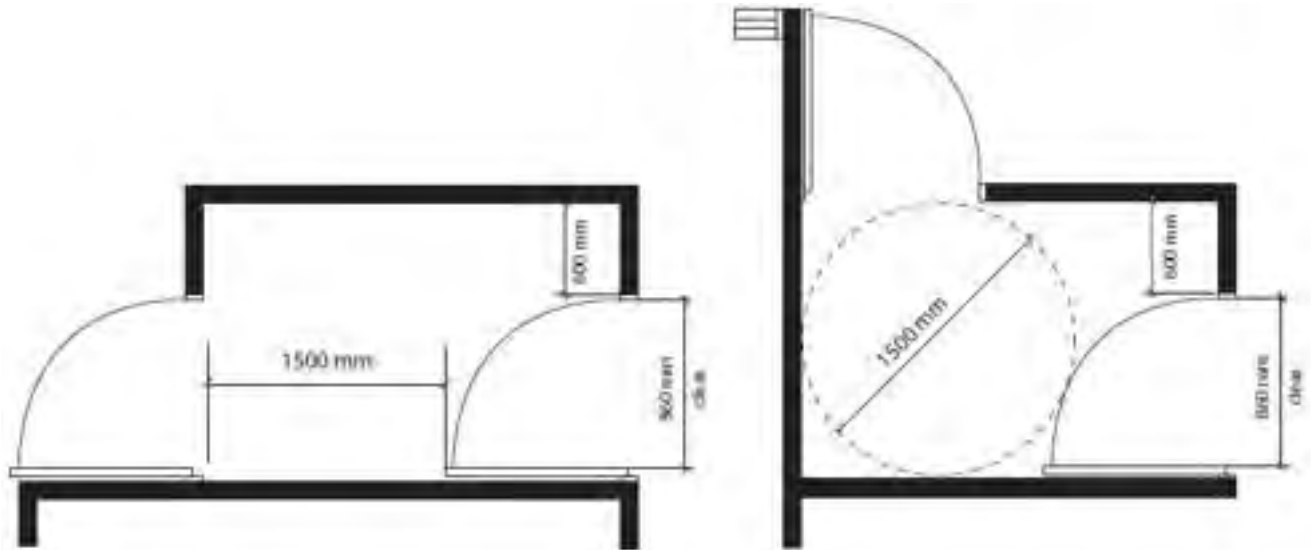


Figure A-3.8.3.3.(11)(b)
Doors in a Series

a2.1 A-3.8.3.3.(17)(c) Vertical Power Door Operators.

The height range permitted for the location of a power door operators in Subclause 3.8.3.3.(17)(c)(ii) allows for the installation of vertical power door operators, either wall- or floor-mounted, that can be operated by a closed fist, a foot or other pressure anywhere within the height of the door operating device.

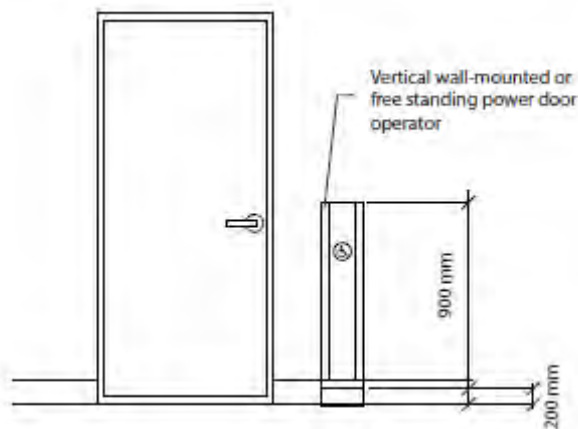


Figure A-3.8.3.3.(17)(c)
Vertical Power Door Operator

a2.1 A-3.8.3.3.(18) Proximity Scanners as Door Operators.

Where a proximity scanner is utilized it must be set to scan a lower height to ensure that a person using a seated mobility device will trigger the opening of the door.

a2.1 A-3.8.3.3.(19)(b) Manual Door Operators.

The door opening device referred to in Clause 3.8.3.3.(19)(b) is not required to be a power door operator. A manual door opener with lever handles will meet the intent of the Code.

a2.1 A-3.8.3.4.(1)(b) Ramp Slopes.

Although Article 3.8.3.4. permits slopes on ramps as great as 1 in 12 for distances of up to 9 m, gradients of 1 in 20 are safer and less strenuous. When limited space is available, as may be the case during renovations, ramps of up to 1 in 12 should be restricted to lengths not exceeding 3 m whenever possible.

a2.1 A-3.8.3.4.(1)(c) Landing Design at Doorways Leading to Ramps.

A level landing surface at doorways leading to ramps provides a level and stable surface for people using wheeled mobility devices and other mobility aids to stop and manoeuvre clear of the door swing.

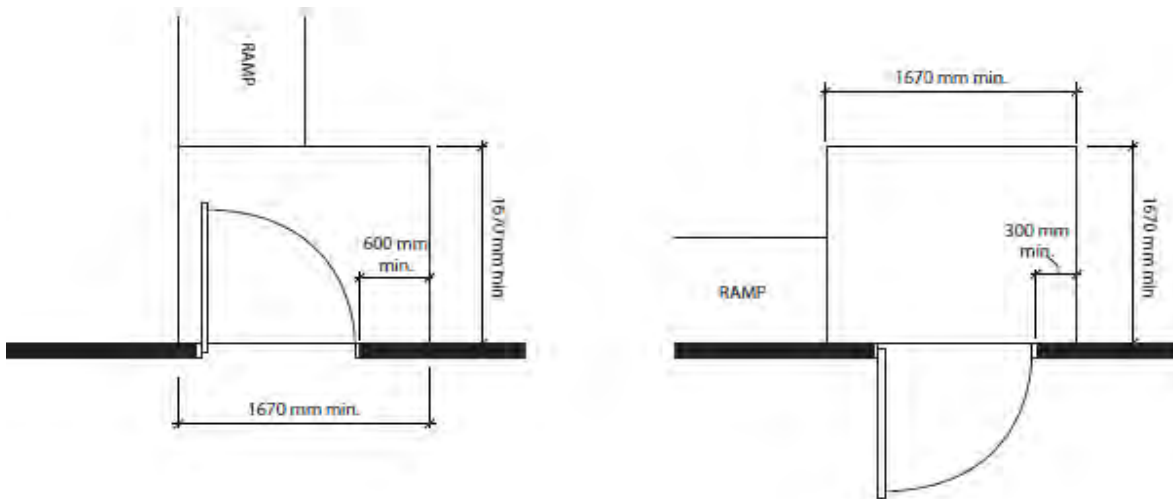


Figure A-3.8.3.4.(1)(c)
Landing Design at Doorways Leading to Ramps

a2.1 A-3.8.3.4.(2) Fixed Seating on Sloped Floors.

In an assembly room with fixed seating on a sloped floor, such as a theatre, the limitation on floor slope is intended to apply only to the required barrier-free access leading to spaces for persons using wheelchairs described in Sentence 3.8.2.1.(3) and not to aisles and portions of floors serving only fixed seating for ambulatory persons.

a2.1 A-3.8.3.4.(3) Sloped Floors.

A floor with a slope of 1:20 or less need not be designed as a ramp.

a2.1 A-3.8.3.6.(1)(c) Locating Wheelchair Spaces, Adaptable and Companion Seating.

People with disabilities who require either a wheelchair space or an adaptable seat may attend an event with a companion who needs no special seating accommodation. For that reason, the companion seat required beside a wheelchair space is intended to be a standard seat provided for the facility.

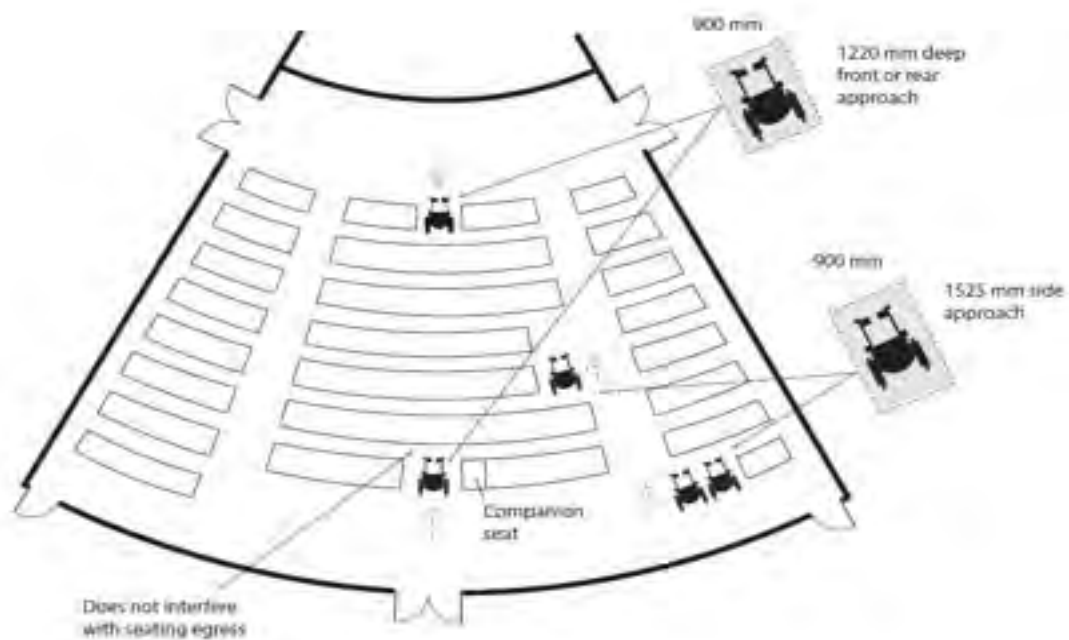


Figure A-3.8.3.6.(1)(c)
Accessible Seating Spaces

A-3.8.3.7.(1) Assistive Listening Devices.

Wireless sound transmission systems, such as FM, infrared or magnetic induction loop, improve sound reception for the hard of hearing by providing amplification which can be adjusted by each user while blocking out unwanted background noise. These systems transmit a signal that is picked up by special receivers available for use by people with a hearing impairment, whether or not they use a hearing aid. Neither system interferes with the listening enjoyment of others.

The transmitter can be jacked into an existing P.A. system amplifier or used independently with microphones. The induction loop system requires users to sit in the area circumscribed by the loop; though installation of the loop is relatively simple, the installer should be knowledgeable about these systems if proper functioning is to be achieved. FM or infrared systems can be designed to broadcast signals which cover the entire room and, thus do not restrict seating to any one area. Figures 3.8.3.7.A and 3.8.3.7.B show the general configuration of FM and infrared systems. Although portable systems (FM in particular) are available, these are best suited to small audiences. Generally, the systems installed in church halls, auditoria, theatres and similar places of assembly are not easily portable, as they are installed in a fixed location by a sound technician and form an integral part of the P.A. system of the room or building.

Hard wired systems (where a jack is provided at a particular seat) will not meet this requirement unless adequate provisions are made to accommodate persons with hearing aids. In choosing the most appropriate system, a number of factors must be taken into account including cost, installation and maintenance, suitability to the audience, ease of operation and the need for privacy. Information on designers and suppliers of these systems may be obtained from such organizations as the Canadian Hearing Society.

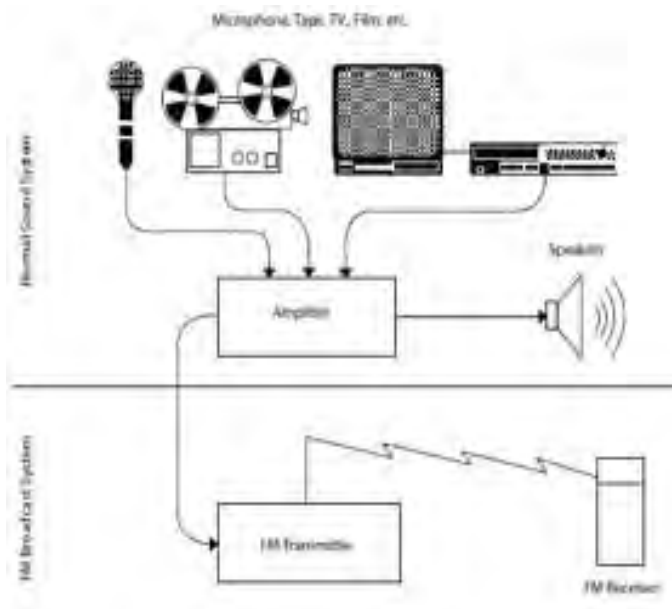


Figure A-3.8.3.7.(1)A
FM Sound Transmission System

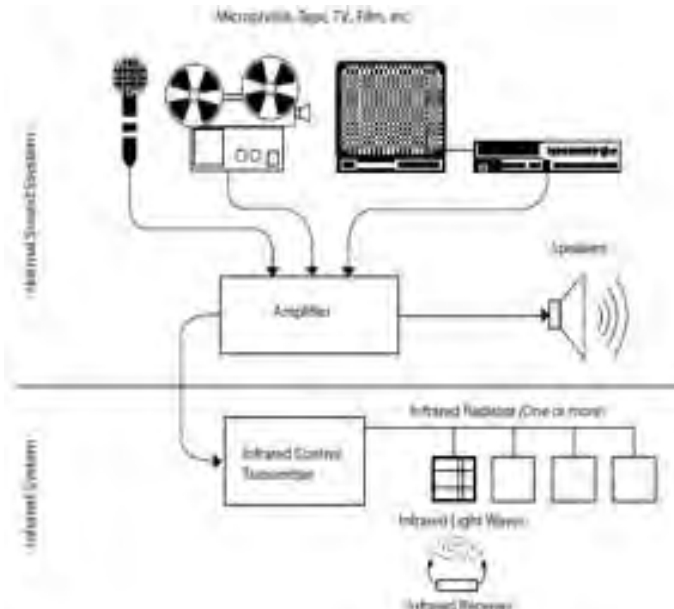


Figure A-3.8.3.7.(1)B
Infrared Sound Transmission System

a2.1 A-3.8.3.8.(1)(a) Water Closet Stalls.

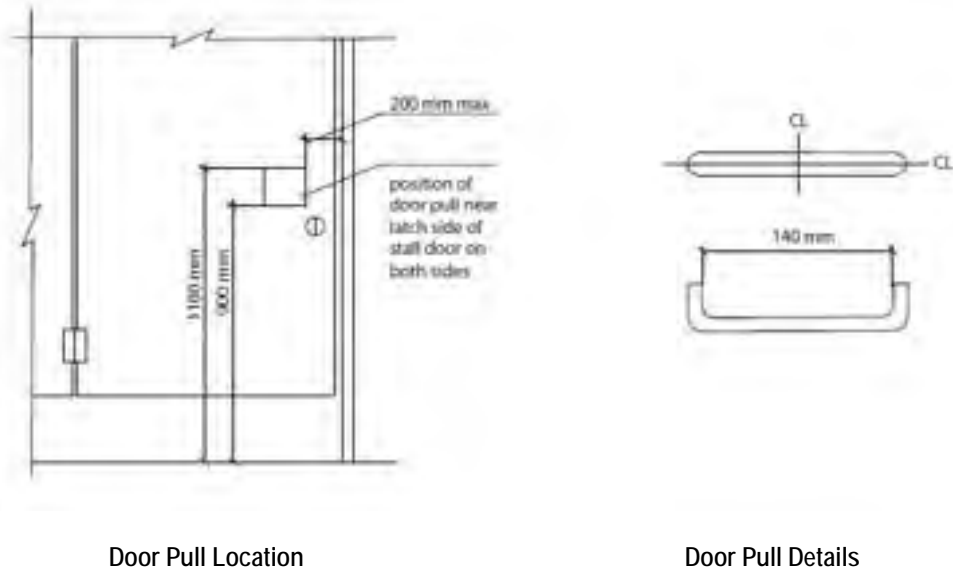
The wheelchair turning circle within the stall may not overlap space of an inward swinging door or the area below plumbing fixtures.

a10.1 A-3.8.3.8.(1)(c)(iii) Water Closet Stalls.

Doors to water closet stalls for persons with disabilities should swing outward and preferably against a side wall.

a10.1 A-3.8.3.8.(1)(c)(v) Washroom Stall Door Pulls.

The purpose of the door pull mounted on both sides of the stall door is to assist those with limited arm strength to open and close the door. The pull should be located close to the latch side on both the inside and outside surfaces of the door. Pulls mounted close to the latch side require less strength to pull the door open or closed than a pull located close to the hinge side. The door pull should consist of a D-shaped handle mounted horizontally. The centerlines are the lines drawn through the long axis and the short axis of the handle. In the horizontal position, the centerline of the short or transverse axis must be located at between 200 mm and 300 mm from the latch side of the door, and the long or longitudinal axis must be located between 900 mm and 1 100 mm from the floor.



Door Pull Location

Door Pull Details

Figure 3.8.3.8.(1)(b)(v)
Washroom Stall Door Pulls

a3 A-3.8.3.8.(1)(f) Washroom Clearances.

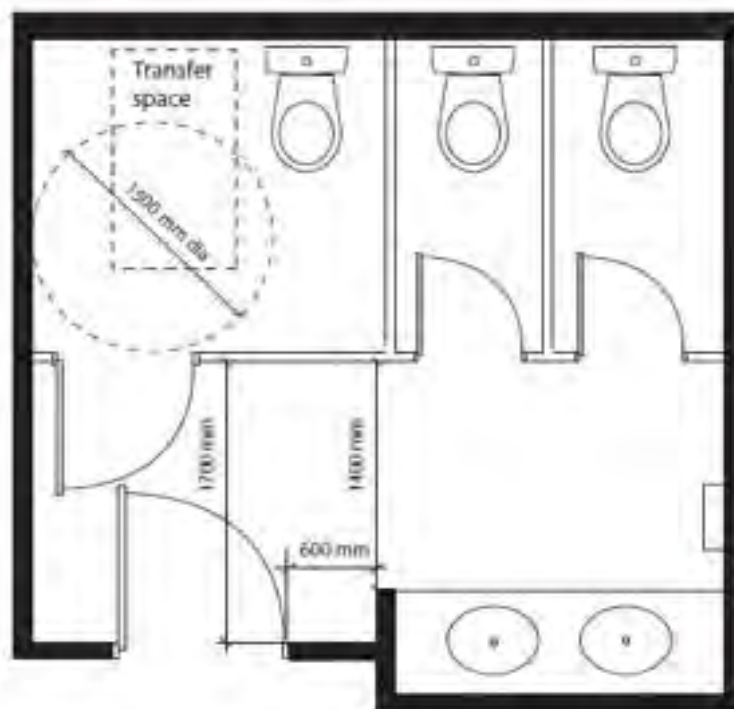


Figure A-3.8.3.8.(1)(f)
Washroom Clearances

a2.1 A-3.8.3.8.(2)(b) Transfer Space on Both Sides of Water Closet.

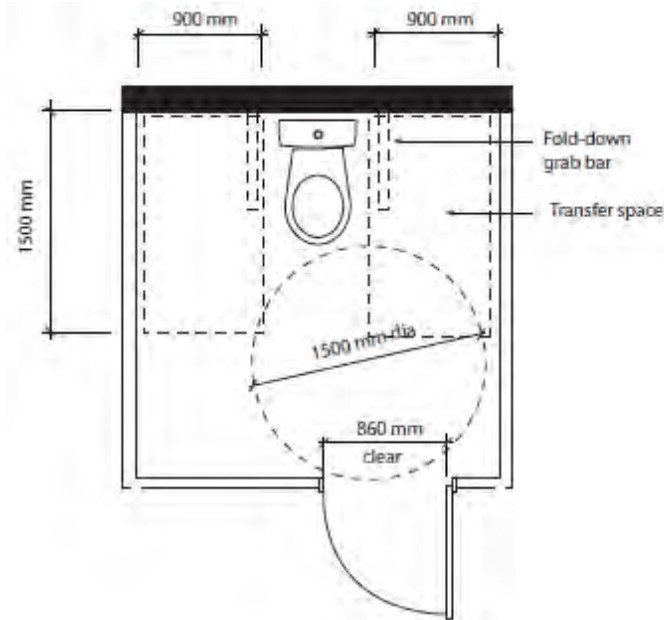


Figure A-3.8.3.8.(2)(b)
Transfer Space on Both Sides of Water Closet

a2.1 A-3.8.3.8.(3) Additional Grab Bars.

Designers may exceed the minimum requirements found in the Building Code and specify the installation of additional grab bars in other locations. These additional grab bars may be of different configurations and can be installed in other orientations.

a3 A-3.8.3.8.(5) L-Shaped Grab Bar.

L-shaped grab bars provide greater support for people who rely on grab bars to assist them in transferring to and from a standing or seated position. Diagonally mounted grab bars may not be suitable for the downward force necessary for support or for pulling upward. Hands can slip along the bar if it is set in a diagonal position. The use of two straight grab bars located at a 90° angle to one another is not permitted.

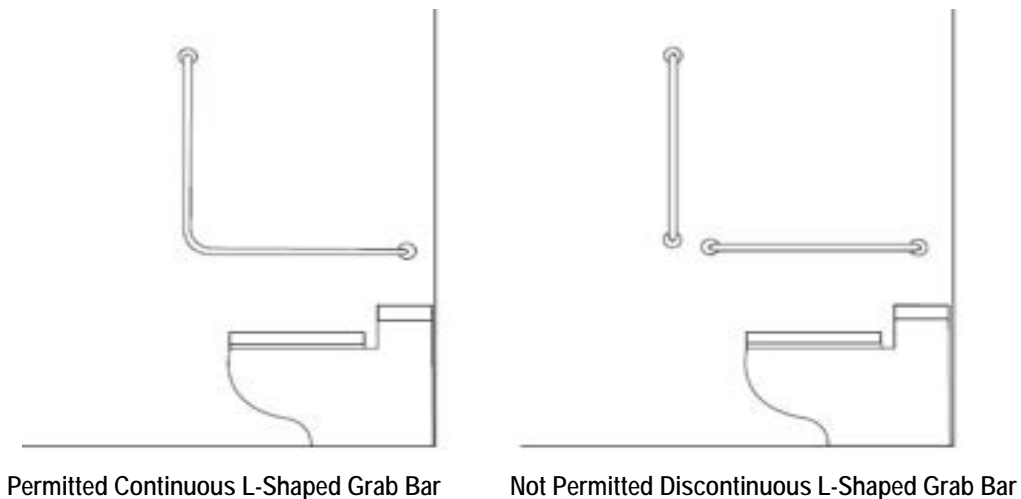


Figure A-3.8.3.8.(5)
L-Shaped Grab Bar

a2.1 A-3.8.3.8.(8) Fold-Down Grab Bars.

A fold-down grab bar is required to resist a load of 1.3 kN applied either vertically or horizontally and will require blocking in the wall so that the grab bar remains anchored to the wall when in use.

a2.1 A-3.8.3.8.(10) Ambulatory Water Closet Stalls.

An ambulatory water closet stall is designed to accommodate people requiring some mobility assistance using aids such as canes or crutches but who do not use wheelchairs. Ambulatory stalls include features such as a higher water closet seat height, grab bars and some additional space for mobility aids such as a cane. A door pull should be provided on both faces of the stall door.

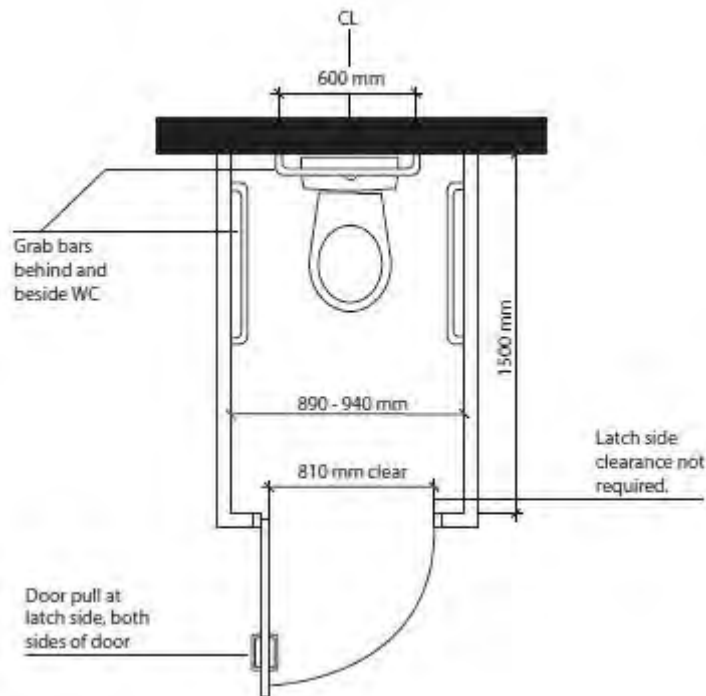


Figure A-3.8.3.8.(10)
Ambulatory Washroom Stall

a3 A-3.8.3.9. Water Closets.

Article 7.2.2.5. applies to water closets referenced in Articles 3.8.3.8., 3.8.3.9. and 3.8.3.12.

A shelf or projection should not be located behind a water closet such that it could present a hazard.

a2.1 A-3.8.3.9.(1)(c) Back Support at Water Closets.

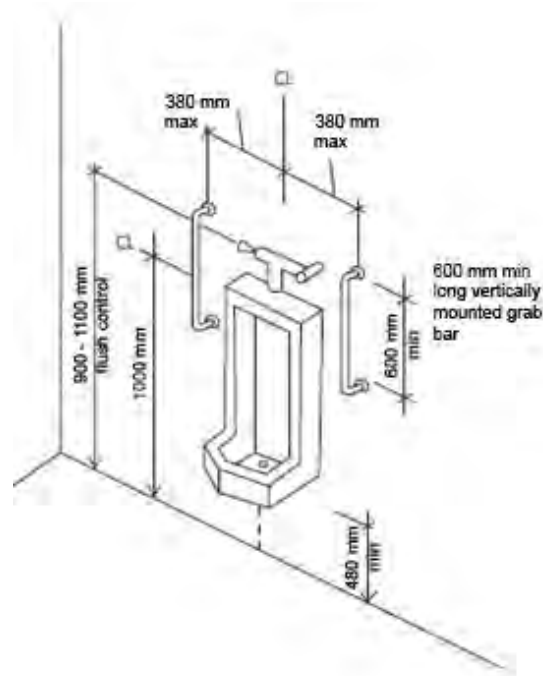
The purpose of the back support is to reduce the chance of imbalance or injury caused by a user leaning against exposed flush valves or pipes. A toilet seat lid, where provided, may be a suitable back support.

A-3.8.3.9.(1) Water Closets.

Wall-mounted water closets or floor models with receding bases are preferable because they provide the least amount of obstruction.

a2.1 A-3.8.3.10. Barrier-Free Urinals.

Where provided, barrier-free urinals require both properly mounted and supported grab bars and privacy screens. Privacy screens alone should not be used as both a privacy and support element.



a11 Figure A-3.8.3.10. Accessible Urinal

a2.1 A-3.8.3.11. Washroom Accessories.

Washroom accessories for barrier-free water closets and lavatories must be located within arm’s reach of a person in a seated position. Placement of towel dispensers and hand dryers should not require that a person seated in a wheelchair must travel beyond the reach range of the lavatory to dry his or her hands.

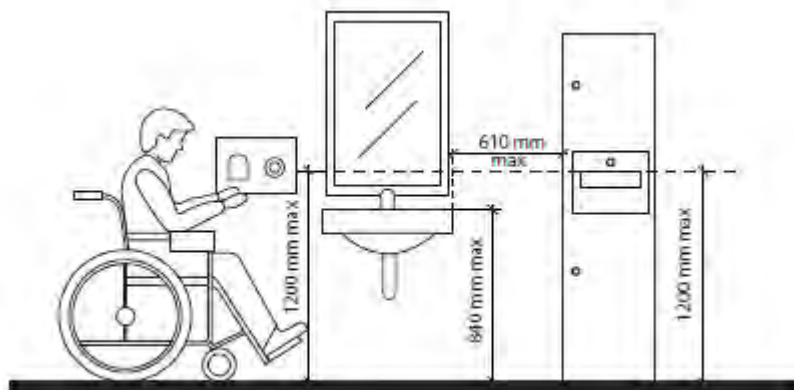


Figure A-3.8.3.11. Washroom Accessories

A-3.8.3.11.(1)(c) Clearances Beneath a Lavatory.

a2.1 Barrier-free lavatories require sufficient knee and toe clearance below to permit a person in a wheelchair to move close enough to the faucet to easily access the water stream.

a3 In order to meet the clearances contained in this Clause, and depending on the lavatory to be installed, it may be necessary to install an offset P.O. lavatory drain.

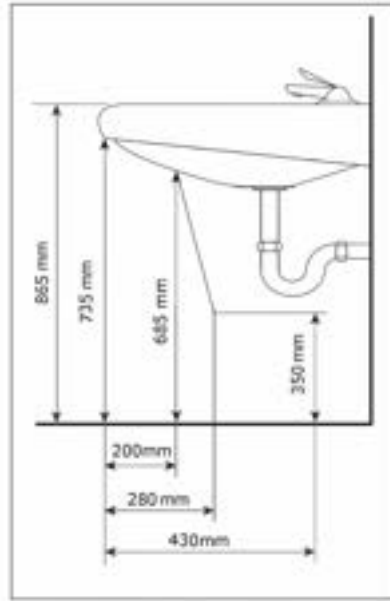


Figure A-3.8.3.11.(1)(c)
Clearances Beneath a Lavatory

a10.1

a2.1 A-3.8.3.11.(1)(d) Pipe Protection.

The pipes referred to in Clause 3.8.3.11.(1)(d) include both supply and waste pipes. The hazard can be prevented by insulating the pipes, by locating the pipes in enclosures, or avoided by limiting the temperature of the hot water to a maximum of 43°C.

a2.1 A-3.8.3.11.(1)(f) Clear Space at Lavatory.

The clear space required for the wheelchair user to pull into the fountain may overlap with an adjacent barrier-free path of travel but should not prevent other building users from passing when the barrier-free lavatory is in use.

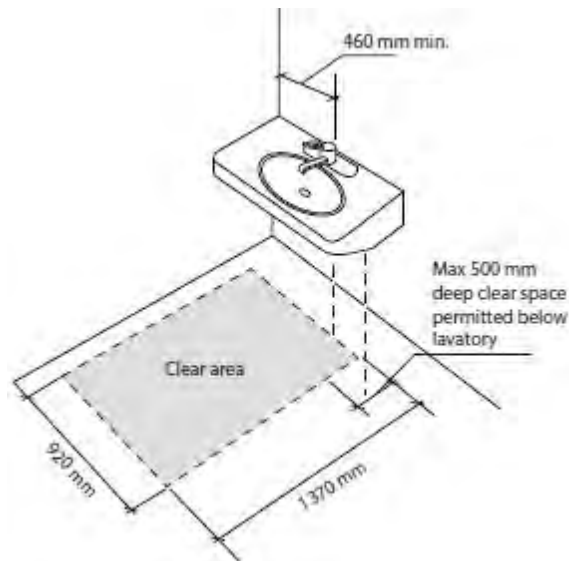


Figure A-3.8.3.11.(1)(f)
Clear Space at Lavatory

a2.1 A-3.8.3.12.(1)(d) Transfer Space.

The transfer space beside a water closet or the approach space at a lavatory must be a clear space with no obstruction or potential obstruction of the space from adjacent elements such as a fold-down change table, or other fixture. The exception to this would be a fold-down grab bar where provided. If a fold down change table is not returned to the folded up position after use, the next user of the space should not be inconvenienced from using the water closet or lavatory due to the transfer or approach spaces being blocked.

a3 A-3.8.3.12.(1) and (3) Universal Washroom.

Unobstructed areas in front of the lavatory, in front of the water closet and on one side of the water closet are necessary for manoeuvrability of a wheelchair. The door swing may overlap the turning circle within the universal washroom as long as there is sufficient space for a wheelchair user to manoeuvre to clear the door and close the door from a front approach position.

The space for an adult size change table may encroach upon the 1700 mm turning circle only where the change table is movable and is not permanently fixed or stored within the washroom. In that case the table, such as a hospital gurney is brought into the washroom when needed and removed after use. A permanently fixed table may not be appropriate for certain building occupancies due to operational and maintenance considerations.

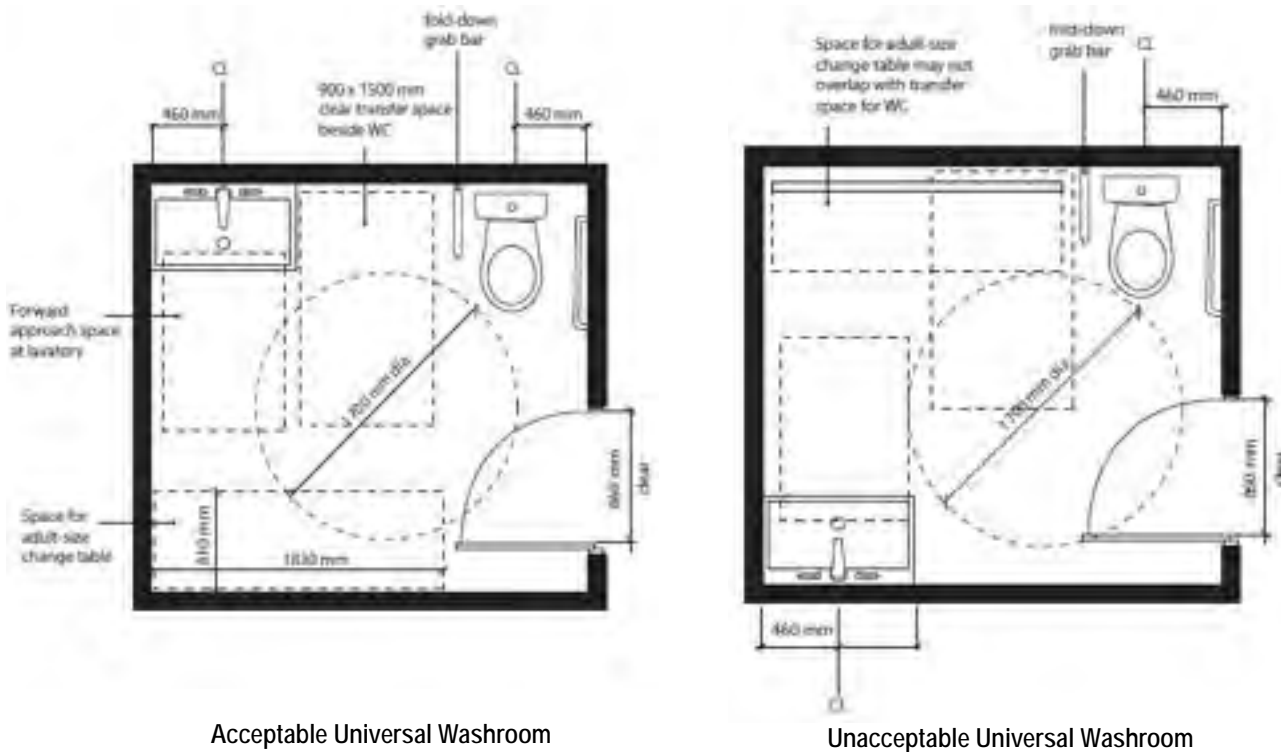


Figure A-3.8.3.12.(1) and (3)
Universal Washroom

a2.1 A-3.8.3.12.(2) Emergency Call System.

The purpose of the emergency call system is to notify other building occupants that a person using the universal washroom requires assistance. The visual signal and alarm should be different from the building fire and smoke alarms and visual signals, where installed, as this call system is for personal, not building, emergencies.

a3 The emergency call button is intended to provide a local visual signal outside of the washroom to alert others that someone in the washroom needs assistance. It is not required to be linked to a central monitoring station. Where central monitoring is not provided, such as in the case of a small building or a standalone washroom in a park, an additional sign informing the washroom users that there is no central monitoring may be appropriate.

a2.1 A-3.8.3.12.(6) Universal Washrooms for Small Buildings.

The permission for a smaller universal washroom to be provided in small buildings recognizes the limited space available for construction of service and amenity spaces while still balancing available space with the needs of people with disabilities.

a2.1 A-3.8.3.13.(1) Minimum Number of Barrier-Free Showers.

The intent of the requirement for one or more barrier-free showers in a group of showers is to address the increased demand for accessible facilities in publicly accessible buildings such as arenas, community recreation centres and private health and fitness facilities where the accessible shower stall is located in the same room as non-accessible showers. It is not the intent of the Code to require single shower stalls or single private use showers that are part of a private office suite to be barrier-free accessible.

A-3.8.3.13.(2)(b) Clear Space at Entrances to Showers.

The clear space at the entrance to a shower may be encroached upon by fixtures such as a wall hung sink which does not interfere with the leg rests of the wheelchair. However, this sink could restrict movement for persons who need to make a lateral transfer if it were installed at the seat end of the shower.

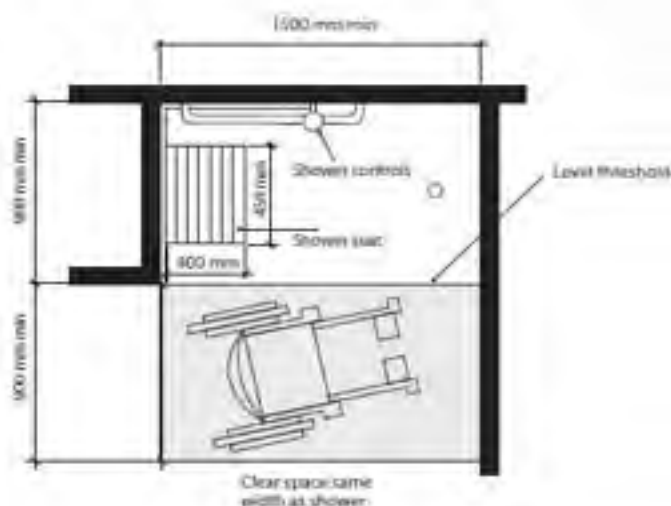


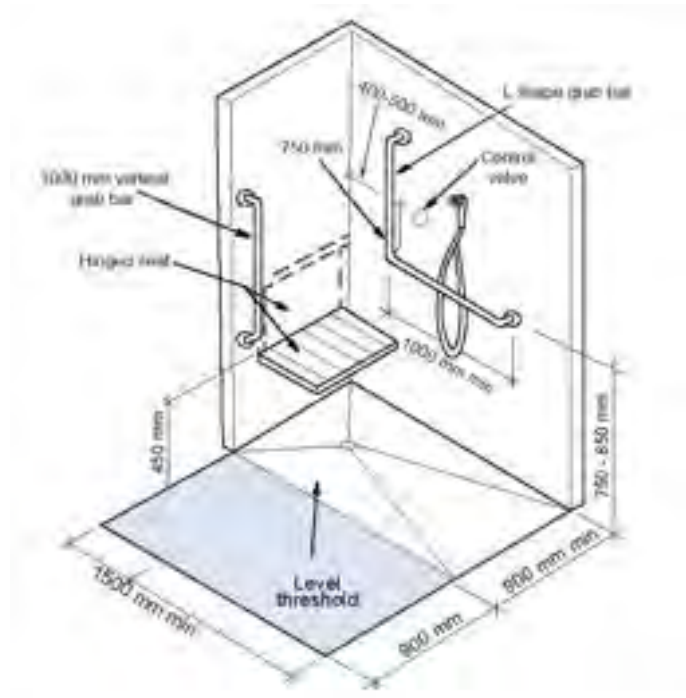
Figure A-3.8.3.13.(2)(b)
Shower Design

a10.1 A-3.8.3.13.(2)(f) and (g) Shower Seat and Grab Bars.

Only one grab bar is required, to be installed on the wall next to the seat; a grab bar behind the seat prevents the user from leaning against the wall, while one located on the wall opposite the seat cannot be reached from the seated position.

The use of two straight grab bars installed at a 90° angle to one another is not acceptable. The Code requires a continuous L-shaped grab bar. The seat itself may be used in conjunction with the bar for transfer. If design flexibility is required, fold away grab bars may be used as an alternative.

a3 A grab bar installed within a barrier-free shower stall on the same wall as the shower controls should have 900 mm long horizontal and vertical components.



a11 Figure A-3.8.3.13.(2)(e), (f) and (g)
Accessible Shower

a2.1 A-3.8.3.13.(4) Showers and Bathtubs.

The grab bars and their mounting position must facilitate getting in and out of the bathtub from a seated or standing position, as appropriate, to limit the need for twisting the body.

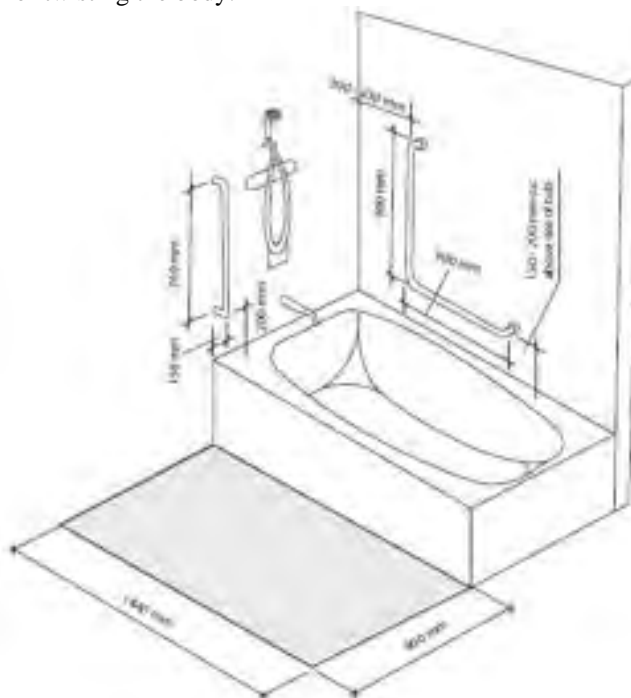


Figure A-3.8.3.13.(4)
Bathtub

a2.1 A-3.8.3.15. Telephone Shelves or Counters.

Built-in shelves or counters for public telephones must be designed to accommodate persons using text telephones (TT). These devices may also be referred to as teletypewriters (TT) or telecommunication devices for the deaf (TDD). These devices require a level surface at least 500 mm wide by 350 mm deep, with no obstruction above that space within 250 mm. If a wall-hung telephone or other obstruction extends to less than 250 mm from the shelf or counter, an equivalent clear space must be provided on either side of each telephone.

At least one telephone should be equipped with a volume control on a receiver that generates a magnetic field compatible with the T-switch of a hearing aid. The lower portion of the shelf or counter is intended for persons using a wheelchair; therefore all parts of the operating mechanism of the telephone above this portion should be within the reach of a wheelchair user.

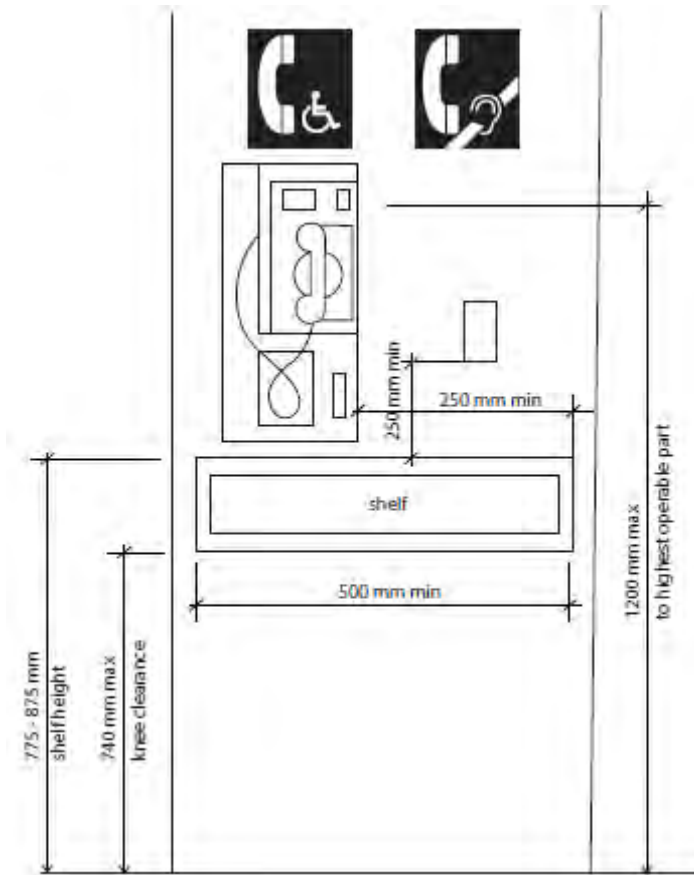


Figure A-3.8.3.15.
Telephone Shelf

a2.1 A-3.8.3.16. Drinking Fountains.

Accessible drinking fountains require sufficient knee and toe clearance below to permit a person in a wheelchair to move close enough to the fountain to easily access the water stream. The 700 mm deep clear space in addition to the fountain depth of 450 mm minimum is required for the wheelchair user to pull into the fountain. That approach space may overlap with an adjacent barrier-free path of travel but should not prevent other building users from passing when the drinking fountain is being used.

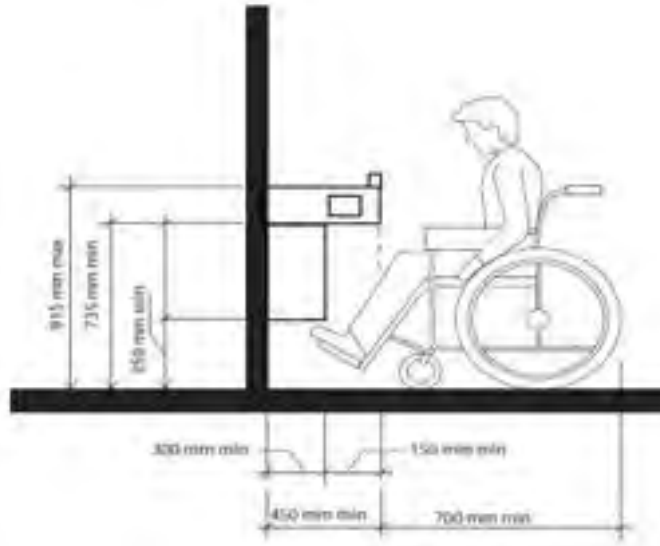
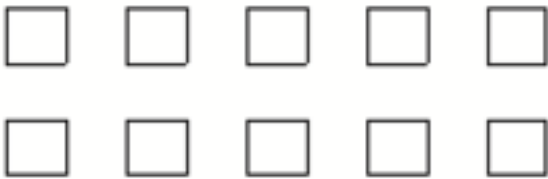


Figure A-3.8.3.16.
Clearances Below Drinking Fountain

A-3.9.3. Portable Classrooms.

Case 1



Distance between classrooms: 6 m or more

3.2.2. applies to each classroom

3.2.3. does not apply between classrooms

Extinguisher required

Access; street; hydrant; fire alarm; - not required

Case 2


Distance between classrooms: less than 6 m

3.2.2. applies to each classroom

3.2.3. applies to each classroom

i.e. rating and construction of facing walls determined by limiting distance

Extinguisher required

Access; street; hydrant; fire alarm; - not required

Case 3


Distance between classrooms: less than 6 m

No. of classrooms in group: 6 max.

Distance between groups: not less than 12 m

3.2.2. applies to each group

3.2.3. does not apply between classrooms within a group if the facing walls have a rating of 45 min, on the inside

3.2.3. applies between groups

Extinguisher required

Access; street; hydrant; fire alarm - not required

Case 4


Distance between classrooms: less than 6 m

No. of classrooms in group: 6 max.

Distance between groups: not less than 12 m

3.2.2. applies to each group

3.2.3. does not apply between classrooms within a group

3.2.3. applies between groups

Extinguisher required

Fire alarm required (extension of main system)

Access; street; hydrant; - not required

Case 5



Distance between classrooms: less than 6 m

No. of classrooms in group: 6 max.

Distance between groups: not less than 12 m

3.2.2. applies to each group

3.2.3. does not apply between classrooms within a group

3.2.3. applies between groups

Extinguisher required

Fire alarm required (extension of main system)

Access; street; hydrant; - not required

All other cases require:

- Fire extinguisher
- Access
- Street
- Hydrant
- Fire alarm: extension of existing system

a2.1 A-3.11.3.1.(9)(a) Barrier-Free Path of Travel at Pool Deck.

The barrier-free path of travel throughout the pool deck area may be included in the 1800 mm wide pool deck space. The width of the barrier-free path of travel must not be reduced where a column or other obstruction interrupts the pool deck space.

a2.1 A-3.11.3.1.(14) Tactile Indicator at Pool Deck.

The tactile indicator at the of the pool deck, signals a warning to people with no or low vision that they have reached the water's edge. The tactile indicator may be built-in or applied but must not present a tripping hazard. The indicator should be a continuous band installed parallel to the outside edge of the gutter around the pool perimeter.

a2.1 A-3.11.3.2.(1) Outdoor Pool Deck.

Where an outdoor pool deck is provided, a barrier-free path that is an exterior walk is required between the building and the outdoor pool, including access from change rooms and showers, and throughout the pool deck area.

a2.1 A-3.11.3.3.(4) Pool Lift Space Requirements.

The clear space required to transfer from a wheelchair to the pool lift may overlap the required barrier-free path of travel within the pool deck.

a3 A-3.11.5.1.(4)(b) Ramps into Public Swimming Pools.

Despite the requirement that the hard surface area piercing the pool deck and leading to a submerged ramp must be at least 750 mm wide, it is recommended that the clear width of the access point to the ramp be at least the same width of the ramp and consistent with Clause 3.8.3.4.(1)(d).

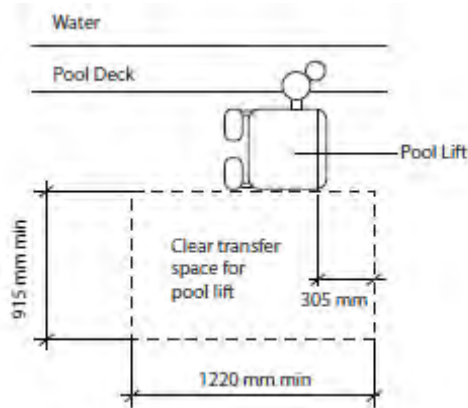


Figure A-3.11.3.3.(4)
Transfer Space at Pool Lift

a2.1 A-3.12.3.2.(3) and (4) Transfer Wall at Public Spa.

A transfer wall design can be accommodated where the spa is raised above the pool deck enabling a wheelchair user to make a horizontal transfer from the wheelchair seat to the top surface of the transfer wall and directly accessing the water on the other side of the wall.

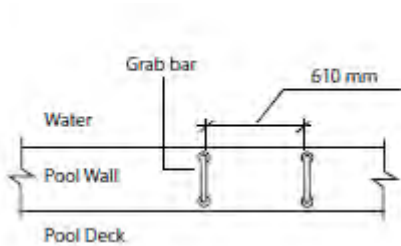


Figure A-3.12.3.2.(3)A
Transfer Wall with Two Grab Bars

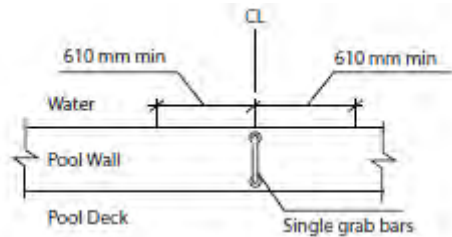


Figure A-3.12.3.2.(3)B
Transfer Wall with One Grab Bar

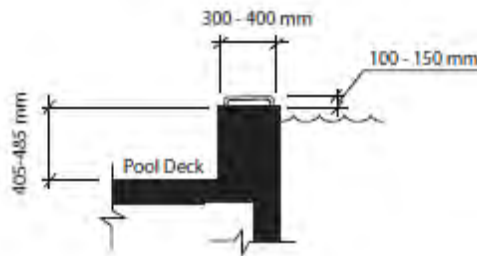


Figure A-3.12.3.2.(3)C
Section at Spa Transfer Wall

A-3.14. Tents and Air-Supported Structures.

The requirements in this Subsection are intended to be limited to certain types of structure. For instance, the word “tent” as used in the Code is intended to refer to a temporary shelter which is used at an open air event such as a fair or an exhibition. A tent will normally be constructed of a fabric held up by poles and attached to the ground by ties. The requirements for tents, however, are not intended to be applied to fabric structures located on buildings.

The term “air-supported structure”, as used in the Code, refers to an envelope which is held up by air pressure alone and which is erected on the ground or on a building. The structure will usually require ballast or a positive anchorage system around the entire perimeter to secure it to the ground or building structure.

A-3.16.1.7.(7) Exits and Means of Egress from Shelf and Rack Storage Systems.

The fundamental principle of providing sufficient exits and means of egress from a shelf and rack storage system is to have the occupants reach an open public thoroughfare, a separate building, or an exterior open space protected from fire exposure from the building and having an access to an open public thoroughfare before the environment in the building becomes life threatening.

In addition to the time-based egress calculation, the professional engineer or architect undertaking the time-based egress analysis, must also undertake a detailed fire dynamics evaluation of the occupancy to determine when critical life threatening levels are reached. Temperature, toxic conditions and psycho-physiological characteristics of the occupants will play an important roll in the analysis.

e7 A-4.1.1.3.(1) Structural Integrity.

The requirements of Part 4, including the CSA design standards, generally provide a satisfactory level of structural integrity. Additional considerations may, however, be required for building systems made of components of different materials, whose interconnection is not covered by existing CSA design standards, buildings outside the scope of existing CSA design standards, and buildings exposed to severe accidental loads such as vehicle impact or explosion. Further guidance can be found in the Commentary entitled “Structural Integrity” in the *2015 Structural Commentaries (User’s Guide – NBC 2015: Part 4 of Division B)*.

e7 A-4.1.1.3.(2) Serviceability.

Information on serviceability can be found in the Commentary entitled “Deflection and Vibration Criteria for Serviceability and Fatigue Limit States” in the *2015 Structural Commentaries (User’s Guide – NBC 2015: Part 4 of Division B)*.

A-4.1.1.4.(2) Structural Equivalents.

Sentence 4.1.1.4.(2) provides for the use of design methods not specified in Part 4, including full-scale testing and model analogues. This provision is usually used to permit the acceptance of newer and innovative structures or to permit the acceptance of model tests such as those used to determine structural behaviour, or snow or wind loads. Sentence 4.1.1.4.(2) specifically requires that the level of safety and performance be at least equivalent to that provided by design to Part 4 and requires that loads and designs conform to Section 4.1.

Sentence 4.1.1.4.(2) and the provision for alternative solutions stated in Clause 1.2.1.1.(1)(b) of Division A are not intended to allow structural design using design standards other than those listed in Part 4. The acceptance of structures that have been designed to other design standards would require the designer to prove to the appropriate authority that the structure provides the level of safety and performance required by Clause 1.2.1.1.(1)(b) of Division A. The equivalence of safety and performance can only be established by analyzing the structure for the loads and load factors set out in Section 4.1. and by demonstrating that the structure at least meets the requirements of the design standards listed in Sections 4.3. and 4.4.

e7 A-4.1.2.1. Loads and Effects.

Information on the definitions can be found in the Commentary entitled “Limit States Design” in the *2015 Structural Commentaries (User’s Guide – NBC 2015: Part 4 of Division B)*.

e7 A-4.1.2.1.(1) Temperature Changes.

Information on effects due to temperature changes can be found in the Commentary entitled “Effects of Deformations in Building Components” in the *2015 Structural Commentaries (User’s Guide – NBC 2015: Part 4 of Division B)*.

A.4.1.2.1.(3) Major Occupancies.

In a building containing more than one major occupancy and classified in more than one Importance Category, the classification of each independent structural system shall be the same as for any part of the building that is dependent on that structural system and for the highest usage group according to Table 4.1.2.1.

A-Table 4.1.2.1.B. Importance Categories for Buildings.

Low Importance Category Buildings

Low human-occupancy farm buildings are defined in the National Farm Building Code of Canada 1995 as having an occupant load of 1 person or less per 40 m² of floor area. Minor storage buildings include only those storage buildings that represent a low direct or indirect hazard to human life in the event of structural failure, either because people are unlikely to be affected by structural failure, or because structural failure causing damage to materials or equipment does not present a direct threat to human life.

Buildings Containing Hazardous Materials

The following buildings contain sufficient quantities of toxic, explosive or other hazardous substances to be classified in the High Importance Category of use and occupancy:

- petrochemical facilities,
- fuel storage facilities (other than those required for post-disaster use), and
- manufacturing or storage facilities for dangerous goods.

The following types of buildings may be classified in the Normal Importance Category: buildings that are equipped with secondary containment of toxic, explosive or other hazardous substances, including but not limited to, double-wall tanks, dikes of sufficient size to contain a spill, or other means to contain a spill or a blast within the property boundary of the facility and prevent the release of harmful quantities of contaminants to the air, soil, groundwater, surface water or atmosphere, as the case may be.

e7 A-4.1.3. Limit States Design.

Information on limit states design can be found in the Commentary entitled “Limit States Design” in the *2015 Structural Commentaries (User’s Guide – NBC 2015: Part 4 of Division B)*.

A-4.1.3.2.(2) Load Combinations.

Load Combination Equations

- e7 The load combinations in Tables 4.1.3.2.A. and 4.1.3.2.B. apply to most situations for loadbearing building structures. Guidance on special situations such as load combinations for fire resistance and building envelopes is given in the Commentary entitled “Limit States Design” in the *2015 Structural Commentaries (User’s Guide – NBC 2015: Part 4 of Division B)*.

Load Cases and Crane Load Effects

The load combinations in Table 4.1.3.2.A. are to be evaluated for structures with crane load effects for the scenario where the crane loads are zero, and for structures without crane loads. The load combinations in Table 4.1.3.2.B. are to be evaluated for structures with crane loads for the scenario where the crane load effects are other than zero.

Crane Loads

- e7 Crane-supporting structures that have cranes in multiple parallel bays should be designed for the maximum vertical crane load with the cranes positioned for the most critical effect in conjunction with a lateral load with each crane in turn positioned for the most critical effect. For load combinations that include crane loads, additional guidance can be found in CISC/ICCA 2013, “Crane-Supporting Steel Structures: Design Guide.”

A-4.1.3.2.(4) Effects of Lateral Earth Pressure, H, Pre-Stress, P, and Imposed Deformation, T, in Design Calculations.

Effects of Lateral Earth Pressure, H, in Design Calculations

- e7 For common building structures below ground level, such as walls, columns and frames, 1.5 H is added to load combinations 2 to 4. For cantilever retaining wall structures, see the Commentary entitled “Limit States Design” in the *2015 Structural Commentaries (User’s Guide – NBC 2015: Part 4 of Division B)*.

Effects of Pre-Stress, P, and Imposed Deformation, T, in Design Calculations

- e7 For structures and building envelopes designed in accordance with the requirements specified in the standards listed in Section 4.3., with the exception of Clauses 8 and 18 of CSA A23.3, P and T need not be included in the load combinations of Table 4.1.3.2. For structures not within the scope of the standards listed in Section 4.3., including building envelopes, P and T must be taken into account in the design calculations. For recommended load combinations including T, see the Commentary entitled “Limit States Design” in the *2015 Structural Commentaries (User’s Guide – NBC 2015: Part 4 of Division B)*.

e7 A-4.1.3.2.(5) Overturning, Uplift or Sliding.

Information on overturning, uplift and sliding can be found in the Commentary entitled “Limit States Design” in the *2015 Structural Commentaries (User’s Guide – NBC 2015: Part 4 of Division B)*.

e7 A-4.1.3.3.(1) Failure Due to Fatigue.

Failure due to fatigue of building structures referred to in Section 4.3. and designed for serviceability in accordance with Article 4.1.3.6. is, in general, unlikely except for girders supporting heavily used cranes, on which Article 4.1.5.11. provides guidance.

e7 A-4.1.3.3.(2) Vibration Effects.

Guidance on vibration effects can be found in the Commentary entitled “Deflection and Vibration Criteria for Serviceability and Fatigue Limit States” in the *2015 Structural Commentaries (User’s Guide – NBC 2015: Part 4 of Division B)*.

e7 A-4.1.3.4.(1) Loads and Load Combinations for Serviceability.

The loads and load combinations for serviceability depend on the serviceability limit states and on the properties of the structural materials. Information on loads and load combinations for the serviceability limit states, other than those controlled by deflection, can be found in the Commentary entitled “Deflection and Vibration Criteria for Serviceability and Fatigue Limit States” in the *2015 Structural Commentaries (User’s Guide – NBC 2015: Part 4 of Division B)*.

e7 A-4.1.3.5.(1) Deflections.

Serviceability criteria for deflections that cause damage to non-structural building components can be found in the standards listed in Section 4.3. Information on deflections can be found in the Commentary entitled “Deflection and Vibration Criteria for Serviceability and Fatigue Limit States” in the *2015 Structural Commentaries (User’s Guide – NBC 2015: Part 4 of Division B)*. Information on loads and load combinations for calculating deflection can be found in the Commentary entitled “Limit States Design” in the *2015 Structural Commentaries (User’s Guide – NBC 2015: Part 4 of Division B)*.

e7 A-4.1.3.5.(3) Lateral Deflection of Buildings.

The limitation of 1/500 drift per storey may be exceeded if it can be established that the drift as calculated will not result in damage to non-structural elements. Information on lateral deflection can be found in the Commentary entitled “Wind Load and Effects” in the *2015 Structural Commentaries (User’s Guide – NBC 2015: Part 4 of Division B)*.

e7 A-4.1.3.6.(1) Floor Vibration.

Information on floor vibration can be found in the Commentary entitled “Deflection and Vibration Criteria for Serviceability and Fatigue Limit States” in the User’s Guide - NBC 2010, Structural Commentaries (Part 4 of Division B). Information on loads and load combinations for the calculation of vibration can be found in the Commentary entitled “Limit States Design” in the *2015 Structural Commentaries (User’s Guide – NBC 2015: Part 4 of Division B)*.

e7 A-4.1.3.6.(2) Dynamic Analyses of Floor Vibrations.

Information on a dynamic analysis of floor vibrations from rhythmic activities can be found in the Commentary entitled “Deflection and Vibration Criteria for Serviceability and Fatigue Limit States” in the *2015 Structural Commentaries (User’s Guide – NBC 2015: Part 4 of Division B)*.

e7 A-4.1.3.6.(3) Lateral Vibration Under Wind Load.

Information on lateral vibrations and accelerations under dynamic wind loads can be found in the Commentary entitled “Wind Load and Effects” in the *2015 Structural Commentaries (User’s Guide – NBC 2015: Part 4 of Division B)*.

A-4.1.4.1.(6) Counteracting Dead Load Due to Soil.

Examples of structures that traditionally employ the dead load of soil to resist loadings are pylon signs, tower structures, retaining walls, and deadmen, which resist wind uplift and overturning in light structures.

A-4.1.5.1.(1) Loads Due to Use of Floors and Roofs.

In many areas of buildings, such as equipment areas, service rooms, factories, storage areas, warehouses, museums, and office filing areas, live loads due to their intended use may exceed the minimum specified loads listed in Table 4.1.5.3. In these instances, the probable live load shall be calculated and used as the specified live load for the design of that particular area.

A-Table 4.1.5.3. Considerations for Live Loads.

Arenas, Grandstands and Stadia

The designer should give special consideration to the effects of vibration.

Attics - Limited Accessibility

Attic live loading is not required when the ceiling below the attic consists of removable panels that permit access to the ceiling space without loading the ceiling supporting members. Attic live loading is not required in any area of the attic where the least dimension of the attic space is less than 500 mm.

Corridors, Aisles and Rows of Seats

The spaces between rows of seats are typically designed for the loads of the occupancy they serve. Rows typically discharge into aisles that are designed for the loads used for the rows of seats. Corridors have a minimum width 1 100 mm and may serve as collectors for aisles; they are therefore part of the exit system and are required to be designed for a minimum live load of 4.8 kPa.

Floor Areas That Could Be Used As Viewing Areas

Some interior balconies, mezzanines, corridors, lobbies and aisles that are not intended to be used by an assembly of people as viewing areas are sometimes used as such; consequently, they are subject to loadings much higher than those for the occupancies they serve. Floor areas that may be subject to such higher loads must, therefore, be designed for a loading of 4.8 kPa.

Lecture Halls and Classrooms

For the purpose of applying the requirements of Table 4.1.5.3., lecture halls with fixed seats are similar to theatres in configuration (the seats may have a writing tablet affixed to one arm). Classrooms are typically furnished with full-sized desks having separate or integrated seats.

Minimum Roof Live Load

Articles 4.1.5.3. and 4.1.5.10. stipulate a minimum uniform roof live load of 1.0 kPa and a minimum concentrated live load of 1.3 kN. These live loads are “use and occupancy loads” intended to provide for maintenance loadings: they are not reduced as a function of area or as a function of the roof slope due to their variability in distribution and location.

Vehicle Loads

A special study should be undertaken to determine the distributed loads to be used for the design of floors and areas used by vehicles exceeding 9 000 kg gross weight and of driveways and sidewalks over areaways and basements. Where appropriate, the designer should refer to CAN/CSA-S6, “Canadian Highway Bridge Design Code”.

A-4.1.5.5. Loads on Exterior Areas.

In Article 4.1.5.5., “accessible” refers to the lack of a physical barrier that prevents or restricts access by vehicles or persons to the site in the context of the specific use.

e7 A-4.1.5.8. Tributary Area.

Information on tributary area can be found in the Commentary entitled “Live Loads” in the *2015 Structural Commentaries (User’s Guide – NBC 2015: Part 4 of Division B)*.

A-Table 4.1.5.9. Loads Due to Concentrations.

Special study is required to determine concentrated loads for the design of floors and areas used by vehicles exceeding 9 000 kg gross weight, and of driveways and sidewalks over areaways and basements. Where appropriate, the designer should refer to CAN/CSA-S6, “Canadian Highway Bridge Design Code”.

A-4.1.5.11. Crane-Supporting Structures.

Guidance on crane-supporting structures can be found in CSA S16, “Design of Steel Structures”.

A.4.1.5.14. and 4.1.5.15.(1) Design of Guards.

In the design of guards, due consideration should be given to the durability of the members and their connections.

e7 A.4.1.5.17. Loads on Firewalls.

Information on loads on firewalls can be found in the Commentary entitled “Structural Integrity of Firewalls” in the *2015 Structural Commentaries (User’s Guide – NBC 2015: Part 4 of Division B)*.

e7 A-4.1.6.2. Coefficients for Snow Loads on Roofs.

Information on coefficients for snow loads on roofs can be found in the Commentary entitled “Snow Loads” in the *2015 Structural Commentaries (User’s Guide – NBC 2015: Part 4 of Division B)*.

a10.1 A-4.1.6.2.(2) Basic Roof Snow Load Factor, C_b .

Figure A-4.1.6.2.(2) shows the basic roof snow load, C_b , plotted against $I_s C_g^2$.

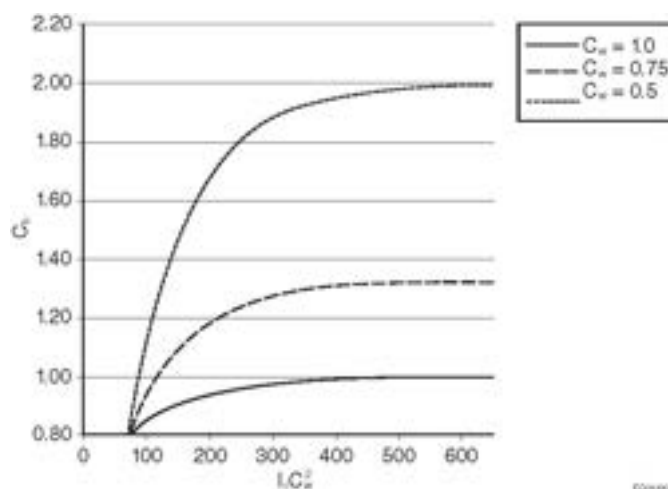


Figure A-4.1.6.2.(2)
Basic Roof Snow Load Factor, C_b

e7 A-4.1.6.3.(2) Full and Partial Loading under Snow Loads.

Information on full and partial snow loading on roofs can be found in the Commentary entitled “Snow Loads” in the *2015 Structural Commentaries (User’s Guide – NBC 2015: Part 4 of Division B)*.

e7 A-4.1.6.4.(1) Rain Loads.

Information on rain loads can be found in the Commentary entitled “Rain Loads” in the *2015 Structural Commentaries (User’s Guide – NBC 2015: Part 4 of Division B)*.

A-4.1.6.4.(3) Flow Control Drains.

Part 7 contains requirements regarding the use of flow control roof drains. The designer must ensure that the building complies with both Part 4 and Part 7.

a10.1 A-4.1.6.7.(1) Roof Projections.

Elevator, air-conditioning and fan housings, small penthouses and wide chimneys are examples of roof projections.

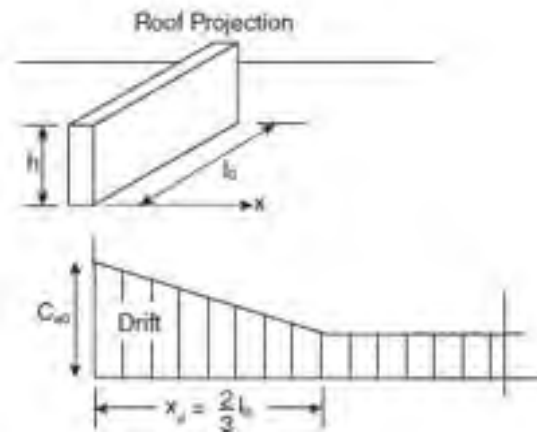


Figure A-4.1.6.7.(1)
Roof Projections

a10.1 A-4.1.6.7.(2) Values of C_a for Small Roof Projections.

Calculating C_a in accordance with Article 4.1.6.5. rather than Sentence 4.1.6.7.(1) results in lower values for small projections.

a10.1 A-4.1.6.9. Load Cases for Gable Roofs.

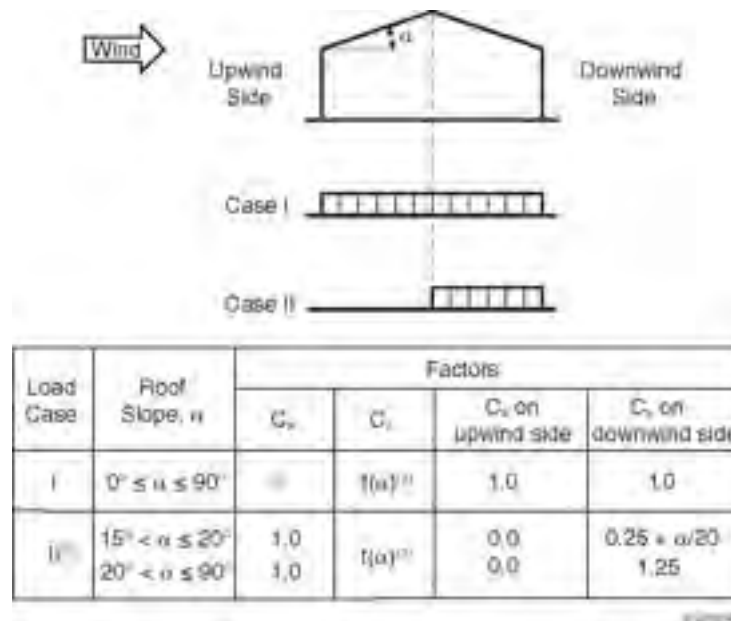


Figure A-4.1.6.9.
Load Cases for Gable Roofs

Notes to Figure A-4.1.6.9.:

- (1) Case II loading does not apply to gable roofs with slopes of 15° or less, to single-sloped (shed) roofs, or to flat roofs.
- (2) The value of C_w for load case I is as prescribed in Sentences 4.1.6.2.(3) and (4).
- (3) Varies as a function of slope, α , as defined in Sentences 4.1.6.2.(5) and (6).

a10.1 A-4.1.7.1.(6) Computational Fluid Dynamics (CFD).

It is not currently possible to verify the reliability and accuracy of CFD and no standards address it; as such, this method is not permitted to be used to determine specified wind loads.

e7 A-4.1.7.2. Natural Frequency.

Information on calculating the natural frequency of a building can be found in the Commentary entitled “Wind Load and Effects” in the 2015 Structural Commentaries (User’s Guide – NBC 2015: Part 4 of Division B).

a10.1 A-4.1.7.3.(5)(c) Procedure for Calculating Intermediate C_e .

Information on calculating intermediate values of C_e between two exposures can be found in the Commentary entitled “Wind Load and Effects” in the 2015 Structural Commentaries (User’s Guide – NBC 2015: Part 4 of Division B).

a10.1 A-4.1.7.3.(10) Internal Gust Factor, C_{qi} .

The effect of building envelope flexibility can be included in the calculation of C_{qi} . See the Commentary entitled “Wind Load and Effects” in the 2015 Structural Commentaries (User’s Guide – NBC 2015: Part 4 of Division B).

a10.1 A-4.1.7.5.(2) and (3) Pressure Coefficients for Main Structural System on Rectangular Buildings.

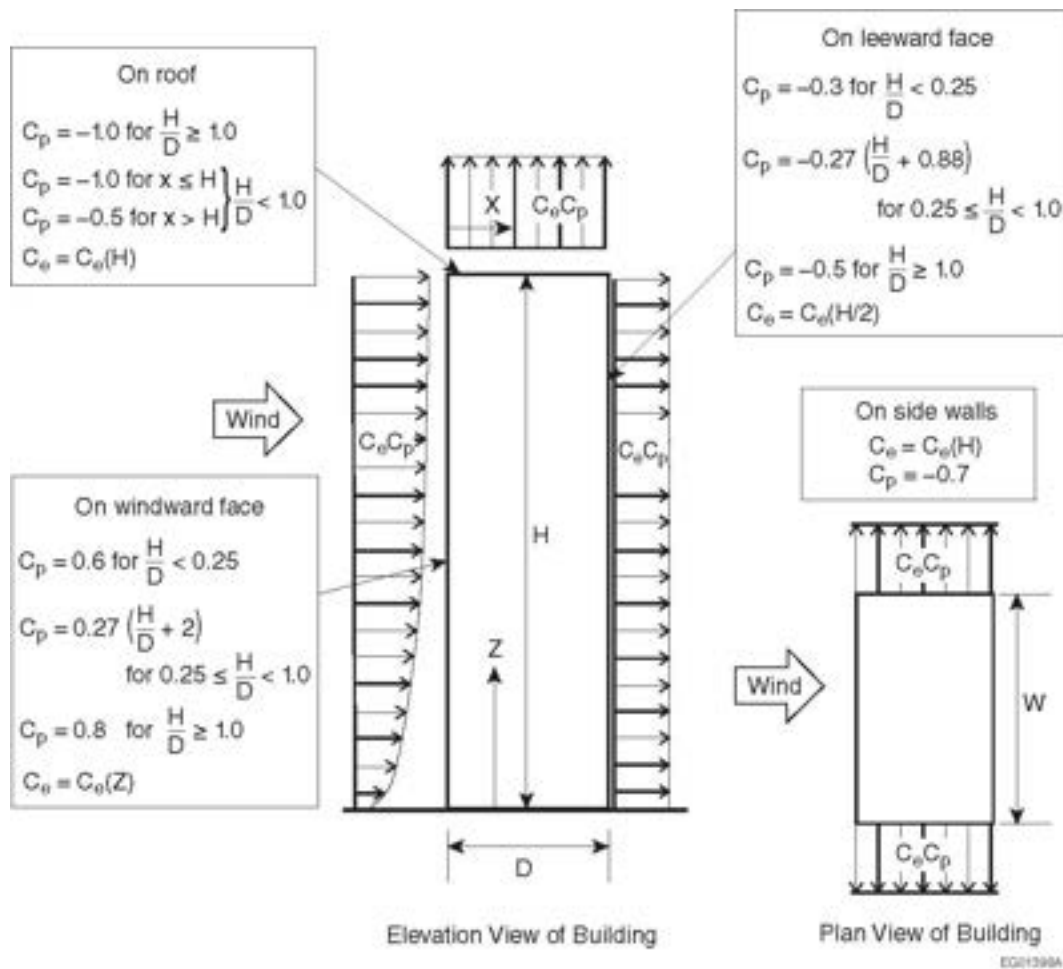


Figure A-4.1.7.5.(2) and (3)
Values of C_p for Main Structural System on Rectangular Buildings

a10.1 A-4.1.7.5.(4) Pressure Coefficients for Roof and Wall Claddings and Secondary Structural Supports of Cladding on Rectangular Buildings.

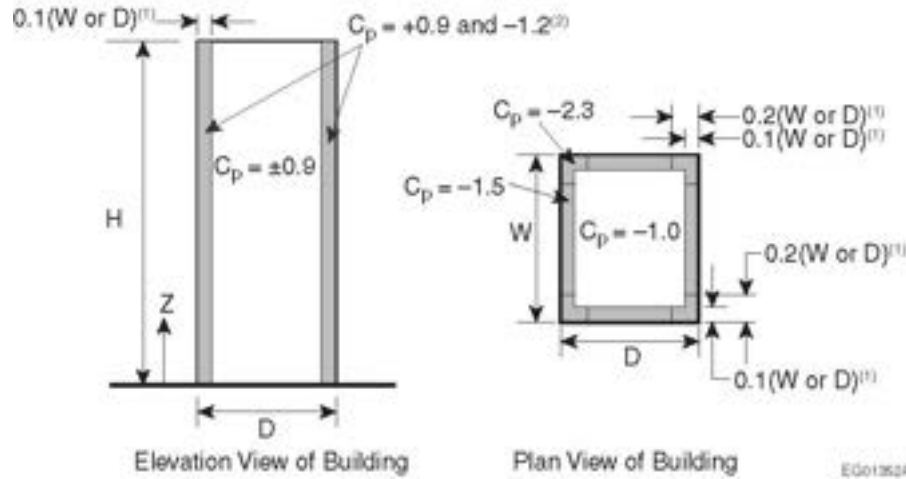


Figure A-4.1.7.5.(4)

Values of C_p for Roof and Wall Claddings and Secondary Structural Supports of Cladding on Rectangular Buildings

Notes to Figure A-4.1.7.5.(4):

- (1) The larger of W or D is to be used.
- (2) Where vertical ribs deeper than 1 m are present on the walls, the dimensions $0.1D$ and $0.1W$ must be changed to $0.2D$ and $0.2W$ and the negative value of C_p must be changed from -1.2 to -1.4 .

a10.1 A-4.1.7.8.(2) and (3) Exposure Factor for Dynamic Procedure.

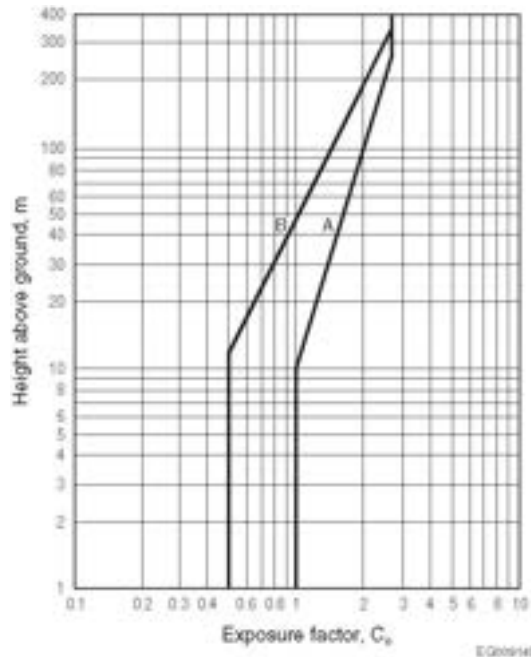


Figure A-4.1.7.8.(2) and (3)
Exposure Factor, C_e , for Dynamic Procedure

Notes to Figure A-4.1.7.8.(2) and (3):

- (1) Curve A represents C_e for open terrain, as defined in Clause 4.1.7.3.(5)(a).
- (2) Curve B represents C_e for rough terrain, as defined in Clause 4.1.7.3.(5)(b).

a10.1 A-4.1.7.8.(4) Peak Factor, Size Reduction Factor and Gust Energy Ratio.

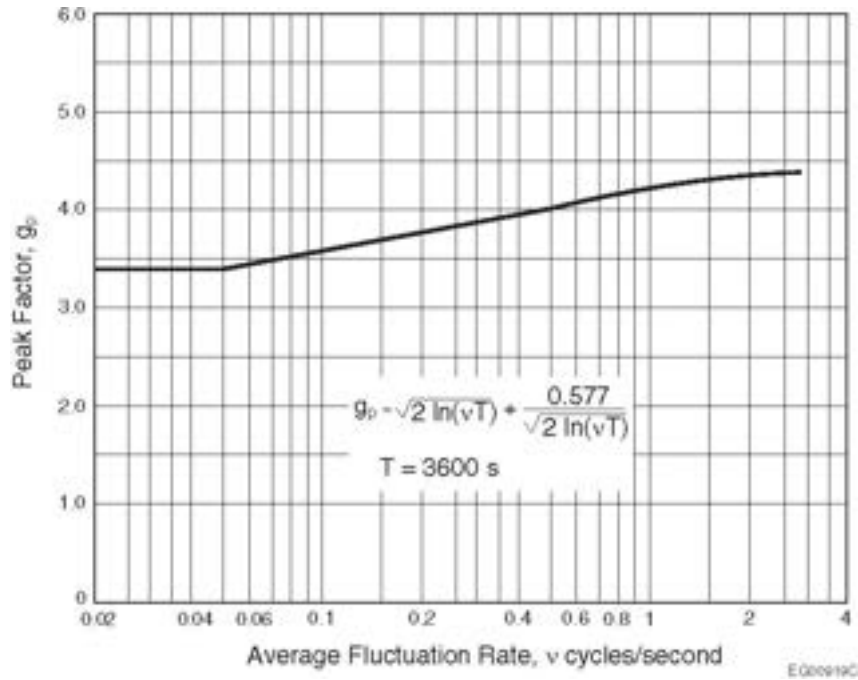


Figure A-4.1.7.8.(4)
Peak Factor, g_p

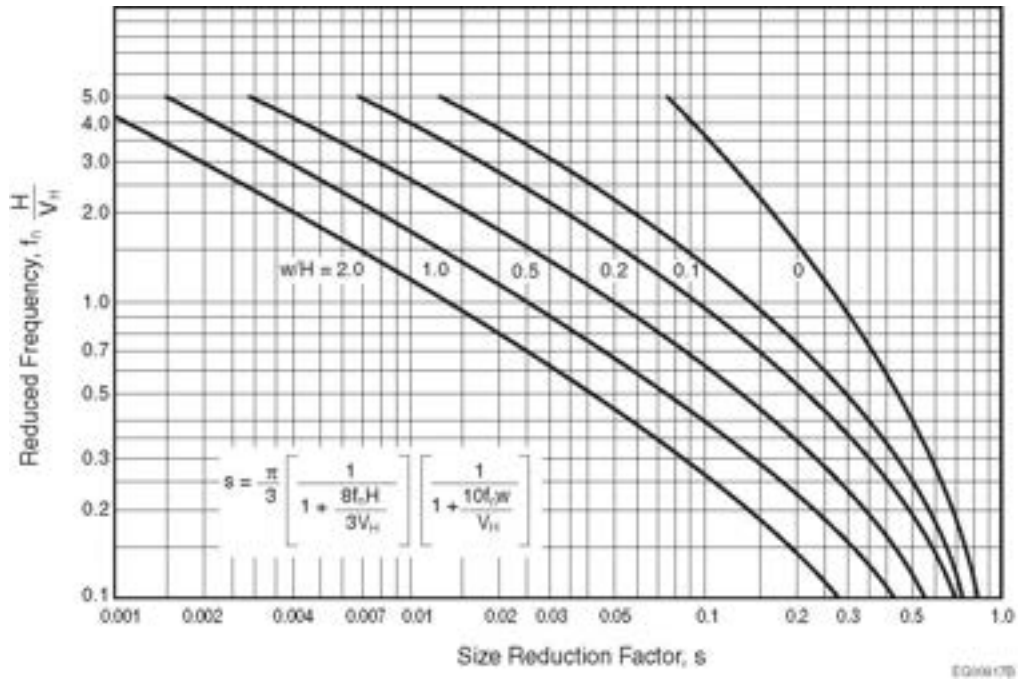


Figure A-4.1.7.8.(4)-B
Size Reduction Factor, s

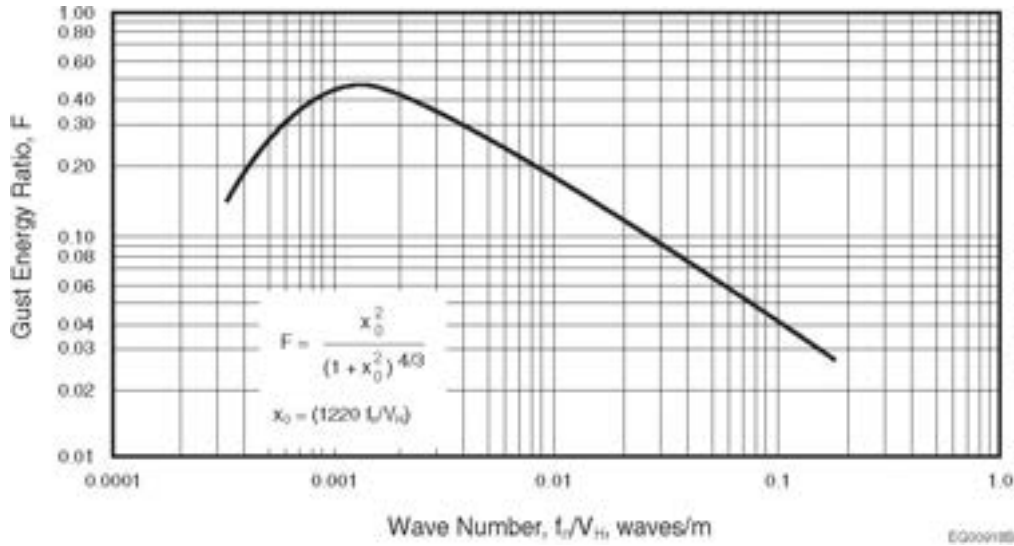


Figure A-4.1.7.8.(4)-C
Gust Energy Ratio, F

a10.1 A-4.1.7.9.(1) Full and Partial Wind Loading.

Information on full and partial loading under wind loads can be found in the Commentary entitled “Wind Load and Effects” in the 2015 Structural Commentaries (User’s Guide – NBC 2015: Part 4 of Division B).

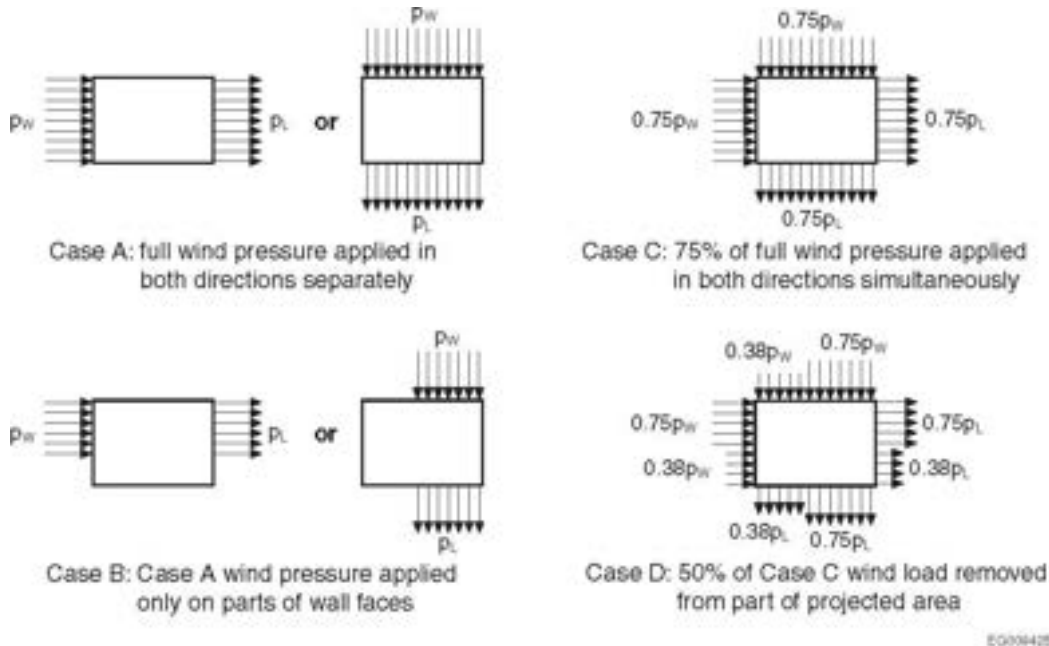


Figure A-4.1.7.9.(1)
Full and Partial Wind Loads

a10.1 A-4.1.7.11. Exterior Ornamentations, Equipment and Appendages.

Appendages may increase the overall forces in the design of the building structure and need to be accounted for.

e7 A-4.1.8.2.(1) Notation.

Definition of e_x

Information on the calculation of torsional moments can be found in the Commentary entitled “Design for Seismic Effects” in the *2015 Structural Commentaries (User’s Guide – NBC 2015: Part 4 of Division B)*.

Definition of W

Information on the definition of dead load, W, can be found in the Commentary entitled “Design for Seismic Effects” in the *2015 Structural Commentaries (User’s Guide – NBC 2015: Part 4 of Division B)*.

e7 A-4.1.8.3.(4) General Design of the SFRS.

Information on the general design requirements for the SFRS can be found in the Commentary entitled “Design for Seismic Effects” in the *2015 Structural Commentaries (User’s Guide – NBC 2015: Part 4 of Division B)*.

e7 A-4.1.8.3.(6) General Design of Stiff Elements.

Information on the general design requirements for stiff elements can be found in the Commentary entitled “Design for Seismic Effects” in the *2015 Structural Commentaries (User’s Guide – NBC 2015: Part 4 of Division B)*.

e7 A-4.1.8.3.(7)(b) and (c) Stiffness Imparted to the Structure from Elements
Not Part of the SFRS.

Information on stiffness imparted to the structure from elements not part of the SFRS can be found in the Commentary entitled “Design for Seismic Effects” in the *2015 Structural Commentaries (User’s Guide – NBC 2015: Part 4 of Division B)*.

e7 A-4.1.8.3.(8) Structural Modelling.

Information on structural modelling can be found in the Commentary entitled “Design for Seismic Effects” in the *2015 Structural Commentaries (User’s Guide – NBC 2015: Part 4 of Division B)*.

e7 A-4.1.8.4.(3) and Table 4.1.8.4.A. Site Class.

Information on Site Class can be found in the Commentary entitled “Design for Seismic Effects” in the *2015 Structural Commentaries (User’s Guide – NBC 2015: Part 4 of Division B)*.

e7 A-Table 4.1.8.5. Serviceability Limit States for Earthquake.

Information on serviceability limit states for earthquake can be found in the Commentary entitled “Design for Seismic Effects” in the *2015 Structural Commentaries (User’s Guide – NBC 2015: Part 4 of Division B)*.

a10.1 A-Table 4.1.8.6. Structural Irregularities.

Information on structural irregularities can be found in the Commentary entitled “Design for Seismic Effects” in the *2015 Structural Commentaries (User’s Guide – NBC 2015: Part 4 of Division B)*.

Gravity-Induced Lateral Demand – Type 9 Irregularity

Uncoupled concrete and masonry shear walls where a large fraction of the overturning resistance is provided by axial compression, rather than through yielding of the longitudinal reinforcement, are less susceptible to amplified displacements due to gravity-induced lateral demands because the axial loads have a self-centering effect on the shear walls. Walls that are stronger than the foundation and other systems such as coupled walls, braced frames and moment frames are more susceptible to amplified displacements due to gravity-induced lateral demands. A lower limit on α is thus specified for such systems. Further information on the impacts of gravity-induced lateral demands on the seismic response of buildings can be found in the Commentary entitled “Design for Seismic Effects” in the *2015 Structural Commentaries (User’s Guide – NBC 2015: Part 4 of Division B)*.

- e7 A-4.1.8.7.(1) Dynamic Analysis Procedures.
Information on dynamic analysis procedures can be found in the Commentary entitled “Design for Seismic Effects” in the *2015 Structural Commentaries (User’s Guide – NBC 2015: Part 4 of Division B)*.
- a10.1 A-Table 4.1.8.9. Industrial-Type Steel Structures.
Guidance on the height limits, system restrictions and additional analysis and design requirements for steel SFRSs in industrial-type structures, intended essentially to support equipment, tanks or an industrial process, can be found in Annex M “Seismic Design of Industrial Steel Structures” of CSA S16, “Design of Steel Structures”.
- e7 A-4.1.8.9.(4) Vertical Variations in R_dR_o .
Information on vertical variations in R_dR_o can be found in the Commentary entitled “Design for Seismic Effects” in the *2015 Structural Commentaries (User’s Guide – NBC 2015: Part 4 of Division B)*.
- e7 A-4.1.8.9.(5) R_dR_o and Equivalent Systems.
Information on the R_dR_o , of equivalent systems can be found in the Commentary entitled “Design for Seismic Effects” in the *2015 Structural Commentaries (User’s Guide – NBC 2015: Part 4 of Division B)*.
- a10.1 A-4.1.8.10.(4) Mid-Rise Timber SFRS.
Information on structural irregularities in mid-rise wood construction and on how to determine the number of storeys for application in Sentence 4.1.8.10.(4) can be found in the Commentary entitled “Design for Seismic Effects” in the *2015 Structural Commentaries (User’s Guide – NBC 2015: Part 4 of Division B)*.
- a10.1 A-4.1.8.10.(5) Gravity-Induced Lateral Demand – Type 9 Irregularity.
Structural systems that include components such as inclined columns or horizontal floor cantilevers can induce lateral force demands on the SFRS under gravity loads. Buildings with such gravity-induced lateral demands on the SFRS are more likely to experience severe damage during strong ground shaking due to their tendency to drift only in one direction, leading to large residual displacements or instability. To determine if a building is susceptible to amplification of displacements due to gravity-induced lateral demands, the lateral resistance of the yielding mechanism to resist earthquake forces alone, Q_y , must be compared with the gravity-induced lateral demand, Q_G , at the same location. The force component selected for this comparison depends on the yielding mechanism for the SFRS. For example, for a coupled wall, the overturning moment resistance at the level of the expected plastic hinges should be compared with overturning moment demand (at the same level) due to gravity loads alone; whereas for a steel braced-frame, the storey shear at the critical level of the yielding system should be compared with the storey shear demand (at the same level) due to the gravity loads alone. If the gravity-induced lateral demands exceed the limits prescribed in Sentence 4.1.8.10.(7), amplifications in seismic displacements due to gravity-induced lateral demands can only be identified through nonlinear dynamic analyses using models which adequately represent the hysteretic behaviour of the SFRS. Further information on the impacts of gravity-induced lateral demands on the seismic response of buildings can be found in the Commentary entitled “Design for Seismic Effects” in the *2015 Structural Commentaries (User’s Guide – NBC 2015: Part 4 of Division B)*.
- a10.1 A-4.1.8.10.(7) Gravity-Induced Lateral Demand – Non-Linear Dynamic Analysis.
Information on non-linear dynamic analysis can be found in the Commentary entitled “Design for Seismic Effects” in the *2015 Structural Commentaries (User’s Guide – NBC 2015: Part 4 of Division B)*.
- e7 A-4.1.8.11.(3) Determination of the Fundamental Period, T_a .
Information on the determination of the fundamental period, T_a , can be found in the Commentary entitled “Design for Seismic Effects” in the *2015 Structural Commentaries (User’s Guide – NBC 2015: Part 4 of Division B)*.
- e7 A-4.1.8.12.(1)(a) Linear Dynamic Analysis.
Information on Linear Dynamic Analysis can be found in the Commentary entitled “Design for Seismic Effects” in the *2015 Structural Commentaries (User’s Guide – NBC 2015: Part 4 of Division B)*.

- e7 A-4.1.8.12.(1)(b) Nonlinear Dynamic Analysis.
Information on Nonlinear Dynamic Analysis can be found in the Commentary entitled “Design for Seismic Effects” in the *2015 Structural Commentaries (User’s Guide – NBC 2015: Part 4 of Division B)*.
- e7 A-4.1.8.12.(3) Ground Motion Histories.
Information on ground motion histories can be found in the Commentary entitled “Design for Seismic Effects” in *2015 Structural Commentaries (User’s Guide – NBC 2015: Part 4 of Division B)*.
- e7 A-4.1.8.12.(4)(a) Accidental Torsional Moments.
Information on accidental torsional moments can be found in the Commentary entitled “Design for Seismic Effects” in the *2015 Structural Commentaries (User’s Guide – NBC 2015: Part 4 of Division B)*.
- e7 A-4.1.8.13.(4) Deflections and Sway Effects.
Information on deflections and sway effects can be found in the Commentary entitled “Design for Seismic Effects” in the *2015 Structural Commentaries (User’s Guide – NBC 2015: Part 4 of Division B)*.
- e7 A-4.1.8.15.(1) Diaphragms and their Connections.
Information on diaphragms and their connections can be found in the Commentary entitled “Design for Seismic Effects” in the *2015 Structural Commentaries (User’s Guide – NBC 2015: Part 4 of Division B)*.
- e7 A-4.1.8.15.(3) Ductile Diaphragms
Information on the design of struts, collectors, chords and connections for ductile diaphragms can be found in the Commentary entitled “Design for Seismic Effects” in the *2015 Structural Commentaries (User’s Guide – NBC 2015: Part 4 of Division B)*.
- a10.1 A-4.1.8.15.(4) Influence of Dynamic Diaphragm In-Plane Response.

Clause 4.1.8.15.(4)(a)

In lieu of carrying out a special study as stated in Subclause 4.1.8.15.(4)(a)(iii), the anticipated total deformation demand on the vertical elements of the SFRS, including inelastic deformations, may be taken as equal to $R_o R_d (\Delta B + \Delta D) - R_o \Delta D$, i.e., the difference between the total storey drift including inelastic deformation effects and diaphragm deformations, $R_o R_d (\Delta B + \Delta D)$, and the diaphragm deformation under R_o times the seismic load, where R_o may be replaced by the actual overstrength of the SFRS vertical elements. The design engineer must verify that the SFRS vertical elements have sufficient deformation capacity to accommodate the computed deformation demand. If the vertical elements of the SFRS do not have sufficient deformation capacity, the design forces for the vertical elements of the SFRS must be magnified by $R_d (1 + \Delta D / \Delta B) / (R_d + \Delta D / \Delta B)$. The calculation of the magnified design forces is iterative as the $\Delta D / \Delta B$ ratio may change when using higher design forces for the vertical elements of the SFRS. Reducing the $\Delta D / \Delta B$ ratio by increasing the stiffness of the roof diaphragm relative to that of the vertical elements of the SFRS may be considered to reduce the deformation demand on the vertical elements of the SFRS. Additional information can be found in the Commentary entitled “Design for Seismic Effects” in the *2015 Structural Commentaries (User’s Guide – NBC 2015: Part 4 of Division B)*.

Clause 4.1.8.15.(4)(b)

The dynamic response of the diaphragm with the vertical elements of the SFRS under seismic excitation involves several modes of vibration that affect both the amplitude and distribution of in-plane shears and bending moments in the roof diaphragm. The shape of the fundamental mode of vibration resembles the deflected shape of the diaphragm/vertical SFRS elements under a distributed lateral load while higher modes involve increasing numbers of zero crossings of the deflected shapes along the length of the diaphragm, similar to the modes of a simply supported beam with distributed mass. Shears and bending moments therefore deviate from the values obtained from the equivalent static force procedure essentially due to higher mode response. Modal contributions to shears and bending moments in the diaphragms can be obtained from a Linear Dynamic Analysis. The contribution from the higher modes is generally more pronounced when the $\Delta D / \Delta B$ ratio, the period in the first mode, or the ratio $S_a(0.2) / S_a(2.0)$ is increased. It also increases when the SFRS is designed with a higher R_d factor as inelastic deformations of the vertical elements of the SFRS attenuate the first mode response. Methods to take into

account the inelastic higher mode effects on in-plane diaphragm shears and moments are discussed in the Commentary entitled “Design for Seismic Effects” in the *2015 Structural Commentaries (User’s Guide – NBC 2015: Part 4 of Division B)*.

e7 A-4.1.8.15.(5) Discontinuities.

Information on elements supporting discontinuities can be found in the Commentary entitled “Design for Seismic Effects” in the *2015 Structural Commentaries (User’s Guide – NBC 2015: Part 4 of Division B)*.

e7 A-4.1.8.15.(6) Vertical Variations in R_dR_o .

Information on elements of the SFRS below the variation in R_dR_o can be found in the Commentary entitled “Design for Seismic Effects” in the *2015 Structural Commentaries (User’s Guide – NBC 2015: Part 4 of Division B)*.

e7 A-4.1.8.15.(7) Concurrent Yielding.

Information on the effects of concurrent yielding of elements can be found in the Commentary entitled “Design for Seismic Effects” in the *2015 Structural Commentaries (User’s Guide – NBC 2015: Part 4 of Division B)*.

e7 A-4.1.8.15.(8) Design Force in Elements.

Information on the design force in elements can be found in the Commentary entitled “Design for Seismic Effects” in the *2015 Structural Commentaries (User’s Guide – NBC 2015: Part 4 of Division B)*.

a10.1 A-4.1.8.16.(1) Foundation Movement.

The bearing stress distribution in soil or rock that is used to determine the factored overturning resistance of the foundation influences the rotation of the foundation, which occurs due to the forces applied by the SFRS. Generally, all foundations will rotate on soil or rock. In particular, footings (a type of foundation unit) often undergo uplift at one end, and if the factored bearing stress at the other end is only over a short length, then the uplift and rotation of the footing can be significant. CSA A23.3, “Design of Concrete Structures”, contains design requirements for footings that rotate and uplift; see also the Commentary entitled “Design for Seismic Effects” in the *2015 Structural Commentaries (User’s Guide – NBC 2015: Part 4 of Division B)* for guidance and methods to account for foundation movement.

a10.1 A-4.1.8.16.(2) Actual Lateral Load Capacity of the SFRS.

The actual lateral load capacity of the SFRS includes the effects of member overstrengths similar to those used to determine the R_o factors. The applicable CSA design standards include requirements on calculating the overstrengths and capacities, which may be based on the members’ nominal or probable resistance. The actual capacities are larger than the factored loads and factored resistances and, in many cases, can be significantly larger. Note that the foundations designed to develop the capacity of the SFRS will undergo movements and Sentence 4.1.8.16.(1) still applies.

a10.1 A-4.1.8.16.(4) Overturning Resistance of the Foundation.

For the special case where the foundation is a footing, and where it and the attached SFRS are not constrained against rotation, it is permitted, with certain limitations, to size the footing to have a factored overturning resistance less than the overturning capacity of the supported SFRS. This approach results in a smaller footing, increased footing rotations, increased drifts in the structure, and increased soil stresses, all of which are over and above those associated with footings sized to have a factored overturning resistance equal to or greater than the overturning capacity of the SFRS. The footing itself must have a factored resistance capable of developing the required soil or rock reactions. An example of a footing and SFRS that are not constrained against rotation is an SFRS on a footing near the ground surface such that it can rotate freely and is attached to a gravity-load-resisting system (non-SFRS) that is laterally flexible and provides little lateral resistance. For this case, the SFRS is usually analyzed on its own and the resulting displacements are imposed on the non-SFRS elements in order to assess the effects on them. Cases where the footing and SFRS are attached to a system that has significant lateral stiffness require careful analysis and engineering judgement, or the footing can be capacity-designed.

Limiting the overturning moment on the foundation and the R_dR_o value provides some control on the increase in lateral displacement, drift and stress in the soil or rock. Cases that exceed these limits require special study.

For the common case where the SFRS and/or the footing are constrained in some way against rotation, the footing's factored resistance must be equal to or greater than the capacity of the supported SFRS. An example of an SFRS constrained against freely rotating with the footing is an SFRS attached to adjacent foundation walls by below-grade diaphragms. Examples of footings constrained against free rotation are footings that use soil anchors to resist overturning, footings on piles, and raft foundations. Note that Sentence 4.1.8.16.(1) still applies.

See CSA A23.3, "Design of Concrete Structures," and the Commentary entitled "Design for Seismic Effects" in the *2015 Structural Commentaries (User's Guide – NBC 2015: Part 4 of Division B)*.

- e7 A-4.1.8.16.(6)(a) Interconnection of Foundation Elements.
Information on the interconnection of piles or pile caps, drilled piers, and caissons can be found in the Commentary entitled "Design for Seismic Effects" in the *2015 Structural Commentaries (User's Guide – NBC 2015: Part 4 of Division B)*.
- e7 A-4.1.8.16.(7) Earthquake Lateral Pressures from Backfill or Natural Ground.
Information on methods of computing the seismic lateral pressures from backfill or natural ground can be found in the Commentary entitled "Design for Seismic Effects" in the *2015 Structural Commentaries (User's Guide – NBC 2015: Part 4 of Division B)*.
- e7 A-4.1.8.16.(8)(a) Cyclic Inelastic Behaviour of Foundation Elements.
Information on the cyclic inelastic behaviour of piles or pile caps, drilled piers, and caissons can be found in the Commentary entitled "Design for Seismic Effects" in the *2015 Structural Commentaries (User's Guide – NBC 2015: Part 4 of Division B)*.
- e7 A-4.1.8.16.(9) Alternative Foundation Ties.
Alternative methods of tying foundations together, such as a properly reinforced floor slab capable of resisting the required tension and compression forces, may be used. Passive soil pressure against buried pile caps may not be used to resist these forces.
- e7 A-4.1.8.16.(10) Liquefaction.
Information on liquefaction can be found in the Commentary entitled "Design for Seismic Effects" in the *User's Guide - 2015 Structural Commentaries (User's Guide – NBC 2015: Part 4 of Division B)*.
- e7 A-4.1.8.17.(1) Slope Stability.
Information on slope stability can be found in the Commentary entitled "Design for Seismic Effects" in the *2015 Structural Commentaries (User's Guide – NBC 2015: Part 4 of Division B)*.
- e7 A-4.1.8.18. Elements of Structures, Non-Structural Components and Equipment.
Information on the requirements of Article 4.1.8.18. can be found in the Commentary entitled "Design for Seismic Effects" in the *2015 Structural Commentaries (User's Guide – NBC 2015: Part 4 of Division B)*.
- a10.1 A-Table 4.1.8.18. Non-Structural Components and Equipment.
The failure or detachment of non-structural components and equipment during an earthquake can present a major threat to life safety. The design requirements presented in Article 4.1.8.18. are intended to ensure that such components and their connections to the building will retain their integrity during strong ground shaking. Guidelines for the seismic risk reduction of such components are given in CSA S832, "Seismic Risk Reduction of Operational and Functional Components (OFCs) of Buildings".
- a10.1 A-4.1.8.18.(13) Storage Racks.
Free-standing steel pallet storage racks contain only materials typically loaded by forklift. They are designed to store loaded pallets, however in some cases, the stored material does not sit on a pallet. There is no occupancy within the racks. Information on racks can be found in the Commentary entitled "Design for Seismic Effects" in the *2015 Structural Commentaries (User's Guide – NBC 2015: Part 4 of Division B)*.

a10.1 A-4.1.8.18.(14) and (15) Glass Fallout and Failure.

Information on glass fallout and testing for glass fallout can be found in AAMA 501.6, “Recommended Dynamic Test Method For Determining The Seismic Drift Causing Glass Fallout From A Wall System”. Every surface other than inaccessible areas or areas where occupancy is prevented or access is prevented should be considered a “walking surface”. Additional information can be found in ASCE/SEI 7, “Minimum Design Loads for Buildings and Other Structures”, in FEMA P-750, “NEHRP Recommended Seismic Provisions for New Buildings and Other Structures”, and FEMA 450-1, “NEHRP Recommended Provisions for Seismic Regulations for New Buildings and Other Structures”, and related commentaries, and in the Commentary entitled “Design for Seismic Effects” in the *2015 Structural Commentaries (User’s Guide – NBC 2015: Part 4 of Division B)*.

a10.1 A-4.1.8.19.(2) Design Review.

It is strongly recommended that a design review of the seismically isolated structure and its isolation system be carried out by an independent team of professional engineers and geoscientists experienced in seismic analysis methods and the theory and application of seismic isolation. The design review should include, but not be limited to, the following:

- (a) site-specific spectra,
- (b) ground motion time histories,
- (c) modeling and analyses,
- (d) testing program and results, and
- (e) final design of all structural framing elements and isolation system components.

a10.1 A-4.1.8.19.(3)(a) Non-Linear Dynamic Analysis.

Three-dimensional non-linear dynamic analysis is a complex process requiring special expertise. Guidance on non-linear dynamic analysis can be found in the Commentary entitled “Design for Seismic Effects” in the *2015 Structural Commentaries (User’s Guide – NBC 2015: Part 4 of Division B)*.

a10.1 A-4.1.8.19.(4) and A-4.1.8.21.(5) Ground Motion Time Histories.

Ground motion time histories and the horizontal and vertical components shall be appropriately selected and scaled according to accepted practice. Further information on ground motion time histories can be found in the Commentary entitled “Design for Seismic Effects” in the *2015 Structural Commentaries (User’s Guide – NBC 2015: Part 4 of Division B)*.

a10.1 A-4.1.8.21.(2) Design Review.

It is strongly recommended that a design review of the structure and the supplementary energy dissipation system be carried out by an independent team of professional engineers and geoscientists experienced in seismic analysis methods and the theory and application of supplementary energy dissipation. The design review should include, but not be limited to, the following:

- (a) ground motion time histories,
- (b) modeling and analyses,
- (c) testing program and results, and
- (d) final design of all structural framing elements and supplemental energy dissipation system components.

a10.1 A-4.1.8.21.(4)(a) Non-Linear Dynamic Analysis.

Three-dimensional non-linear dynamic analysis is a complex process requiring special expertise. Guidance on non-linear dynamic analysis can be found in the Commentary entitled “Design for Seismic Effects” in the *2015 Structural Commentaries (User’s Guide – NBC 2015: Part 4 of Division B)*.

A-4.2.2.1.(1) Subsurface Investigation.

Where acceptable information on subsurface conditions already exists, the investigation may not require further physical subsurface exploration or testing.

A-4.2.4.1.(1) Innovative Designs.

It is important that innovative approaches to foundation design be carried out by a person especially qualified in the specific method applied and that the design provide a level of safety and performance at least equivalent to that provided for or implicit in the design carried out by the methods referred to in Part 4. Provision must be made for monitoring the subsequent performance of such structures so that the long-term sufficiency of the design can be evaluated.

e7 A-4.2.4.1.(3) Ultimate Limit States for Foundations.

Information on ultimate limit states for foundations, including terminology and resistance factors, can be found in the Commentary entitled “Foundations” in the *2015 Structural Commentaries (User’s Guide – NBC 2015: Part 4 of Division B)*.

e7 A-4.2.4.1.(5) Design of Foundations for Differential Movements.

Information on the design of foundations for differential movements can be found in the Commentary entitled “Foundations” in the *2015 Structural Commentaries (User’s Guide – NBC 2015: Part 4 of Division B)*.

A-4.2.4.4.(1) Depth of Foundations.

When adfreeze has occurred and subsequent freezing results in soil expansion beneath this area, the resulting uplift effect is sometimes referred to as frost jacking.

A heated building that is insulated to prevent heat loss through the foundation walls should be considered as an unheated structure unless the effect of the insulation is taken into account in determining the maximum depth of frost penetration.

e7 A-4.2.5.1.(1) Excavations.

Information on excavations can be found in the Commentary entitled “Foundations” in the *2015 Structural Commentaries (User’s Guide – NBC 2015: Part 4 of Division B)*.

e7 A-4.2.6.1.(1) Shallow Foundations.

Information on shallow foundations can be found in the Commentary entitled “Foundations” in the *2015 Structural Commentaries (User’s Guide – NBC 2015: Part 4 of Division B)*.

A-4.2.7.1.(1) Deep Foundation Units.

A deep foundation unit can be pre-manufactured or cast-in-place; it can be driven, jacked, jetted, screwed, bored or excavated; it can be of wood, concrete or steel or a combination thereof.

e7 A-4.2.7.2.(1) Deep Foundations.

Information on deep foundations can be found in the Commentary entitled “Foundations” in the *2015 Structural Commentaries (User’s Guide – NBC 2015: Part 4 of Division B)*.

A-4.2.7.2.(2) Load Testing of Piles.

ASTM D1143, “Piles Under Static Axial Compressive Load”, defines routine load test procedures that have been extensively used.

A-4.3.3.1.(1) Precast Concrete.

CAN/CSA-A23.3, “Design of Concrete Structures”, requires precast concrete members to conform to CSA A23.4, “Precast Concrete - Materials and Construction”.

A-4.3.4.1.(1) Welded Construction.

Qualification for fabricators and erectors of welded construction is found in Clause 24.3 of CSA S16, “Design of Steel Structures”.

A-4.3.4.2.(1) Cold-Formed Stainless Steel Members.

There is currently no Canadian standard for the design of cold-formed stainless steel structural members. As an interim measure, design may be carried out using the limit states design provisions of ASCE/SEI 8, “Design of Cold Formed Stainless Steel Structural Members”, except that load factors, load combinations and load combination factors shall be in accordance with Subsection 4.1.3.

A-4.3.4.3.(1) Steel Building Systems.

A steel building system is defined in Section 3 of CAN/CSA-A660, “Certification of Manufacturers of Steel Building Systems”.

a10.1 A-4.3.6.1.(1) Design Basis for Glass.

The load factors in Tables 4.1.3.2.A. and 4.1.3.2.B. must be applied to the adjusted wind load before designing in accordance with the referenced standard. Additional information is given in the Commentary entitled “Wind Load and Effects” in the *2015 Structural Commentaries (User’s Guide – NBC 2015: Part 4 of Division B)*.

a10.1 A-4.4.2.1.(1) Design Basis for Storage Garages and Repair Garages.

es See the Commentary entitled “Live Loads” in the *2015 Structural Commentaries (User’s Guide – NBC 2015: Part 4 of Division B)*.

A-5 Environmental Separation.

The requirements provided in Part 5 pertain to the separation of environmentally dissimilar spaces. Most obvious is the need to separate indoor conditioned spaces from unconditioned spaces, the outdoors or the ground. There are also cases where separation is needed between interior spaces which are intended to provide different environments. (See also Appendix Notes A-5.1.1.1.(1) and A-5.1.2.1.(1).)

A-5.1.1.1.(1) Scope.

Part 5 provides explicit requirements related to the transfer of heat, air, moisture and sound in various forms. Control of the ingress of radon and other soil gases is addressed by the requirements related to air leakage.

A-5.1.2.1.(1) Application.

Subsection 1.1.2. of Division A specifies that Part 5 applies to all buildings except those within the scope of Part 9 or the scope of the National Farm Building Code of Canada. Because of their intended use, many buildings need only provide a limited degree of separation from the outdoor environment, the ground, or between interior spaces. The provisions in Part 5 are written to allow exemptions for these buildings.

Part 5 applies to building elements that separate dissimilar environments and to site conditions that may affect environmental loading on the building envelope.

The provisions address

- the design and construction, or selection, of building components, such as windows and doors,
- the design and construction of building assemblies, such as walls, floors and roofs,
- the design and construction of the interfaces between the above-mentioned elements, and
- the design or selection, and installation, of site materials, components and assemblies, such as backfill and drainage, and grading.

Part 5 applies not only to building elements that separate indoor space from outdoor space, but also to those elements that separate indoor space from the ground and that separate adjacent indoor spaces having significantly different environments. Indoor spaces that require separation include interior conditioned spaces adjacent to indoor unconditioned spaces, and adjacent interior conditioned spaces that are intended to provide different environments. An extreme example of the last would be a wall that separates an indoor ice rink from a swimming pool.

Some building elements are exposed to exterior environmental loads but do not separate dissimilar environments. Solid guards on exterior walkways are one example. Such elements are subject to the application of Part 5.

A-5.1.4.1. Application of Structural Design to Other Building Elements.

Part 4, as currently written, applies primarily to buildings as a whole and to structural members. Requirements defining structural loads and design to accommodate or resist those loads, however, apply not only to buildings as a whole and components that are traditionally recognized as structural members, but also apply to other elements of the building that are subject to structural loading. This is addressed to some extent in Part 4 by the requirements that pertain, for example, to wind loads on cladding. A range of structural loads and effects, as defined in Subsection 4.1.2., may be imposed on non-loadbearing elements such as backing walls, roofing, interior partitions and their connections. These must generally be addressed using the same load determination and structural design procedures as used for structural members.

Responsibility for the structural design of buildings as a whole and their structural members is commonly assigned to the designer of record. The application of Part 4 reflects this, and as such, “non-structural” elements are not explicitly identified in the Part 4 provisions. Rather, the application of Part 4 to these elements is specified in cross-references from other Parts of the Code, e.g. Part 5, which recognizes the fact that the structural design of these elements is often carried out by designers other than the designer of record.

^{e7} Part 4 applies to the design of the connections of building services to address earthquake loads (See Article 4.1.8.18.).

a10.1 A-5.1.4.1.(1.1) Materials, Components and Assemblies with Multiple Functions.

Where materials, components or assemblies are used to fulfill multiple functions, the designer may have to take into account their function with regard to structural loads, heat transfer, air leakage, vapour diffusion, and protection from precipitation, surface and ground water, and sound transmission. Materials should be selected taking into account the environmental loads to which they will be subjected, their physical and chemical characteristics, and their installation. Design and construction details should satisfy all intended functions and ensure continuity within and between assemblies, without adversely impacting adjacent materials, components or assemblies. The designer should also anticipate unintended consequences when materials that may fulfill multiple functions are used. For example, building membranes consisting of modified bitumen compounds, which are commonly used to control both water ingress and air leakage, also typically have low vapour transmission characteristics. Similarly, extruded polystyrene boards, which are used as thermal insulation, may also act as a component of an air barrier assembly, thus requiring wind loads to be considered.

An increasing number of manufactured systems are being used to serve more than one (and sometimes all) of the functions of an environmental separator: examples include pre-engineered building systems, exterior insulation finish systems, insulated metal panel systems, windows, other fenestration assemblies, and insulated precast concrete wall panels. These systems consist of combinations of pre-manufactured and/or site-built components, which are supposed to be assembled in a prescribed manner.

Ensuring compliance with one Section of Part 5 may impact compliance with other Sections of Part 5: for example, air barriers that are integral to some systems may also act as vapour barriers and impact condensation control. By extension, ensuring compliance with the requirements of Part 5 may impact compliance with other Parts of the Building Code: for example, increasing the thickness of the insulation to improve an assembly’s thermal performance may impact its compliance with Part 3 with regard to fire resistance.

Compliance with a standard listed in Section 5.10. does not ensure that a system is appropriate for the intended application. The designer should consider all relevant criteria, beyond the standard tests, when selecting an appropriate product for a project.

A-5.1.4.1.(4) Past Performance as Basis for Compliance with Respect to Structural Loads.

As discussed in Appendix Note A-5.1.4.1., a range of structural loads and effects can be imposed on materials, components and assemblies in environmental separators and assemblies exposed to the exterior. In many instances, compliance with Sentence 5.1.4.1.(1) for structural loads must be determined based on the loads and calculation methods described in Part 4 as specified in Sentence 5.1.4.1.(2) and the referenced Subsection 5.2.2., e.g. for cladding. In practice, compliance for some materials, components or assemblies of environmental separators and assemblies exposed to the exterior is determined by relying on provisions governing the use of alternative solutions (such as Clause 1.2.1.1.(1)(b) of Division A).

For some very common building elements and installations, however, there is a very large body of evidence of proven performance over a long period of time. In these cases, imposing the degree of analysis, or documentation of performance, required by Part 4 or Section 2.1. of Division C would be unnecessary and onerous. Clause 5.1.4.1.(4)(b) is intended to address these particular cases. Because these common building elements and assemblies are so widely accepted throughout the industry and the body of evidence is so substantial (though not necessarily documented in an organized fashion), detailed analysis or documentation is unnecessary.

Whether compliance of a particular material, component or assembly may be determined based on past performance depends not only on the type of material, component or assembly, but also on its intended function, the particular loads to which it will be subject and the magnitude of those loads. Because the possible number of combinations and permutations is astronomical, only guidelines can be provided as to when past performance is a reasonable basis for determining compliance.

In determining compliance based on past performance, the period of past performance considered should be a substantial number of years. For example, 30 years is often used to do life-cycle cost analysis of the viability of investments in building improvements. This period is more than long enough for most deficiencies to show up. There should be no question as to the structural adequacy of a material, component or assembly that has been successfully used in a given application for such a period.

The determination of compliance may be based on past performance only where the function of the material, component or assembly is identical to that of the materials, components or assemblies used as a reference, and where the expected loads do not exceed those imposed on the reference materials, components or assemblies. For example, the acceptance of gypsum board, and its fastening, to serve as part of the backing wall supporting cladding cannot be based on the performance of gypsum board that has served only as an interior finish.

The determination of compliance may be based on past performance only where the properties of the material, component or assembly are identical or superior to those of the materials, components or assemblies used as a reference. For example, where a component of a certain gauge of a particular metal has provided acceptable performance, the same component made of the same metal or a stronger one would be acceptable.

Compliance with respect to various loads may be determined individually. A particular material may have to be designed to Part 4 to establish acceptable resistance to wind or earthquake loads, for example, but past performance may be adequate to determine that the material and normal fastening will support the material's dead load and will resist loads imposed by thermal and moisture-related expansion and contraction.

Past performance is a reasonable basis for determining compliance for lighter materials, components or assemblies not subject to wind load; for example, semi-rigid thermal insulation installed in wall assemblies where other materials, components or assemblies are installed to resist air pressure loads.

Past performance is an appropriate basis for determining compliance for some smaller elements that will be subject to wind loads but are continually supported or fastened behind elements that are designed for wind loads, for example, standard flashing over wall penetrations.

It should be noted that this particular approach to demonstrating compliance pertains only to the resistance or accommodation of structural loads described in Part 4. The resistance or accommodation of environmental loads, resistance to deterioration, and material compatibility must still be addressed in accordance with Part 5.

a10.1 A.5.1.4.1.(5)(b) and (c) Accommodating Movement.

It is well understood that the deflection of the backing assembly in a wall can have significant effects on the performance of the cladding. For example, CSA S304, “Design of Masonry Structures”, specifies the maximum deflection criteria for backing assemblies to masonry veneer. Clauses 5.1.4.1.(5)(b) and (c) are written in very general terms in recognition of the fact that not only can the deflection of cladding affect the performance of the backing assembly, but that the excessive deflection of any element has the potential to adversely affect the performance of any adjacent element. Similarly, inter-storey drift has the potential to adversely affect the performance of components and assemblies of environmental separators. CSA O86, “Engineering Design in Wood”, specifies a method for calculating building movement due to changes in moisture content. The effects of movement should be avoided or accommodated.

a10.1 A-5.1.4.2. Deterioration.

Environmental loads that must be considered include but are not limited to: sound, light and other types of radiation, temperature, moisture, air pressure, acids and alkalis.

Mechanisms of deterioration include:

- structural (impact, air pressure)
- hygrothermal (freeze-thaw, differential movement due to thermal expansion and contraction, ice lensing)
- electrochemical (oxidation, electrolytic action, galvanic action, solar deterioration)
- biochemical (biological attack, intrusion by insects and rodents).

Information on the effects of deformations in building elements can be found in the Commentary entitled “Effects of Deformations in Building Components” in the *2015 Structural Commentaries (User’s Guide – NBC 2015: Part 4 of Division B)*.

Resistance to deterioration may be determined based on field performance, accelerated testing or compliance with guidelines provided by evaluation agencies recognized by the authority having jurisdiction. Guidance can be found in CSA S478, “Guideline on Durability in Buildings”.

Building components should be designed with some understanding of the length of time over which they will effectively perform their intended function. Actual service life will depend on the materials used and the environment to which they are exposed. The design should take into consideration these factors, the particular function of the component and the implications of premature failure, the ease of access for maintenance, repair or replacement, and the cost of repair or replacement.

Many buildings are designed such that access for maintenance, repair or replacement is not possible without damaging – or seriously risking damaging – other building elements. This can become a considerable deterrent to proper maintenance thus compromising the performance of the subject materials, components and assemblies, or other elements of the building. In cases where it is known or expected that maintenance, repair or replacement is likely to be required for certain elements before such time as the building undergoes a major retrofit, special consideration should be given to providing easy access to those elements. Anchorage points for maintenance personnel should be considered during the design of multi-storey buildings, including those of wood-frame construction, as adding them post-construction can be difficult.

Where the use of a building or space, or the services for a building or space, are changed significantly, an assessment of the impact of the changes on the environmental separators should be conducted to preclude premature failures that could create hazardous conditions.

A-5.2.1.1.(3) Soil Temperatures.

In theory, soil temperatures are needed to determine the conformance of a design to the requirements related to heat transfer and vapour diffusion. In practice, standard construction in a particular area may have proven to perform quite adequately and detailed calculations of soil temperature are unnecessary. (See also Sentence 5.2.1.3.(2).)

A-5.2.1.2.(1) Interior Environmental Loads.

The interior environmental conditions required depend on the intended use of the spaces in the building as defined in the building program. Spaces in different types of buildings and different spaces within a single building may impose different loads on the separators between interior and exterior spaces and between adjacent interior spaces. The separators must be designed to withstand the expected loads.

A-5.2.2.1.(2)(c) Determination of Structural Loads and Effects.

For the design of post-disaster buildings, the effects of earthquake loads on the ability of materials, components and assemblies and their interfaces to resist or accommodate environmental loads must be taken into account. For such buildings, seismic effects must be taken into account in the design for environmental separation, as these buildings are required to have an adequate degree of functionality after the seismic event to meet their intended function (see Article 4.1.8.13. for deflections and drift limits for post-disaster buildings). For all other buildings, damage to building components during seismic events is anticipated and these buildings are not intended to be functional after the event.

- a10.1 However, it is important to note that earthquake effects must be taken into account in the seismic design of all building materials, components and assemblies and their interfaces covered by Article 4.1.8.18. to address life safety and the structural protection of buildings.

A-5.2.2.2. Resistance to Wind and Other Air Pressure Loads.

The wind load provisions apply to roofing and other materials subject to wind-uplift loads.

- e7 Note that, although Article 5.2.2.2. is specifically concerned with wind loads and directly references only two Sentences from Part 4, Sentence 5.2.2.1.(1) references all of Part 4 and would invoke Article 4.1.7.10. for example, that is concerned with air pressure loads on interior walls and partitions.

a10.1 A-5.2.2.2.(4) Membrane Roofing Systems.

Wind loads for membrane roofing systems must be calculated in accordance with Part 4. The tested uplift resistance and factored load should satisfy the requirements of the Commentary entitled “Limit States Design” in the *2015 Structural Commentaries (User’s Guide – NBC 2015: Part 4 of Division B)*.

The test method described in CAN/CSA-A123.21, “Dynamic Wind Uplift Resistance of Membrane-Roofing Systems”, applies only to membrane roofing systems whose components’ resistance to wind uplift is achieved by fasteners or adhesives. It does not apply to roofing systems that use ballasts, such as gravel or pavers, to secure the membrane against wind uplift.

In the case of membrane roofing systems in which the waterproof membrane is attached to the structural deck using mechanical fasteners, the wind-induced forces and the roofing system’s response are time- and space-dependent and, thus, dynamic in nature. Further information on the design and evaluation of such systems can be found in “A Guide for the Wind Design of Mechanically Attached Flexible Membrane Roofs”, published by NRC.

The wind uplift resistance obtained from the test method in CAN/CSA-A123.21 is limited to configurations with specific fastener or adhesive patterns. To extrapolate the test data to non-tested configurations, refer to ANSI/SPRI WD-1, “Wind Design Standard Practice for Roofing Assemblies”, for a rational calculation procedure. However, in using this extrapolation procedure, wind loads should be calculated in accordance with the NBC. NRC’s guide for wind design referenced above provides further guidance and examples of wind load calculations.

A-5.3. Heat Transfer.

In addressing issues related to health and safety, Section 5.3. calls up levels of thermal resistance needed to minimize condensation on or within environmental separators, and to ensure thermal conditions appropriate for the building use. Part 12 specifies levels of thermal resistance required for energy efficiency or calls up energy performance levels, which relate to levels of thermal resistance. Where Part 5 calls for levels of thermal resistance higher than those required by Part 12, the requirements of Part 5 take precedence.

A-5.3.1.1. Required Resistance to Heat Transfer.

The control of heat flow is required wherever there is an intended temperature difference across the building assembly. The use of the term “intended” is important since, whenever interior space is separated from exterior space, temperature differences will occur.

The interior of an unheated warehouse, for example, will often be at a different temperature from the exterior due to solar radiation, radiation from the building to the night sky and the time lag in temperature change due to the thermal mass of the building and its contents. If this temperature difference is not “intended,” no special consideration need be given to the control of heat flow.

If the warehouse is heated or cooled, thus making the temperature difference “intended,” some consideration would have to be given to the control of heat flow.

It should be noted, however, that in many cases, such as with adjacent interior spaces, there will be an intended temperature difference but the difference will not be great. In these cases, the provisions to control heat flow may be little or no more than would be provided by any standard interior separator. That is, materials typically used in the construction of partitions may provide the separation needed to meet the requirements of Section 5.3. without adding what are generally considered to be “insulating” materials.

a10.1 A-5.3.1.2. Material and Component Properties and Condensation.

Total prevention of condensation is generally unnecessary and its achievement is rarely a certainty at design conditions. Part 5, therefore, requires that condensation be minimized. The occurrence of condensation should be sufficiently rare, or the quantities accumulated should be sufficiently small and dry rapidly enough, to avoid material deterioration and the growth of mould and fungi.

The Harmonized North American Fenestration Standard, AAMA/WDMA/CSA 101/I.S.2/A440, “NAFS – North American Fenestration Standard/Specification for Windows, Doors, and Skylights”, identifies procedures to determine the condensation resistance and thermal transmittance of windows, doors and skylights though testing for condensation resistance is presented as optional in the standard. As such, a fenestration product that meets the standard’s requirements on air leakage, water penetration, uniform load and other performance requirements may not meet the condensation resistance performance level needed for a given application.

Only the physical test procedure presented in CSA A440.2, “Fenestration Energy Performance”, can be used to establish the temperature index (I) value, which denotes condensation resistance performance evaluation criteria. It is recommended that designers specify I values for a given application to minimize the potential for condensation. Further guidance on the selection of the correct I value is provided in CSA A440.3, “User Guide to CSA A440.2-14, Fenestration Energy Performance”.

The scope of AAMA/WDMA/CSA 101/I.S.2/A440, which is referenced in Subsection 5.10.2., includes skylights and tubular daylighting devices (TDD). Where skylights and TDDs pass through unconditioned space, their wells and shafts may become the environmental separator and would therefore have to comply with the requirements of Part 5.

A-5.3.1.2.(1) Use of Thermal Insulation or Mechanical Systems for Environmental Control.

The level of thermal resistance required to avoid condensation on the warm side of an assembly or within an assembly (at the vapour barrier) and to permit the maintenance of indoor conditions appropriate for the occupancy depends on:

- the occupancy
- the exterior design air temperature
- the interior design air temperature and relative humidity
- the capacity of the heating system, and
- the means of delivering heat.

- e7 To control condensation on the interior surface of an exterior wall, for example, the interior surface must not fall below the dew point of the interior air. If, for instance, the interior air is 20°C and 35% RH, the dew point will be 4°C. If the interior air is 20°C and 55% RH, the dew point will be 11°C.

Exterior design temperatures are low in Ontario; for example, -20°C in Toronto, and -35°C in Geraldton. In these cases, maintaining temperatures inboard of the vapour barrier above the dew point requires insulation.

In addition to controlling condensation, interior surface temperatures must be warm enough to avoid occupant discomfort due to excessive heat loss by radiation. Depending on the occupancy of the subject spaces, this may require the installation of insulation even where it is not needed to control condensation.

A-5.3.1.3.(2) Position of Materials Providing Thermal Resistance.

For a material providing thermal resistance to be effective, it must not be short-circuited by convective airflow through or around the material. The material must therefore be either the component of the air barrier system providing principal resistance to air leakage, or installed in full and continuous contact with a continuous low air permeance component.

A-5.4.1.1. Resistance to Air Leakage.

An air barrier system in above-grade building components and assemblies separating conditioned space from the exterior will reduce the likelihood of condensation due to air leakage, discomfort from drafts, the infiltration of dust and other pollutants, and interference in the performance of building services, such as HVAC and plumbing.

These problems can all lead to serious health or safety hazards.

Currently, the most obvious and significant problems are due to moisture-related material deterioration, such as rot and corrosion, which can lead to the failure of component connections. The infiltration of dust and other pollutants can lead to a wide range of health problems. Where the separator is subject to high moisture levels, the pollutants may include fungus spores. Interference with the performance of building services can lead to unhealthy conditions and potentially hazardous conditions during the heating season in many regions of the province.

There are few buildings intended for human occupancy where the interior space is conditioned but where an air barrier system is not required. Some industrial buildings, for example, may be exempt. This would depend, however, on the particular levels of interior conditioning provided, ventilation levels, protection provided for the workers, and the tolerance of the building's construction to the accumulation of condensation and potential precipitation ingress.

Some industrial buildings are provided with only limited conditioning, for example radiant heating, and ventilation levels are sufficient to reduce relative humidity to a level at which condensation will not accumulate to a degree that is problematic. Conversely, some industrial buildings, due to the processes they contain, operate at very high temperatures and high ventilation levels. In these cases, the building envelope will be maintained at temperatures that will avoid condensation. In both examples above, either the ventilation rates or protective gear required in the work environment would protect the occupants from unacceptable levels of pollutants.

Where adjacent interior environments are sufficiently different, controlling airflow between those spaces is necessary to maintain conditions. Referring again to the industrial building examples above, assemblies separating office space from the work floor would likely require an air barrier system.

An air barrier system may be required in components and assemblies in contact with the ground to control the transfer of soil gases such as radon and methane.

The word "minimize" is used in Clause 5.4.1.1.(1)(c) because not all moisture accumulation in an assembly need be of concern. Incidental condensation is normal but should be sufficiently rare and in sufficiently limited quantities, and should dry rapidly enough, to avoid material deterioration and the growth of mould or fungi.

An air barrier system is required in components and assemblies in contact with the ground to control the ingress of radon, and may be required to control the ingress of other soil gases such as methane.

In addition to an air barrier system, other measures may be required to reduce radon concentration to a level below the guideline specified by Health Canada. Further information on protection from radon ingress can be found in:

- “Radon: A Guide for Canadian Homeowners” (CMHC/HC),
- “Guide for Radon Measurements for Public Buildings (Schools, Hospitals, Care Facilities, Detention Centres)” (HC), and
- EPA 625/R-92/016, “Radon Prevention and the Design and Construction of Schools and Other Large Buildings”.

a10.1 A-5.4.1.2.(1) and (2) Air Leakage Through the Air Barrier System.

The current requirements specify only a maximum air leakage rate for the material in the air barrier system that provides the principal resistance to air leakage.

Research and in-situ testing of installed air barrier systems have shown that the bulk of air leakage occurs through joints (between air barrier materials) and junctions (between air barrier components).

Ideally, a maximum air leakage rate for the complete air barrier system would be specified. The maximum acceptable rate will ultimately depend on warm and cold side temperatures and humidity conditions, and on the susceptibility of the environmental separator to moisture-related deterioration. Recommended maximum leakage rates for the air barrier system in an exterior envelope in most locations in Ontario are shown in Table A-5.4.1.2.(1) and (2). These values are for air barrier systems in opaque, insulated portions of the building envelope. They are not for whole buildings, as windows, doors and other openings are not included. The Table is provided for guidance when testing air barrier systems as portions of an envelope.

**Table A-5.4.1.2.(1) and (2)
Recommended Maximum Air Leakage Rates**

Warm Side Relative Humidity at 21°C	Recommended Maximum System Air Leakage Rate, L/(s • m ²) at 75 Pa
< 27%	0.15
27% to 55%	0.10
> 55%	0.05

Determining the leakage rate of a particular assembly, however, is problematic. There is little information available on the airtightness of the many air barrier systems used in building construction, and testing requires specialized equipment and expertise. Depending on the type of test,

- testing may not represent the performance of the complete installed system,
- the location of deficiencies may be difficult to identify, and
- rectification of deficiencies may not be feasible.

Despite the difficulties, when using a system whose performance is not known, it is recommended that tests be conducted. Testing options include:

- laboratory tests of small sections of the air barrier system, including the joints and intersections of different assemblies
- laboratory tests of large wall sections
- in-situ tests of characteristic envelope areas.

A-5.5.1.1. Required Resistance to Vapour Diffusion.

Resistance to vapour diffusion is required to reduce the likelihood of condensation within building assemblies, and the consequent potential for material deterioration and fungal growth. Deterioration such as rot and corrosion can lead to the failure of building components and connections, and interfere with the performance of building services. Some fungi can have very serious effects on health.

In Ontario, relatively few buildings that are subject to temperature and vapour pressure differences would be constructed or operated in such a manner that the control of vapour diffusion would not need to be addressed in their design. Assemblies enclosing certain industrial spaces, as described in Appendix Note A-5.4.1.1. for example, may be exempt.

For residential spaces and most other spaces that are conditioned for human occupancy, a means of vapour diffusion control is generally agreed to be necessary. The questions in those cases pertain to the degree of control needed.

The word “minimize” is used in Sentence 5.5.1.1.(1) because not all moisture accumulation in an assembly need be of concern. Incidental condensation is normal but should be sufficiently rare and in sufficiently limited quantities, and should dry rapidly enough, to avoid material deterioration and the growth of mould or fungi. The following publications address the effects of fungi on health:

- HC 2004, “Fungal Contamination in Public Buildings: Health Effects and Investigation Methods”
- “Guidelines on Assessment and Remediation of Fungi in Indoor Environments”, New York City Department of Health and Mental Hygiene (NYCDOHMH)

A-5.5.1.2.(1) Vapour Barrier Materials and Installation.

In the summer, many buildings are subject to conditions where the interior temperature is lower than the exterior temperature. Vapour transfer during these periods is from the exterior to the interior. In general, in Canada, the duration of these periods is sufficiently short, the driving forces are sufficiently low, and assemblies are constructed such that any accumulated moisture will dissipate before deterioration will occur.

Buildings such as freezer plants, however, may operate for much of the year at temperatures that are below the ambient exterior temperature. In these cases, the “warm” side of the assembly would be the exterior and a detailed analysis on an annual basis is required.

Steady state heat transfer and vapour diffusion calculations may be used to determine acceptable permeance levels for the vapour barrier and to identify appropriate positions for the vapour barrier within the building assembly.

A-5.6.1.1. Required Protection from Precipitation.

Windows, cast-in-place concrete walls, and metal and glass curtain wall systems are examples of components and assemblies that, when properly designed and constructed, are expected to prevent the ingress of precipitation into a building. Assemblies such as roofs and veneer walls consist of materials specifically intended to screen precipitation.

Components and assemblies separating interior conditioned space from the exterior are generally required to provide protection from the ingress of precipitation. Components and assemblies separating interior unconditioned space from the exterior may or may not be required to provide protection from the ingress of precipitation. Buildings such as stadia, parking garages and some seasonally occupied buildings, for example, may not require complete protection from the ingress of precipitation. The degree of protection will depend to a large extent on the materials selected for the building elements that will be exposed to precipitation.

The word “minimize” is used in Sentence 5.6.1.1.(1) because not all moisture ingress or accumulation in an assembly need be of concern. The penetration of wind-driven rain past the cladding may not affect the long-term performance of the assembly, provided the moisture dries out or is drained away before it initiates any deterioration of building materials. When the design service life of a material or component is longer than the design service life of the overall assembly, taking into account the expected exposure to moisture, initiating deterioration of the material should not be of concern. That is to say, provided the material or component continues to provide the necessary level of performance for its intended service life and does not adversely affect the service life of the assembly of which it is a part, the deterioration of the material or component is not an issue.

A-5.6.1.2.(3) Ice Damming.

Water leakage through sloped roofs is often due to the formation of ice dams at the eaves, which can be limited by controlling the transfer of heat to the roof through a combination of insulation and venting to dissipate heat. See Subclause 5.3.1.2.(1)(a)(iv).

a10.1 A-5.6.1.2.(4) Vegetative Roofing Systems.

The integrity of some assemblies installed to provide the required protection from the ingress of precipitation in vegetative roofing systems can be compromised due to an inadequate resistance to the penetration of plant roots and rhizomes. Additional information on vegetative roofing systems and the performance of protective materials can be found in the German Landscape Research, Development and Construction Society's (FLL) "Guideline for the Planning, Execution and Upkeep of Green-Roof Sites" and in the National Roofing Contractors Association's Vegetative Roof Systems Manual.

A-5.6.2.1. Sealing and Drainage.

Providing a surface-sealed, durable, watertight cover on the outside of a building is difficult. Where there is a likelihood of some penetration by precipitation into a component or assembly, drainage is generally required to direct the moisture to the exterior.

- a3** The degree of protection against precipitation ingress needed in any particular case and the approach taken to provide that protection will depend on factors such as,
- the exterior loads imposed on the assembly,
 - the materials selected for the backing assembly,
 - the use of the enclosed space, and
 - the level of maintenance that will be acceptable to the owners.

- a10.1** Where exterior loads are greater, it may be prudent to select a precipitation protection system whose small failures will not be as likely to have an immediate impact on the building or its occupants. For example, drained and vented wall and vented roof assemblies are typical for low-rise residential buildings. More robust drained and vented wall assemblies are recommended for mid- and high-rise buildings where the cost of maintenance and repair could be high.

Where materials with a greater resistance to moisture are used in the assembly, a less rugged precipitation protection system or a less rigorous maintenance schedule may be acceptable. This might be the case, for example, where the wall or backing wall is concrete or masonry.

- a3** For spaces that are not intended for on-going human occupancy, some rainwater leakage may be of lesser concern. This may be the case for certain warehouse spaces for example, depending on how the spaces are used and conditioned.

Information on the installation of flashing to drain water to the exterior of roof and wall assemblies may be found in a number of publications including, but not limited to:

- "Architectural Sheet Metal Manual", Sheet Metal and Air-Conditioning Contractors National Association, Inc.
 - "High-Rise Residential Construction Guide", Tarion Warranty Corporation (formerly Ontario New Home Warranty Program)
 - Technical Notes, National Concrete Masonry Association
 - Roofing Specifications, Canadian Roofing Contractors' Association
- e7**
- "The NRCA Roofing Manual: Membrane Roof Systems" and "The NRCA Waterproofing Manual," National Roofing Contractors Association
 - Technical Notes on Brick Construction, Brick Industry Association

- a10.1** Environmental separators installed in buildings of wood construction that exceed 4 storeys can be subjected to increased loading due to the height of the building. As such, certain design considerations may require different approaches from the common ones used by industry for buildings of 4 storeys or less. These considerations include, but are not limited to, the following:

- air barrier assemblies,
- fenestration selection,
- protection from precipitation,
- differential movement due to wood shrinkage,
- roofing selection and design, and
- risk of deterioration due to longer exposure of materials to the elements during construction.

a10.1 Information on environmental separators and the loading to which they are subjected when installed in buildings of wood construction, as well as recommendations on dealing with differential movement, can be found in the following publications, among others:

- “Moisture and Wood-Frame Buildings”, Canadian Wood Council
- “Guide for Designing Energy-Efficient Building Enclosures for Wood-Frame Multi-Unit Residential Buildings in Marine to Cold Climate Zones in North America”, FPIInnovations and RDH Building Engineering Ltd.

a10.1 A-5.7. Protection from Interior Sources of Water.

Protection similar to that prescribed in Section 5.7. may be required where interior assemblies are in contact with water (such as site-built showers, steam rooms, swimming pool areas) and where adjacent interior spaces need to be protected from the transfer of water through these assemblies.

a10.1 A-5.7.1.2.(2) Drainage.

Water should be directed away from the building and, ultimately, to a municipal drainage system, drainage ditch, swale, or other acceptable water management means. This can be accomplished by setting the building grade higher than the surrounding grades, by sloping the grade away from the building, by installing a surface water drainage system, or by a combination of these approaches. The chosen approach should follow generally accepted guidelines, such as the Rational Method of Stormwater Design by David B. Thompson, or other design methods acceptable to the authority having jurisdiction.

a10.1 A-5.7.3.3.(1)(a) Imperfections.

Examples of imperfections include shrinkage cracks, air holes, honeycombing, form-tie cone holes, and form joint ridges.

a10.1 A-5.7.3.4.(1) Dampproofing.

Dampproofing refers to the application of a material or materials to an environmental separation assembly to protect it and the interior space against the transfer of moisture due to the mechanisms of water vapour transmission, capillary action and pressure differences other than hydrostatic pressure.

A dampproofed assembly should be designed such that it can provide short-term resistance to the ingress of water due to occasional hydrostatic pressure from ground water.

a10.1 A-5.8. Required Protection from Noise.

Section 5.8. applies to the separation of dwelling units from other dwelling units and from spaces where noise may be generated with regard to sound transmission irrespective of Clause 5.1.2.1.(1)(b), which deals with the separation of dissimilar environments. It is understood that, at any time, there is the potential for sound levels to be quite different in adjoining dwelling units.

a10.1 A-5.8.1.2. Using ASTC in Lieu of STC.

A designer may choose to use an ASTC rating of equal or higher numerical value than the required STC to show compliance where STC ratings are required.

An ASTC measurement or calculation will always yield a value equal to or lower than the STC for the same configuration, as the ASTC includes flanking transmission.

a10.1 A-5.8.1.4. Methods of Calculating ASTC.

The technical concepts, terminology, and calculation procedures relating to the detailed and simplified ASTC calculation methods are discussed in detail, with numerous worked examples, in the NRC publication entitled “Guide to Calculating Airborne Sound Transmission in Buildings”. This Guide includes references to readily-available sources of pertinent data.

For many common constructions, the calculations required by Article 5.8.1.4. can be performed using software tools, such as soundPATHS, which is available on NRC’s Web site.

The simplified calculation method may not always identify the prominent flanking paths. Furthermore, it corresponds more closely with the results of the detailed calculation method where the separating assembly and the flanking constructions are both constructed according to the same method, i.e. either both are lightweight construction (steel or wood framing) or both are heavyweight construction (masonry or concrete).

A-5.10.1.1.(1) Selection of Materials and Components and Compliance with Referenced Standards.

Note that Sentence 5.10.1.1.(1) is drafted in such a way that the selection of materials and components is not limited to those traditionally recognized as serving particular functions or those for which a standard is identified in Table 5.10.1.1. This approach permits more flexibility than is provided by similar requirements in Part 9. As long as the selected material meets the performance requirements stated elsewhere in Part 5, the material may be used to serve the required function.

However, where the selected material or component, or its installation, falls within the scope of any of the standards listed in Table 5.10.1.1., the material, component or installation must comply with that standard. For example, if some resistance to heat transfer is required between two interior spaces and standard partition construction will provide the necessary resistance, the installation of one of the “thermal insulation” materials identified in the standard list is not required. If, on the other hand, one decides to install glass fibre insulation, the material must conform to CAN/ULC-S702, “Mineral Fibre Thermal Insulation for Buildings”.

A-Table 5.10.1.1. Selection and Installation of Sealants.

Analysis of many sealant joint failures indicates that the majority of failures can be attributed to improper joint preparation and deficient installation of the sealant and various joint components. The following ASTM guidelines describe several aspects that should be considered when applying sealants in unprotected environments to achieve a durable application:

- ASTM C 1193, “Use of Joint Sealants”,
- ASTM C 1299, “Selection of Liquid-Applied Sealants”,
- ASTM C 1472, “Calculating Movement and Other Effects When Establishing Sealant Joint Width”.

The sealant manufacturer’s literature should always be consulted for recommended procedures and materials.

A-5.10.2.1.(3) Airtightness and Watertightness of Wired Glass Windows.

Fixed wired glass assemblies are sometimes permitted as closures in vertical fire separations. The airtightness and watertightness requirements are waived for these windows when used in such an application, in recognition of the fact that the availability of assemblies that meet both the requirements of the window standards and the requirements for fire resistance may be limited. However, control of air and water leakage should not be ignored: measures should be taken to attempt to comply with applicable requirements.

A-5.10.2.2. Manufactured Windows, Doors and Skylights.

Design Values

- e7 CSA A440S1, “Canadian Supplement to AAMA/WDMA/CSA 101/I.S.2/A440-11, NAFS – North American Fenestration Standard/Specification for Windows, Doors, and Skylights”, requires that the individual performance levels achieved by the product for structural resistance, water penetration resistance and air leakage resistance be reported on the product’s performance label.

Storm Doors and Windows

Where storm doors and storm windows are not incorporated in a rated window or door assembly, they should be designed and constructed to comply with the applicable requirements of Part 5 regarding such properties as appropriate air leakage and structural loads.

Forced Entry Test

Even though the performance label on rated windows, doors and skylights does not explicitly indicate that the product has passed the forced entry resistance test, products are required to pass this test in order to be rated.

a10.1 A-5.10.2.3.(1) Installation and Field Testing of Windows, Doors and Skylights.**Installation**

The installation details of windows, doors, skylights and their components must be appropriately designed and implemented for the building envelope assembly to perform acceptably overall. The proper design of the installation details provides the information necessary to integrate the structure and air, vapour and moisture barrier functions of windows, doors and skylights into the overall design of the building envelope assembly. Construction should be carried out in accordance with these details to achieve an appropriate level of long-term performance. Further guidance on installation detailing can be found in CAN/CSA-A440.4, “Window, Door, and Skylight Installation”.

Field Testing

It is recommended that the performance of installed windows, doors and skylights be field tested early in the envelope construction phase so that any discontinuities can be readily identified and corrected before construction of the building envelope assembly is completed. Additional field testing during subsequent construction phases to monitor installation consistency is also recommended. Field test procedures should be carried out in accordance with test standards such as ASTM E783, “Field Measurement of Air Leakage Through Installed Exterior Windows and Doors”, and ASTM E1105, “Field Determination of Water Penetration of Installed Exterior Windows, Skylights, Doors, and Curtain Walls, by Uniform or Cyclic Static Air Pressure Difference”. Further guidance can be found in Annex D of CAN/CSA-A440.4, “Window, Door, and Skylight Installation”, however, the performance requirements developed in AAMA/WDMA/CSA 101/I.S.2/A440, “NAFS – North American Fenestration Standard/Specification for Windows, Doors, and Skylights”, should be used rather than the industry performance data values listed in CAN/CSA-A440.4.

A-5.10.2.4.(3) Heat Transfer Through Fire-Rated Glazed Assemblies.

Thermal bridging through fire-rated glazed assemblies should not be ignored; measures should be taken to minimize condensation consistent with the intent of Sentence 5.10.2.4.(2).

a10.1 A-5.10.3.1.(1) Exterior Insulation Finish Systems (EIFS).

The reference to CAN/ULC-S716.1, “Exterior Insulation and Finish Systems (EIFS) – Materials and Systems”, in Clause 5.10.3.1.(1)(b) does not preclude the use of other component materials that may also meet the intent of the Code. For example, using mineral-fibre insulation in lieu of other rigid insulation types, mechanical fastening methods for the insulation component in lieu of adhesive, or a type of water-resistive barrier other than a liquid-applied water-resistive barrier could be acceptable.

The following two companion standards facilitate the application of and conformance with CAN/ULC-S716.1:

- CAN/ULC-S716.2, “Exterior Insulation and Finish Systems (EIFS) – Installation of EIFS Components and Water Resistive Barrier”, and
- CAN/ULC-S716.3, “Exterior Insulation and Finish System (EIFS) – Design Application”.

Additional information on EIFS design and installation can be found in the EIFS Council of Canada’s “EIFS Practice Manual” and the manufacturer’s literature.

EIFS Selection

CAN/ULC-S716.1 provides minimum performance criteria for EIFS materials and systems that are tested under specific laboratory test protocols identified in the standard. However, compliance with this standard does not ensure that a system is appropriate for all projects. When selecting an EIFS product, designers should consider all relevant criteria—not only those covered by the tests in CAN/ULC-S716.1—including, but not limited to,

- building exposure
- local climate characteristics (wind, precipitation, temperature variations, solar exposure)
- intended building use
- intended resistance to damage and deterioration
- construction tolerances
- constructability

Design and Construction of EIFS Drainage Cavity

The drainage capacity and thermal performance of the EIFS assembly can be affected by the dimensions and configuration of the EIFS drainage cavity.

EIFS are installed over other building materials such as sheathing and primary structural components, which have various construction installation tolerances. Designers should take into consideration the cumulative effects of construction tolerances and sequencing when specifying the drainage method and the cavity dimensions and configuration in order to ensure adequate drainage.

Designers should also take into account the impact of air movement, which varies depending on cavity size and the extent of venting, on the EIFS' thermal performance when reviewing the overall thermal performance of the building envelope. ASTM C 1363, "Thermal Performance of Building Materials and Envelope Assemblies by Means of a Hot Box Apparatus", presents one method for assessing the thermal performance of assemblies.

a10.1 A-5.10.4. Testing Standards for Other Fenestration Assemblies.

Subsection 5.10.4. references ASTM test methods. The following AAMA standards can also be used to evaluate the performance characteristics of other fenestration assemblies:

- AAMA 501, "Test for Exterior Walls",
- AAMA 501.1, "Water Penetration of Windows, Curtain Walls and Doors Using Dynamic Pressure",
- AAMA 501.2, "Quality Assurance and Diagnostic Water Leakage Field Check of Installed Storefronts, Curtain Walls, and Sloped Glazing Systems",
- AAMA 501.4, "Recommended Static Test Method for Evaluating Curtain Wall and Storefront Systems Subjected to Seismic and Wind Induced Interstory Drifts",
- AAMA 501.5, "Thermal Cycling of Exterior Walls", and
- AAMA 501.6, "Recommended Dynamic Test Method for Determining The Seismic Drift Causing Glass Fallout From A Wall System".

a10.1 A-5.10.4.1.(1) Terminology for Other Fenestration Assemblies.

Curtain Wall

A curtain wall is considered to be a continuous wall cladding assembly (which may include fenestration and opaque portions) that is hung away from the edge of the primary floor structure. Curtain wall assemblies do not generally support vertical loads other than their own weight. Anchorage is typically provided by anchors that connect back to the floor structure. Curtain wall assemblies can be either "stick built," meaning each main unit is assembled on-site, or a "unitized" system, meaning factory-assembled main units are installed and connected together on-site.

Window Wall

A window wall is considered to be a wall cladding assembly (which may include fenestration and opaque portions) that spans from the top of a primary floor structure to the underside of the next higher primary floor structure. Window wall assemblies do not generally support vertical loads other than their own weight. Primary provision for anchorage occurs at head and sill connections with the adjoining floor structure. Window wall assemblies may include separate or integral floor edge covers.

Storefront

A storefront is considered to be a non-residential assembly (which may include fenestration and opaque portions) consisting of one or more elements that could include doors, windows and curtain wall framing. Storefronts do not generally support vertical loads other than their own weight. Storefront profiles are typically narrow, rectilinear framing members that hold a combination of pocket glazing and applied glazing stops to securely retain the infills. Vertical framing members typically span the height of one floor or are retained within a structural punched opening.

Storefront assemblies are designed/selected to take into account the anticipated service and exposure conditions, which may be different than for other portions of the building.

Glazed Architectural Structures

Glazed architectural structures are considered glazing assemblies that are supported in a non-traditional manner, such as corner-clamped, point-supported, linear-supported and edge-clamped glazing. Structural support systems can include, but are not limited to, tension cables, tension rods, steel and glass. Glazed architectural structures do not generally support vertical loads other than their own weight. These assemblies are designed/selected to take into account the anticipated service and exposure conditions, which may be different than those for other portions of the building.

Skylights that are not covered by AAMA/WDMA/CSA 101/I.S.2/A440, “NAFS – North American Fenestration Standard/Specification for Windows, Doors, and Skylights,” are considered glazed architectural structures.

a10.1 A-5.10.4.2.(1) Structural Loads and Environmental Loads.

The applicable laboratory test method for demonstrating adequate structural performance of other fenestration assemblies is ASTM E330 / E330M, “Structural Performance of Exterior Windows, Doors, Skylights and Curtain Walls by Uniform Static Air Pressure Difference”.

a10.1 A-5.10.4.3.(1) Resistance to Condensation.

Notwithstanding that other fenestration assemblies are not fully covered under the testing scope of CSA A440.2, “Fenestration Energy Performance”, the test method described therein can be used to evaluate their resistance to condensation, with technical modifications to accommodate differences in the size and configuration of the specimen. It is also common practice to use one cold cycle of AAMA 501.5, “Thermal Cycling of Exterior Walls”, to assess the potential for condensation. Both methods can be used for mock-ups in laboratory performance evaluations, however, only the test method in CSA A440.2 should be used if a Temperature Index is required. In most cases, the project specification documents establish the hygrothermal conditions (i.e., exterior temperature, interior temperature, interior relative humidity) for which the potential for condensation should be minimized. Under these conditions, the aforementioned test methods can be used to aid in the selection of the appropriate system performance to minimize the potential for interior surface condensation. In all cases, care should be taken in the construction and configuration of the specimen, as these parameters may have an impact on its thermal performance and resistance to condensation. These parameters may include, without limitation, interior wall construction and finishes, heating systems, ventilation systems, etc., to simulate the actual in-service conditions as closely as practicable.

a10.1 A-5.10.4.4.(2) Air Leakage.

Air Leakage Rate and Test Pressure

A lower air leakage rate and/or higher differential test pressure can be selected for specific applications of other fenestration assemblies where tight control of airflow is required to prevent interstitial condensation (e.g., in concealed spaces), improve thermal comfort (e.g., in hospitals, seniors’ residences), or prevent the migration of airborne contaminants (e.g., in food and drug research, manufacturing applications, biological laboratories). It is typical of other fenestration assemblies to be used as the sole building envelope component; where this is the case, a correspondingly higher degree of airtightness may be required.

In addition, higher test pressure differentials can be used to evaluate assemblies with low air leakage, such as non-operable or fixed fenestration systems whose air leakage rates are not easily measurable at the lower standard pressure differentials.

Standard Test Methods

The applicable laboratory test method for determining the rate of air leakage is ASTM E 283, “Determining Rate of Air Leakage Through Exterior Windows, Curtain Walls, and Doors Under Specified Pressure Differences Across the Specimen”. If field testing for air leakage is to be conducted, the applicable test method is ASTM E 783, “Field Measurement of Air Leakage Through Installed Exterior Windows and Doors”.

a10.1 A-5.10.4.4.(3) Systems Excluded from Air Leakage Requirements.

The systems listed in Sentence 5.10.4.4.(3) perform different functions than other fenestration assemblies and are therefore exempted from complying with the air leakage requirements.

a10.1 A-5.10.4.5.(2) Standard Test Methods.

The applicable laboratory test method for determining the water penetration resistance of curtain walls and storefront assemblies is ASTM E331, “Water Penetration of Exterior Windows, Skylights, Doors, and Curtain Walls by Uniform Static Air Pressure Difference”. The applicable laboratory test method for window wall assemblies is either ASTM E331 or ASTM E547, “Water Penetration of Exterior Windows, Skylights, Doors, and Curtain Walls by Cyclic Static Air Pressure Difference”.

If field testing for water penetration is to be conducted, the applicable test method is ASTM E 1105, “Field Determination of Water Penetration of Installed Exterior Windows, Skylights, Doors, and Curtain Walls, by Uniform or Cyclic Static Air Pressure Difference”.

a10.1 A-5.10.4.5.(3) Water Penetration.

Notwithstanding that other fenestration assemblies are not covered under the testing scope of CSA A440S1, “Canadian Supplement to AAMA/WDMA/CSA 101/I.S.2/A440-11, “NAFS – North American Fenestration Standard/Specification for Windows, Doors, and Skylights”, they must be tested at the driving rain wind pressure calculated in accordance with the procedure described therein.

a10.1 A-5.10.4.5.(4) Systems Excluded from Water Penetration Requirements.

The systems listed in Sentence 5.10.4.5.(4) perform different functions than other fenestration assemblies and are therefore exempted from complying with the water penetration requirements.

A-6 Crawl Spaces Used as Warm Air Plenums.

The requirements for crawl spaces used as warm air plenums have not been included in this Part. Crawl spaces may be used as warm air plenums if design measures are taken to prevent moisture, soil or radon gases from entering the crawl space and being distributed throughout the space.

A-6.1.1.1.(2) Repairs and Alterations.

This requirement is to ensure that minimum life safety and health requirements are maintained when the operation and/or design is modified on existing heating, ventilating or air-conditioning systems. For example, this provision would apply to such cases as

- (a) the conversion of a heating appliance from oil to gas where venting and clearance requirements differ for chimneys and
- (b) the branching of a new duct from a main supply duct in which the new duct now penetrates a fire separation.

A-6.2.1.3. Structural Movement.

This Article is intended to remind designers and installers of mechanical systems of one aspect of the “good engineering practice” referred to in Article 6.2.1.1. In determining how to accommodate structural movement, there are two important principles to bear in mind:

- The prime concern of the Code is the safety of people in and around the building, as opposed to protection of the mechanical systems and equipment.
- The nature of the accommodation will vary with the type of movement being considered, taking into account particularly how often the movement is likely to be encountered over the life of the building.

For example, a gas line supported on columns that also support a crane must be installed in such a way that the movement of the columns, which occurs many times daily, does not cause the lines to break, thus creating a hazard. Even if the gas line installation could somehow be designed to break in a non-hazardous manner, it would hardly be recognized as good engineering practice if movement that occurs so frequently could disrupt the operation of the mechanical system.

On the other hand, earthquakes occur far less frequently and it would not be surprising to have a non-critical mechanical system fail as a result of an earthquake. However, even in this situation, the failure must occur in a manner that does not create a hazard to building occupants. For example, heavy mechanical equipment should be properly anchored so that it does not topple on building occupants during an earthquake. The design of the anchors should take into account accelerations consistent with the seismic data given in MMAH Supplementary Standard SB-1 for the location of the building. Part 4 provides guidance on the calculation of the loads such equipment would exert on the building structure during an earthquake; these same loads can be used in designing the anchors.

Some mechanical equipment can be an important component of post-disaster life safety systems. In these cases, the measures needed to accommodate the movements caused by an earthquake become even more critical since failure of the equipment would not be acceptable. Clearly, complying with this requirement will, in most cases, necessitate close coordination between the mechanical designer and the structural designer.

A-6.2.1.8.(1) Installation - General.

Ducts or pipes without dampers or valves are generally not considered to constitute “equipment” and are therefore not subject to this requirement.

A-6.2.2.1.(2) Minimum Flow Rate of Outdoor Make-up Air.

Except for self-contained mechanical ventilation systems serving a dwelling unit, the minimum flow rate of outdoor make-up air is listed in Table 2 of the ASHRAE 62 “Ventilation for Acceptable Indoor Air Quality” Standard. These values have been chosen to control air contaminants with an adequate margin of safety and to account for health variations among people, and varied activity levels.

A-6.2.2.1.(3) Self-Contained Mechanical Ventilation Systems.

When self-contained mechanical ventilation systems are to be designed under Part 6 instead of Subsection 9.32.3., the reference to Subsection 9.32.3. for conformance is intended to ensure that the principle design objectives of Subsection 9.32.3. (including total ventilation capacity, fan ratings, energy efficiency ratings for heat recovery ventilators, etc.) are met using good engineering practice criteria found in Part 6.

a10.1 A-6.2.2.3.(1) Storage Garages.

Areas where motor vehicles are parked with engine off for extended periods of time, such as car dealership showrooms, are not considered as storage garages.

A-6.2.2.3.(2) Ventilation of Storage Garages.

Storage garages are ventilated to protect occupants from exposure to carbon monoxide and other vehicular exhaust fumes. In certain cases, such as small two- or three-bay storage garages that are used for occasional vehicle storage, and where occupants are not present, carbon monoxide or nitrogen dioxide monitoring devices may be omitted if the ventilation system is interlocked with a local light switch or other controls to ensure continuous system operation whenever the area is occupied. In any event, the ventilation system capacity must be designed to limit the concentrations of carbon monoxide or nitrogen dioxide at or below the prescribed values.

a10.1 A-6.2.2.4. Indoor Air Contaminants.

Contaminants of Concern

Indoor air can contain complex mixtures of contaminants of concern such as formaldehyde, Legionella, mould and emissions from building materials. While some contaminants may be knowingly introduced — as in the case of processing and manufacturing environments—others may be unintentionally released into indoor environments. “Industrial Ventilation: A Manual of Recommended Practice for Design”, published by the ACGIH, and the “Exposure Guidelines for Residential Indoor Air Quality”, published by Health Canada, are useful references on the control of contaminants in industrial workplace environments and residential settings, respectively. These and other guidelines and manuals should be interpreted while keeping in mind the settings and purposes for which they were developed compared to those to which they will be applied. Note that such documents do not necessarily consider the interactions between various contaminants.

Minimizing the Growth and Spread of Bio-Contaminants

Bio-contaminants, such as bacteria, mould, mildew, fungi, viruses, and pollen, can thrive or be spread by sources like drain pans, spray- water air-washers, contaminated filters, poorly maintained cooling coils, water incursion into ductwork, cafeteria dishwasher drainage leaks, high humidity and stagnant water, potentially causing a wide range of adverse health effects including respiratory allergic reactions, asthma, and infectious diseases ranging from influenza to Legionnaires' disease.

Some of the control measures are as follows:

- a) Air-handling equipment should be accessible for the maintenance of filters, cooling coils and condensate drain pans located below the cooling coils. Access doors should be large and easy to open to facilitate thorough and regular maintenance.
- b) If moisture is added to building ventilation air to maintain humidity levels in a designated range, humidifiers that inject steam or water vapour into central air-handling units or main supply ducts are normally used. Injection nozzles should not be located in air-handling unit plenums or ductwork that is insulated with internal fibrous lining. If the lining becomes wet, conditions conducive to the growth and spread of bio-contaminants will result.

The above only addresses built-in features of an HVAC system that can help to minimize the growth and spread of bio-contaminants. Even more important than the built-in features is a program of regular maintenance and cleaning of those portions of the system where such growth is likely to occur.

A-6.2.2.4.(1) Removal of Contaminants.

While it is preferable to remove contaminants to the outdoors, if filtering devices are provided and are specifically designed for the purpose to clean the air to an acceptable indoor air quality limit, the cleaned air may be reused.

A-6.2.2.4.(2) Air Contaminants.

Shafts that constitute air ducts or that enclose air ducts used for the movement of environmental air shall not enclose

- (a) exhaust ducts used for the removal of smoke- and grease-laden vapours from cooking equipment,
- (b) ducts used for the removal of flammable vapours,
- (c) ducts used for moving, conveying, or transporting stock, vapour or dust,
- (d) ducts used for the removal of non-flammable corrosive fumes and vapours,
- (e) refuse and linen chutes, or
- (f) piping (except noncombustible piping conveying water or other nonhazardous or nontoxic materials).

A-6.2.2.5.(1) NFPA Publications Pertaining to the Heating, Ventilating and Air-Conditioning of Spaces Containing Hazardous Gases, Dusts or Liquids.

NFPA 30, "Flammable and Combustible Liquids Code"

NFPA 30A, "Motor Fuel Dispensing Facilities and Repair Garages"

NFPA 32, "Drycleaning Plants"

NFPA 33, "Spray Application Using Flammable and Combustible Materials"

NFPA 34, "Dipping and Coating Processes Using Flammable or Combustible Liquids"

NFPA 35, "Manufacture of Organic Coatings"

NFPA 36, "Solvent Extraction Plants"

NFPA 40, "Storage and Handling of Cellulose Nitrate Motion Picture Film"

NFPA 50A, "Gaseous Hydrogen Systems at Consumer Sites"

NFPA 50B, "Liquefied Hydrogen Systems at Consumer Sites,"

NFPA 51, "Design and Installation of Oxygen-Fuel Gas Systems for Welding and Cutting, and Allied Processes"

NFPA 51A, "Acetylene Cylinder Charging Plants"

NFPA 61, "Prevention of Fires and Dust Explosions in Agricultural and Food Processing Facilities"

NFPA 68, "Explosion Protection by Deflagration Venting"

NFPA 69, "Explosion Prevention Systems"

NFPA 85, "Boiler and Combustion Systems Hazards Code"

NFPA 86, “Ovens and Furnaces”
 NFPA 88A, “Parking Structures”
 NFPA 88B, “Repair Garages”
 NFPA 91, “Exhaust Systems for Air Conveying of Vapors, Gases, Mists and Noncombustible Particulate Solids”
 NFPA 96, “Ventilation Control and Fire Protection of Commercial Cooking Operations”
 NFPA 204, “Smoke and Heat Venting”
 NFPA 303, “Marinas and Boatyards”
 NFPA 307, “Construction and Fire Protection of Marine Terminals, Piers and Wharfs”
 NFPA 409, “Aircraft Hangars”
 NFPA 415, “Airport Terminal Buildings, Fueling, Ramp Drainage, Loading Walkways”
 NFPA 480, “Storage, Handling, and Processing of Magnesium Solids and Powders”
 NFPA 481, “Production, Processing, Handling and Storage of Titanium”
 NFPA 482, “Production, Processing, Handling, and Storage of Zirconium”
 NFPA 490, “Storage of Ammonium Nitrate”
 NFPA 650, “Pneumatic Conveying Systems for Handling Combustible Particulate Solid”
 NFPA 651, “Machining and Finishing of Aluminium and the Production of Handling of Aluminum Powders”
 NFPA 654, “Prevention of Fire and Dust Explosions from the Manufacturing, Processing, and Handling of Combustible Particulate Solids”
 NFPA 655, “Prevention of Sulfur Fires and Explosions”
 NFPA 664, “Prevention of Fires and Explosions in Wood Processing and Woodworking Facilities”
 NFPA “Fire Protection Guide to Hazardous Materials”

A-6.2.2.7.(1) Ventilation and Venting of Crawl Spaces and Attic or Roof Spaces.

Sentence 6.2.2.7.(1) requires that crawl spaces be ventilated either by natural (above-grade only) or mechanical means. High moisture levels within the crawl space can lead to problems such as the formation of mould, lifting of flooring or long-term damage to structural components. Crawl space ventilation cannot be expected to correct moisture-related problems caused by other factors like inadequate surface drainage from the foundation walls or improper protection against moisture from the ground. These conditions must be properly addressed so that crawl space ventilation can meet its intended objectives.

Several factors favour the use of mechanical ventilation rather than reliance on natural drafts. Local conditions, such as areas with high water tables, may dictate the need for mechanical ventilation to remove excessive moisture.

Crawl spaces should be maintained at a negative pressure relative to the conditioned area above to prevent the migration of moisture into occupied areas. This can be achieved through the use of an exhaust fan and relying on air transfer through floor penetrations, such as pipes.

a10.1 A-6.2.3.4. Duct Coverings and Linings.

The Thermal Insulation Association of Canada (TIAC) “Mechanical Insulation Best Practices Guide” 2013 edition is a comprehensive source of information on the selection, installation and proper use of thermal insulation materials. (Note that Section 4 of this Guide is not included in the scope of this Note as it contains information on proprietary products, which are not within the mandate of the Code.)

A-6.2.3.8.(5) and (6) Exhausting to Garages.

A frequent practice in the design of ventilation systems serving buildings which have associated parking garages is to discharge exhaust air from the building to the garage in order to reduce the cost of heating the garage or reduce the length of the exhaust ducts. However, this practice entails a certain amount of risk since, when the exhaust system is not running, stack effect may turn the exhaust outlets into intakes and exhaust fumes (including carbon monoxide) can be drawn from the garage into the building. Incorporating a backdraft damper at the exhaust outlet provides some additional protection but backdraft dampers are generally not regarded as being very reliable. Therefore this practice is only permitted in very limited circumstances and one needs to avoid negative pressure in the accessory rooms which are accessible only from the storage garage.

A-6.2.3.8.(6)(c) Air Contaminants.

For the purpose of Clause 6.2.3.8.(6)(c), washroom exhaust air is not considered to contain contaminants that would adversely affect the air quality in the storage garage.

a10.1 A-6.2.3.8. (7) and (18) Exhaust Ducts and Outlets.

Clothes dryers are a major cause of fires in buildings often due to a build-up of lint in the system, which then ignites or obstructs the venting or ventilation. Proper cleaning and regular maintenance of lint traps is directly proportional to the ease of access to the lint traps. It is therefore important to ensure that lint traps in multiple installations of laundry-drying equipment are installed in such a way as to allow easy access for inspection, maintenance, repair and cleaning.

A-6.2.3.8.(10)(b) Operation Diversity Factor.

The operation diversity factor has to be assessed for each specific application. Good engineering practice (see Article 6.2.1.1.) design guidelines can provide information on the subject. Figure A-6.2.3.8.(10)(b), which originates from the ASHRAE handbooks, provides an example of factors that can be used for general applications.

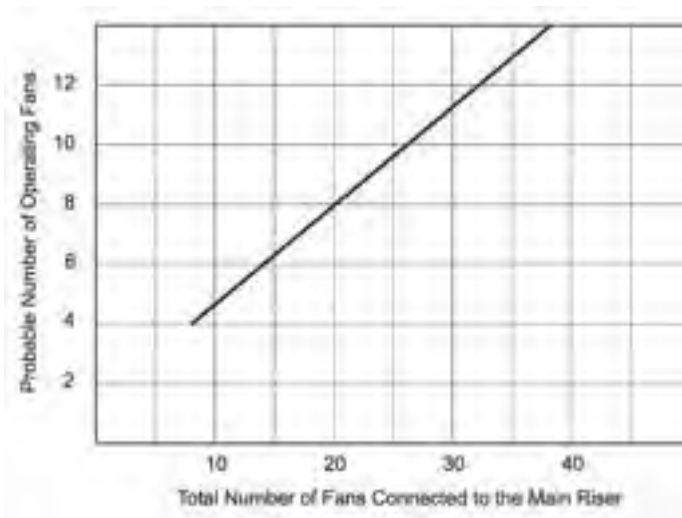


Figure A-6.2.3.8.(10)(b)
Operation Diversity Factor

A-6.2.3.12. Make-Up Air for Exhaust Systems.

When make-up air is introduced into a building in cold weather, it should be preheated when the comfort of people in the air path is a consideration.

a2 A-6.2.4.3.(11) Duct Seal Levels.

Seal Level	Sealing Requirements ⁽¹⁾
A	All transverse joints, longitudinal seams and duct wall penetrations.
B	All transverse joints and longitudinal seams.
C	All transverse joints.
Column 1	2

Notes to Table:

(1) Longitudinal seams are joints oriented in the direction of airflow. Transverse joints are connections of two duct sections oriented perpendicular to airflow. Duct wall penetrations are openings made by any screw fastener, pipe, rod, or wire. Spiral lock seams in ducts and adjustable joints of manufactured elbows need not be sealed. All other connections are considered transverse joints, including but not limited to spin-ins, taps, and other branch connections, access door frames and jambs, duct connections to equipment, etc.

A-6.2.4.4. Warm Air Supply Outlets.

If the heating system is designed to also distribute ventilation air, high inside wall or ceiling outlets with diffusers, and designed for such applications, may be used. In this case, low wall air-returns would be needed.

A-6.2.4.7.(3) Return Air System.

This requirement addresses radiant heat exposure directly between the heat exchanger or any other radiating parts located within the furnace cabinet, and the return air duct material. For the purposes of this Sentence, these parts do not include the furnace casing or cabinet. Clearances around the furnace casing are addressed by the Gas Installation Code and the appliance manufacturer's installation guide.

A-6.2.4.10. Clearances for Warm-Air Supply Ducts.

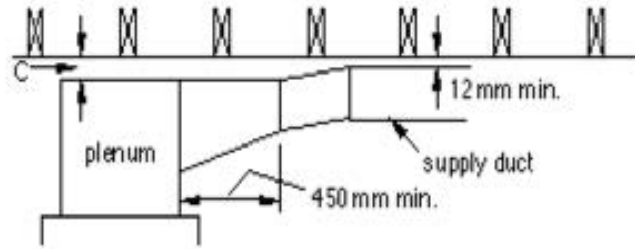


Figure A-6.2.4.10.(1)
Applicable to forced-air furnaces where permissible clearance C above plenum is 75 mm or less.

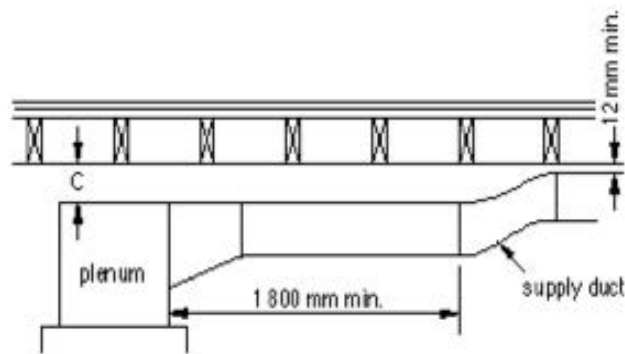


Figure A-6.2.4.10.(2)
Applicable to forced-air furnaces where permissible clearance C above plenum is more than 75 mm but not more than 150 mm.

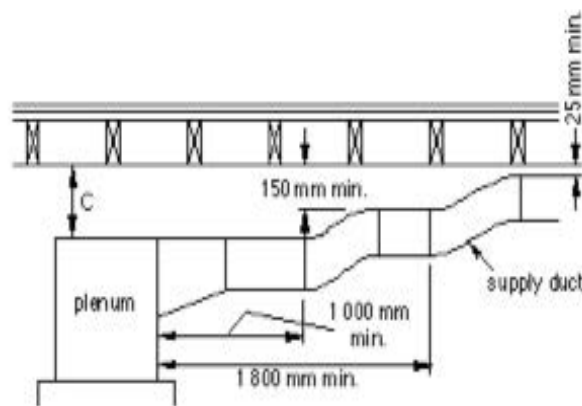


Figure A-6.2.4.10.(3)
Applicable to forced-air furnaces where permissible clearance C above plenum is more than 150 mm.

A-6.2.9.2.(6) Temperature of Exposed Piping.

Normally piping carrying steam or high-temperature hot water at pressures above atmospheric (corresponding temperature 100°C or above) will be insulated to reduce heat losses as an economy measure. Above a temperature of approximately 70°C, however, a bare pipe can cause a burn to human flesh coming in contact with the pipe. If pipes above this temperature are normally out of reach of all persons other than maintenance personnel or are properly guarded, it would be expected that no insulation would be needed for public safety.

A-7.1.5.4.(1) Separate Services.

Building sewers and water service piping serving buildings that are not located within the same property may be interconnected if the owners of the properties and the municipality enter into an agreement that is registered against the title to which it applies.

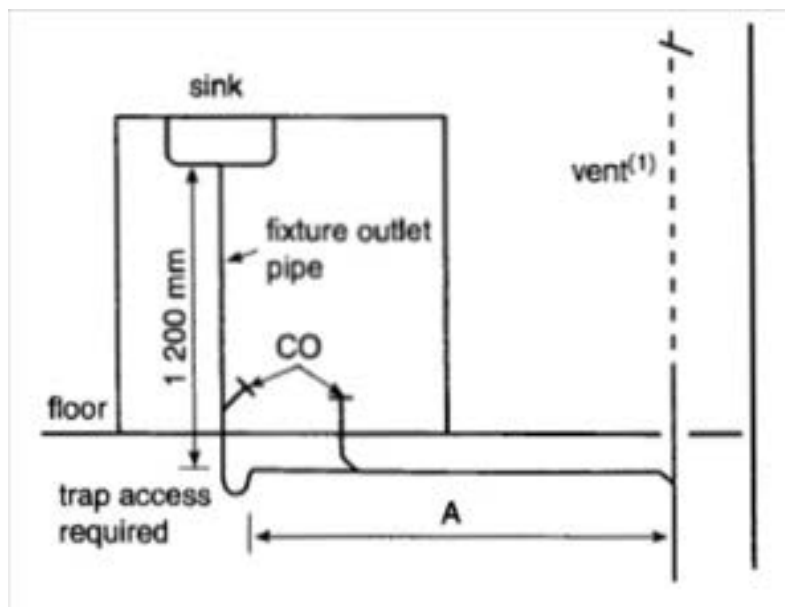
A-7.2.2.3.(1) Showers.

One method of ensuring that the floor complies with Sentence 7.2.2.3.(1) is to use a non-ferrous sheet metal or a rubber or plastic membrane and, where the protected floor area adjoins a perimeter wall, the water stop shall be turned up at least 100 mm above the waste opening.

A-7.2.2.6.(1) Centre Outlet Waste Fitting.

Centre outlet waste fitting means a drain that is equipped with a flat metal strainer at the waste inlet of a tailpiece and it is commonly known as a grid drain.

A-7.2.3.1.(3) Island Sink Installation.



(1) Vent to be sized in accordance with Article 7.5.6.3.

(2) Length A depends on trap size.

A-7.2.5.3.(3) Concrete Fittings.

Concrete fittings fabricated on the site from lengths of pipe may have proven acceptable on the basis of past performances in some localities and their acceptance as an alternative solution pursuant to Section 2.1. of Division C may be warranted.

A-7.2.5.6.(1) Polyethylene Pipe Used Underground.

Joints within the high-density polyethylene pipe (HDPE) shall be heat-fused according to the manufacturer's instructions. Joints between HDPE pipes and other materials shall be made with a suitable hubless coupling.

A-7.2.5.7.(1) Crosslinked Polyethylene Pipe and Fittings.

There are some special installation requirements for the use of crosslinked polyethylene pipe and its associated fittings. Reference should, therefore, be made to the installation information in CAN/CSA-B137.5, “Cross-Linked Polyethylene (PEX) Tubing Systems for Pressure Applications”.

A-7.2.5.10. to 7.2.5.12. Solvent Cement.

The CSA Standards CAN/CSA-B181.1, “Acrylonitrile-Butadiene-Styrene (ABS) Drain, Waste and Vent Pipe and Pipe Fittings”, CAN/CSA-B181.2, “Polyvinylchloride (PVC) and Chlorinated Polyvinylchloride (CPVC) drain, Waste, and Vent Pipe and Pipe Fittings”, and CAN/CSA-B137.6, “Chlorinated Polyvinylchloride (CPVC) Pipe, Tubing, and Fittings for Hot- and Cold-Water Distribution Systems” reference ASTM standard D3138, “Solvent Cements for Transition Joints Between Acrylonitrile-Butadiene-Styrene (ABS) and Poly(Vinyl Chloride)(PVC) Non-Pressure Piping Components”, which specifies the colour of the solvent cement. PVC cement shall be grey, ABS cement shall be yellow, CPVC cement shall be clear and transition cement shall be white. The standard colour allows code users to readily determine if the correct solvent cement has been used. It should be noted that a transition cement is not an all-purpose cement.

A-7.2.5.13.(1) Polyethylene/Aluminum/Polyethylene Composite Pipe and Fittings.

There are some special installation requirements for the use of polyethylene/aluminum/polyethylene composite pipe and fittings. Reference should, therefore, be made to the installation information in CAN/CSA-B137.9, “Polyethylene/Aluminum/Polyethylene (PE-AL-PE) Composite Pressure Pipe Systems”.

A-7.2.5.14.(1) Crosslinked Polyethylene/Aluminum/Crosslinked Polyethylene Composite Pressure Pipe and Fittings.

There are some special installation requirements for the use of crosslinked polyethylene/aluminum/crosslinked polyethylene composite pipe and fittings. Reference should, therefore, be made to the installation information in CAN/CSA-B137.10, “Crosslinked Polyethylene/Aluminum/Crosslinked Polyethylene (PEX-AL-PEX) Composite Pressure Pipe Systems”.

A-7.2.5.15.(1) Polypropylene Pipe and Fittings.

There are some special installation requirements for the use of polypropylene pipe and fittings. Reference should, therefore, be made to the installation information in CAN/CSA-B137.11, “Polypropylene (PP-R) Pipe and Fittings for Pressure Applications”.

A-7.2.6.7.(3) Galvanized Steel Pipe.

The use of galvanized steel pipe and fittings in a water distribution system may have proven acceptable on the basis of past performance in some localities and its acceptance as an alternative solution pursuant to Section 2.1. of Division C may be warranted.

A-7.2.10.16.(1) Air Admittance Valve.

An air admittance valve is a device that is closed by gravity and seals the vent terminal at zero differential pressure (no flow conditions) and under positive internal pressures. The valve allows air to enter the drainage system without the use of a vent extended to outside air and prevents trap siphonage.

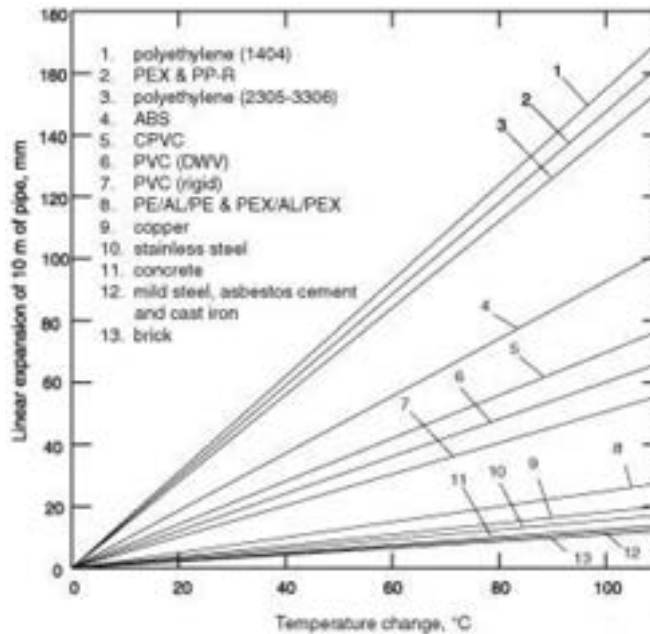
The material of the diaphragm can be damaged by exposure to acids or corrosive fumes in the ambient atmosphere; therefore, air admittance valves should not be installed in locations where there is a potential for exposure to such fumes.

A-7.3.2.6.(1) Mechanical Joints.

Storm sewer blockage can cause mechanical joints at the base of leaders to fail, which can result in flooding. The failure occurs because the cleanout joints at the base of the rainwater leaders are not able to withstand the water column pressure. To avoid such failures, it is necessary to ensure that storm water systems installed using mechanical joints be braced and/or restrained at the ends of branches, changes in direction and elevation, at dead ends and at other locations as required by the manufacturer to prevent the separation of joints due to internal pressure, mechanical stress or seismic events. Care should be taken to replace cleanouts properly after maintenance or testing.

A-7.3.3.9.(1) Expansion and Contraction.

Expansion and contraction in piping systems may be accommodated in a number of ways including, but not limited to, piping design and layout, material selection, and the inclusion of expansion joints.



Example:

To determine the expansion of 20 m of ABS pipe for a temperature change from 10°C to 60°C. Temperature change is $60 - 10 = 50^\circ\text{C}$

Enter the chart at 50°C, read up to the ABS line (#4), and then across to the mm scale. 47 mm/10 m of pipe therefore the change in length over 20 m is

$$20/10 \times 47 = 94 \text{ mm}$$

A-7.3.4.6.(1) Support for Underground Horizontal Piping.

Certified drain, waste and vent piping of polymeric plastic having schedule 40 dimensions shall be installed with select piping bedding where the fill over the pipe will be subject to vehicular traffic or where the burial depth exceeds eight feet.

Sewer pipe of polymeric plastic certified to a standard that requires a minimum pipe stiffness of 320 kPa shall be installed with select pipe bedding where the fill over the pipe will be subject to vehicular traffic or where the burial depth measured from the top of the pipe exceeds 750 mm.

Select pipe bedding consists of a non-cohesive ballast material of which at least 50% will pass a ¼ inch sieve and 100% will pass a ½ inch sieve, and that completely surrounds the pipe by a radial depth of at least four inches and that is sufficiently consolidated so that the intended earth loading will not produce further compaction.

A-7.3.4.9. Thrust Blocking.

Concrete thrust blocks may be used to provide restraint for underground water service piping. They are readily utilized in combination with tie rods, structural restraining, thrust collars and restrained joints. Thrust blocks are generally categorized as gravity blocks or bearing blocks. Important factors which may affect gravity block design are pipe sizes, water pressure, density of block material and allowable soil bearing pressure that will determine the minimum size of the block base.

Publications of pipe and fitting manufacturers show methods for installing thrust blocks at different fittings. In each case, the trench is cut to provide a bearing surface on undisturbed soil, and concrete is placed to fit snugly against as much of the

fitting as possible without interfering with access to fitting joints. Sometimes anchor rods may be used to hold the fitting against the blocks.

A-7.3.5.1.(1) Backfilling of Pipe Trench.

Stronger pipes may be required in deep fill or under driveways, parking lots, etc., and compaction for the full depth of the trench may be necessary.

Bedding is required primarily to provide uniform and adequate longitudinal support under the pipe. All drainage pipe shall be supported in such a manner as to maintain its alignment, and prevent sagging. Blocking alone shall not be used to maintain pipe grading. Bell holes at each joint shall be provided to permit the joint to be assembled properly while maintaining uniform pipe support. A compacted depth of 100 mm to 150 mm is generally sufficient bedding thickness. Ledge or sharp rocks and clods which could damage the pipe cannot be used. In general, select pipe bedding shall consist of a non-cohesive ballast material of which at least 50% will pass a ¼ inch sieve and 100% will pass a ½ inch sieve, and that completely surrounds the pipe by a radial depth of at least 100 mm and that is sufficiently consolidated so that the intended earth loading will not produce further compaction.

A-7.3.5.4.(1) Freeze Protection.

Piping Exposed to Freezing

No water, soil, or waste pipes shall be installed on the exterior of a building or in the uninsulated side of an exterior wall, or in any place where they may be subjected to freezing temperatures, unless adequate provision is made to protect such pipes from freezing (such as applying trace wires or insulation).

- a10.1 The Thermal Insulation Association of Canada (TIAC) “Mechanical Insulation Best Practices Guide” 2013 edition is a comprehensive source of information on the selection, installation and proper use of thermal insulation materials. (Note that Section 4 of this Guide is not included in the scope of this Appendix Note as it contains information on proprietary products, which are not within the mandate of the Code.)

Insulation of Buried Piping

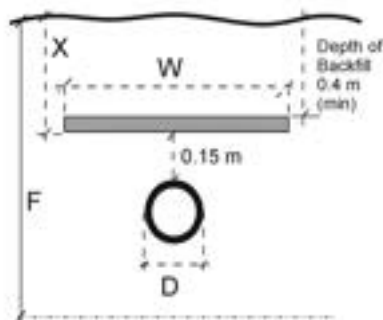
Failures in buried pipe are caused by improper installation, corrosion, poor design, soil movement caused by freeze-thaw situations, to name some of the causes. Designing for frost protection is a consideration in Ontario because all regions experience winter conditions, where temperatures drop below freezing, and it is impractical to bury piping below the depth of frost penetration, insulation may be used to protect the pipe from freezing temperatures.

There are two methods available:

- (1) insulation is formed to fit around and encapsulate the pipe, or
- (2) a sheet of insulation at some level above the buried pipe.

The type of backfill that is used to bury pipe is most important because this determines how the frost will pass through the backfill and penetrate the buried pipe.

Typical Water Pipe Protection by Horizontal Insulation



The width of a sheet of insulation may be calculated using the following formula: Width of Insulation:

$$W = D + 2 (F-X) - 0.3$$

Where:

- W = Width of Insulation (m)
 D = Outside Diameter of Pipe (m)
 X = Insulation Depth (m)
 F = Estimated Frost Depth (m)

Having calculated the width of the insulation, the thickness can be found on a chart, similar to the one shown below.

		Thickness of Foam Insulation, mm						
		Design Freezing Index (°C-Days)						
		850	1 125	1 400	1 675	1 950	2 225	2 500
Amount of Backfill over the Insulation, m	0.6	50	65	75	90	100	115	125
	0.9	40	50	65	75	90	100	115
	1.2	25	40	50	65	75	90	100
	1.5	25	25	40	50	65	75	90
	1.8	25	25	25	40	50	65	75
	2.1			25	25	40	50	65
	2.4				25	25	40	50
	2.7					25	25	40
	3.0						25	25
Column 1	2	3	4	5	6	7	8	9

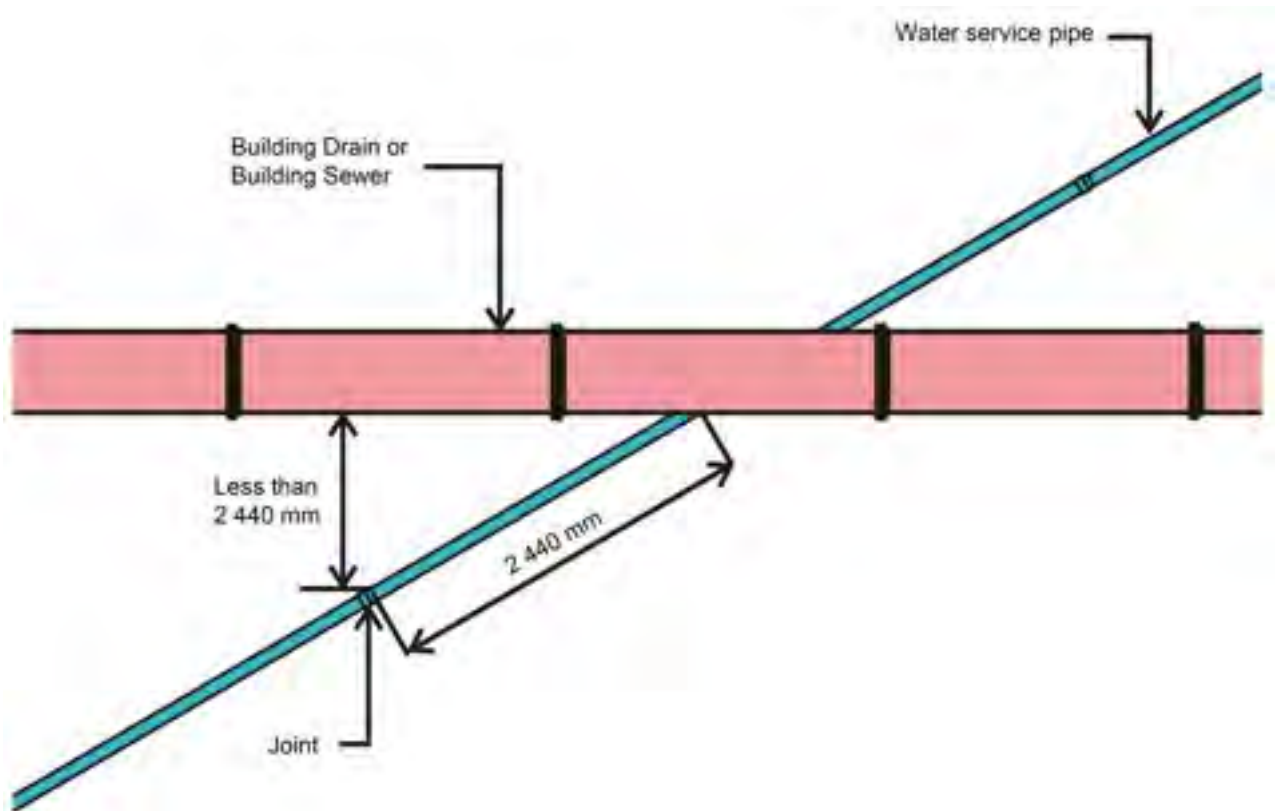
A-7.3.5.7. Spatial Separation.

The provisions of this Article are intended to limit the probability that failure of an in-ground building drain or building sewer would lead to the contamination of potable water in a water service pipe.

Sentence (1) requires that a minimum 2 440 mm horizontal clearance be provided between a water service pipe and a building drains or a building sewer.

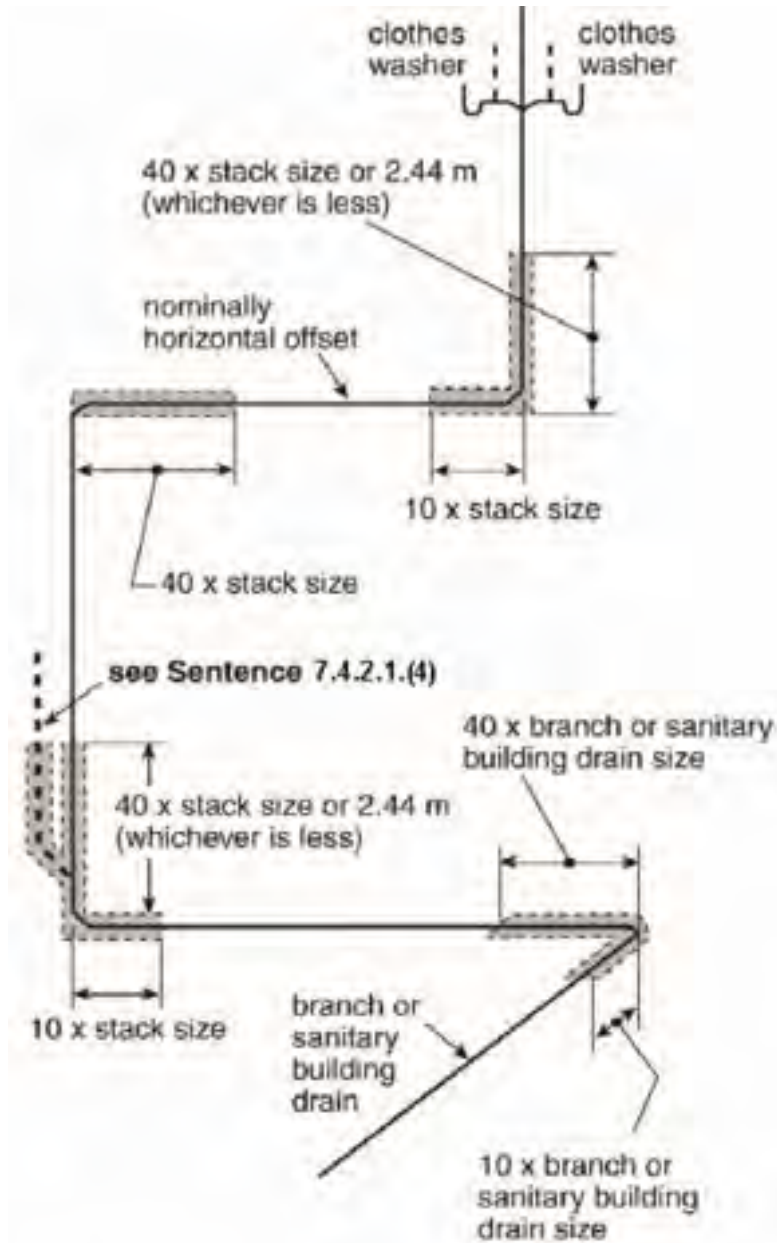
Sentence (2) describes certain exceptions which would permit the water service pipe to be closer than 2 440 mm to the building drain or building sewer.

Sentence (3) recognizes that in certain instances, the water service pipe and a building drain or building sewer may have to cross each other. In this case, the greatest risk of contamination to the potable water is through joints in the water service pipe under backflow conditions. In order to avoid this, the Code requires that there be no joints in the water service pipe within 2 440 mm horizontally of the intersection with the building drain or building sewer. The illustration below appears to meet this requirement, however it is intended that no joints in the water service line be located within 2 440 mm of the closest point on the building drain/sewer.



A-7.4.2.1.(4) Suds Pressure Zones.

High sudsing detergents used in clothes washers produce suds that tend to disrupt the venting action of the venting systems and can also spread through the lower portions of a multi-storey drainage system. The more turbulence, the greater the suds. One solution that avoids the creation of suds pressure zones involves connecting the suds-producing stack downstream of all other stacks and increasing the size of the horizontal building drain to achieve a greater flow of air and water. Using streamlined fittings, such as wyes, tends to reduce suds formation. Check valves or backwater valves in fixture outlet pipes have also been used to correct problem installations.



A-7.4.3.3.(1) Waste with Organic Solids.

Equipment such as garbage grinders and potato peelers produces waste with organic solids. These devices reduce most waste into small particles that will flow easily through the drainage system. However, if they are located upstream of the interceptor, the particles could block the interceptor.

A-7.4.4.2.(1) Protection for Drainage System.

When the temperature of the heated discharge exceeds 75°C, the material being used shall be used in accordance with the manufacturer's approval and done in accordance with the manufacturer's instructions. Where the material being used is a thermoplastic, care should be taken with discharges above 55°C.

A-7.4.4.3.(1) Grease Interceptors.

For large volume engineered interceptors, the drain down time may vary. Further information on the design and sizing of grease interceptors can be found in the ASPE 2008 Data Book, Volume 4, Chapter 8, "Grease Interceptors."

A-7.4.4.4.(1) Bio-Hazardous Waste.

Chemically loaded and bio-hazardous wastes can be dangerous to private and public sewer systems and hazardous to people. The treatment of corrosive and acid waste is mandated by this Code.

The treatment of chemically loaded effluents is usually regulated by sewage collecting and treatment authorities. The treatment of bio-hazardous waste should follow good engineering practice, such as that described in the Laboratory Biosafety Guidelines published by Health Canada. Bio-hazardous waste disposal systems require specific engineering expertise and remain outside the scope of this Code.

A-7.4.6.3. Arrangement of Piping at Sump.

In most installations, controls will be installed in conjunction with a float to automatically empty the sump. If such controls are not provided, the capacity of the sump should equal the maximum inflow to the sump that is expected to occur during any 24 h period.

A-7.4.6.4. Protection from Backflow Caused by Surge.

These requirements are intended to apply when, in the opinion of the local authority having jurisdiction, there is danger of backup from a public sewer.

A-7.4.7.1.(1) Cleanouts for Fixture Drains.

A trap cleanout plug is not acceptable as a cleanout for the fixture drain; hence, either a separate cleanout or a trap with a removable trap dip must be installed.

A-7.4.7.1.(6) Cleanouts for Drainage Systems.

To accommodate the limitations of sewer cleaning equipment, the cleanout should be located as close as possible to the exterior wall of the building, either inside or outside, and be accessible for sewer cleaning equipment.

A-Table 7.4.9.3. Hydraulic Loads.

Bathroom Group

A bathroom group is considered to consist of 1 water closet, 1 lavatory, and 1 bathtub (with or without shower head) or a shower stall.

Hydraulic Loads for Laundry Traps

When determining the hydraulic load on a pipe, no allowance need be made for a load from a domestic clothes washer when discharged into a laundry tray, since the hydraulic load from the laundry tray is sufficient.

Hydraulic Loads for Floor Drains

No hydraulic load is required from a floor drain in a washroom since it is for emergency use only.

A-7.4.10.4.(1) Rainfall Intensities.

Climate information on rainfall intensities for various localities is found in MMAH Supplementary Standard SB-1, "Climatic and Seismic Data".

When calculating the hydraulic load from a roof or paved surface, it should be noted that a 1 mm depth of water on 1 m² of surface is equivalent to 1 L.

A-Table 7.4.10.5. Conversion of Fixture Units.

The following table expands Table 7.4.10.5.:

Maximum Probable Drainage Rate, gal/min

Fixture Units in Service	Fixture Units Col. 1	Fixture Units Col. 1 x 10	Fixture Units Col. 1 x 100
10	21	53	174
11	23	55	183
12	24	57	192
13	24	59	201
14	25	61	210
15	25	63	219
16	26	65	228
17	26	67	237
18	27	69	246
19	27	71	254
20	27	72	262
21	28	74	271
22	29	75	280
23	29	77	289
24	30	78	298
25	30	80	307
26	31	82	316
27	31	83	325
28	32	85	334
29	32	86	342
30	33	88	350
31	33	90	359
32	34	91	368
33	34	92	377
34	35	94	386
35	35	95	395
36	36	96	403
37	36	98	411
38	37	99	419
39	37	100	427
Column 1	2	3	4

Fixture Units in Service	Fixture Units Col. 1	Fixture Units Col. 1 x 10	Fixture Units Col. 1 x 100
40	38	102	435
41	38	103	444
42	39	104	453
43	39	106	462
44	39	107	471
45	40	108	480
46	40	110	488
47	40	111	496
48	41	112	504
49	41	114	512
50	41	115	520
51	42	116	528
52	42	118	536
53	42	119	544
54	43	120	552
55	43	122	560
56	43	123	568
57	44	124	576
58	44	126	584
59	44	127	592
60	44	128	600
61	45	129	608
62	45	130	616
63	45	131	624
64	45	133	632
65	46	134	640
66	46	135	648
67	46	136	656
68	46	138	664
69	47	139	672
Column 1	2	3	4

Fixture Units in Service	Fixture Units Col. 1	Fixture Units Col. 1 x 10	Fixture Units Col. 1 x 100
70	47	140	680
71	47	141	687
72	47	143	694
73	48	144	701
74	48	145	708
75	48	147	715
76	48	148	722
77	49	149	729
78	49	151	736
79	49	152	743
80	49	153	750
81	50	154	759
82	50	155	768
83	50	156	777
84	50	157	786
85	50	159	795
86	51	160	803
87	51	161	811
88	51	162	819
89	51	163	827
90	51	164	835
91	52	165	842
92	52	166	849
93	52	167	856
94	52	168	863
95	52	169	870
96	53	170	876
97	53	171	882
98	53	172	888
99	53	173	894
100	53	174	900
Column 1	2	3	4

A-Table 7.4.10.8. Minimum Slope of Horizontal Drain.

Although slopes below 1 in 100 are permitted for pipes over 4 inches, they should be used only where necessary. Steeper slopes and higher velocities will help to keep pipes clean by moving heavier solids that might tend to clog the pipes.

A-7.5.6.2. Vent Pipe Connections.

Except for wet venting, fittings used to connect vent pipes to nominally horizontal soil-or-waste pipes are specified in Subsection 7.2.4.

A-7.6.1.3.(6) Identification of Underground Non-Metallic Pipe.

Metallic piping may be used to extend underground non-metallic water supply piping above the floor. In these cases, the metallic pipe extension should not be used for electrical grounding purposes. Therefore, it is advisable to post a permanent sign indicating “plastic piping underground - do not use for electrical grounding purposes” in a conspicuous location.

A-7.6.1.6.(1) Residential Suites.

Where multiple risers convey the water supply to dwelling units, each dwelling unit’s water distribution system shall be provided with a shut-off valve located immediately where the water piping enters the suite so as to isolate the fixtures as well as the water distribution piping serving the dwelling unit’s fixtures. Fixture stopcocks or shut-off valves located immediately adjacent to a fixture may not be adequate to protect the water distribution piping. Where a residential suite is served by a single shut-off valve on the water supply, additional shut-off valves may be required to achieve compliance with Sentences 7.6.1.5.(1) and 7.6.1.8.(1).

A-7.6.1.10.(1) Check Valves.

When a check valve is required by Sentence 7.6.1.10.(1), or a backflow preventer by Articles 7.6.2.2., 7.6.2.3. or 7.6.2.6. or a pressure reducing valve by Article 7.6.3.3., protection against thermal expansion may be required.

A-7.6.1.12. Relief Valves.

A relief valve shall not be routed through or discharge to an area where freezing temperatures may occur.

If the discharge piping is longer than 2 m or more than two 90° elbows are used, the valve manufacturer’s installation instructions should be followed to ensure that the piping does not affect the relief valve’s discharge capacity.

A-7.6.1.14.(1) Water Hammer Prevention.

Water hammer is a build-up of pressure in a length of horizontal or vertical pipe which occurs when a valve or faucet is closed suddenly. The longer the pipe and the greater the water velocity, the greater the pressure exerted on the pipe, which can be many times the normal static water pressure and be sufficient to burst the pipe. Ordinary kitchen and bathroom faucets can be closed quickly enough to cause water hammer even with relatively low water pressure in the pipe.

Means of preventing water hammer should be installed wherever there are valves or faucets, particularly where they are at the end of long lengths of pipes. This may be done by installing either water hammer arresters which are manufactured for the purpose or air chambers installed vertically that are fabricated from pieces of piping with a closed upper end and connected to the end of the horizontal or vertical run of pipe.

The air chamber should be 300 to 450 mm long if made from the same size pipe as the water pipe it serves. If the chamber is made from a pipe with larger diameter than the water pipe, its length can be reduced accordingly

Air chambers should be accessible if they are the manufactured type with top air valve and a stop-and-waste valve or are of the diaphragm type.

A-7.6.1.16.(1) Thermal Expansion.

To accommodate the increase in pressure caused by thermal expansion within a closed water system, one of the following should be installed:

- (a) a suitably sized diaphragm expansion tank designed for use within a potable water system,
- (b) an auxiliary thermal expansion relief valve (T.E.R. valve) conforming to CAN/CSA-B125.3, “Plumbing Fittings”, set to a pressure of 550 kPa or less and designed for repeated use, or
- (c) other means acceptable to the authority having jurisdiction.

A-7.6.2.5. Backflow from Buildings with a Solar Domestic Hot Water System.

The Building Code regulates where a backflow preventer is required. Articles 7.6.2.1. and 7.6.2.2. require protection of potable water systems against contamination due to reversal of the normal direction of flow between a potable water system and any other system containing non-potable water or substances, where there is a direct connection between the two systems.

Consequently, a backflow prevention device is required in a solar domestic hot water (SDHW) system only where there is a direct connection between the building's potable water make-up supply and the solar heat transfer loop containing non-potable fluids. Where a non-potable heat transfer loop is charged with potable water through a charging port that is not permanently connected to a potable water system, the temporary connection to the potable water system shall include a backflow preventer or an air gap.

Equipment forming part of a packaged system for solar heating of potable water must conform to CAN/CSA-F379.1, "Packaged Solar Domestic Hot Water Systems (Liquid-to-Liquid Heat Transfer)". The installation of packaged systems for solar heating of potable water in residential occupancies must be in conformance with CSA F383, "Installation of Packaged Solar Domestic Hot Water Systems". All other systems must be installed in accordance with good engineering practice and are expected to comply, where applicable, with the same practices required for package systems.

According to Clause 7.4.3.1. of CAN/CSA-F379.1, a SDHW system that utilizes a single-wall heat exchanger is required to contain a relatively harmless heat transfer fluid (which may present minor to moderate hazard) and be properly labelled. In this case, a permanent backflow prevention device would be required on the charging line between the potable water system and the heat transfer loop only if there is a permanent direct connection between the heat transfer loop and the potable water system. Otherwise, the Building Code does not require backflow prevention devices on the domestic hot or cold potable water lines. In case of a conflict between the provisions of the Building Code and the standard, the provisions of the Building Code govern.

Similarly, where a SDHW system has a double-wall heat exchanger and there is a permanent direct connection between the heat transfer loop and the potable water system, the selection of the required backflow preventer would be determined in accordance with Sentence 7.6.2.3.(1), based on the type of heat transfer fluid used and other risks.

The requirement for premise isolation would be determined based on the use and the occupancy of the entire building. In most cases, the installation of a domestic solar hot water system that has a direct connection to a potable water system, alone, would not require the premise isolation referenced in Sentence 7.6.2.6.(1).

"Relatively harmless" as defined in CAN/CSA-F379.1, "Packaged Solar Domestic Hot Water Systems (Liquid-to-Liquid Heat Transfer)" as a fluid having an oral LD50 of 15 000 mg/kg or greater, in accordance with Toxicity Class 6 (relatively harmless) of the Hodge and Sterner scale. The Hodge and Sterner scale is a toxicity scale recognized by the Canadian Centre for Occupational Health and Safety that provides ratings from 1 (extremely toxic) to 6 (relatively harmless) based on the LD50 approach for oral administration. LD stands for "Lethal Dose". LD50 is the amount of a material, given all at once, which causes the death of 50% (one half) of a group of test animals. The LD50 is one way to measure the short-term poisoning potential (acute toxicity) of a material.

Information is published in the material safety data sheets supplied with all heat-transfer fluid shipments, as required by Canadian law.

A-7.6.2.6. Locations Requiring Premise Isolation.

The following list is a guide to locations where premise isolation may be considered a moderate hazard:

- shopping malls
- multi-unit residential
- office buildings
- pleasure boat marinas
- schools and colleges

The following list is a guide to locations where premise isolation may be considered a severe hazard:

- hospital buildings with operating, mortuary or laboratory facilities
- radioactive material processing plants
- petrochemical processing facilities
- premises where inspection is restricted
- sewage treatment plants
- commercial laundries (excluding laundromats)
- plating or chemical plants

- docks and dockside facilities
- food and beverage processing plants
- steam plants
- trackside facilities for trains

An assessment of the hazard must be carried out to determine the need, if any, for a backflow prevention device.

A-7.6.2.8.(1) Flushing and Disinfecting Water Service Pipes.

Water service pipes of 100 mm in size or larger shall be flushed and disinfected. Flushed sections shall be protected from contamination.

After flushing is completed, water from the existing distribution system shall be allowed to flow at a controlled rate into the new piping. Liquid chlorine solution shall be introduced so that the chlorine is distributed throughout the section being disinfected. The chlorine shall be applied so that the chlorine concentration is 50 mg/L minimum throughout the section. Then the system shall be left charged with 50 mg/L chlorine solution for 24 hours.

Test the chlorine residual piping after 24 hours. If tests indicate a chlorine residual of at least 25 mg/L, the section shall be flushed completely and recharged with water normal to the operation of the system. If the test does not meet the requirements, the chlorination procedure shall be repeated until satisfactory results are obtained. After the system has been recharged, take samples for bacteriological tests. If there is indication of contamination, the disinfection procedure shall be repeated. The system shall not be put into operation until clearance has been given by the inspector appointed by the chief building official.

A-7.6.3.1.(2) Design of Potable Water Systems.

The design procedures contained in the following documents are considered good engineering practice in the field of potable water systems:

- (a) 2011 ASHRAE Handbook of HVAC Applications, Chapter 50, "Service Water Heating",
- (b) 2009 ASHRAE Handbook of Fundamentals, Chapter 22, "Pipe Sizing",
- (c) 2005 ASPE Data Book - Volume 2, Chapter, 5, "Cold Water Systems", and
- (d) 2005 ASPE Data Book - Volume 2, Chapter, 6, "Domestic Water Heating Systems Fundamentals". Alternative procedures shown below are also acceptable.

Table A-7.6.3.1.
Pipe Size Based on the Number of Fixtures Units Served⁽¹⁾

Water Service, inches	Water Distribution System, inches	Maximum Allowable Length, m														
		12	18	24	30	46	61	76	91	122	152	183	213	244	274	305
Pressure Range		Number of Fixture Units Served														
200 to 310 kPa (30 to 45 psi)																
¾"	½"	6	5	4	3	2	1	1	1	0	0	0	0	0	0	0
¾"	¾"	18	16	14	12	9	6	5	5	4	4	3	2	2	2	1
¾"	1"	29	25	23	21	17	15	13	12	10	9	7	6	6	6	6
1"	1"	36	31	27	25	20	17	15	13	12	10	8	6	6	6	6
1½"	1¼"	90	68	57	48	38	32	28	25	21	18	15	12	12	11	11
1½"	1½"	151	124	105	91	70	57	49	45	36	31	26	23	21	20	20
2"	1½"	151	151	132	110	80	64	53	46	38	32	27	23	21	20	20
2"	2"	359	329	292	265	217	185	164	147	124	96	70	61	57	54	51
2½"	2½"	445	418	390	370	330	300	280	265	240	220	198	175	158	143	133
311 to 413 kPa (46 to 60 psi)																
¾"	½"	8	7	6	5	4	3	2	2	1	1	1	0	0	0	0
¾"	¾"	21	21	19	17	14	11	9	8	6	5	4	4	3	3	3
1"	1"	42	42	41	36	30	25	23	20	18	15	12	10	9	8	8
1½"	1¼"	83	83	83	83	66	52	44	39	33	29	24	20	19	17	16
1½"	1½"	151	151	151	151	128	105	90	78	62	52	42	38	35	32	30
2"	1½"	151	151	151	151	150	117	98	84	67	55	42	38	35	32	30
2"	2"	359	359	359	359	359	318	280	250	205	165	142	123	110	102	94
2½"	2½"	611	611	610	580	535	500	470	440	400	365	335	315	285	267	250
Over 413 kPa (60 psi)																
¾"	½"	8	8	7	6	5	4	3	3	2	1	1	1	1	1	0
¾"	¾"	21	21	21	21	17	13	11	10	8	7	6	6	5	4	4
1"	1"	42	42	42	42	38	32	29	26	22	18	14	13	12	12	11
1½"	1¼"	83	83	83	83	83	74	62	54	43	34	26	25	23	22	21
1½"	1½"	151	151	151	151	151	151	130	113	88	73	51	51	46	43	40
2"	1½"	151	151	151	151	151	151	142	122	98	82	64	51	46	43	40
2"	2"	359	359	359	359	359	359	359	340	288	245	204	172	153	141	129
2½"	2½"	611	611	611	611	611	611	610	570	510	460	430	404	380	356	329
Column 1	2	3	4	5	6	7	8	9	10	11	12	13	14	15	16	17

Notes to Table A-7.6.3.1.:

(1) Where total fixture unit values exceed those given in this Table, the system must be designed according to a detailed engineering design method.

a5.1 A-7.6.3.4.(5) Water System Pipe Size.

Where separate water service piping connects into private water supply piping, the private water supply piping will be governed by Article 7.1.5.5.

a10.1 A-7.6.4.1.(3) and (5) Automatic Shut-off of Water Flow.

Examples of water shut-off devices include occupant sensors and self-closing valves.

a10.1 A-7.6.4.1.(4) Automatic Compensating Valves.

When replacing a shower head, the appropriate shower valve with a suitable compensating feature matching the flow rate should be chosen to decrease the possibility that users will suffer thermal shock. The water flow rate of automatic compensating mixing valves can be found in ASSE 1016 / ASME 112.1016 / CSA B125.16, "Performance Requirements for Automatic Compensating Valves for Individual Showers and Tub/Shower Combinations".

e6 A-7.6.4.2.(4) Plumbing Fixtures.

Heritage buildings including homes, may contain sanitary drainage piping that is sized in accordance with the flush cycle of period plumbing fixtures. Operational difficulties may be encountered when these fixtures are replaced with one having a lower flush cycle.

A-7.6.5. Hot Water Temperature.

Hot water delivered at 60°C will severely burn human skin in 1 to 5 seconds. At 49°C the time for a full thickness scald burn to occur is 10 minutes. Children, the elderly and persons with disabilities are particularly at risk of scald burns. Compliance with Article 7.6.5.2. will reduce the risk of scalding in showers and bathtubs and reduce the risk of thermal shock in wall mounted showers. Devices installed to achieve compliance must conform to the applicable standard referenced in the Code.

Since a scald risk also exists at other fixtures, such as lavatories, sinks and bathtubs, the water outlet temperature at those fixtures is addressed by Articles 7.6.5.1. and 7.6.5.3.

A-8.1.3.1.(1) Sanitary Sewage.

Sanitary sewage of domestic origin is as described in (b) of the definition in Sentence 1.4.1.2.(1) of Division A. The addition of public swimming pool drainage to the definition of sanitary sewage is not intended to allow the discharge of the pool drainage water to an on-site sewage system.

A-8.1.3.1.(3) Evaluation of Waste from Industrial Processes.

When evaluating whether industrial process waste can go to an on-site sewage system, the total contaminant levels in the whole waste stream must be looked at. Heavy metals, pesticides and solvents are not found in domestic sewage and those levels must be brought down if present. The BOD₅ and suspended solids should be consistent with the levels found in domestic sanitary sewage. Slaughterhouses and milking operations have wastes that are similar to domestic sewage in chemical composition, but are characterized by high organic, highly nitrogenous and biologically degradable suspended and dissolved solids and grease in high concentrations. These wastes are not suitable for discharge to an on-site sewage system.

A-8.2.1.2.(1) Site Evaluation Information.

The evaluation required in Sentence (1) usually includes at least the following and is required on permit application

- (a) date the evaluation was done,
- (b) name, address, telephone number, and signature of the person who prepared the evaluation,
- (c) a scaled plan of the site showing
 - (i) the legal description of the property, property lines and easements,
 - (ii) the location of items in Column 1 of Tables 8.2.1.6.A. and 8.2.1.6.B.,
 - (iii) the proposed location of the sewage system,
 - (iv) the location of any unsuitable, disturbed or compacted areas, and
 - (v) the access route for tank maintenance,

- (d) depth to bedrock,
- (e) evidence of high ground water,
- (f) soil properties,
- (g) soil conditions,
- (h) utility corridors,
- (i) permeability, and
- (j) potential for flooding.

A-8.2.1.2.(2) Alternative Tests.

Other tests to determine percolation time may be suitable depending on the soil type(s) encountered on a site. The results of tests other than those described in this Code may be used by relying on provisions governing the use of alternative solutions (such as Clause 1.2.1.1.(1)(b) of Division A).

A-8.2.1.2.(3) Test Procedure.

Where a field percolation test is required, it is performed in the following manner:

- (a) Make an excavation in the soil layer which is to be assessed for a percolation time. The excavation shall be:
 - (i) between 100 and 300 mm in diameter
 - (ii) be at least 200 mm in depth below the upper level of the soil layer being assessed.
- (b) All loose material and smeared clay shall be removed from the sides and bottom of the excavation.
- (c) Cover the bottom of the excavation with 50 mm of sand or fine gravel.
- (d) Fill the hole with water to a depth of 300 mm (or to the surface) and determine the time it takes for the water to seep away; repeat, and if the second filling seeps away in 10 minutes or less proceed as follows:
 1. Establish a fixed reference point, add water to a depth of 150 mm above the sand or fine gravel, and measure the water drop every 10 minutes for one hour. If for one hour the first 150 mm seeps away in 10 minutes or less, use a shorter time interval between readings.
 2. Refill to the 150 mm level when necessary and start another series of readings. Continue readings until the last two series of readings show a similar drop pattern (approximately equal drop in the same number of readings) or, alternatively, until the difference in the maximum and minimum drops in 3 consecutive readings is less than 5 mm. In either case use the average drop of the last 3 readings in computing "T"
- (e) If the initial fillings to 300 mm take more than 10 minutes to seep away, follow with this procedure:
 1. Maintain at least 300 mm of water in the hole for at least 4 hours, or until the soil being tested has become swollen and saturated with water. At least 12 hours should be allowed for swelling in clay soils, although dry clay soils may require longer periods to obtain a stabilized percolation rate.
 2. After swelling remove any loose material from the top of the sand or fine gravel.
 3. Using a fixed reference point, adjust the water level to 150 mm above the sand or gravel and measure the water drop every 30 minutes for four hours or until a stable rate of drop is reached. If the first 150 mm seeps away in less than 30 minutes, use a 10 minute interval and run the test for one hour or until the drop rate is stabilized. A drop of 5 mm or less in a 30 minute interval is indicative of a soil of "T" close to or greater than 50 min/cm. If it is to be assessed increase the reading interval to 60 minutes.
 4. Refill with water to the 150 mm level when necessary. Take readings until a stable rate of drop is reached. This may be when the drop in two successive readings does not vary by more than 1.5 mm or when the difference between the maximum and minimum readings of the last four readings does not exceed 5 mm. Once a stable rate is reached use the average drop of the last 3 readings in computing the percolation time.
- (f)

$$\text{Percolation time} = \frac{\text{Time Interval (minutes)}}{\text{Average drop of last 3 readings (cm)}}$$

A-8.2.1.3.(1) and (2) Balancing Tanks.

Where variable daily flows or peak flows occur, the flows to the sewage system may be balanced. The sewage system and any pump(s) that are installed to move the sanitary sewage, should be sized to accommodate a daily design sanitary sewage flow at least equal to the average daily sanitary sewage flow for the week. Balancing tanks should be sized in accordance with good engineering practice to ensure that peak flows can be accommodated.

A-8.2.1.4. Clearance Requirements.

Where coarse natural soils exist it may be necessary to require greater clearance distances to wells or surface water than those listed in the Tables. This is of greater importance when applied to the shoreline properties of sensitive lakes, where it is desired to prevent phosphates from entering the lakes.

a7 A-8.6.2.2. Other Treatment Units.

Article 8.6.2.2. sets out the acceptable solution to achieve Building Code compliance for residential treatment units. Sentences (1) and (2) of Article 8.6.2.2. are the performance requirements that set out the maximum concentrations of suspended solids and CBOD5 for different classifications of treatment units.

As set out in Sentence (5), treatment units that are certified to CAN/BNQ 3680-600, “Onsite Residential Wastewater Treatment Technologies” using a temperature condition listed under option a) or b) of Clause 8.2.2. of that standard are deemed to comply with the requirements of Sentences (1) and (2).

CAN/BNQ 3680-600 uses slightly different terminology than the Building Code. Note (1) to Table 8.6.2.2., which forms part of Sentences 8.6.2.2. (1) and (2), states that the classifications of treatment units specified in Column 1 correspond to the levels of treatment described in CAN/BNQ 3680-600. A Building Code Level II treatment unit corresponds to a treatment Class B-II in CAN/BNQ 3680-600, a Level III corresponds to Class B-III, and Level IV corresponds to a Class B-IV.

CAN/BNQ 3680-600 -2009 requires:

- 12 continuous months of testing in a climate representative of Ontario conditions as specified in Annex B.3. of the standard
- A minimum of weekly sampling
- 30-day average concentrations in treated effluent that do not exceed the maximum concentrations set out in Table 8.6.2.2.
- A minimum of 80% of sample results that do not exceed the maximum concentrations set out in Table 8.6.2.2.
- Influent wastewater quality that meets the requirements described in Table 5 of the standard
- Influent wastewater temperature that is:
 - Non-controlled, or
 - Controlled so that the influent wastewater is heated to no more than $11^{\circ}\text{C} \pm 1^{\circ}\text{C}$,
- Hydraulic loading as specified in Clause 8.2.2.1. of NSF/ANSI Standard 40 and Annex B.4.2.2. of the standard
- Stress loading in accordance with the procedures outlined in CAN/BNQ 3680-600, which includes wash-day stress, power/equipment failure stress, and working parent stress.

Installation of a CAN/BNQ 3680-600 certified residential treatment unit provides a clear and direct method of demonstrating compliance with the effluent quality criteria in Sentences (1) and (2). No further information is required by a principal authority to determine compliance with the effluent quality criteria in Sentences (1) and (2) of this provision.

It is also possible to achieve compliance for residential treatment units which do not have BNQ certification as Sentences (1) and (2) establish performance requirements.

If a residential treatment unit has not been certified to CAN/BNQ 3680-600, the treatment unit must be designed so that the effluent does not exceed, for the level of the treatment unit set out in Column 1 of Table 8.6.2.2., the maximum concentrations set out in Column 2 and 3 of Table 8.6.2.2. The treatment unit would need to be designed so that the effluent will not exceed the maximum concentrations in climatic conditions in the part of Ontario in which the system is to be installed.

The building permit applicant would need to demonstrate to the principal authority that the treatment unit complies with Sentences (1) and (2) for the particular climatic conditions where the unit would be used. It is the responsibility of the principal authority to review and determine compliance to the level of treatment required by Sentences (1) and (2).

Compliance would typically be demonstrated by providing the principal authority with test methods, engineering reports and other relevant documentation similar to that described above for CAN/BNQ 3680-600. Documents that could assist with demonstrating compliance could include:

- name of accredited testing organization,
- trade name of the on-site residential wastewater treatment technology being tested,
- the hydraulic capacity of the treatment unit,
- stress loading in accordance with the procedures outlined in standards such as CAN/BNQ 3680-600,
- the specific model and configuration chosen for the testing, and a comparison to the specific model and configuration being proposed in the permit application and associated scaling factors,
- installation, operation and maintenance manuals,
- the dates of testing and a summary of the results of the tests for all appropriate parameters for the type of treatment for the minimum duration of 12 continuous months, including but not limited to influent and effluent wastewater characteristics such as temperature and pH, number of samples, median, standard deviation, minimum and maximum, and
- an engineering letter, sealed and stamped.

CAN/BNQ 3680-600 only applies to residential systems. For non-residential onsite sewage systems that include treatment units, the applicant would need to demonstrate compliance with Sentences (1) and (2) of Article 8.6.2.2. Non-residential treatment units, therefore, must follow the second approach described above because BNQ certification is only available for residential treatment units. Compliance would typically be demonstrated by providing the principal authority with similar information as noted above.

a7 A-8.6.2.2.(5) Temperature Conditions for Testing of Treatment Units.

The temperature options that apply to the testing of treatment units which are certified to BNQ 3680-600 standard are referenced in Sentence 8.6.2.2.(5) of the Code and are set out in option a) and option b) of Clause 8.2.2. of the BNQ standard as follows:

- (a) non-controlled temperature
- (b) controlled temperature so that the influent wastewater is heated to $11^{\circ}\text{C} \pm 1^{\circ}\text{C}$, whenever necessary to assure a minimum temperature of 10°C .

Note - this option is based on a temperature of 10°C , which is a typical temperature at the outlet of the septic tank and, as well, it is required for testing nitrogen reduction treatment technologies.

Additional treatment options that are available in this standard, but are not currently required by the Building Code, are as follows:

Class of Treatment	Fecal Coliforms or E. Coli (CFU/100 mL) ⁽¹⁾
D-I	50 000
D-II	200
D-III	ND ⁽²⁾

Notes to Table:

- (1) Maximum concentration in CFU/100 mL based on 30 day average.
- (2) ND means non-detectable (median < 10 CFU/100 mL)

Class of Treatment	Total Phosphorus ⁽¹⁾ , mg/L	Total Nitrogen Reduction
P-I	1.0	—
P-II	0.30	—
N-I	—	50%
N-II	—	75%

Notes to Table:

(1) Maximum concentration in mg/L based on 30 day average.

A-8.7.4.2.(1) Fill Material.

Any leaching bed fill added to meet the requirements of 8.7.4.2.(1) shall be regarded as part of the sewage system and this fill must be contained on the lot or parcel of land in which the sewage system is located.

A-8.7.5.3.(2) Spacing of Distribution Pipes.

In order to evenly apply the effluent when a filter bed is used, the maximum spacing of distribution pipes should not be greater than 1.2 m.

A-8.7.6.1. Trench Construction.

Care must be taken when constructing a shallow buried trench system. Soils have to be dry and protected to ensure smearing of the trench does not take place. If smearing does take place additional measure will need to be undertaken to ensure that the permeability of the soil is not affected in the trench.

a3 A-8.7.7.1.(5) Extension of Sand Layer.

Where the underlying soil has a percolation time greater than 15 minutes, Sentence (5) requires the sand layer described in Sentence (4) be extended 15 m beyond the perimeter of the treatment unit in any direction that the effluent may move horizontally. Consideration may be given to whether the top 300 mm of native soil has the properties required in Sentence (4) prior to removing the existing soil and replacing with sand.

This would also apply to the additional loading area required in Clause (5)(b) of QT/400.

a3 A-8.7.7.1.(8) Open Bottom Treatment Units.

Where an open bottom treatment unit is used in conjunction with a Type A dispersal bed, the placement of the unit is important to achieve even distribution and consideration may be given to the following:

- 1) the treatment unit is placed in the centre of the stone layer where the topography is flat, or
- 2) uphill of the centre of the stone layer on sloping topography.

A-8.7.8.3. Type B Dispersal Beds.

The design of a Type B dispersal bed may be based on the use of Table 2-8 of the BCMOH Sewerage System Standard Practice Manual. The Building Code requires the effluent to be of Level IV effluent for a Type B dispersal bed. The loading rates to be used pertain to Type 2 effluent within Table 2-8. The percolation time given in this Table is in min/2.54 cm (inch) not min/cm and must be converted by dividing by 2.54.

A-9.1.1.9. Factory-Built Buildings.

Manufactured buildings intended for residential occupancy must comply with all appropriate Code requirements. Only those building components that are designed and constructed in manufacturing plants in accordance with the specified standards (CSA Z240.2.1 and CSA A277) are deemed to comply with the Code. Building components designed and constructed outside the place of manufacture (e.g. masonry chimneys, basement stairs, foundations, etc.) must conform to the requirements of the Code. The Code also applies to the site installation of manufactured buildings in terms of tie-down, spatial separation, grading, plumbing connections to street services, etc.

CSA standard CSA A277, “Procedures for Factory Certification of Buildings”, describes a procedure whereby an independent certification agency can review the quality control procedures of a housing factory and make periodic, unannounced inspections of its products and thus, through suitable labelling, provide assurance to authorities at the final site that the components that cannot be inspected on site comply with the code indicated on the label. It is not a building code, only a procedure for certifying compliance of factory-built components with a building code or other standard. If a factory-built house bears the label of a creditable certification agency indicating that compliance with the National Building Code has been certified using the A277 procedure, the accepting authority will have some assurance that the hidden components do not need to be inspected again on site.

a10.1 A-9.3.1.7. Ratio of Water to Cementing Material.

While adding water to concrete on site may facilitate its distribution through formwork, this practice can have several undesirable results, such as reduced strength, greater porosity, and more propensity to shrinkage cracking. The ratio of water to cementing material is determined according to weight. For example, using Table 9.3.1.7., the maximum water-cement ratio of 0.45 for a 20 mm coarse aggregate would require 18 kg (or 18 L) of water (1 L of water weighs 1 kg).

A-9.3.2.1.(1) Grade Marking of Lumber.

Lumber is generally grouped for marketing into the species combinations contained in Table A-9.3.2.1.(1)A. The maximum allowable spans for those combinations are listed in the span tables for joists, rafters and beams. Some species of lumber are also marketed individually. Since the allowable span for the northern species combination is based on the weakest species in the combination, the use of the span for this combination is permitted for any individual species not included in the Spruce-Pine-Fir, Douglas Fir-Larch and Hemlock-Fir combinations.

Facsimiles of typical grade marks of lumber associations and grading agencies accredited by the Canadian Lumber Standards (CLS) Accreditation Board to grade mark lumber in Canada are shown in Table A-9.3.2.1.(1)B. Accreditation by the CLS Accreditation Board applies to the inspection, grading and grade marking of lumber, including mill supervisory service, in accordance with CSA O141, “Softwood Lumber”. The grade mark of a CLS accredited agency on a piece of lumber indicates its assigned grade, species or species combination, moisture condition at the time of surfacing, the responsible grader or mill of origin and the CLS accredited agency under whose supervision the grading and marking was done.

**Table A-9.3.2.1.(1)A.
Species Designations and Abbreviations**

Commercial Designation of Species or Species Combination	Abbreviation Permitted on Grade Stamps	Species Included
Douglas Fir — Larch	D Fir — L (N)	Douglas Fir, Western Larch
Hemlock — Fir	Hem — Fir (N)	Western Hemlock, Amabilis Fir
Spruce — Pine — Fir	S — P — F or Spruce — Pine — Fir	White Spruce, Engelmann Spruce, Black Spruce, Red Spruce, Lodgepole Pine, Jack Pine, Alpine Fir, Balsam Fir
Northern Species	North Species	Any Canadian softwood covered by the NLGA Standard Grading Rules

Canadian lumber is graded to the NLGA Standard Grading Rules for Canadian Lumber, published by the National Lumber Grades Authority. The NLGA rules specify standard grade names and grade name abbreviations for use in grade marks to provide positive identification of lumber grades. In a similar fashion, standard species names or standard species abbreviations, symbols or marks are provided in the rules for use in grade marks.

Grade marks denote the moisture content of lumber at the time of surfacing. “S-Dry” in the mark indicates the lumber was surfaced at a moisture content not exceeding 19%. “MC 15” indicates a moisture content not exceeding 15%. “S-GRN” in the grade mark signifies that the lumber was surfaced at a moisture content higher than 19% at a size to allow for natural shrinkage during seasoning.

Each mill or grader is assigned a permanent number. The point of origin of lumber is identified in the grade mark by use of a mill or grader number or by the mill name or abbreviation. The CLS certified agency under whose supervision the lumber was grade marked is identified in the mark by the registered symbol of the agency.

Table A-9.3.2.1.(1)B.
Facsimiles of Grade Marks Used by Canadian Lumber Manufacturing Associations and Agencies
Authorized to Grade Mark Lumber in Canada






Facsimiles of Grade Mark	Association or Agency
	<p>Alberta Forest Products Association 500—10709 Jasper Avenue Edmonton, Alberta T5J 3N3 www.albertaforestproducts.ca</p>
	<p>Canadian Mill Services Association #200, 601—6th Street New Westminster, British Columbia V3L 3C1 www.canserve.org</p>
	<p>Canadian Softwood Inspection Agency Inc. 1047—250A Street Aldergrove, British Columbia V4W 2S8</p>
	<p>Central Forest Products Association Inc. c/o Reimer & Co., Chartered Accountants PO Box 146 Swan River, Manitoba R0L 1Z0</p>
	<p>Council of Forest Industries Southern Region: 360—1855 Kirschner Road Kelowna, British Columbia V1Y 4N7 Northern Region: 400—1488 Fourth Avenue Prince George, British Columbia V2L 4Y2 www.cofi.org</p>

Table A-9.3.2.1.(1)B. (Cont'd)
 Facsimiles of Grade Marks Used by Canadian Lumber Manufacturing Associations and Agencies
 Authorized to Grade Mark Lumber in Canada


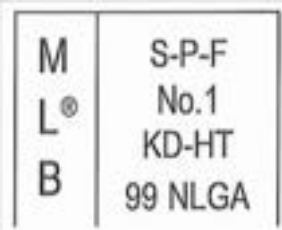
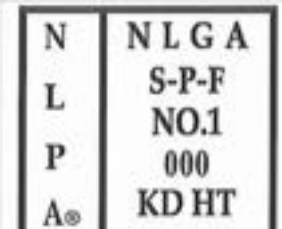






Facsimiles of Grade Mark	Association or Agency
	MacDonald Inspection Services Ltd. 842 Eland Drive Campbell River, British Columbia V9W 6Y8 www.gradestamp.com
	Maritime Lumber Bureau PO Box 459 Amherst, Nova Scotia B4H 4A1 www.mlb.ca
	Newfoundland and Labrador Lumber Producers Association P.O. Box 8 Glovertown, Newfoundland A0G 2L0 www3.nf.sympatico.ca/nllpa
	Northwest Territories Forest Industries Association PO Box 220 Fort Smith, Northwest Territories X0E 0P0
	Ontario Forest Industries Association (Home of CLA Grading and Inspection) 20 Toronto Street Suite 950 Toronto, Ontario M5C 2B8 www.ofia.com

Table A-9.3.2.1.(1)B. (Cont'd)
Facsimiles of Grade Marks Used by Canadian Lumber Manufacturing Associations and Agencies
Authorized to Grade Mark Lumber in Canada

Facsimiles of Grade Mark	Association or Agency
 <p>O.L.M.A.[®] 09 1 KD-HT NLGA S-P-F</p>	<p>Ontario Lumber Manufacturers' Association PO Box 97530 Toronto, Ontario M1C 4Z1 www.olma.ca</p>
 <p>PIB[®] NO. 1 KD - HT S-P-F 00 NLGA RULES</p>	<p>Pacific Lumber Inspection Bureau 1010 S. 336th Street Suite 300 Federal Way, Washington 98003 USA British Columbia Division: P.O. Box 19118 Fourth Avenue Postal Outlet Vancouver, British Columbia V6C 4R8 www.plib.org</p>
 <p> S-P-F KD-HT 1 477 NLGA</p>	<p>Quebec Lumber Manufacturers' Association (Conseil de l'industrie forestière du Québec) 1175, avenue Lavigerie Bureau 200 Sainte Foy, Québec G1V 4P1 www.qfic.gc.ca</p>

A-Table 9.3.2.1. Lumber Grading.

To identify board grades the paragraph number of the NLGA rules under which the lumber is graded must be shown in the grade mark. Paragraph 113 is equivalent to WWPA rules and paragraph 114 is equivalent to WCLIB rules. When graded in accordance with WWPA or WCLIB rules, the grade mark will not contain a paragraph number.

A-9.3.2.8.(1) Non-Standard Lumber.

The NLGA "Standard Grading Rules for Canadian Lumber" permit lumber to be dressed to sizes below the standard sizes (38 x 89 mm (2" x 4"), 38 x 140 mm (2" x 6"), 38 x 184 mm (2" x 8"), etc.) provided the grade stamp shows the reduced size. This Sentence permits the use of the span tables for such lumber, provided the size indicated on the stamp is not less than 95% of the corresponding standard size. Allowable spans in the tables must be reduced a full 5% even if the undersize is less than the 5% permitted.

A.9.3.2.9.(3) Protection of Structural Wood Elements from Moisture and Decay.

There are many above-ground, structural wood systems where precipitation is readily trapped or drying is slow, creating conditions conducive to decay. Some examples of elements that can accumulate water when exposed to precipitation if they are not detailed to allow drainage are:

- beams extending beyond roof decks
- junctions between deck members
- connections between balcony guards and walls.

A-9.3.2.9.(4) Protection of Retaining Walls and Cribbing from Decay.

Retaining walls supporting soil are considered to be structural elements of the building if a line drawn from the outer edge of the footing to the bottom of the exposed face of the retaining wall is greater than 45° to the horizontal. Retaining walls supporting soil may be structural elements of the building if the line described above has a lower slope.

Retaining walls that are not critical to the support of building foundations but are greater than 1.2 m in height may pose a danger of sudden collapse to persons adjacent to the wall if the wood is not adequately protected from decay. The height of the retaining wall or cribbing is measured as the vertical difference between the ground levels on each side of the wall.

A-9.4.1.1. Structural Design.

Article 9.4.1.1. establishes the principle that the structural members of Part 9 buildings must

- comply with the prescriptive requirements provided in Part 9,
- be designed in accordance with accepted good practice, or
- be designed in accordance with Part 4 using the loads and limits on deflection and vibration specified in Part 9 or Part 4.

Usually a combination of approaches is used. For example, even if the snow load calculation on a wood roof truss is based on Subsections 9.4.2., the joints must be designed in accordance with Part 4. Wall framing may comply with the prescriptive requirements in Subsections 9.23.3., 9.23.10., 9.23.11. and 9.23.12., while the floor framing may be engineered.

Design according to Part 4 or accepted good engineering practice, such as that described in the “Engineering Guide for Wood Frame Construction” (CWC Guide), published by the Canadian Wood Council, requires engineering expertise. The CWC Guide contains alternative solutions and provides information on the applicability of the Part 9 prescriptive structural requirements to further assist designers and building officials to identify the appropriate design approach. The need for professional involvement in the structural design of a building, whether to Part 4 or Part 9 requirements or accepted good practice, is defined by provincial legislation and is reflected in Section 1.2. of Division C.

A-9.4.1.1.(3) Structural Design for Lateral Wind and Earthquake Loads.

The only explicit treatment of structural loads in Section 9.4. is for gravity loads; wind and earthquake loads are dealt with implicitly in the body of Part 9 and are not used as inputs to any of the span tables. There may therefore be a tendency to assume that wind and earthquake loads do not need to be considered in the design of Part 9 buildings. In most cases this is true: the majority of low rise, wood frame buildings have a great deal of structural redundancy and continuity and have more than enough capacity to resist lateral loads due to wind and earthquake.

For example, in a traditional house configuration, even if there are large openings in the exterior walls for picture windows and sliding doors, the many interior partitions act as shear walls and provide adequate lateral stability. This may not be the case for some newer house designs.

However, this does not apply to all building configurations or details that might be found in Part 9 buildings. For example, a mercantile building might be long and narrow with almost entirely windowed walls on the ends and few structurally attached interior partitions. See Figure A-9.4.1.1.(3)A. In such a case, wind and earthquake loads would have to be considered in the design of the long structural walls and their foundations.

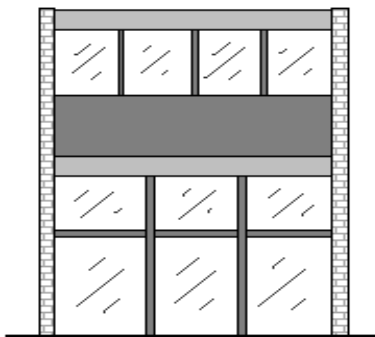


Figure A-9.4.1.1.(3)A
Mercantile Building with Little Resistance to Lateral Loading

Many buildings have been constructed with the lowest level exterior walls as short, wood-frame knee- or pony-walls. In the past, these were often constructed with no lateral bracing and with no interior partitions. The only structural continuity in the foundation-to-knee-wall and knee-wall-to-floor joints comes from nailing and this is inadequate to resist lateral loads from significant earthquakes. See Figure A-9.4.1.1.(3)B. These walls must be braced or sheathed to resist lateral loads from earthquakes. In higher load regions, they should be sheathed. In all regions, storeys with knee-walls should be considered as storeys for the purpose of determining building height and the application of the Part 9 structural requirements.

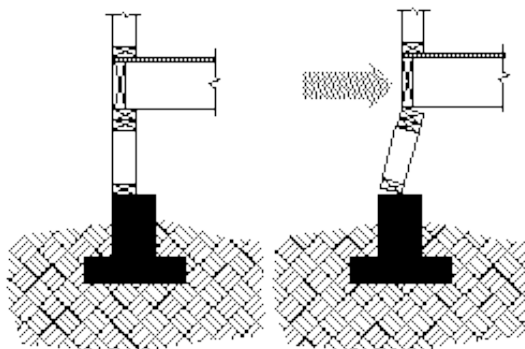


Figure A-9.4.1.1.(3)B
Crawl Space Knee-wall with Little Resistance to Lateral Loading

Thus, Part 9 buildings are not exempt from having to comply with the wind and earthquake loading requirements of Part 4. In many cases, these considerations can safely be ignored but, in certain configurations, the building's resistance to wind and earthquake loads must be carefully considered. See also A-9.23.10.2.

In cases where lateral load design is required, the "Engineering Guide for Wood Frame Construction" (CWC Guide) provides acceptable engineering solutions as an alternative to Part 4. The CWC Guide also contains alternative solutions and provides information on the applicability of the Part 9 prescriptive structural requirements to further assist designers and building officials to identify the appropriate design approach.

A-9.4.2.1.(1) Application of Simplified Part 9 Snow Loads.

The simplified specified snow loads described in Article 9.4.2.2. may be used where the structure is of the configuration that is typical of traditional wood-frame residential construction and its performance. This places limits on the spacing of joists, rafters and trusses, the spans of these members and supporting members, deflection under load, overall dimensions of the roof and the configuration of the roof. It assumes considerable redundancy in the structure.

Because very large buildings may be constructed under Part 9 by constructing firewalls to break up the building area, it is possible to have Part 9 buildings with very large roofs. The simplified specified snow loads may not be used when the total

roof area of the overall structure exceeds 4 550 m². Thus, the simplified specified snow load calculation may be used for typical townhouse construction but would not be appropriate for much larger commercial or industrial buildings, for example.

The simplified specified snow loads are also not designed to take into account roof configurations that seriously exacerbate snow accumulation. This does not pertain to typical projections above a sloped roof, such as dormers, nor does it pertain to buildings with higher and lower roofs. Although two-level roofs generally lead to drift loading, smaller light-frame buildings constructed according to Part 9 have not failed under these loads. Consequently, the simplified calculation may be used in these cases. Rather, this limitation on application of the simplified calculation pertains to roofs with high parapets or significant other projections above the roof, such as elevator penthouses, mechanical rooms or larger equipment that would effectively collect snow and preclude its blowing off the roof.

The reference to Article 9.4.3.1. invokes, for roof assemblies other than common lumber trusses, the same performance criteria for deflection.

The unit weight of snow on roofs, γ , obtained from measurements at a number of weather stations across Canada varied from about 1.0 to 4.5 kN/m³. An average value for use in design in lieu of better local data is $\gamma = 3.0$ kN/m³. In some locations the unit weight of snow may be considerably greater than 3.0 kN/m³. Such locations include regions where the maximum snow load on the roof is reached only after contributions from many snowstorms, coastal regions, and regions where winter rains are considerable and where a unit weight as high as 4.0 kN/m³ may be appropriate.

a5 A-9.4.2.3.(1) Accessible Platforms Subject to Snow and Occupancy Loads.

Many platforms are subject to both occupancy loads and snow loads. These include balconies, decks, verandas, flat roofs over garages and carports. Where such a platform, or a segregated area of such a platform, serves a house or an individual dwelling unit, it must be designed for the greater of either the specified snow load or an occupancy load of 1.9 kPa. Where the platform serves more than one house or an individual dwelling unit or an occupancy other than a residential occupancy, higher occupancy loads will apply, as specified in Table 4.1.5.3.

A-9.4.2.4.(1) Specified Loads for Attics or Roof Spaces with Limited Accessibility.

Typical residential roofs are framed with roof trusses and the ceiling is insulated.

Residential trusses are placed at 600 mm on centre with web members joining top and bottom chords. Lateral web bracing is installed perpendicular to the span of the trusses. As a result, there is limited room for movement inside the attic or roof space or for storage of material. Access hatches are generally built to the minimum acceptable dimensions, further limiting the size of material that can be moved into the attic or roof space.

With exposed insulation in the attic or roof space, access is not recommended unless protective clothing and breathing apparatus are worn.

Thus, the attic or roof space is recognized as uninhabitable and loading can be based on actual dead load. In emergency situations or for the purpose of inspection, it is possible for a person to access the attic or roof space without over-stressing the truss or causing damaging deflections.

A-Table 9.4.4.1. Classification of Soils.

Sand or gravel may be classified by means of a picket test in which a 38 mm by 38 mm (2" x 2") picket bevelled at the end at 45° to a point is pushed into the soil. Such material is classified as “dense or compact” if a man of average weight cannot push the picket more than 200 mm into the soil and “loose” if the picket penetrates 200 mm or more.

Clay and silt may be classified as “stiff” if it is difficult to indent by thumb pressure, “firm” if it can be indented by moderate thumb pressure, “soft” if it can be easily penetrated by thumb pressure, where this test is carried out on undisturbed soil in the wall of a test pit.

A-9.4.4.4.(1) Soil Movement.

In susceptible soils, changes in temperature or moisture content can cause significant expansion and contraction. Soils containing pyrites can expand simply on exposure to air.

Expansion and Contraction due to Moisture

Clay soils are most prone to expansion and contraction due to moisture. Particularly wet seasons can sufficiently increase the volume of the soil under and around the structure to cause heaving of foundations and floors-on-ground, or cracking of foundation walls. Particularly dry seasons or draw-down of water by fast-growing trees can decrease the volume of the soil supporting foundations and floors-on-ground, thus causing settling.

Frost Heave

Frost heave is probably the most commonly recognized phenomenon related to freezing soil. Frost heave results when moisture in frost-susceptible soil (clay and silt) under the footings freezes and expands. This mechanism is addressed by requirements in Section 9.12. regarding the depth of excavations.

Ice Lenses

When moisture in frost-susceptible soils freezes, it forms an ice lens and reduces the vapour pressure in the soil in the area immediately around the lens. Moisture in the ground redistributes to rebalance the vapour pressures providing more moisture in the area of the ice lens. This moisture freezes to the lens and the cycle repeats itself. As the ice lens grows, it exerts pressure in the direction of heat flow. When lenses form close to foundations and heat flow is toward the foundation - as may be the case with unheated crawl spaces or open concrete block foundations insulated on the interior - the forces may be sufficient to crack the foundation.

Adfreezing

Ice lenses can adhere themselves to cold foundations. Where heat flow is essentially upward, parallel to the foundation, the pressures exerted will tend to lift the foundation. This may cause differential movement or cracking of the foundation. Heat loss through basement foundations of cast-in-place concrete or concrete block insulated on the exterior appears to be sufficient to prevent adfreezing. Care must be taken where the foundation does not enclose heated space or where open block foundations are insulated on the interior. The installation of semi-rigid glass fibre insulation has demonstrated some effectiveness as a separation layer to absorb the adfreezing forces.

Pyrites

Pyrite is the most common iron disulphide mineral in rock and has been identified in rock of all types and ages. It is most commonly found in metamorphic and sedimentary rock, and especially in coal and shale deposits.

Weathering of pyritic shale is a chemical-microbiological oxidation process that results in volume increases that can heave foundations and floors-on-ground. Concentrations of as little as 0.1% by weight have caused heaving. Weathering can be initiated simply by exposing the pyritic material to air. Thus, building on soils that contain pyrites in concentrations that will cause damage to the building should be avoided, or measures should be taken to remove the material or seal it.

Material containing pyrites should not be used for backfill at foundations or for supporting foundations or floors-on-ground.

Where it is not known if the soil or backfill contains pyritic material in a deleterious concentration, a test is available to identify its presence and concentration.

References:

- (1) Legget, R.F. and Crawford, C.B. *Trees and Buildings*. Canadian Building Digest 62, Division of Building Research, National Research Council Canada, Ottawa, 1965.
- (2) Hamilton, J.J. *Swelling and Shrinking Subsoils*. Canadian Building Digest 84, Division of Building Research, National Research Council Canada, Ottawa, 1966.
- (3) Hamilton, J.J. *Foundations on Swelling and Shrinking Subsoils*. Canadian Building Digest 184, Division of Building Research, National Research Council Canada, Ottawa, 1977.
- (4) Penner, W., Eden, W.J., and Gratten-Bellew, P.E. *Expansion of Pyritic Shales*. Canadian Building Digest 152, Division of Building Research, National Research Council Canada, Ottawa, 1975.

- (5) Swinton, M.C., Brown, W.C., and Chown, G.A. Controlling the Transfer of Heat, Air and Moisture through the Building Envelope. Small Buildings - Technology in Transition, Building Science Insight '90, Institute for Research in Construction, National Research Council Canada, Ottawa, 1990.

A-9.4.4.6. and A-9.15.1.1. Loads on Foundations.

The prescriptive solutions provided in Part 9 relating to footings and foundation walls only account for the loads imposed by drained earth. Drained earth is assumed to exert a load equivalent to the load that would be exerted by a fluid with a density of 480 kg/m³. The prescriptive solutions do not account for surcharges from saturated soil or additional loads from heavy objects located adjacent to the building. Where such surcharges are expected, the footings and foundation walls must be designed and constructed according to Part 4.

A-9.5.1.4. Combination Rooms.

If a room draws natural light and natural ventilation from another area, the opening between the two areas must be large enough to effectively provide sufficient light and air. This is why a minimum opening of 3 m² is required, or the equivalent of the area of a set of double doors. The effectiveness of the transfer of light and air also depends on the size of the transfer opening in relation to the size of the dependent room; in measuring the area of the wall separating the two areas, the whole wall on the side of the dependent room should be considered, not taking into account offsets that may be in the surface of the wall.

The opening does not necessarily have to be in the form of a doorway; it may be an opening at eye level. However, if the dependent area is a bedroom, provision must be made for the escape window required by Article 9.7.1.3. to fulfill its safety function. This is why a direct passage is required between the bedroom and the other area; the equivalent of at least a doorway is therefore required for direct passage between the two areas.

e2.1 A-9.5.2.3.(1) Stud Wall Reinforcement.

This provision for future attachment of grab bars in the main bathroom of a residential occupancy including houses requires the installation of suitable blocking in the stud wall. Sentence 9.31.2.3.(1) specifies the required load resistance. Also, see Appendix Note A-3.3.4.9.(1).

e7 A-9.6.1.2.(2) Mirrored Glass Doors.

Standard CAN/CGSB-82.6-M, "Doors, Mirrored Glass, Sliding or Folding, Wardrobe", covers mirrored glass doors for use on reach-in closets. It specifies that such doors are not to be used for walk-in closets.

a10.1 A-9.6.1.3.(2) Maximum Glass Area.

Tables 9.6.1.3.A. to 9.6.1.3.F. are based on CAN/CGSB-12.20-M, "Structural Design of Glass for Buildings", and the wind load provisions in Article 4.1.7.3. The maximum glass area values given in these Tables are intended to be equal to or smaller than those that would be determined using the standard and wind load provisions directly to design for each individual case.

a10.1 A-Table 9.6.1.3.G. Glass in Doors.

Maximum areas in Table 9.6.1.3.G. for other than fully tempered glazing are cut off at 1.50 m², as this would be the practical limit after which safety glass would be required by Sentence 9.6.1.4.(2).

A-9.7.3.2.(1)(a) Minimizing Condensation.

The total prevention of condensation on the surfaces of fenestration products is difficult to achieve and, depending on the design and construction of the window or door, may not be absolutely necessary. Clause 9.7.3.2.(1)(a) therefore requires that condensation be minimized, which means that the amount of moisture that condenses on the inside surface of a window, door or skylight, and the frequency at which this occurs, must be limited. The occurrence of such condensation must be sufficiently rare, the accumulation of any water must be sufficiently small, and drying must be sufficiently rapid to prevent the deterioration of moisture-susceptible materials and the growth of fungi.

A-9.7.4.2.(1) Standards Referenced for Windows, Doors and Skylights.

Canadian Requirements in the Harmonized Standard

In addition to referencing the Canadian Supplement, CSA A440S1, “Canadian Supplement to AAMA/WDMA/CSA 101/I.S.2/A440, “NAFS - North American Fenestration Standard/Specification for Windows, Doors, and Skylights,” the Harmonized Standard, AAMA/WDMA/CSA 101/I.S.2/A440, “NAFS - North American Fenestration Standard/Specification for Windows, Doors, and Skylights,” contains some Canada-specific test criteria.

Standards Referenced for Excluded Products

Clause 1.1, General, of the Harmonized Standard defines the limits to the application of the standard with respect to various types of fenestration products. A list of exceptions to the application statement identifies a number of standards that apply to excluded products. Compliance with those standards is not required by the Code; the references are provided for information purposes only.

Label Indicating Performance and Compliance with Standard

The Canadian Supplement requires that a product’s performance ratings be indicated on a label according to the designation requirements in the Harmonized Standard and that the label include

- design pressure, where applicable,
- negative design pressure, where applicable,
- water penetration test pressure, and
- the Canadian air infiltration and exfiltration levels.

It should be noted that, for a product to carry a label in Canada, it must meet all of the applicable requirements of both the Harmonized Standard and the Canadian Supplement, including the forced entry requirements.

Water Penetration Resistance

For the various performance grades listed in the Harmonized Standard, the corresponding water penetration resistance test pressures are a percentage of the design pressure. For R-class products, water penetration resistance test pressures are 15% of design pressure. In Ontario, driving rain wind pressures (DRWP) have been determined for the locations listed in MMAH Supplementary Standard SB-1.

To achieve equivalent levels of water penetration resistance for all locations, the Canadian Supplement includes a provision for calculating specified DRWP at the building site considering building exposure. Specified DRWP values are, in some cases, greater than 15% of design pressure and, in other cases, less than 15% of design pressure. For a fenestration product to comply with the Code, it must be able to resist the structural and water penetration loads at the building site. Reliance on a percentage of design pressure for water penetration resistance in the selection of an acceptable fenestration product will not always be adequate. Design pressure values are reported on a secondary designator, which is required by the Canadian Supplement to be affixed to the window. The DRWP given in the Canadian Supplement should be used for all products covered in the scope of the Harmonized Standard.

Uniform Load Structural Test

The Harmonized Standard specifies that fenestration products be tested at 150% of design pressure for wind (specified wind load) and that skylights and roof windows be tested at 200% of design pressure for snow (specified snow load). With the change in the 2006 Building Code to a 1-in-50 return period for wind load, a factor of 1.4 rather than 1.5 is now applied for wind. The Building Code has traditionally applied a factor of 1.5 rather than 2.0 for snow. Incorporating these lower load factors into the Code requirements for fenestration would better reflect acceptable minimum performance levels; however, this has not been done in order to avoid adding complexity to the Code, to recognize the benefits of Canada-US harmonization, and to recognize that differentiation of products that meet the Canadian versus the US requirements would add complexity for manufacturers, designers, specifiers and regulatory officials.

Condensation Resistance

The Harmonized Standard identifies three test procedures that can be used to determine the condensation resistance of windows and doors. Only the physical test procedure given in CSA A440.2, which is referenced in Table 9.7.3.3., can be used to establish Temperature Index (I) values. Computer simulation tools can also be used to estimate the relative condensation resistance of windows, but these methods employ different expressions of performance known as Condensation Resistance Factors (CR). I and CR values are not interchangeable.

Where removable multiple glazing panels (RMGP) are installed on the inside of a window, care should be taken to hermetically seal the RMGP against the leakage of moisture-laden air from the interior into the cavity on the exterior of the RMGP because the moisture transported by the air could lead to significant condensation on the interior surface of the outside glazing.

Basement Windows

- a10.1** Clause 12.4.2, Basement Windows, of the Harmonized Standard refers to products that are intended to meet Code requirements for ventilation and emergency egress. The minimum test size of 800 mm x 360 mm (total area of 0.288 m²) specified in the standard will not provide the minimum openable area required by the Code for bedrooms (i.e. 0.35 m² with no dimension less than 380 mm) and the means to provide minimum open area identified in the standard is inconsistent with the requirements of the Code (see Subsection 9.9.10. for bedroom windows). The minimum test size specified in the standard will also not provide the minimum ventilation area of 0.28 m² required for non-heating-season natural ventilation (see Article 9.32.2.2.).

Greenhouse Windows

Greenhouse-type windows feature a sloped, roof-like top portion, which is subjected to the same snow loads as roofs. The Canadian Supplement only applies the snow load calculation to skylights, which do not include greenhouse windows according to the definition for skylights given in the Canadian Supplement and the Harmonized Standard. Where such windows are used, it is recommended that snow loads on the top portion of the window be taken into account.

a10.1 Performance of Doors: Limited Water Ingress Control.

While the control of precipitation ingress is a performance requirement for exterior doors, side-hinged doors can comply with the referenced standard. AAMA/WDMA/CSA 101/I.S.2/A440, “NAFS – North American Fenestration Standard/Specification for Windows, Doors, and Skylights”, when tested at a pressure differential of 0 Pa (0.0 psf) or higher, but less than the minimum test pressure required for the indicated performance class and performance grade. Such doors are identified with a “Limited Water” (LW) rating on the product label.

There is no restriction on the use of side-hinged doors having a limited water designation when the tested water penetration resistance of such doors is equal to or greater than the specified Driving Rain Wind Pressure for the building location, as stated in Clause A.4.4 of CSA A440S1, “Canadian Supplement to AAMA/WDMA/CSA 101/I.S.2/A440, NAFS – North American Fenestration Standard/Specification for Windows, Doors, and Skylights”. When an LW door does not have sufficient water penetration resistance for the building location, Clause B.5.3.3 of CSA A440S1 states that these doors should only be used and installed in a protected location, such as under a porch roof. Other protected locations would be behind a storm door, or a door separating conditioned space from unconditioned space, such as in cold storage rooms. The Exposure Nomograph in Annex A of CAN/CSA-A440.4, “Window, Door, and Skylight Installation”, provides an acceptable method to determine whether a door is considered protected, which depends on overhang ratio, and the terrain and moisture index of the building location. A door with an LW rating and a low exposure could provide acceptable water penetration resistance. However, given that the Exposure Nomograph in Annex A of CAN/CSA-A440.4 does not account for the intensity of wind driven rain, a door with an LW rating may not provide appropriate protection in some locations. In such cases, the risk of water penetration may remain the same as if the overhead protection were not provided.

A-9.7.5.2.(1) Forced Entry Via Glazing in Doors and Sidelights.

There is no mandatory requirement that special glass be used in doors or sidelights, primarily because of cost. It is, however, a common method of forced entry to break glass in doors and sidelights to gain access to door hardware and unlock the door from the inside. Although insulated glass provides increased resistance over single glazing, the highest resistance is provided by laminated glass. Tempered glass, while stronger against static loads, is prone to shattering under high, concentrated impact loads.

Laminated glass is more expensive than annealed glass and must be used in greater thicknesses. Figure A-9.7.5.2.(1) shows an insulated sidelight made of one pane of laminated glass and one pane of annealed glass. This method reduces the cost premium that would result if both panes were laminated.

Consideration should be given to using laminated glazing in doors and accompanying sidelights regulated by Article 9.6.1.3., in windows located within 900 mm of locks in such doors, and in basement windows.

Underwriters' Laboratories of Canada have produced ULC-S332, "Burglary Resisting Glazing Material", which provides a test procedure to evaluate the resistance of glazing to attacks by thieves. While it is principally intended for plate glass show windows, it may be of value for residential purposes.

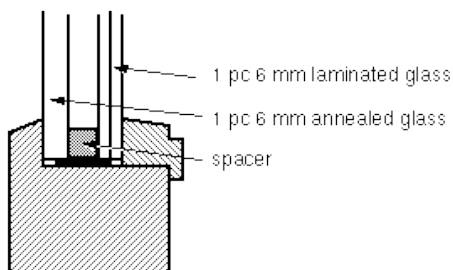


Figure A-9.7.5.2.(1)
Combined Laminated / Annealed Glazing

A-9.7.5.2.(2) Resistance of Doors to Forced Entry.

This Sentence designates standard ASTM F476, “Test Methods for Security of Swinging Door Assemblies” as an alternate to compliance with the prescriptive requirements for doors and hardware. The annex to the standard provides four security classifications, with acceptance criteria, depending on the type of building and the crime rate of the area in which it is located. The Building Code has only specified Grade 10, the minimum level. The annex suggests the following guidelines be followed when selecting security levels for door assemblies:

- Grade 10: This is the minimum security level and is quite adequate for single-family residential buildings located in stable, low-crime areas.
- Grade 20: This is the low-medium security level and is designed to provide security for residential buildings located in average crime-rate areas and for apartments in both low and average crime-rate areas.
- Grade 30: This is the medium-high security level and is designed to provide security for residential buildings located in higher than average crime-rate areas or for small commercial buildings in average or low crime-rate areas.
- Grade 40: This is the high security level and is designed for small commercial buildings located in high crime-rate areas. This level could also be used for residential buildings having an exceptionally high incidence of semi-skilled burglary attacks.

All these grades satisfy the Code and can be considered for use where a higher level of security is desired or warranted.

9.7.5.2.(6) Door Fasteners.

The purpose of the requirement for 30 mm screw penetration into solid wood is to prevent the door from being dislodged from the jamb due to impact forces. It is not the intent to prohibit other types of hinges or strikeplates that are specially designed to provide equal or greater protection.

A-9.7.5.2.(8) Hinged Doors.

Methods of satisfying this Sentence include either using non-removable pin hinges or modifying standard hinges by screw fastening a metal pin in a screw hole in one half of the top and bottom hinges. When the door is closed, the projecting portion of the pin engages in the corresponding screw hole in the other half of the hinge and then, even if the hinge pin is taken out, the door cannot be removed.

A-9.7.5.3.(1) Resistance of Windows to Forced Entry.

Although this Sentence only applies to windows within 2 m of adjacent ground level, certain house and site features, such as balconies or canopy roofs, allow for easy access to windows at higher elevations. Consideration should be given to specifying break-in resistant windows in such locations.

This Sentence does not apply to windows that do not serve the interior of the dwelling unit, such as windows to garages, sun rooms or greenhouses, provided connections between these spaces and the dwelling unit are secure.

One method that is often used to improve the resistance of windows to forced entry is the installation of metal “security bars”. However, while many such installations are effective in increasing resistance to forced entry, they may also reduce or eliminate the usefulness of the window as an exit in case of fire or other emergency that prevents use of the normal building exits. Indeed, unless such devices are easily openable from the inside, their installation in some cases would contravene the requirements of Article 9.9.10.1., which requires every bedroom that does not have an exterior door to have at least one window that is large enough and easy enough to open that it can be used as an exit in case of emergency. Thus an acceptable security bar system should be easy to open from the inside while still providing increased resistance to entry from the outside.

a10.2 A-9.8.3.1. Permitted Stair Configurations.

**Table A-9.8.3.1.
Permitted Stair Configurations**

Location/Use of Stairs	Configuration of Stair Treads				
	Straight Flight with Rectangular Treads	Curved Flight with Tapered Treads	Winders	Flight with a mix of Rectangular Treads and Tapered Treads	Spiral Stairs
Stairs within dwelling units	Permitted ⁽¹⁾	Permitted ⁽²⁾	Permitted ⁽³⁾	Permitted ⁽⁴⁾	Permitted ⁽⁵⁾
Public stairs	Permitted ⁽¹⁾	Permitted ⁽⁶⁾	Not permitted	Not permitted	Permitted ⁽⁵⁾
Exit stairs	Permitted ⁽¹⁾	Permitted ⁽⁶⁾	Not permitted	Not permitted	Not permitted

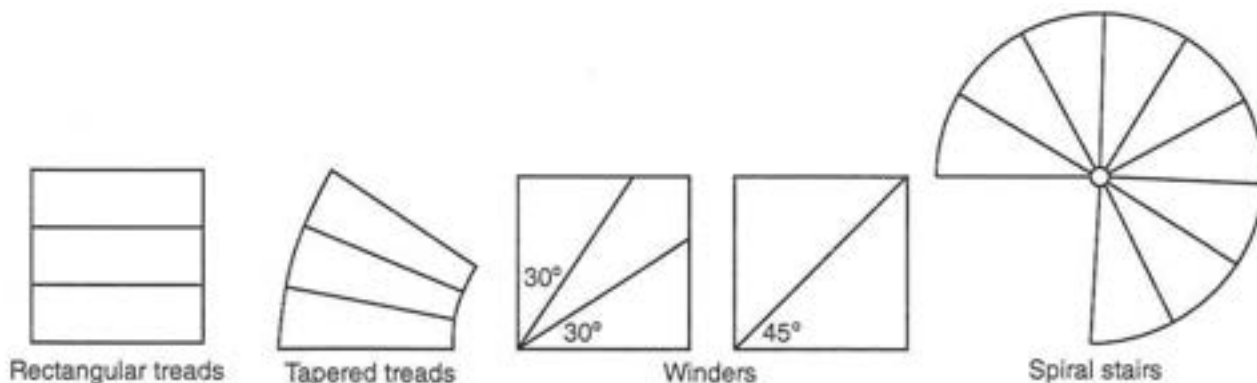
Notes to Table A-9.8.3.1.:

1. See Articles 9.8.4.1. and 9.8.4.2.
2. See Article 9.8.4.1. and 9.8.4.3.
3. See Article 9.8.4.5.
4. See Article 9.8.4.4A.
5. See Sentence 9.8.4.5A.
6. See Articles 3.4.6.9. and 9.8.4.3.

a10.2 A-9.8.4. Step Dimensions.

The Code distinguishes four principal types of stair treads:

- rectangular treads, which are found in straight flights;
- tapered treads are found in curved flights;
- winders are described in Appendix Note A-9.8.4.5.; and
- spiral stairs are described in Appendix Note A-9.8.4.5A. See Figure A-9.8.4.A.



**Figure A-9.8.4.A.
Types of Treads**

Articles 9.8.4.1. to 9.8.4.6. specify various dimensional limits for steps. Figure A-9.8.4.B illustrates the elements of a step and how these are to be measured.

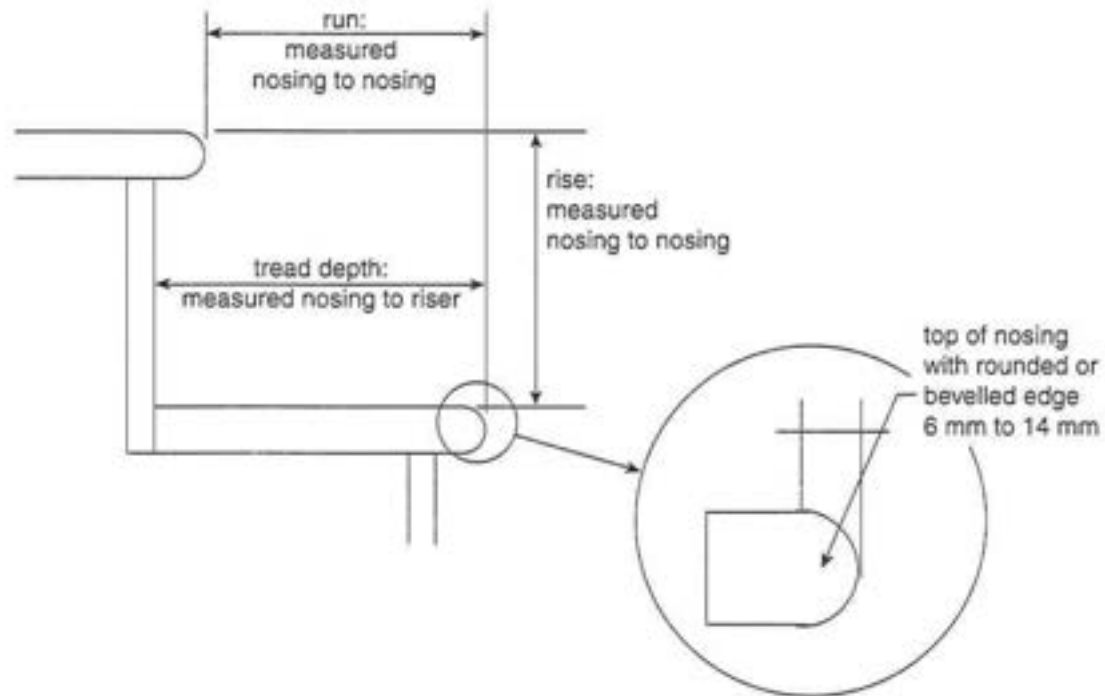


Figure A-9.8.4.B.
Elements of Steps and their Measurement

A-9.8.4.5. Winders.

The safest method of incorporating a change in the direction of a stair is to use a landing. Within a dwelling unit, however, where occupants are familiar with their environment, winders are an acceptable method of reducing the amount of floor area devoted to the stair and have not been shown to be more hazardous than a straight run of steps. Nevertheless, care is required to ensure that winders are as safe as possible. Experience has shown that 30° winders are the best compromise and require the least change in the natural gait of the stair user; 45° winders are also acceptable, as they are wider. The Code permits winders to turn through any angle between 30° and 45°, inclusive. This allows winder-type stairs to change direction through any angle between 30° (1 winder) and 90° (2 or 3 winders).

a10.2 A-9.8.4.5A. Spiral Stairs.

A spiral stair is typically described as a stair with a circular plan having uniform treads that radiate from and wind around a common central post or supporting column.

In the context of the Code, the term “spiral stair” is used to describe any stair where:

- a) the plan of the treads forms part or all of the circle,
- b) the maximum stair width and tread depth are less than those required for curved stairs, and
- c) the maximum riser height is greater than that permitted in all other stair configurations.

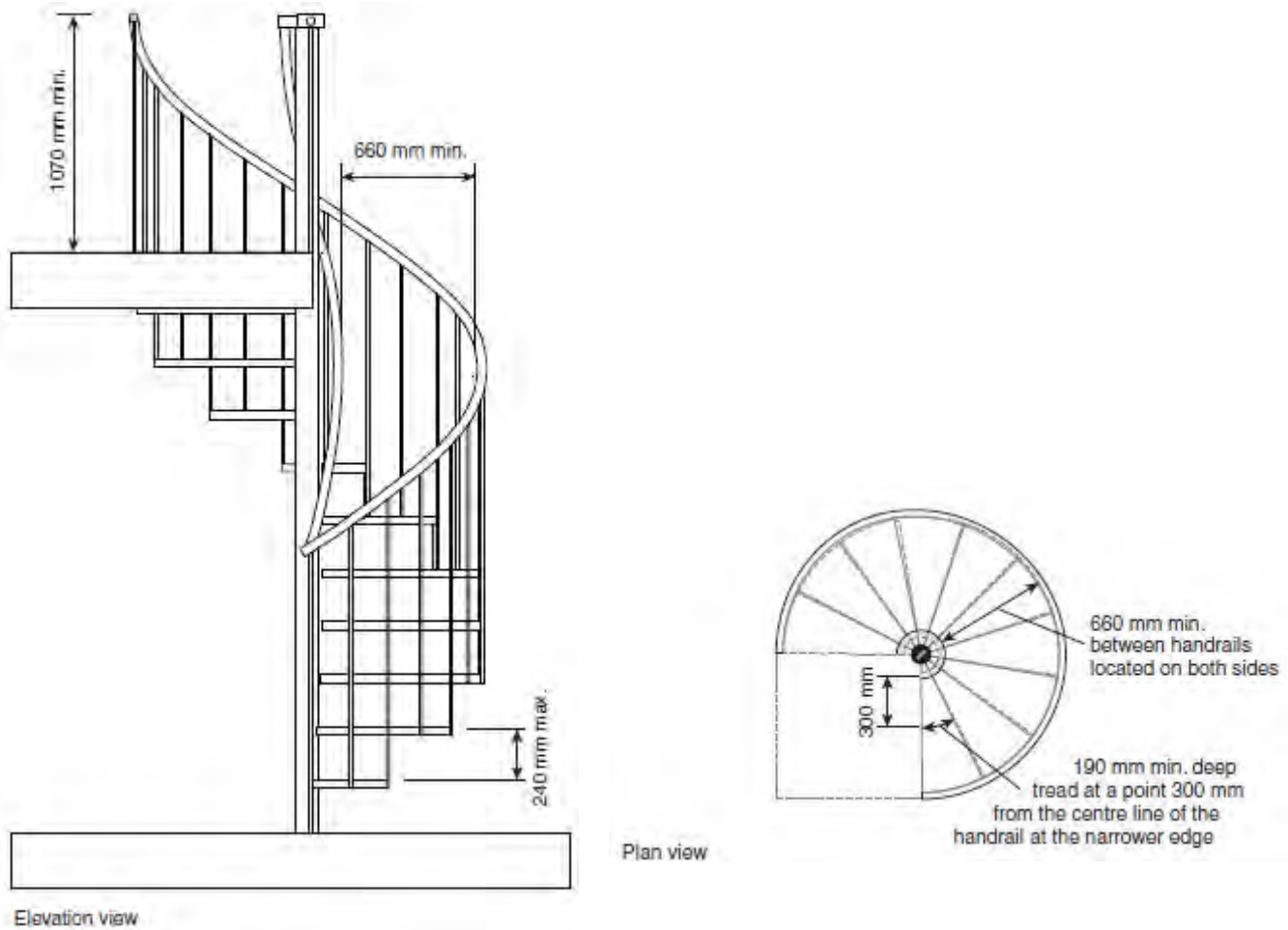


Figure A-9.8.4.5A.
Spiral Stairs

A-9.8.4.6.(1) Tread Projection and Leading Edge of Steps.

A sloped or beveled edge on nosings or leading edges of steps will make the tread more visible through light modelling. The sloped portion of the leading edge must not be too wide so as to reduce the risk of slipping of the foot. To reduce the risk of tripping, the leading edge must not reduce the effective tread depth to less than the required minimum tread depth less 15 mm. Similarly, the projection of the tread behind the nosing can also cause tripping, particularly during a person's ascent. Figure A-9.8.4.6. illustrates the various dimensional requirements stated in Sentence 9.8.4.6.(1).

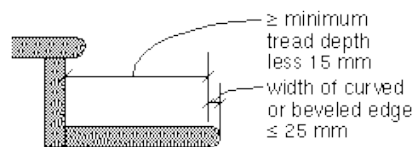


Figure A-9.8.4.6.
Tread Depth and Treatment of Leading Edge

a10.2 A-9.8.7.1.(2) Wider Stairs than Required.

The intent of Sentence 9.8.7.1.(2) is that handrails be installed in relation to the required exit width only, regardless of the actual width of the stair and ramp. The required handrails are provided along the assumed natural path of travel to and from the building.

a10.2 A-9.8.7.2. Continuity of Handrails.

The guidance and support provided by handrails is particularly important at the beginning and end of ramps and flights of stairs and at changes in direction such as at landings and winders.

The intent of the requirement in Sentence (2) for handrails to be continuous throughout the length of the stair is that the handrail be continuous from the bottom riser to the top riser of the stair. (See Figure A-9.8.7.2.)

For stairs or ramps serving a house or an individual dwelling unit, the intent of the requirement for handrails to be continuous throughout the length of the flight is that the handrail be continuous from the bottom riser to the top riser of the flight. The required handrail may start back from the bottom riser only if it is supported by a newel post or volute installed on the bottom tread. (See Figure A-9.8.7.2.) With regard to stairs serving a house or an individual dwelling unit, the handrail may terminate at landings.

In the case of stairs within dwelling units that incorporate winders, the handrail should be configured so that it will in fact provide guidance and support to the stair user throughout the turn through the winder.

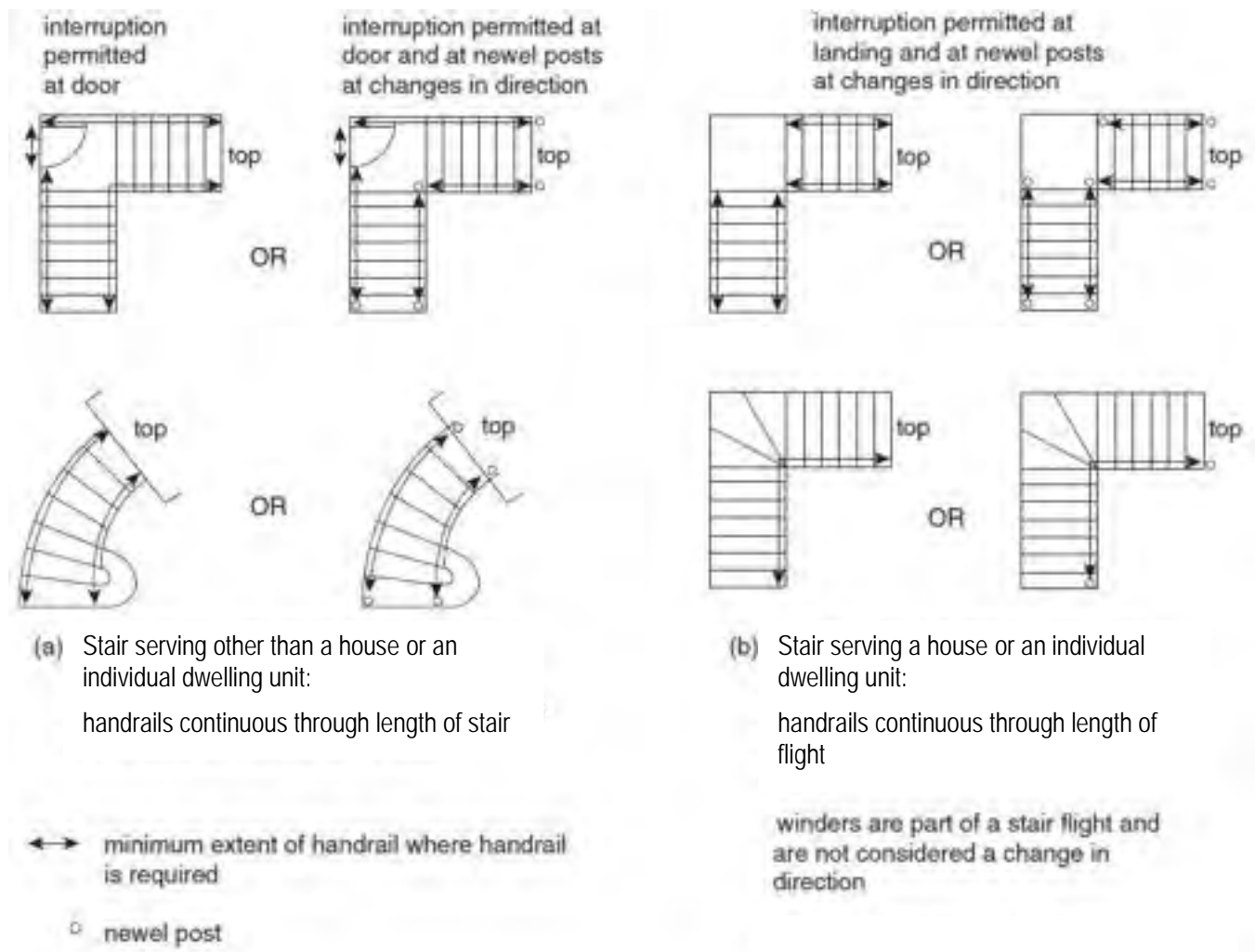


Figure A-9.8.7.2.
Continuity of Handrails at the Top and Bottom of Stairs and Flights of Stairs

Notes to Figure A-9.8.7.2.:

(1) See Article 9.8.7.1. to determine the number of handrails required. Some stairs will require only one, while some will require two or more.

A-9.8.7.3.(1) Termination of Handrails.

Handrails are required to be installed so as not to obstruct pedestrian travel. To achieve this end, the rail should not extend so far into a hallway as to reduce the clear width of the hallway to less than the required width. Where the stair terminates in a room or other space, likely paths of travel through that room or space should be assessed to ensure that any projection of the handrail beyond the end of the stair will not interfere with pedestrian travel. As extensions of handrails beyond the first and last riser are not required in dwelling units [See Sentence 9.8.7.3.(2)] and as occupants of dwellings are generally familiar with their surroundings, the design of dwellings would not generally be affected by this requirement.

Handrails are also required to terminate in a manner that will not create a safety hazard to blind or visually impaired persons, children whose heads may be at the same height as the end of the rail, or persons wearing loose clothing or carrying items that might catch on the end of the rail. One approach to reducing potential hazards is returning the handrail to a wall, floor or post. Again, within dwelling units, where occupants are generally familiar with their surroundings, returning the handrail to a wall, floor or post may not be necessary. For example, where the handrail is fastened to a wall and does not project past the wall into a hallway or other space, a reasonable degree of safety is assumed to be provided; other alternatives may provide an equivalent level of protection.

A-9.8.7.3.(2) Handrail Extensions.

As noted in Appendix Note A-9.8.7.2., the guidance and support provided by handrails is particularly important at the beginning and end of ramps and flights of stairs and at changes in direction. The extended handrail provides guidance and allows users to steady themselves upon entering or leaving a ramp or flight of stairs. Such extensions are particularly useful to visually-impaired persons, and persons with physical disabilities or who are encumbered in their use of the stairs or ramp.

A-9.8.7.4. Height of Handrails.

Figure A-9.8.7.4. illustrates how to measure handrail height.

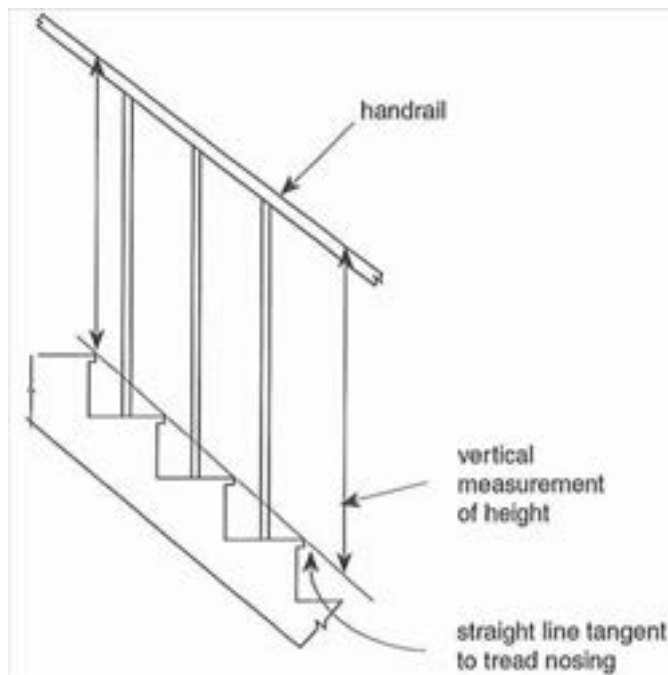


Figure A-9.8.7.4.
Measuring Handrail Height

a10.2 A-9.8.7.5.(2) Handrail Sections.

Handrails are intended to provide guidance and support to stair users. To fulfil this intent, handrails must be “graspable”.

The graspable portion of a handrail should allow a person to comfortably and firmly grab hold by allowing their fingers and thumb to curl under part or all of the handrail. Where the configuration or dimensions of the handrail do not allow a person’s fingers and thumb to reach the bottom of it, recesses that are sufficiently wide and deep to accommodate a person’s fingers and thumb must be provided on both sides of the handrail, at the bottom of the graspable portion, which must not have sharp edges.

a5 A-9.8.7.7. Attachment of Handrails.

Handrails are intended to provide guidance and support to the stair user and to arrest falls. The loads on handrails may therefore be considerable. The attachment of handrails serving a house or an individual dwelling unit may be accepted on the basis of experience, structural design, or the prescriptive requirements of Sentence 9.8.7.7.(2).

A-9.8.8.1. Required Guards.

The requirements relating to guards stated in Part 9 are based on the premise that, wherever there is a difference in elevation of 600 mm or more between two floors, or between a floor or other surface to which access is provided for other than maintenance purposes and the next lower surface, the risk of injury in a fall from the higher surface is sufficient to warrant the installation of some kind of barrier to reduce the chances of such a fall. A wall along the edge of the higher surface will obviously prevent such a fall, provided the wall is sufficiently strong that a person cannot fall through it. Where there is no wall, a guard must be installed. Because guards clearly provide less protection than walls, additional requirements apply to guards to ensure that a minimum level of protection is provided. These relate to the characteristics described in Appendix Notes A-9.8.8.3., A-9.8.8.5.(1) and (2), A-9.8.8.5.(3) and A-9.8.8.6.(1).

Examples of such surfaces where the difference in elevation could exceed 600 mm and consequently where guards would be required include, but are not limited to, landings, porches, balconies, mezzanines, galleries, and raised walkways. Especially in exterior settings, surfaces adjacent to walking surfaces, stairs or ramps often are not parallel to the walking surface or the surface of the treads or ramps. Consequently, the walking surface, stair or ramp may need protection in some locations but not in others. (See Figure A-9.8.8.1.) In some instances, grades are artificially raised close to walking surfaces, stairs or ramps to avoid installing guards. This provides little or no protection for the users. That is why the requirements specify differences in elevation not only immediately adjacent to the construction but also for a distance of 1 200 mm from it by requiring that the slope of the ground be within certain limits. (See Figure A-9.8.8.1.)

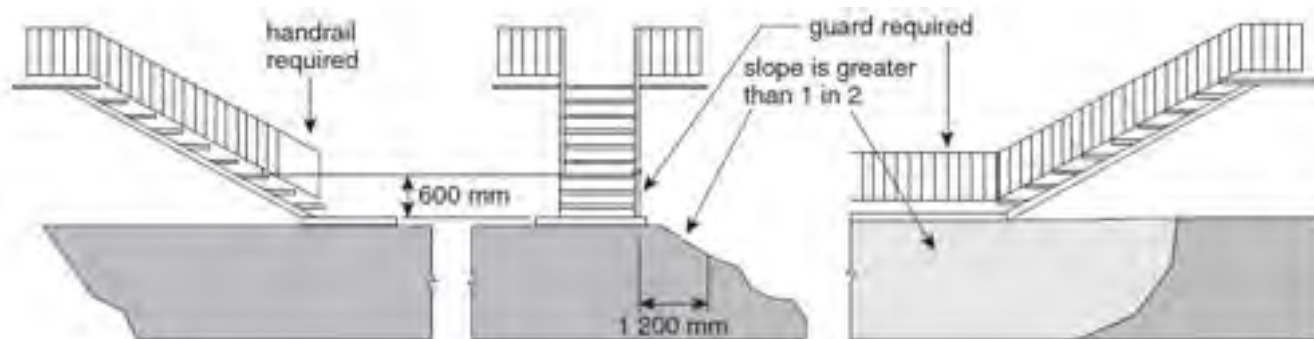

a10.2

Figure A-9.8.8.1.
Required Locations of Guards

A-9.8.8.1.(5) Height of Window Sills Above Floors or Ground.

The primary intent of the requirement is to minimize the likelihood of small children falling significant heights from open windows. Reflecting reported cases, the requirement applies only to dwelling units and generally those located on the second floor or higher of residential or mixed use buildings where the windows are essentially free-swinging or free-sliding.

Free-swinging or free-sliding means that a window that has been cracked open can be opened further by simply pushing on the openable part of the window. Care must be taken in selecting windows, as some with special operating hardware can still be opened further by simply pushing on the window.

- e7.1 Casement windows with crank operators could, in some cases, be considered to conform to Clause (5)(b). To provide additional safety, where slightly older children are involved, occupants can easily remove the crank handles from these windows. Awning windows with scissor hardware, however, may not keep the window from swinging open once it is unlatched. Hopper windows would be affected only if an opening is created at the bottom as well as at the top of the window. The requirement will impact primarily on the use of sliding windows which do not incorporate devices in their construction that can be used to limit the openable area of the window.
- a3 The 100 mm opening limit is consistent with widths of openings that small children cannot fall through. Again, care must be taken in selecting a window. At some position, scissor hardware on an awning window may break up the open area such that there is no unobstructed opening with dimensions greater than 100 mm. At another position, however, though the window is not open much more, the hardware may not adequately break up the opening. The 480 mm height off the floor recognizes that furniture is often placed under windows and small children are often good climbers.

A-9.8.8.2. Loads on Guards.

Guards must be constructed so as to be strong enough to protect persons from falling under normal use. Many guards installed in dwelling units or on exterior stairs serving one or two dwelling units have demonstrated acceptable performance over time. The loading specified in the first row of Table 9.8.8.2. is intended to be consistent with the performance provided by these guards. Guards constructed in accordance with MMAH Supplementary Standard SB-7 are deemed to meet the requirements of Article 9.8.8.2.

The load on guards within dwelling units, or on exterior guards serving not more than two dwelling units, is to be imposed over an area of the guard such that, where standard balusters are used and installed at the maximum 100 mm spacing permitted for required guards, 3 balusters will be engaged. Where the balusters are wider, only two may be engaged unless they are spaced closer together. Where the guard is not required, and balusters are installed more than 100 mm apart, fewer balusters may be required to carry the imposed load.

A-9.8.8.3. Minimum Heights.

Guard heights are generally based on the waist heights of average persons. Generally, lower heights are permitted in dwelling units because the occupants become familiar with the potential hazards, and situations which lead to pushing and jostling under crowded conditions are less likely to arise.

e6 A-9.8.8.5.(1) and (2) Risk of Falling Through Guards.

The risk of falling through a guard is especially prevalent for children. Therefore, the requirements are stringent for guards in all buildings except industrial buildings, where children are unlikely to be present except under strict supervision.

A-9.8.8.5.(3) Risk of Children Getting Their Heads Lodged Between Balusters.

The requirements to prevent children falling through guards also serve to provide adequate protection against this problem. However, guards are often installed where they are not required by the Code; i.e., in places where the difference in elevation is less than 600 mm. In these cases, there is no need to require the openings between balusters to be less than 100 mm. However, there is a range of openings between 100 mm and 200 mm in which children can get their heads stuck. Therefore, openings in this range are not permitted except in buildings of industrial occupancy, where children are unlikely to be present except under strict supervision.

e7.1 A-9.8.8.6.(1) Risk of Children Climbing Over Guards.

Guards are sometimes constructed with horizontal or near-horizontal members between balusters such that a ladder effect is achieved. This can be very tempting for young children to climb, thus exposing themselves to risk of falling over the guard. Such construction is not permitted for required guards in buildings of residential occupancy.

a2.1 A-9.8.9.6. Finish for Treads, Landings and Ramps.

A tactile indicator strip signals a warning to people with no or low vision that they are approaching a change in level. The strip is set back from the leading edge of the stair to provide sufficient warning of the change in level in advance. Also, see Appendix Note A-3.4.6.1.(2).

A-9.9.4.5.(1) Openings in Exterior Walls of Exits.

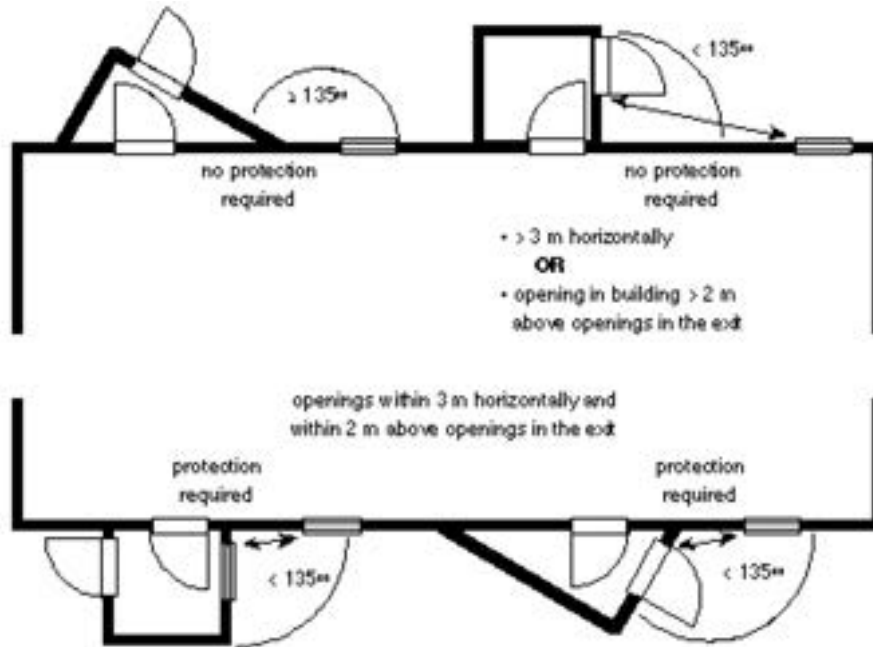


Figure A-9.9.4.5.(1)
Protection of Openings in Exterior Walls of Exits

A-9.9.8.4.(1) Independent and Remote Exits.

- a10.1** Subsection 9.9.8. requires that some floor areas have more than one exit. The intent is to ensure that, if one exit is made untenable or inaccessible by a fire, or its exterior door is blocked by an exterior incident, one or more other exits will be available to permit the occupants to escape. However, if the exits are close together, all exits might be made untenable or inaccessible by the same fire. Sentence 9.9.8.4.(1), therefore, requires at least two of the exits to be located remotely from each other. This is not a problem in many buildings falling under Part 9. For instance, apartment buildings usually have exits located at either end of long corridors. However, in other types of buildings (e.g., dormitory and college residence buildings) this is often difficult to accomplish and problems arise in interpreting the meaning of the word “remote”. Article 3.4.2.3. is more specific, generally requiring the distance between exits to be one half the diagonal dimension of the floor area or at least 9 m. However, it is felt that such criteria would be too restrictive to impose on the design of all the smaller buildings which are governed by Part 9. Nevertheless, the exits should be placed as far apart as possible and the Part 3 criteria should be used as a target. Designs in which the exits are so close together that they will obviously both become contaminated in the event of a fire are not acceptable.

A-9.9.10.1.(1) Bedroom Window Opening Areas and Dimensions.

Although the minimum opening dimensions required for height and width are 380 mm, a window opening that is 380 mm by 380 mm would not comply with the minimum area requirements. (See Figure A-9.9.10.1.(1))

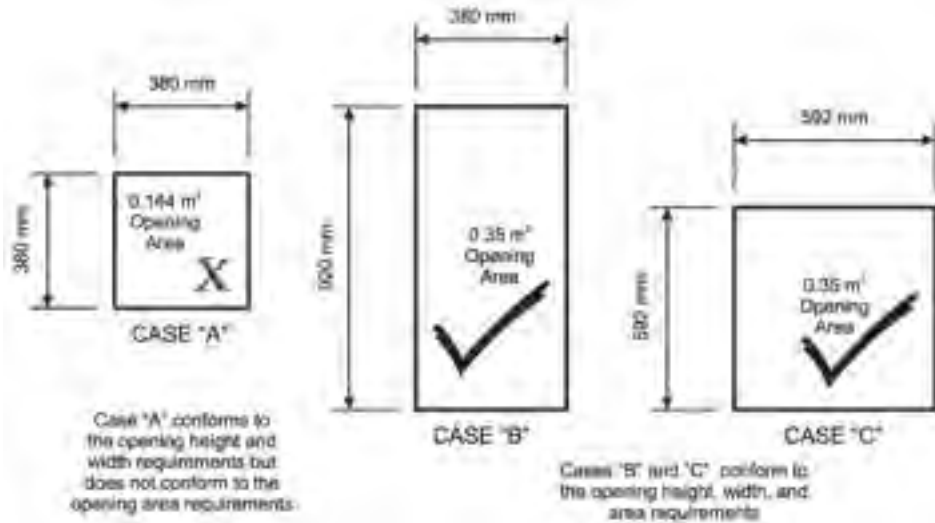


Figure A-9.9.10.1.(1)
Window Opening Areas and Dimensions

A-9.9.10.1.(2) Bedroom Window Height.

Sentence 9.9.10.1.(2) requires every floor level which contains a bedroom to have at least one window or door to the exterior that is large enough and easy enough to open that it can be used as an exit in case of a fire. However, Article 9.9.10.1. does not set a maximum sill height for such a window in a basement area. It is recommended that the sills of windows intended for use as emergency exits from basement bedroom areas be not higher than 1.5 m above the floor. Sometimes it is difficult to avoid having the sill higher than this; e.g., skylights, windows in basement bedrooms. In these cases, it is recommended that access to the window be improved by some means such as built-in furniture installed below the window. (See Figure A-9.9.10.1.(2))

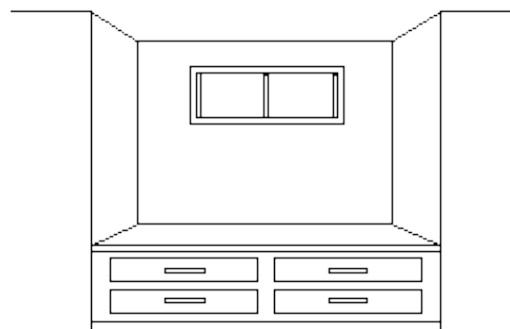


Figure A-9.9.10.1.(2)
Built-in Furniture to Improve Access to a Window

A-9.9.10.1.(5) Window Opening into a Window Well.

Sentence 9.9.10.1.(5) specifies that there must be a minimum clearance of 550 mm in front of designated escape windows to allow persons to escape a basement bedroom in an emergency. This specified minimum clearance is consistent with the minimum required width for means of egress from a floor area (see Article 9.9.5.5.) and the minimum required width for path of travel on exit stairs (see Article 9.9.6.1.). It is considered the smallest acceptable clearance between the escape window and the facing wall of the window well that can accommodate persons trying to escape a bedroom in an emergency given that they are not moving straight through the window but must move outward and up, and must have sufficient space to change body orientation.

Once this clearance is provided, no additional clearance is needed for windows with sliders, casements, or inward-opening awnings. However, for windows with outward-opening awnings, additional clearance is needed to provide the required 550 mm beyond the outer edge of the sash. (See Figure A-9.9.10.1.(5).)

Depending on the likelihood of snow accumulation in the window well, it could be difficult — if not impossible — to escape in an emergency. The window well should be designed to provide sufficient clear space for a person to get out the window and then out the well, taking into account potential snow accumulation.

Hopper windows (bottom-hinged operators) should not be used as escape windows in cases where the occupants would be required to climb over the glass.

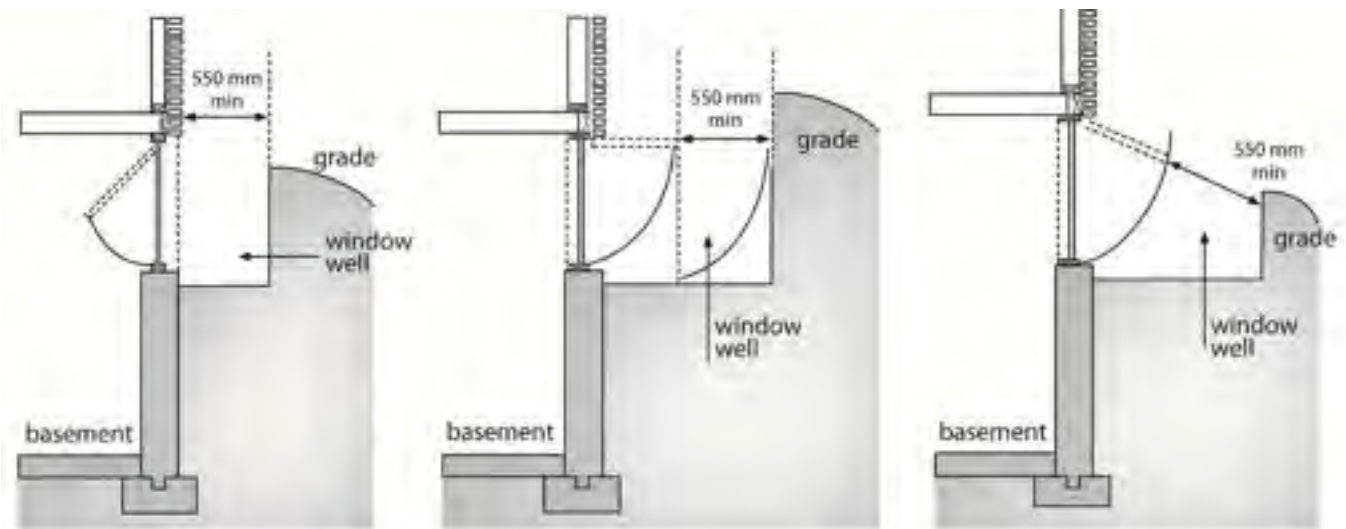


Figure A-9.9.10.1.(5)
Windows Providing a Means of Escape that Open into a Window Well.

A-9.10.1.3.(8) Installation of Sprinkler, Standpipe and Hose Systems.

Some provisions captured by the cross-reference to Part 3 go beyond the intended application of the cross-reference.

In the context of the cross-reference, Subsections 3.2.5. and 3.2.9. apply only where sprinkler, standpipe or hose systems are installed in a Part 9 building, whether the installation is voluntary or for the purpose of complying with the provisions in Part 9. Provisions in Part 3 that identify buildings or spaces in which these systems are to be installed do not apply.

A-9.10.1.4.(1) Commercial Cooking Equipment.

Part 6 refers to NFPA 96, “Installation of Equipment for the Removal of Smoke and Grease-laden Vapours from Commercial Cooking Equipment”, which in turn references “Commercial Cooking Equipment”. However, the deciding factor as to whether or not NFPA 96 applies is the potential for production of grease-laden vapours and smoke, rather than the type of equipment used. While NFPA 96 does not apply to domestic equipment for normal residential family use, it should apply to

domestic equipment used in commercial, industrial, institutional and similar cooking applications where the potential for the production of smoke and grease-laden vapours exceeds that for normal residential family use.

A-9.10.3.1.(1) Fire and Sound Resistance of Building Assemblies.

The Tables found in MMAH Supplementary Standard SB-3 may be used to select building assemblies for compliance with Article 9.10.3.1. and Subsection 9.11.2. Assemblies not listed in those Tables are equally acceptable provided their fire and sound resistance can be demonstrated to meet the above-noted requirements on the basis of tests referred to in 9.10.3.1. and 9.11.1. or by using the data in MMAH Supplementary Standard SB-2.

A-9.10.9.6.(1) Penetration of Fire-Rated Assemblies by Service Equipment.

This Sentence, together with Article 3.1.9.1., is intended to ensure that the integrity of fire-rated assemblies is maintained where they are penetrated by various types of service equipment.

For buildings regulated by the requirements in Part 3, fire stop materials used to seal openings around building services, such as pipes, ducts and electrical outlet boxes, must meet a minimum level of performance demonstrated by standard test criteria.

This is different from the approach in Part 9. Because of the type of construction normally used for buildings regulated by the requirements in Part 9, it is assumed that this requirement is satisfied by the use of generic fire stop materials such as mineral wool, gypsum plaster or Portland cement mortar.

Also, see Appendix Note A-3.1.9.

A-9.10.9.16.(4) Separation Between Dwelling Units and Garages.

The gas-tight barrier between a dwelling unit and an attached garage is intended to provide reasonable protection from carbon monoxide and gasoline fumes entering the dwelling unit. Construction assemblies incorporating an air barrier system will perform adequately with respect to gas tightness, provided reasonable care is exercised where the wall or ceiling is pierced by building services. Where a garage is open to the adjacent attic space above the dwelling unit it serves, a gas-tight barrier in the dwelling unit ceiling will also provide protection. Unit masonry walls forming the separation between a dwelling unit and an adjacent garage should be provided with two coats of sealer or plaster or covered with gypsum wallboard on the side of the wall exposed to the garage. All joints must be sealed to ensure continuity of the barrier. (See also Sentences 9.25.3.3.(3) to (8).)

Also, see Appendix Note A-3.1.9.

A-9.10.12.4.(1) Protection of Overhang of Common Roof Space.

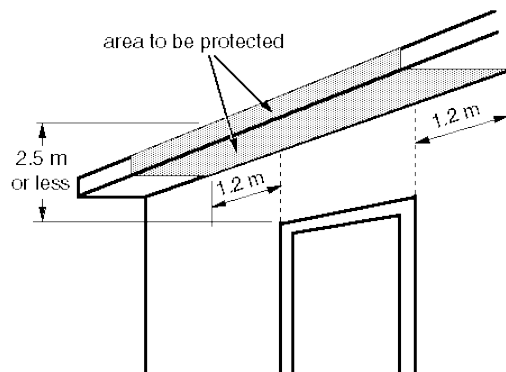


Figure A-9.10.12.4.(1)
Protection of Overhang of Common Roof Space

A-9.10.12.4.(3) Protection at Soffits.

The materials required by this Sentence to be used as protection for soffit spaces in certain locations do not necessarily have to be the finish materials. They can be installed either behind the finishes chosen for the soffits or in lieu of these.

A-9.10.13.2.(1) Wood Doors in Fire Separations.

CAN/ULC-S113, “Wood Core Doors Meeting the Performance Required by CAN/ULC-S104 for Twenty Minute Fire Rated Closure Assemblies” provides construction details to enable manufacturers to build wood core doors that will provide a 20 min fire-protection rating without the need for testing. The Standard requires each door to be marked with

- (1) manufacturer’s or vendor’s name or identifying symbol,
- (2) the words “Fire Door”, and
- (3) a reference to the fire-protection rating of 20 min.

as A-9.10.15.1.(1) Application of Subsection 9.10.15.

Subsection 9.10.15. applies to the spatial separation between houses which may contain one dwelling unit above another. The designer has the option of using either Subsection 9.10.14. or Subsection 9.10.15. for the determination of spatial separation requirements for these types of buildings. However, the requirements of these two Subsections cannot be mixed.

The buildings to which Subsection 9.10.15. applies include:

- traditional individual detached houses with or without a second dwelling unit,
- semi-detached houses (doubles) where each house may contain a second dwelling unit,
- row houses, where any house may contain a second dwelling unit, and
- stacked dwelling units where one of them is a second dwelling unit in a house.

Subsection 9.10.15. does not apply to stacked row houses/townhouses or stacked dwelling units that are not within a house.

A-9.10.15.4.(2) Staggered or Skewed Exposing Building Faces of Houses.

Studies at the National Fire Laboratory of the National Research Council have shown that, where an exposing building face is stepped back from the property line or is at an angle to the property line, it is possible to increase the percentage of glazing in those portions of the exposing building face further from the property line without increasing the amount of radiated energy that would reach the property line in the event of a fire in such a building. Figures A-9.10.15.4.(2)-A to A-9.10.15.4.(2)-C show how Sentences 9.10.15.4.(1) and (2) could be applied to exposing building faces that are stepped back from or not parallel to the property line.

The following procedure can be used to establish the maximum permitted area of glazed openings for such facades:

1. Calculate the total area of the exposing building face, i.e. facade of the fire compartment, as described in the definition of exposing building face.
2. Identify the portions into which the exposing building face is to be divided. It can be divided in any number of portions, not necessarily of equal size.
3. Measure the limiting distance for each portion. The limiting distance is measured along a line perpendicular to the wall surface from the point closest to the property line.
4. Establish the line in Table 9.10.15.4. from which the maximum permitted percentage area of glazed openings will be read. The selection of the line depends on the maximum area of exposing building face for the whole fire compartment, including all portions, as determined in Step 1.
5. On that line, read the maximum percentage area of glazed openings permitted in each portion of the exposing building face according to the limiting distance for that portion.
6. Calculate the maximum area of glazed openings permitted in each portion. The area is calculated from the percentage found applied to the area of that portion.

Table 9.10.15.4. is used to determine the maximum area of glazed openings. Therefore, unglazed portions of doors need not be counted, as for other types of buildings.

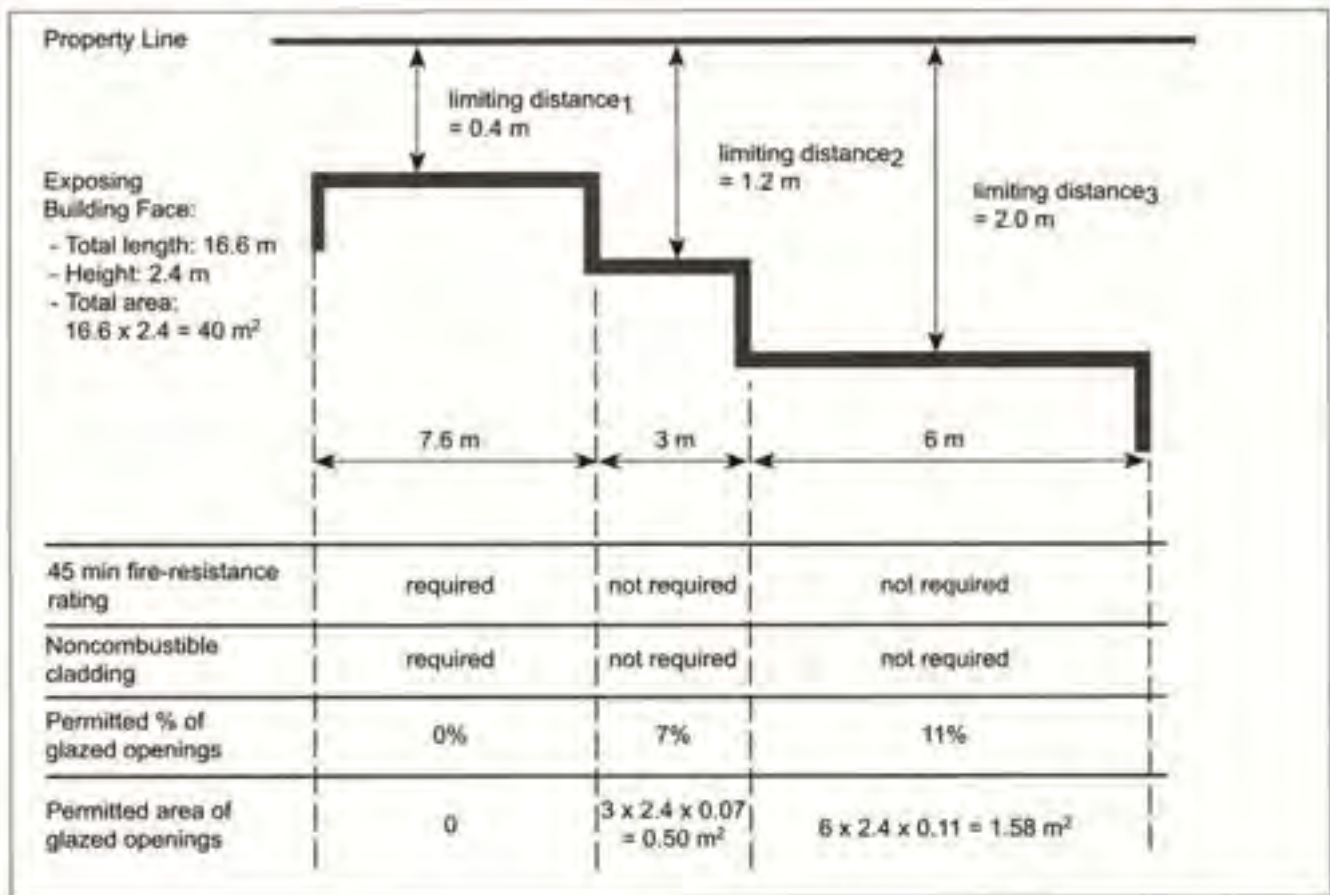


Figure A-9.10.15.4.(2)-A
 Example of Determination of Criteria for the Exposing Building Face of a Staggered Wall of a House

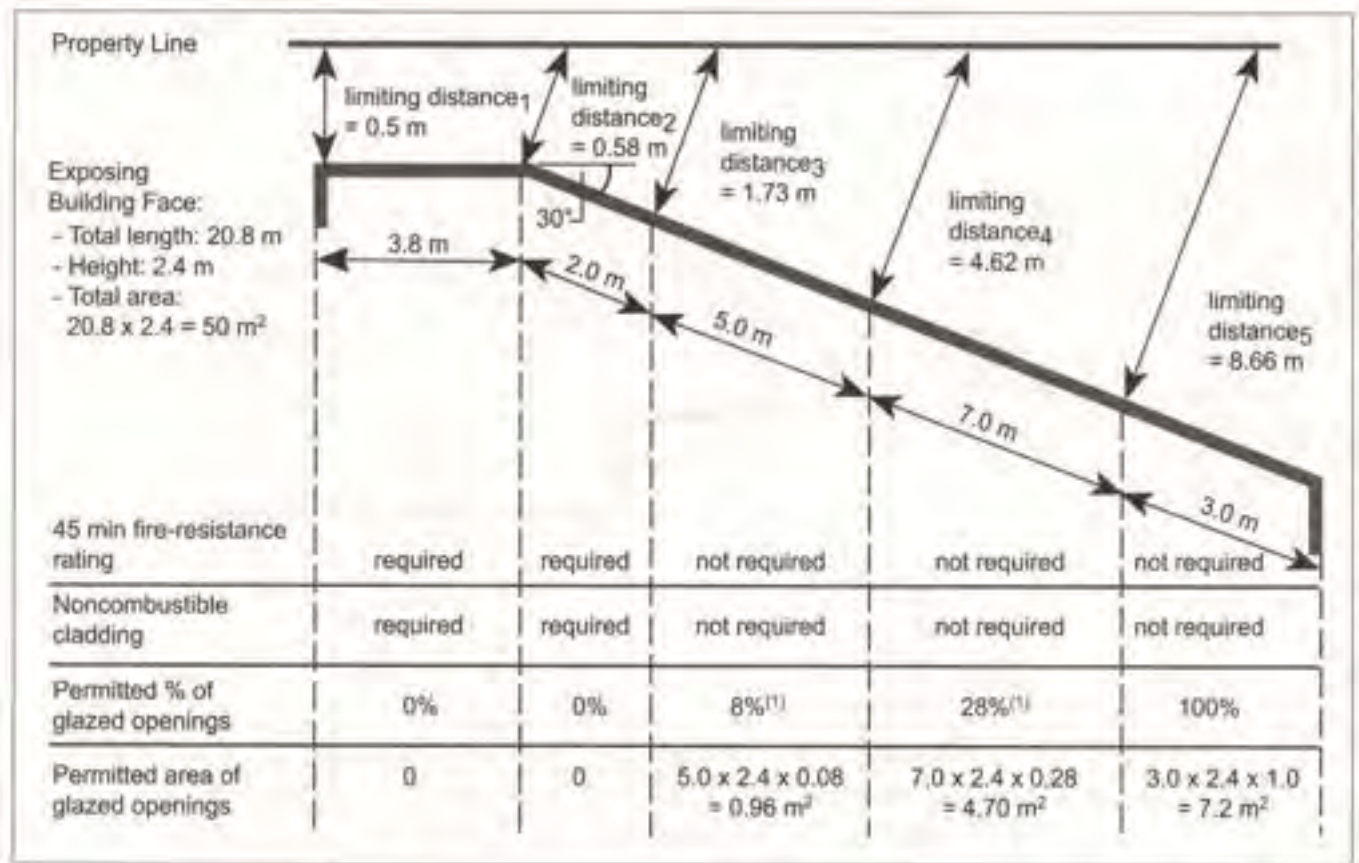


Figure A-9.10.15.4.(2)-B
Example of Determination of Criteria for the Exposing Building Face of a Skewed Wall of a House With Some Arbitrary Division of the Wall

Note to Figure A-9.10.15.4.(2)-B:

- (1) To simplify the calculations, choose the column for the lesser limiting distance nearest to the actual limiting distance. Interpolation for limiting distance is also acceptable and may result in a slightly larger permitted area of glazed openings. Interpolation can only be used for limiting distances greater than 1.2 m.

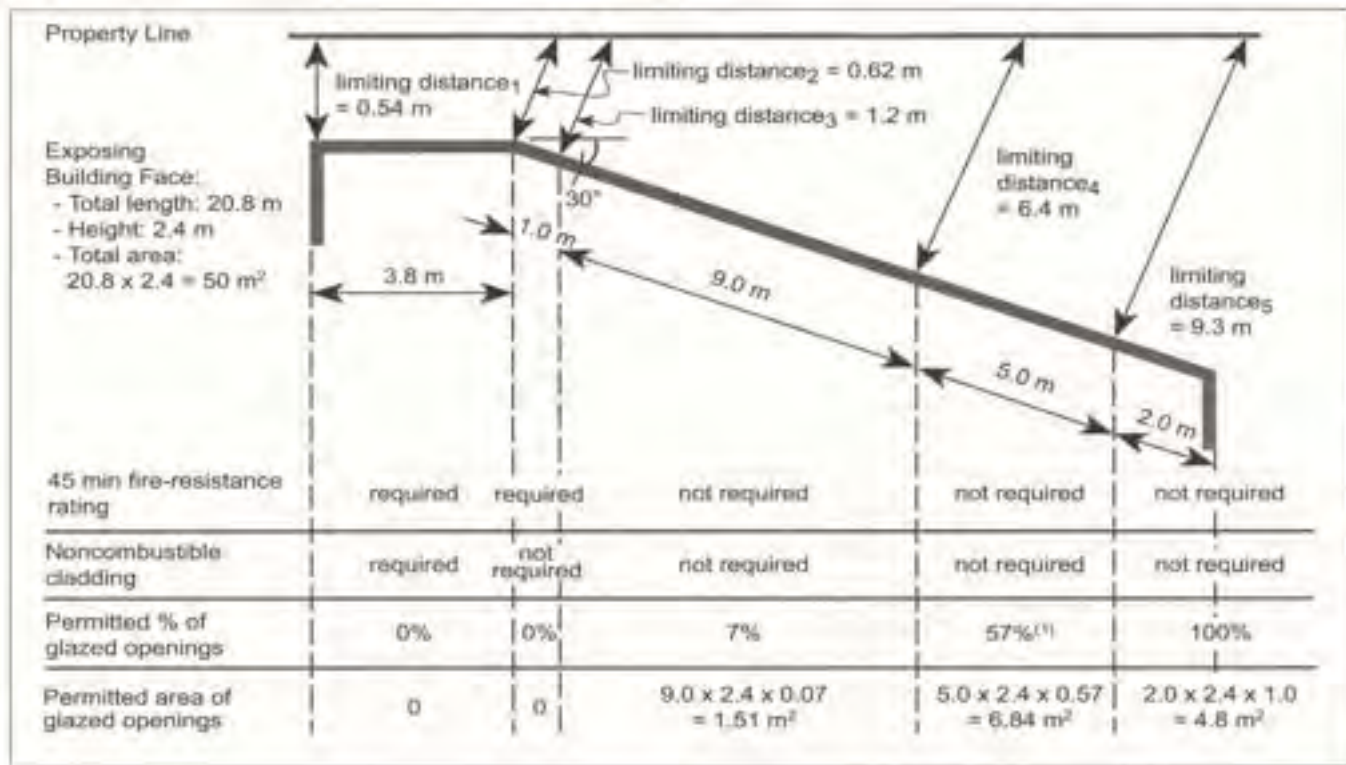


Figure A-9.10.15.4.(2)-C
 Example of Determination of Criteria for the Exposing Building Face of a Skewed Wall of a House With a Different Arbitrary Division of the Wall

Note to Figure A-9.10.15.4.(2)-C:

(1) To simplify the calculations, choose the column for the lesser limiting distance nearest to the actual limiting distance. Interpolation for limiting distance is also acceptable and may result in a slightly larger permitted area of glazed openings. Interpolation can only be used for limiting distances greater than 1.2 m.

A-9.10.18.3.(1) Fire Alarm, Fire Detection and Smoke Detection Devices and Systems.

A number of provisions captured by the cross-reference to Subsection 3.2.4. address issues already addressed in Subsection 9.10.18. and so are not applicable to Part 9 buildings. For example, Articles 9.10.18.2. and 9.10.18.8. identify the Part 9 buildings where fire alarm systems are required, so Article 3.2.4.1. does not apply.

Note that, because the cross-reference relating to sprinkler systems in Sentence 9.10.1.3.(8) refers to conformance with Sentence 3.2.5.7.(1), Articles 3.2.5.13. to 3.2.5.16. and Article 3.2.5.18., the requirements of Subsection 3.2.4. regarding electrical supervision and monitoring do not normally apply to sprinkler systems in Part 9 buildings. However, where a sprinkler system is installed in lieu of heat and smoke detectors according to Sentence 9.10.18.4.(3) electrical supervision and monitoring of the sprinkler system must comply with the provisions in Subsection 3.2.4.

a3 A-9.10.19.1. and A-9.10.19.3. Smoke Alarms with Visual Signalling Component.

Smoke alarms with a visual signalling component can alert people who are deaf, deafened or hard of hearing to the presence of smoke in the dwelling just as the alarm sound provides an alert to people with no or low vision or who are sighted. The visual signal provides an extra level of safety alerts to building residents.

A-9.10.19.3.(1) Location of Smoke Alarms.

Statistics have shown that next to kitchen fires, fires originating in bedrooms within dwelling units account for the second highest causes of fire deaths in homes.

The requirement for smoke alarms in sleeping rooms (bedrooms) provides early detection and warning of fires originating in sleeping rooms. Smoke alarms located outside sleeping rooms are required as they are better capable of detecting a fire originating outside of the room.

A smoke alarm is not required on each level in a split-level dwelling unit as each level does not count as a separate storey. Determine the number of storeys in a split-level dwelling unit and which levels are part of which storey as follows:

1. establish grade, (See definition of “grade” in Sentence 1.4.1.2.(1) of Division A.);
2. identify the first storey, (See definition of “first storey” in Sentence 1.4.1.2.(1) of Division A.);
3. identify the basement, (See definition of “basement” in Sentence 1.4.1.2.(1) of Division A.);
4. identify the second storey and, where applicable, the third storey.

Additional Smoke Alarms Outside of Sleeping Areas

As a minimum, one smoke alarm is required to be installed on each storey, preferably on the upper level of each one. As noted above, however, when the dwelling unit contains more than one sleeping area, a smoke alarm must be installed to serve each area. Where the sleeping areas are on two levels of a single storey in a split-level dwelling unit, an additional smoke alarm must be installed so that both areas are protected. See Figure A-9.10.19.3.(1).

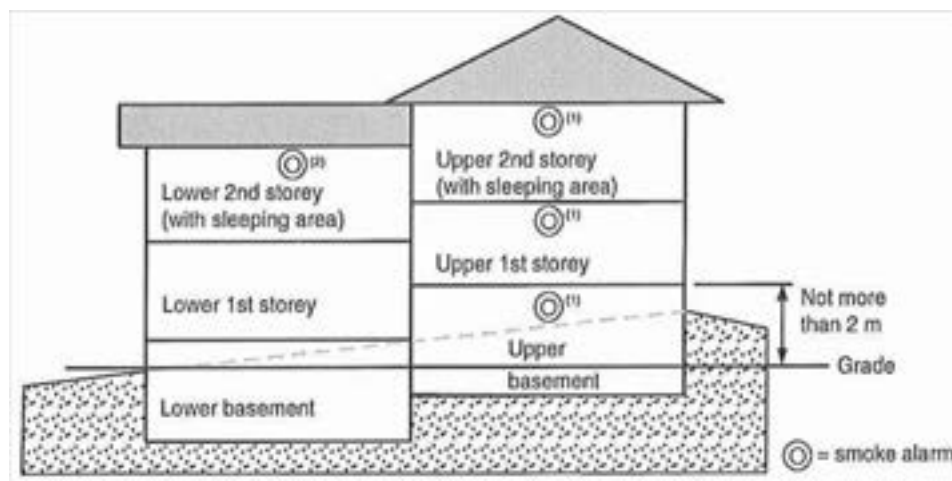


Figure A-9.10.19.3.(1)
Two-Storey Split-Level Building

Notes to Figure A-9.10.19.3.(1):

- (1) One smoke alarm required for each of the basement, first storey and second storey.
- (2) An additional smoke alarm is required on the lower level of the second storey outside the sleeping rooms.

A-9.10.20.3.(1) Fire Department Access Route Modification.

In addition to other considerations taken into account in the planning of fire department access routes, special variations could be permitted for a house or residential building that is protected with an automatic sprinkler system. The sprinkler system must be designed in accordance with the appropriate NFPA standard and there must be assurance that water supply pressure and quantity are unlikely to fail. These considerations could apply to buildings that are located on the sides of hills and are not conveniently accessible by roads designed for fire fighting equipment and also to infill housing units that are located behind other buildings on a given property.

a10.1 A-9.10.22. Clearances from Gas, Propane and Electric Cooktops.

The Electrical Safety Code adopted under Ontario Regulation 164/99 (Electrical Safety Code), and Ontario Natural Gas Code address clearances directly above, in front of, behind and beside ranges. Where side clearances are zero, the standards do not address clearances to building elements located both above the level of the range elements or burners and to the side of the appliance. Through reference to the Electrical Safety Code adopted under Ontario Regulation 164/99 (Electrical Safety Code) and the requirements in Articles 9.10.22.2. and 9.10.22.3., the Building Code addresses all clearances. Where clearances are addressed by the Building Code and the Electrical Safety Code adopted under Ontario Regulation 164/99 (Electrical Safety Code) or Ontario Natural Gas Code, conformance with all relevant criteria is achieved by compliance with the most stringent criteria.

Installation of Microwave Ovens Over Cooktops

The minimum vertical clearances stated in Article 9.10.22.2. apply only to combustible framing, finishes and cabinets. They do not apply to microwave ovens installed over cooktops nor to range hoods. Microwave ovens must comply with CAN/CSA-C22.2 NO. 150, "Microwave Ovens", which is referenced in the Electrical Safety Code adopted under Ontario Regulation 164/99 (Electrical Safety Code). This standard includes tests to confirm that the appliance will not present a hazard when installed according to the manufacturer's instructions.

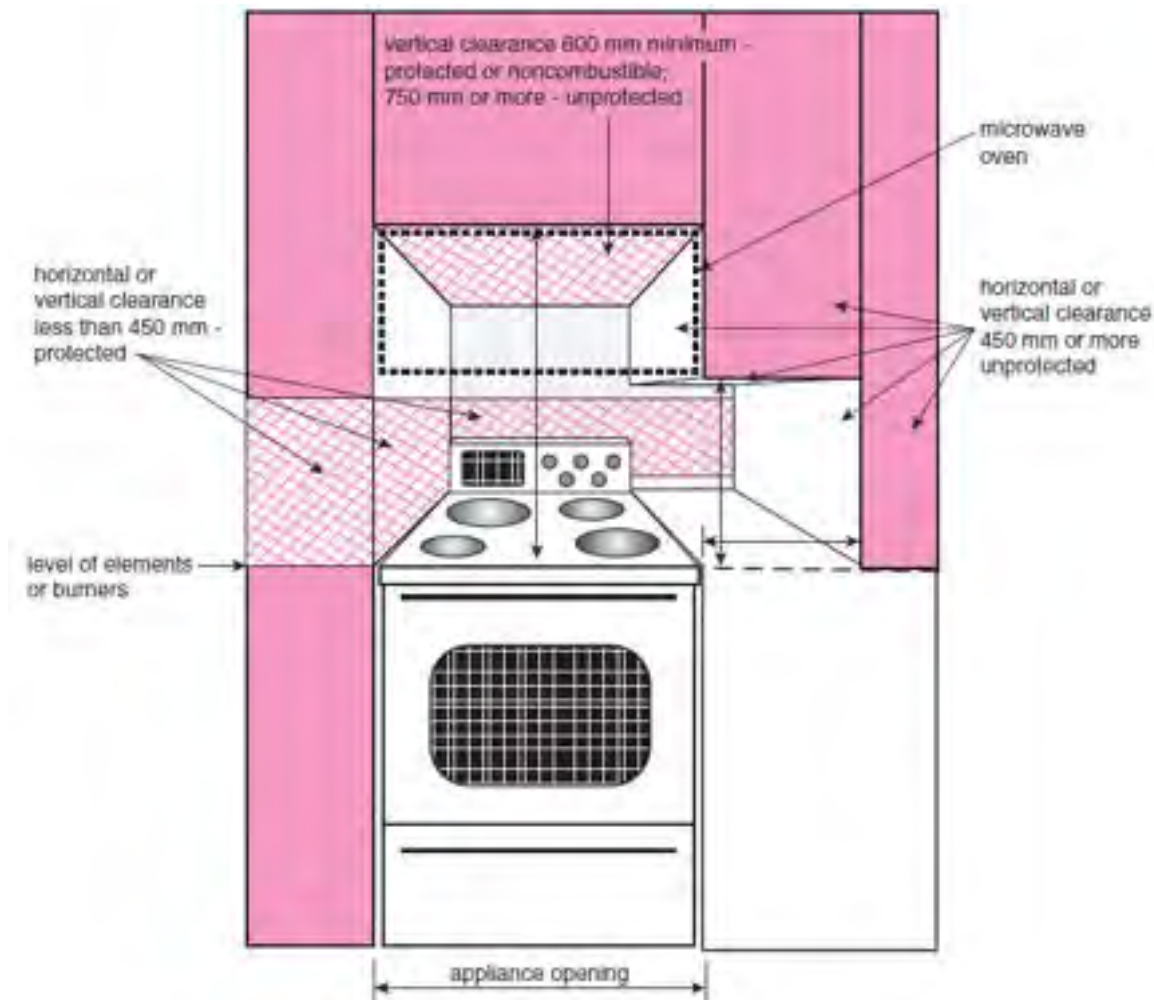


Figure A-9.10.22.
Clearances from Cooktops to Walls and Cabinetry

a10.1 A-9.11. Sound Transmission.
Airborne Sound

Airborne sound is transmitted between adjoining spaces directly through the separating wall, floor and ceiling assemblies and via the junctions between these separating assemblies and the flanking assemblies.

The Sound Transmission Class (STC) rating describes the performance of the separating wall or floor/ceiling assembly, whereas the Apparent Sound Transmission Class (ASTC) takes into consideration the performance of the separating element as well as the flanking transmission paths. Therefore, from the occupants' point of view, the best indicator of noise protection between the two spaces is the ASTC rating.

As a key principle, it is important to follow a “whole system” approach when designing or constructing assemblies that separate dwelling units because the overall sound performance of walls and floors is also influenced by fire protection measures and the structural design of the assemblies. Likewise, changes to the construction of assemblies to meet sound transmission requirements may have fire and structural implications. Another key principle is that enhancing the performance of the separating element does not automatically enhance the system's performance.

For horizontally adjoining spaces, the separating assembly is the intervening wall and the pertinent flanking surfaces include those of the floor, ceiling, and side wall assemblies that have junctions with the separating wall assembly, normally at its four edges. For each of these junctions, there are a set of sound transmission paths. Figure A-9.11.A. illustrates the horizontal sound transmission paths at the junction of a separating wall with flanking floor assemblies.

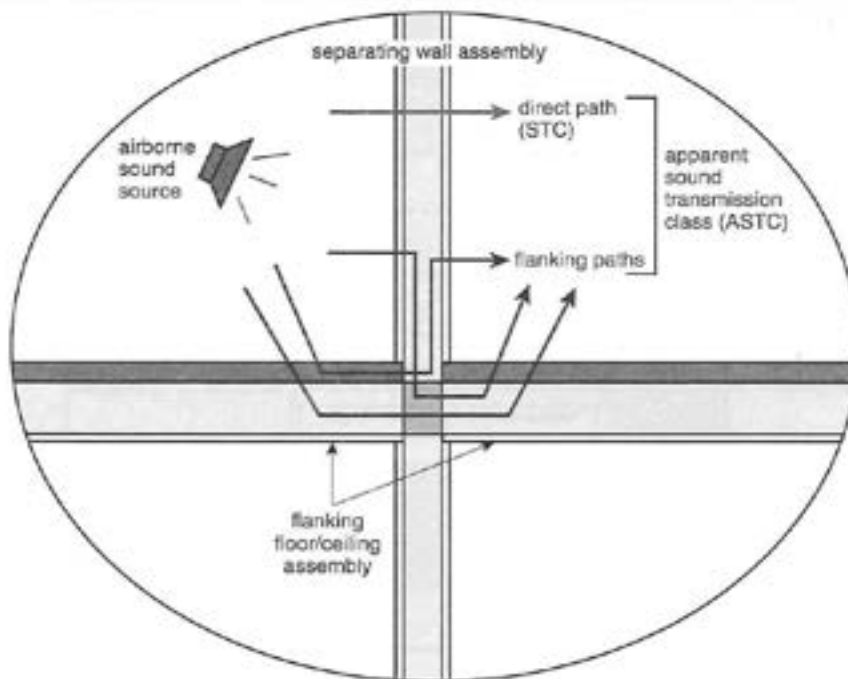


Figure A-9.11.A.
Horizontal Sound Transmission Paths Floor/Wall Junction

For vertically adjoining spaces, the separating assembly is the intervening floor/ceiling and the pertinent flanking surfaces include those of the side wall assemblies in the upper and lower rooms that have junctions with the separating floor/ceiling assembly at its edges, of which there are normally four. For each of these junctions, there is a set of sound transmission paths. Figure A-9.11.B. illustrates the vertical sound transmission paths at the junction of a separating floor/ceiling assembly with two flanking wall assemblies.

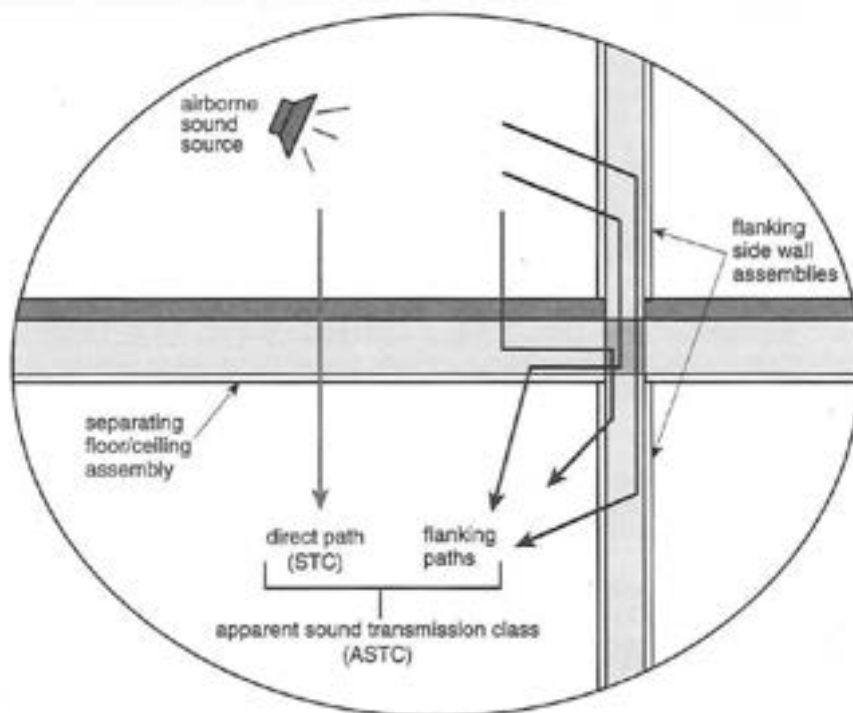


Figure A-9.11.B.
Vertical Sound Transmission Paths Floor/Wall Junction

Control of Sound Leaks

The metrics used to characterize the sound transmission performance of assemblies separating dwelling units do not account for the adverse effects of air leaks in those assemblies, which can transfer sound. Sound leaks can occur where a wall meets another wall, the floor, or the ceiling. They can also occur where the wall finish is cut for the installation of equipment or services. The following are examples of measures for controlling sound leaks:

- Avoid back-to-back electrical outlets or medicine cabinets;
- Carefully seal cracks or openings so structures are effectively airtight;
- Apply sealant below the plates in stud walls, between the bottom of gypsum board sheets and the structure behind, around all penetrations for services and, in general, wherever there is a crack, a hole or the possibility of one developing;
- Include sound-absorbing material inside the wall if not already required.

The reduction of air leakage is also addressed to some extent by the smoke tightness requirements in the Code.

The calculation of and laboratory testing for STC and ASTC ratings are performed on intact assemblies having no penetrations or doors. When measuring ASTC ratings in the field, openings can be blocked with insulation and drywall.

To verify that the required acoustical performance is being achieved, a field test can be done at an early stage in the construction; ASTM E336, "Measurement of Airborne Sound Attenuation Between Rooms in Buildings" gives a complete measurement. A simpler and less expensive method is presented in ASTM E597, "Determining a Single Number Rating of Airborne Sound Insulation for Use in Multi-Unit Building Specifications". The rating derived from this test is usually within 2 points of the STC obtained from ASTM E336. It is useful for verifying performance and finding problems during construction. Alterations can then be made prior to project completion.

Impact Noise

Section 9.11. has no requirements for control of impact noise transmission. Footstep and other impacts can cause severe annoyance in multi-family residences. Builders concerned about quality and reducing occupant complaints will ensure that floors are designed to minimize impact transmission. A recommended criterion is that bare floors (tested without a carpet) should achieve an impact insulation class (IIC) of 55. Some lightweight floors that satisfy this requirement may still cause complaints about low frequency impact noise transmission. Adding carpet to a floor will always increase the IIC rating but will not necessarily reduce low frequency noise transmission. Good footstep noise rejection requires fairly heavy floor slabs or floating floors.

Most frequently used methods of test for impact noise are ASTM E492, “Laboratory Measurement of Impact Sound Transmission Through Floor-Ceiling Assemblies Using The Tapping Machine”, or ASTM E1007, “Field Measurement of Tapping Machine Impact Sound Transmission Through Floor-Ceiling Assemblies and Associated Support Structures”.

Machinery Noise

Elevators, garbage chutes, plumbing, fans, and heat pumps are common sources of noise in buildings. To reduce annoyance from these, they should be placed as far as possible from sensitive areas. Vibrating parts should be isolated from the building structure using resilient materials such as neoprene or rubber.

a10.1 A-9.11.1.3.(2)(b) Control of Airborne Noise in Buildings.

Tables 1 and 2 of MMAH Supplementary Standard SB-3, “Fire and Sound Resistance of Building Assemblies” present separating assemblies that comply with Subsection 9.11. However, selecting an appropriate separating assembly is only one part of the solution for reducing airborne sound transmission between adjoining spaces. To fully address the sound performance of the whole system, flanking assemblies must be connected to the separating assembly in accordance with Article 9.11.1.4.

a10.1 A-9.11.1.4. Adjoining Construction.

Tables A-9.11.1.4.A. to A-9.11.1.4.D. present generic options for the design and construction of junctions between separating and flanking assemblies. Constructing according to these options is likely to meet or exceed an ASTC rating of 47. Other designs may be equally acceptable if their sound resistance can be demonstrated to meet the minimum ASTC rating or better on the basis of tests referred to in Article 9.11.1.2., or if they comply with Subsection 5.8.1. However, some caution should be applied when designing solutions that go beyond the options provided in these Tables: for example, adding more material to a wall could negatively impact its sound performance or have no effect at all.

Table A-9.11.1.4.A. presents compliance options for the construction of separating wall assemblies with flanking floor, ceiling and wall assemblies in horizontally adjoining spaces.

Table A-9.11.1.4.B. presents options for improving the sound performance of separating wall systems beyond that achieved by implementing the options presented in Table A-9.11.1.4.A. The suggested performance improvement options are listed in order of approximate acoustic priority and are interdependent, i.e., if options at the top of the list are not implemented, then options at the bottom of the list will have much lesser effect.

Table A-9.11.1.4.C. presents compliance options for the construction of separating floor/ceiling assemblies with flanking wall assemblies in vertically adjoining spaces.

Table A-9.11.1.4.D. presents options for improving the sound performance of separating floor/ceiling assemblies beyond that achieved by implementing the options presented in Table A-9.11.1.4.C. The suggested performance improvement options are listed in order of approximate acoustic priority and are interdependent, i.e., if options at the top of the list are not implemented, then options at the bottom of the list will have much lesser effect.

Table A-9.11.1.4.A.
Options for the Design and Construction of Junctions and Flanking Surfaces Between Separating Wall Assemblies in Horizontally Adjoining Spaces for Compliance with Clause 9.11.1.1.(1)(b)

Type of Separating Wall Assembly with STC ≥ 50 from Table 1 of MMAH Supplementary Standard SB-3	Options for Design and Construction of Junctions and Flanking Surfaces ⁽¹⁾ to Address Horizontal Sound Transmission Paths		
	Bottom Junction (between separating wall and flanking floors)	Top Junction (between separating wall and flanking ceiling)	Side Junctions (between separating wall and flanking walls)
W4, W5, W6 (single stud) W8, W9, W10, W11, W12 (staggered studs)	<ul style="list-style-type: none"> for additional material layer and finished flooring, see Table 9.11.1.4. subfloor on both sides of wall is plywood, OSB, waferboard (15.5 mm thick) or tongue and groove lumber (≥ 17 mm thick) floor is framed with wood joists, wood I-joists or wood trusses spaced ≥ 406 mm o.c., with or without absorptive material⁽²⁾ in cavities floor joists or trusses are oriented parallel to separating wall (non-loadbearing case) or perpendicular to separating wall but are not continuous across junction (loadbearing case) 	<ul style="list-style-type: none"> ceiling is framed with wood joists, wood I-joists, or wood trusses, with or without absorptive material⁽²⁾ in cavities ceiling joists or trusses are oriented perpendicular to separating wall but are not continuous across junction (loadbearing case) or parallel to junction (non-loadbearing case) gypsum board ceiling is fastened directly to bottom of ceiling framing or on resilient metal channels⁽³⁾ 	<ul style="list-style-type: none"> gypsum board on flanking walls ends or is cut at separating wall and is fastened directly to framing or on resilient metal channels⁽³⁾ flanking wall is framed with single row of wood studs, staggered studs on a single 38 mm x 140 mm plate, or 2 rows of 38 mm x 89 mm wood studs on separate 38 mm x 89 mm plates, with or without absorptive material⁽²⁾ in cavities flanking wall framing is structurally connected to separating wall and terminates where it butts against framing of separating wall or is continuous across junction
	<p>Example Showing Side View of Bottom and Top Junctions</p>	<p>Example Showing Plan View of Side Junctions</p>	

Table A-9.11.1.4.A. (Cont'd)
Options for the Design and Construction of Junctions and Flanking Surfaces Between Separating Wall Assemblies in Horizontally Adjoining Spaces for Compliance with Clause 9.11.1.1.(1)(b)


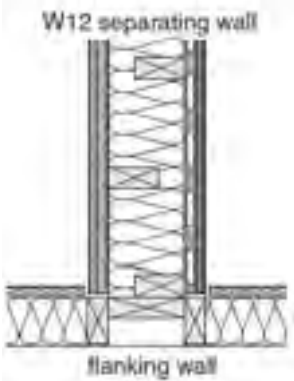
Type of Separating Wall Assembly with STC ≥ 50 from Table 1 of MMAH Supplementary Standard SB-3	Options for Design and Construction of Junctions and Flanking Surfaces ⁽¹⁾ to Address Horizontal Sound Transmission Paths		
	Bottom Junction (between separating wall and flanking floors)	Top Junction (between separating wall and flanking ceiling)	Side Junctions (between separating wall and flanking walls)
<p>W4, W5, W6 (single stud)</p> <p>W8, W9, W10, W11, W12 (staggered studs)</p>	<p>Example Showing Side View of Bottom and Top Junctions</p> 		<p>Example Showing Plan View of Side Junctions</p> 
<p>W13, W14, W15</p>	<ul style="list-style-type: none"> • for additional material layer and finished flooring, see Table 9.11.1.4. • subfloor on both sides of wall is plywood, OSB, waferboard (15.5 mm thick) or tongue and groove lumber (≥ 17 mm thick) • floor is framed with wood joists, wood I-joists or wood trusses spaced ≥ 400 mm o.c., with or without absorptive material⁽²⁾ in cavities • floor joists or trusses are oriented parallel to separating wall (non-loadbearing case) or perpendicular to separating wall but are not continuous across junction (loadbearing case) • near leaf of separating wall is supported on "designated" joist 	<ul style="list-style-type: none"> • wood joists, wood I-joists or wood trusses are oriented perpendicular or parallel to separating wall, with or without absorptive material⁽²⁾ in cavities • joist framing at junction is supported on near leaf of separating wall • gypsum board ceiling panels end at wall framing and are fastened directly to bottom of ceiling framing or on resilient metal channels⁽³⁾ 	<ul style="list-style-type: none"> • flanking wall framing is fastened to adjacent leaf of separating wall • flanking wall is framed with single row of wood studs, staggered studs on a single 38 mm x 140 mm plate, or 2 rows of 38 mm x 89 mm wood studs on separate 38 mm x 89 mm plates, with or without absorptive material⁽²⁾ in cavities • gypsum board panels on flanking walls ends or is cut at framing of separating wall and is fastened on resilient metal channels⁽³⁾ or directly to framing of flanking wall if that framing and any sheathing are not continuous across the junction

Table A-9.11.1.4.A. (Cont'd)
Options for the Design and Construction of Junctions and Flanking Surfaces Between Separating Wall Assemblies in Horizontally Adjoining Spaces for Compliance with Clause 9.11.1.1.(1)(b)

Type of Separating Wall Assembly with $STC \geq 50$ from Table 1 of MMAH Supplementary Standard SB-3	Options for Design and Construction of Junctions and Flanking Surfaces ⁽¹⁾ to Address Horizontal Sound Transmission Paths		
	Bottom Junction (between separating wall and flanking floors)	Top Junction (between separating wall and flanking ceiling)	Side Junctions (between separating wall and flanking walls)
W13, W14, W15	<p>Example Showing Side View of Bottom and Top Junctions</p>		<p>Example Showing Plan View of Side Junctions</p>

Table A-9.11.1.4.A. (Cont'd)
Options for the Design and Construction of Junctions and Flanking Surfaces Between Separating Wall Assemblies in Horizontally Adjoining Spaces for Compliance with Clause 9.11.1.1.(1)(b)

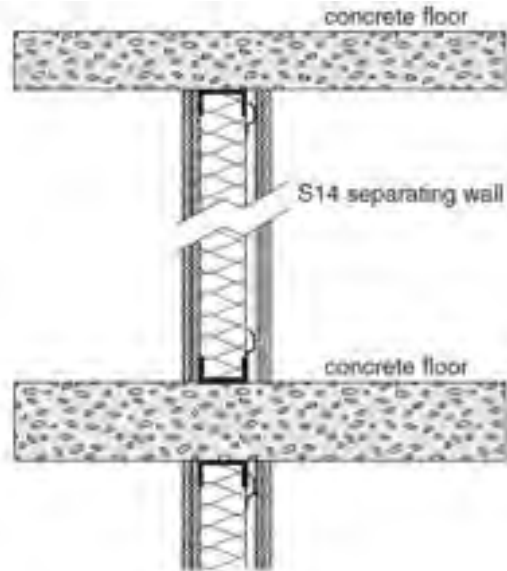
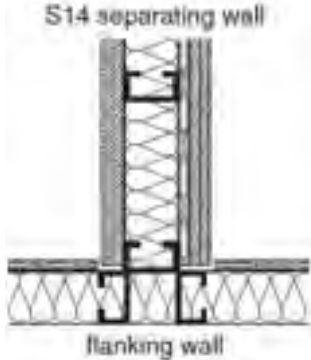
Type of Separating Wall Assembly with $STC \geq 50$ from Table 1 of MMAH Supplementary Standard SB-3	Options for Design and Construction of Junctions and Flanking Surfaces ⁽¹⁾ to Address Horizontal Sound Transmission Paths		
	Bottom Junction (between separating wall and flanking floors)	Top Junction (between separating wall and flanking ceiling)	Side Junctions (between separating wall and flanking walls)
S1 to S15	<ul style="list-style-type: none"> • F1 concrete floor assembly from Table 2 with mass per area not less than 300 kg/m^2 (e.g. normal-weight concrete with average thickness of 130 mm) • with or without an additional material layer or finished flooring 	<ul style="list-style-type: none"> • F1 concrete floor assembly from Table 2 with mass per area not less than 300 kg/m^2 (e.g. normal-weight concrete with average thickness of 130 mm) • with or without gypsum board ceiling suspended below concrete floor 	<ul style="list-style-type: none"> • flanking wall framing is structurally connected to separating wall and terminates where it butts against framing of separating wall or is continuous across junction • gypsum board on flanking walls ends or is cut at separating wall and is fastened directly to framing or on resilient metal channels⁽³⁾ • flanking wall consists of steel framing (loadbearing or non-loadbearing steel studs) or concrete blocks with mass per area not less than 200 kg/m^2 (e.g. normal-weight hollow core concrete block units⁽⁴⁾ with a gypsum board lining supported on framing providing a cavity not less than 50 mm deep) • with or without absorptive material⁽²⁾ in cavities behind gypsum board of flanking walls
	<p>Example Showing Side View of Bottom and Top Junctions</p> 		<p>Example Showing Plan View of Side Junctions</p> 

Table A-9.11.1.4.A. (Cont'd)
Options for the Design and Construction of Junctions and Flanking Surfaces Between Separating Wall Assemblies in Horizontally Adjoining Spaces for Compliance with Clause 9.11.1.1.(1)(b)

Type of Separating Wall Assembly with $STC \geq 50$ from Table 1 of MMAH Supplementary Standard SB-3	Options for Design and Construction of Junctions and Flanking Surfaces ⁽¹⁾ to Address Horizontal Sound Transmission Paths		
	Bottom Junction (between separating wall and flanking floors)	Top Junction (between separating wall and flanking ceiling)	Side Junctions (between separating wall and flanking walls)
B1 to B10	<ul style="list-style-type: none"> • same options as stated above for walls S1 to S15 	<ul style="list-style-type: none"> • same options as stated above for walls S1 to S15 • junction at top of concrete block assembly is loadbearing or non-loadbearing resilient joint 	<ul style="list-style-type: none"> • same options as stated above for walls S1 to S15
	Example Showing Side View of Bottom and Top Junctions		Examples Showing Plan View of Side Junctions

Notes to Table A-9.11.1.4.A.:

- (1) See also Table A-9.11.1.4.B.
- (2) Sound absorptive material is porous (closed-cell foam was not tested) and includes fibre processed from rock, slag, glass or cellulose fibre with a maximum density of 32 kg/m³. See Notes (3) and (6) of Table 1 and Note (4) of Table 2 of MMAH Supplementary Standard SB- 3, "Fire and Sound Resistance of Building Assemblies" for additional information.
- (3) Resilient metal channels are formed from steel having a maximum thickness of 0.46 mm (25 gauge) with slits or holes in the single "leg" between the faces fastened to the framing and to the gypsum board (see Figure 4 in MMAH Supplementary Standard SB-3). ASTM C754, "Installation of Steel Framing Members to Receive Screw-Attached Gypsum Panel Products", describes the installation of resilient metal channels.
- (4) Normal-weight concrete block units conforming to CSA A165.1, "Concrete Block Masonry Units", have aggregate with a density not less than 2 000 kg/m³; 190 mm hollow core units are 53% solid, providing a wall mass per area over 200 kg/m²; 140 mm hollow core units are 75% solid, providing a wall mass per area over 200 kg/m².

Table A-9.11.1.4.B.
Options for the Construction of a Separating Wall System to Further Improve
the Sound Insulation Performance Achieved with the Options in Table A-9.11.1.4.A.

Type of Separating Wall Assembly with $STC \geq 50$ from Table 1 of MMAH Supplementary Standard SB-3	Performance Improvement Options for Junctions Between Separating Walls and Flanking Floor/Ceiling Assemblies
W4, W5, W6, W8, W9, W10, W11, W12	<ul style="list-style-type: none"> • Increase mass per area of additional material layer and finished flooring over subfloor (e.g. concrete or gypsum concrete topping) • Choose separating wall assembly with higher STC rating • Orient floor and ceiling joists parallel to separating wall (non-loadbearing case) • Add resilient layer under additional material layer over subfloor or between additional material layer and finished flooring • Support gypsum board panels of ceiling on resilient metal channels⁽¹⁾ • Support gypsum board panels of flanking walls on resilient metal channels⁽¹⁾
W13, W14, W15	<ul style="list-style-type: none"> • If seismic or other structural requirements permit, choose a fire block detail at floor/wall junction in accordance with Subsection 9.10.16. that does not provide a rigid connection between the two rows of framing of the separating wall (e.g. subfloor not continuous across junction and semi-rigid fibre insulation board filling the gap in accordance with Article 9.10.16.3.). In this case, an additional material layer would not be necessary. Also, choose separating wall assembly with higher STC rating (e.g. more absorptive material⁽²⁾ in cavities and/or more gypsum board). • If having a rigid structural connection at the floor/wall junction (such as subfloor continuous across the junction) is required for seismic or other structural reasons, obtain a higher ASTC rating as follows: <ul style="list-style-type: none"> • Increase combined mass per area of additional material layer over subfloor and finished flooring (e.g. concrete or gypsum concrete topping) • Choose separating wall assembly with higher STC rating (e.g. more absorptive material⁽²⁾ and/or more gypsum board) • Support gypsum board panels of ceiling on resilient metal channels⁽¹⁾ • Support gypsum board panels of flanking walls on resilient metal channels⁽¹⁾ • Add resilient layer under additional material layer over subfloor or between additional material layer and finished flooring
S1 to S15	<ul style="list-style-type: none"> • Choose separating wall assembly with higher STC rating • Increase thickness of concrete floor slab and/or add material layer and finished flooring over subfloor • Add gypsum board ceiling on framing supported under the floor above, with cavity not less than 100 mm deep • Add resilient layer under additional material layer over subfloor or between additional material layer and finished flooring • Support gypsum board panels of flanking walls on resilient metal channels⁽¹⁾ if steel studs are loadbearing type

Table A-9.11.1.4.B. (Cont'd)
Options for the Construction of a Separating Wall System to Further Improve
the Sound Insulation Performance Achieved with the Options in Table A-9.11.1.4.A.

Type of Separating Wall Assembly with $STC \geq 50$ from Table 1 of MMAH Supplementary Standard SB-3	Performance Improvement Options for Junctions Between Separating Walls and Flanking Floor/Ceiling Assemblies
B1 to B10	<ul style="list-style-type: none"> • Choose separating wall assembly with higher STC rating • Add gypsum board ceiling supported below concrete floor with cavity not less than 100 mm deep and sound absorptive material⁽²⁾ in cavity • Increase thickness of concrete floor slab and/or add material layer and finished flooring over subfloor • Add resilient layer under additional material layer over subfloor or between additional material layer and finished flooring and increase mass per area of additional material layer and finished flooring (e.g. floating concrete or gypsum concrete topping) • Support gypsum board panels of flanking walls on resilient metal channels⁽¹⁾ if steel studs are loadbearing type

Notes to Table A-9.11.1.4.B.:

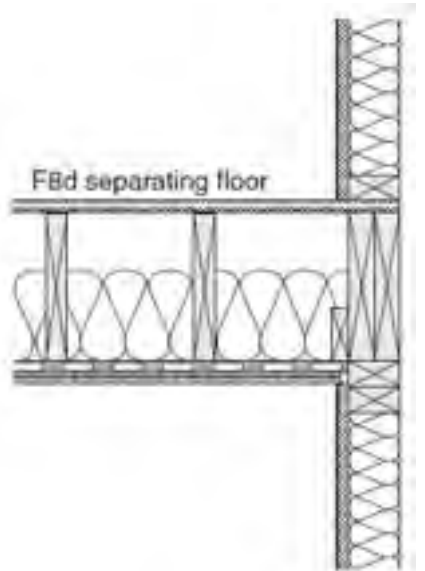
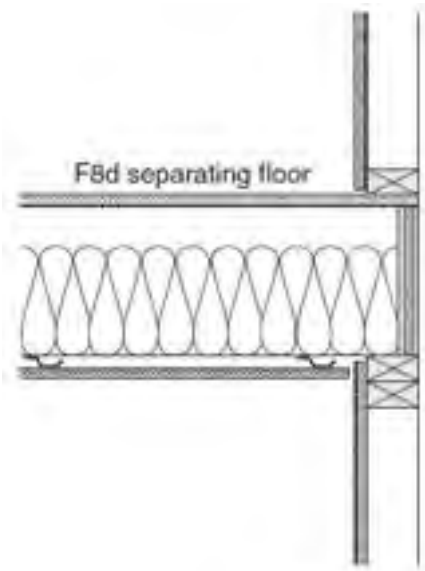
- (1) Resilient metal channels are formed from steel having a maximum thickness of 0.46 mm (25 gauge) with slits or holes in the single "leg" between the faces fastened to the framing and to the gypsum board (see Figure 4 in MMAH Supplementary Standard SB-3). ASTM C754, "Installation of Steel Framing Members to Receive Screw-Attached Gypsum Panel Products", describes the installation of resilient metal channels.
- (2) Sound absorptive material is porous (closed-cell foam was not tested) and includes fibre processed from rock, slag, glass or cellulose fibre with a maximum density of 32 kg/m³. See Notes (3) and (6) of Table 1 and Note (4) of Table 2 of MMAH Supplementary Standard SB-3, "Fire and Sound Resistance for Existing Buildings" for additional information.

Table A-9.11.1.4.C.
Options for the Design and Construction of Junctions and Flanking Surfaces Between Separating Floor/Ceiling Assemblies in Vertically Adjoining Spaces for Compliance with Clause 9.11.1.1.(1)(b)

Type of Separating Floor/Ceiling Assembly with $STC \geq 50$ from Table 2 of MMAH Supplementary Standard SB-3	Options for Design and Construction of Junctions and Flanking Surfaces ⁽¹⁾ to Address Vertical Sound Transmission Paths	
F1 (with or without gypsum board ceiling)	<p align="center">Junctions with Flanking Steel-Framed Walls</p> <ul style="list-style-type: none"> • floor ends at flanking wall assembly (T-junction) or extends beyond it (cross-junction) • steel framing of flanking walls is loadbearing or non-loadbearing, with a single row of steel studs, staggered studs, or 2 rows of studs, with studs spaced not less than 406 mm o.c., with or without absorptive material⁽²⁾ in cavities • flanking wall structure is fastened to separating concrete floor but is not continuous across junction • gypsum board on flanking walls is not continuous across junction and is fastened directly to wall framing or on resilient metal channels⁽³⁾ 	<p align="center">Junctions with Flanking Concrete Walls</p> <ul style="list-style-type: none"> • floor ends at flanking wall assembly (T-junction) or extends beyond it (cross-junction) • one wythe of concrete blocks with mass per area not less than 200 kg/m² (e.g. normal-weight hollow core concrete block units⁽⁴⁾) • loadbearing (solid) or non-loadbearing (resilient) junction between top of flanking concrete block wall and floor structure • gypsum board lining is supported on wood or steel framing providing a cavity not less than 50 mm deep, with or without absorptive material⁽²⁾ in cavities • gypsum board on flanking walls is not continuous across junction and is fastened directly to wall framing or on resilient metal channels⁽³⁾
	<p align="center">Examples Showing Side View of Junctions</p>	

Table A-9.11.1.4.C. (Cont'd)
Options for the Design and Construction of Junctions and Flanking Surfaces Between Separating Floor/Ceiling Assemblies in Vertically Adjoining Spaces for Compliance with Clause 9.11.1.1.(1)(b)

Type of Separating Floor/Ceiling Assembly with $STC \geq 50$ from Table 2 of MMAH Supplementary Standard SB-3	Options for Design and Construction of Junctions and Flanking Surfaces ⁽¹⁾ to Address Vertical Sound Transmission Paths	
F8 to F38	Junctions with Flanking Loadbearing or Non-Loadbearing Walls	
	<ul style="list-style-type: none"> • wood studs of flanking wall are 38 mm x 89 mm or 38 mm x 140 mm and spaced 400 mm or 600 mm o.c. • flanking wall framing consists of single row of wood studs, staggered studs on a single 38 mm x 140 mm plate, or 2 rows of 38 mm x 89 mm wood studs on separate 38 mm x 89 mm plates, with or without absorptive material⁽²⁾ in wall cavities • gypsum board on flanking walls ends or is cut near floor framing and is fastened directly to wall framing or supported on resilient metal channels⁽³⁾ 	
	Example Showing Side View of Junctions in Flanking Loadbearing Wall	Example Showing Side View of Junctions in Flanking Non-Loadbearing Wall



Notes to Table A-9.11.1.4.C.:

- (1) See also Table A-9.11.1.4.D.
- (2) Sound absorptive material is porous (closed-cell foam was not tested) and includes fibre processed from rock, slag, glass or cellulose fibre with a maximum density of 32 kg/m³. See Notes (3) and (6) of Table 1 and Note (4) of Table 2 of MMAH Supplementary Standard SB-3, "Fire and Sound Resistance of Building Assemblies" for additional information.
- (3) Resilient metal channels are formed from steel having a maximum thickness of 0.46 mm (25 gauge) with slits or holes in the single "leg" between the faces fastened to the framing and to the gypsum board (see Figure 4 in MMAH Supplementary Standard SB-3). ASTM C754, "Installation of Steel Framing Members to Receive Screw-Attached Gypsum Panel Products", describes the installation of resilient metal channels.
- (4) Normal-weight concrete block units conforming to CSA A165.1, "Concrete Block Masonry Units", have aggregate with a density not less than 2 000 kg/m³; 190 mm hollow core units are 53% solid, providing a wall mass per area over 200 kg/m²; 140 mm hollow core units are 75% solid, providing a wall mass per area over 200 kg/m².

Table A-9.11.1.4.D.
Options for the Construction of a Separating Floor System to Further Improve
the Sound Insulation Performance Achieved with the Options in Table A-9.11.1.4.C.

Type of Separating Floor Assembly with $STC \geq 50$ from Table 2 of MMAH Supplementary Standard SB-3	Performance Improvement Options for Junctions Between Separating Floors and Flanking Wall Assemblies
F1 (with or without gypsum board ceiling)	<ul style="list-style-type: none"> • Add heavier additional material layer over subfloor and/or resilient layer under additional material layer or between additional material layer and finished flooring • Add gypsum board ceiling supported at least 100 mm below concrete floor with minimal structural connection (e.g. ceiling framing supported resiliently) and sound absorptive material⁽¹⁾ in cavity • Support gypsum board of flanking walls of lower room on resilient metal channels⁽²⁾ (if framed with loadbearing studs)
F8 to F38	<ul style="list-style-type: none"> • Add heavier additional material layer over subfloor and/or resilient layer under additional material layer or between additional material layer and finished flooring • Add more/heavier gypsum board to ceiling and increase spacing of resilient metal channels⁽²⁾ to 600 mm o.c. • Support gypsum board of flanking loadbearing walls of lower room on resilient metal channels⁽²⁾ • Support gypsum board on flanking non-loadbearing walls of lower room on resilient metal channels⁽²⁾

Notes to Table A-9.11.1.4.D.:

- (1) Sound absorptive material is porous (closed-cell foam was not tested) and includes fibre processed from rock, slag, glass or cellulose fibre with a maximum density of 32 kg/m³. See Notes (3) and (6) of Table 1 and Note (4) of Table 2 of MMAH Supplementary Standard SB-3, "Fire and Sound Resistance of Building Assemblies" for additional information.
- (2) Resilient metal channels are formed from steel having a maximum thickness of 0.46 mm (25 gauge) with slits or holes in the single "leg" between the faces fastened to the framing and to the gypsum board (see Figure 4 in MMAH Supplementary Standard SB-3). ASTM C754, "Installation of Steel Framing Members to Receive Screw-Attached Gypsum Panel Products", describes the installation of resilient metal channels.

a10.1 A-Table 9.11.1.4. Floor Treatments.

The sound insulation performance of lightweight framed floors can be improved by adding floor treatments, i.e., additional layers of material over the subfloor (e.g. concrete topping, OSB or plywood) and finished flooring or coverings (e.g., carpet, engineered wood). Table A-Table 9.11.1.4. presents the mass per area values based on thickness and density of a number of generic floor treatment materials (the values for proprietary products may be different; consult the manufacturer's current data sheets for their products' values).

Table A-Table 9.11.1.4.
Mass per Area of Floor Treatment Materials

Floor Treatment Material	Thickness, mm	Density, kg/m ³	Mass per Area, kg/m ²
Materials Typically Having a Mass per Area Less than 8 kg/m ²			
Medium-density fibreboard (MDF)	2.9 – 6.1	790 – 810	2.3 – 5.0
Plywood – generic softwood	12.5 – 13.3	450 – 500	5.6 – 6.6
	15.5 – 16.3		7.0 – 8.1
Ceramic tile	8.4	700 – 1 000	5.9 – 8.4
Materials Typically Having a Mass per Area Greater than 8 kg/m ² but Less than 16 kg/m ²			
Particleboard	11.3 – 19.2	710 – 755	8.1 – 14.5
Medium-density fibreboard (MDF)	13.9 – 21.1	640 – 755	8.9 – 15.9
Oriented strandboard (OSB)	14.3 – 15.8	600 – 680	8.6 – 10.7
	17.3 – 18.8		10.4 – 12.8
Plywood – generic softwood	25.5	450 – 500	11.5 – 13.1
Materials Typically Having a Mass per Area Greater than 16 kg/m ² but Less than 32 kg/m ²			
Medium-density fibreboard (MDF)	25.0 – 32.1	640 – 740	16.0 – 23.7
Materials Typically Having a Mass per Area Greater than 32 kg/m ²			
Concrete	40.0 – 50.0	2 015 – 2 380	80.6 – 119.0
Gypsum concrete	25.0	1 840 – 1 870	46.1 – 46.7
Column 1	2	3	4

A-Table 9.12.2.2. Minimum Depths of Foundations.

The requirements for clay soils or soils not clearly defined are intended to apply to those soils that are subject to significant volume changes with changes in moisture content.

A-9.12.2.2.(2) Depth and Insulation of Foundations.

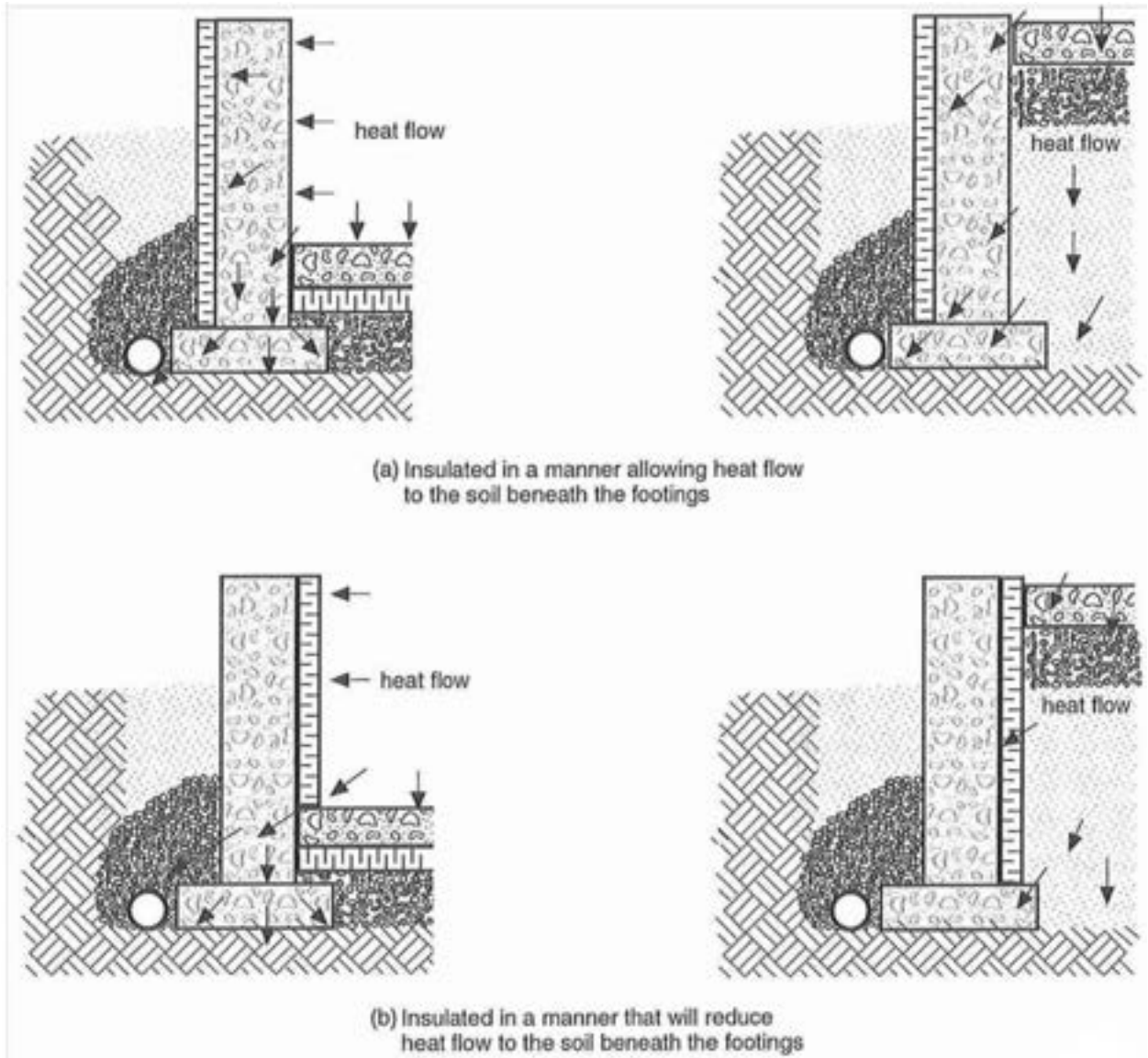


Figure A-9.12.2.2(2)
Foundation Insulation and Heat Flow to Footings

A-9.12.3.3.(1) Deleterious Material in Backfill.

The deleterious debris referred to in this provision includes, but is not limited to:

- organic material and other material subject to decomposition and compaction, which could have an adverse effect on grading around the building,
- materials that will off-gas and have the potential to pose a health hazard, and
- materials that are incompatible with materials used in the foundations, footings, drainage materials or components, or other elements of the building whose required performance would be adversely affected.

e7 A-9.13.2.5. Protection of Interior Finishes from Moisture.

Excess water from cast-in-place concrete and ground moisture tends to migrate toward interior spaces, particularly in the spring and summer. Where moisture-susceptible materials, such as finishes or wood members, are in contact with the foundation wall, the moisture needs to be controlled by installing a moisture barrier on the interior surface of the foundation wall that extends from the underside of the interior finish up the face of the wall to a point just above the level of the ground outside.

The reason the moisture barrier on the interior surface of the foundation wall must be terminated near ground level is to allow any moisture that finds its way into the finished wall cavity from the interior space (through leaks in the air or vapour barrier) to diffuse to the exterior. If the vapour permeance of dampproofing membranes or coatings exceeds $170 \text{ ng}/(\text{Pa}\cdot\text{s}\cdot\text{m}^2)$, such moisture barriers may be carried full height; if their vapour permeance is less than that, this moisture risks being trapped on the interior surface of the moisture barriers. The permeance limit corresponds to the lower limit for breather-type membranes, such as asphalt-impregnated sheathing paper.

Some insulation products can also be used to protect interior finishes from the effects of moisture. They have shown acceptable performance when applied over the entire foundation wall because, in this case, they also provide vapour barrier and moisture barrier functions and possibly also the air barrier function. Where a single product provides all these functions, there is no risk of trapping moisture between two functional barriers with low water vapour permeance.

e7 A-9.13.2.6.(1) Polyethylene Under Slabs-on-Ground.

Finishing a concrete slab placed directly on polyethylene can, in many cases, cause problems for the inexperienced finisher. A rule of finishing, whether concrete is placed on polyethylene or not, is to never finish or “work” the surface of the slab while bleed water is present or before all the bleed water has risen to the surface and evaporated. If finishing operations are performed too early, such as before all the bleed water has risen and evaporated, surface defects such as blisters, crazing, scaling and dusting can result. This is often the case with slabs placed directly on polyethylene. The amount of bleed water that may come to the surface and the time required for this to happen is increased from that of a slab placed on a compacted granular base. The excess water in the mix from the bottom portion of the slab cannot bleed downward and out of the slab and be absorbed into the granular material below, because of the polyethylene. Therefore, all bleed water, including that from the bottom of the slab, must now rise through the slab to the surface. Quite often in such cases, finishing operations are begun too soon and surface defects result.

One solution that is often suggested is to place a layer of sand between the polyethylene and the concrete. However, this is not an acceptable solution for the following reason: it is unlikely that the polyethylene will survive the slab pouring process entirely intact. Nevertheless, the polyethylene will still be effective in retarding the flow of soil gas if it is in intimate contact with the concrete; soil gas will only be able to penetrate where a break in the polyethylene coincides with a crack in the concrete. The majority of concrete cracks will probably be underlain by intact polyethylene. On the other hand, if there is an intervening layer of a porous medium, such as sand, soil gas will be able to travel laterally from a break in the polyethylene to the nearest crack in the concrete and the total system will be much less resistant to soil gas penetration.

To reduce and/or control the cracking of concrete slabs, it is necessary to understand the nature and causes of volume changes of concrete and in particular those relating to drying shrinkage. The total amount of water in a mix is by far the largest contributor to the amount of drying shrinkage and resulting potential cracking that may be expected from a given concrete. The less total amount of water in the mix, the less volume change (due to evaporation of water), which means the less drying shrinkage that will occur. To lessen the volume change and potential cracking due to drying shrinkage, a mix with the lowest total amount of water that is practicable should always be used. To lower the water content of a mix, superplasticizers are often used to provide the needed workability of the concrete during the placing operation. High water/cementing materials

ratio concretes usually have high water content mixes. They should be avoided to minimize drying shrinkage and cracking of the slab. The water/cementing materials ratio for slabs-on-ground should be no higher than 0.55.

A-9.13.4. Exclusion of Soil Gas.

Outdoor air entering a dwelling through above-grade leaks in the building envelope normally improves the indoor air quality in the dwelling by reducing the concentrations of pollutants and water vapour. It is only undesirable because it cannot be controlled. On the other hand, air entering a dwelling through below-grade leaks in the envelope may increase the water vapour content of the indoor air and may also bring in a number of pollutants which it picks up from the soil. This mixture of air, water vapour and pollutants is sometimes referred to as “soil gas”. One pollutant often found in soil gas is radon.

Radon is a colourless, odourless, radioactive gas that occurs naturally as a result of the decay of radium. It is found to varying degrees as a component of soil gas in all regions of Canada and is known to enter dwelling units by infiltration into basements and crawl spaces. The presence of the decay products of radon in sufficient quantity can lead to increased risk of lung cancer.

The potential for high levels of radon infiltration is very difficult to evaluate prior to construction and thus a radon problem may only become apparent once the building is completed and occupied. MMAH Supplementary Standard SB-9 requires the application of certain radon exclusion measures in dwellings where methane or radon gasses are known to be a problem.

The principal method of resisting the ingress of all soil gases, a resistance which is required for all buildings (see Sentence 9.13.4.2.(1)), is to seal the interface between the soil and the occupied space, so far as is reasonably practicable. Sections 9.18. and 9.25. contain requirements for air and soil gas barriers in assemblies in contact with ground, including those in crawl spaces. Providing control joints to reduce cracking of foundation walls and airtight covers for sump pits (see Section 9.14.) are other measures that can help achieve this objective. The requirements provided in Subsection 9.25.3. are explained in Appendix Notes A-9.25.3.4. and 9.25.3.6. and A-9.25.3.6.(2) and (3).

The principal method of excluding radon is to ensure that the pressure difference across the ground space interface is positive (i.e., towards the outside) so that the inward flow of radon through any remaining leaks will be minimized. The requirements provided in Article 9.13.4.3. are explained in Appendix Note A-9.13.4.3.

A-9.14.2.1.(2) Insulation Applied to the Exterior of Foundation Walls.

In addition to the prevention of heat loss, some types of mineral fibre insulation, such as rigid glass fibre, are installed on the exterior of basement walls for the purpose of moisture control. This is sometimes used instead of crushed rock as a drainage layer between the basement wall and the surrounding soil in order to facilitate the drainage of soil moisture. Water drained by this drainage layer must be carried away from the foundation by the footing drains or the granular drainage layer in order to prevent it from developing hydro-static pressure against the wall. Provision must be made to permit the drainage of this water either by extending the insulation or crushed rock to the drain or by the installation of granular material connecting the two. The installation of such drainage layer does not eliminate the need for normal waterproofing or dampproofing of walls as specified in Section 9.13.

A-9.15.1.1. Application of Footing and Foundation Requirements to Decks and Similar Structures.

Decks, balconies, verandas and similar platforms that are attached to a building or that have an area greater than 10 m² are, by definition, considered as buildings or parts of buildings. Consequently, they are subject to the requirements in Section 9.15.

A-9.15.1.1.(1)(c) and A-9.20.1.1.(1)(b) Flat Insulating Concrete Form Walls.

Insulating concrete form (ICF) walls are concrete walls that are cast into polystyrene forms, which remain in place after the concrete has cured. Flat ICF walls are solid ICF walls where the concrete is of uniform thickness over the height and width of the wall.

A-9.15.2.4.(1) Preserved Wood Foundations - Design Assumptions.

Tabular data and figures in CAN/CSA-S406, “Construction of Preserved Wood Foundations” are based upon the general principles provided in CAN/CSA-O86.1, “Engineering Design in Wood” with the following assumptions:

- soil bearing capacity: 75 kPa or more,
- clear spans for floors: 5 m or less,
- floor loadings: 1.9 kPa for first floor and suspended floor, and 1.4 kPa for second storey floor,
- foundation wall heights: 2.4 for slab floor foundation, 3.0 m for suspended wood floor foundation,
- top of granular layer to top of suspended wood floor: 600 mm,
- lateral load from soil pressure: equivalent to fluid pressure of 4.7 kPa per metre of depth,
- ground snow load: 3 kPa,
- basic snow load coefficient: 0.6,
- roof loads are carried to the exterior wall,
- dead loads:

roof	0.50 kPa
floor	0.47 kPa
wall (with siding)	0.32 kPa
wall (with masonry veneer)	1.94 kPa
foundation wall	0.27 kPa
partitions	0.20 kPa

A-9.15.3.4.(2) Footing Sizes.

The footing sizes in Table 9.15.3.4. are based on typical construction consisting of a roof, not more than 3 storeys, and centre bearing walls or beams. For this reason, Clause 9.15.3.3.(1)(b) stipulates a maximum supported joist span of 4.9 m.

It has become common to use flat wood trusses or wood I-joists to span greater distances in floors of small buildings. Where these spans exceed 4.9 m, minimum footing sizes may be based on the following method:

- (a) Determine for each storey the span of joists that will be supported on a given footing. Sum these lengths (sum_1).
- (b) Determine the product of the number of storeys times 4.9 m (sum_2).
- (c) Determine the ratio of sum_1 , to sum_2 .
- (d) Multiply this ratio by the minimum footing sizes in Table 9.15.3.4. to get the required minimum footing size.

Example: A 2-storey house is built using wood I-joists spanning 6 m.

- (a) $sum_1 = 6 + 6 = 12$ m
- (b) $sum_2 = 4.9 \times 2 = 9.8$ m
- (c) ratio $sum_1/sum_2 = 12/9.8 = 1.22$
- (d) required minimum footing size = 1.22×350 mm (minimum footing size provided in Table 9.15.3.4.) = 427 mm.

A-9.16.4.3.(1) Thickness.

Depressions and ridges often develop at the soil surface or granular base from construction activity prior to the placement of a concrete slab. Allowances for such irregularities in the base must be recognized. A maximum tolerance of -10 mm is permitted provided the minimum slab thickness at any point is not less than 65 mm and the mean thickness of the concrete slab (exclusive of topping) is 75 mm, as shown in Figure A-9.16.4.3.(1).

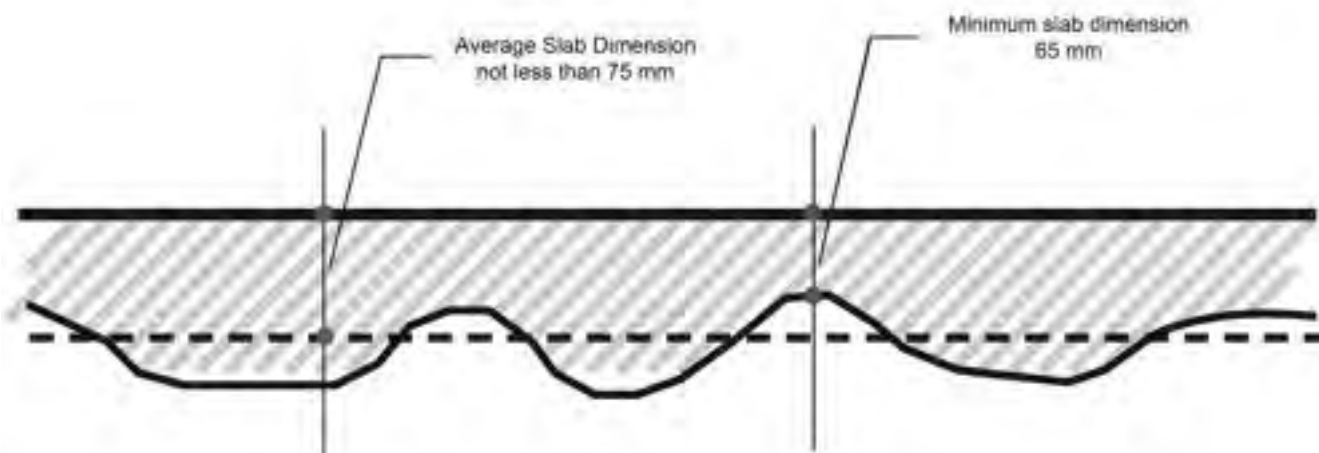


Figure A-9.16.4.3(1)
Mean Thickness of Concrete Slabs

A-9.17.2.2.(2) Lateral Support of Columns.

Because the Building Code does not provide prescriptive criteria to describe the minimum required lateral support, structures are limited to those that have demonstrated effective performance over time and those that are designed according to Part 4. Verandas on early 20th century homes provide one example of structures whose floor and roof are typically tied to the rest of the building to provide effective lateral support. Large decks set on tall columns, however, are likely to require additional lateral support even where they are connected to the building on one side.

A-9.17.3.4. Design of Steel Columns.

The permitted live floor loads of 2.4 kPa and the spans described for steel beams, wood beams and floor joists are such that the load on columns could exceed 36 kN, the maximum allowable load on columns prescribed in CAN/CGSB-7.2, “Adjustable Steel Columns”. In the context of Part 9, loads on columns are calculated from the supported area times the live load per unit area, using the supported length of joists and beams. The supported length is half of the joist spans on each side of the beam and half the beam span on each side of the column.

Dead load is not included based on the assumption that the maximum live load will not be applied over the whole floor. Designs according to Part 4 must consider all applied loads.

A-9.18.7.1.(3) Protection of Ground Cover in Warm Air Plenums.

The purpose of the requirement is to protect combustible ground cover from smoldering cigarette butts that may drop through air registers. The protective material should extend beyond the opening of the register and have up-turned edges, as a butt may be deflected sideways as it falls.

A-9.19.1.1.(1) Venting of Attic and Roof Spaces.

Controlling the flow of moisture by air leakage and vapour diffusion into roof and attic spaces is necessary to limit moisture-induced deterioration. Given that imperfections normally exist in the vapour barriers and air barrier systems, recent research indicates that venting of roof and attic spaces is generally still required. The exception provided in Article 9.19.1.1. recognizes that some specialized ceiling-roof assemblies, such as those used in some factory-built buildings, have, over time, demonstrated that their construction is sufficiently tight to prevent excessive moisture accumulation. In these cases, ventilation would not be required.

A-9.19.2.1.(2) Attic Access Openings.

The dimensions for attic access as provided for in the Building Code are minimum dimensions. Where a fuel fired appliance is to be located in the attic, a larger attic access opening shall be provided in conformance with the Gas Utilization Code or other applicable installation code.

A-9.20.1.2. Seismic Zones.

Information on seismic zones for various localities can be found in MMAH Supplementary Standard SB-1.

A-9.20.5.1.(1) Masonry Support.

Masonry veneer must be supported on a stable structure in order to avoid cracking of the masonry due to differential movement relative to parts of the support. Wood framing is not normally used as a support for the weight of masonry veneer because of its shrinkage characteristics. Where the weight of masonry veneer is supported on a wood structure, as is the case for the preserved wood foundations referred to in Sentence 9.20.5.1.(1) for example, measures must be taken to ensure that any differential movement that may be harmful to the performance of masonry is minimized or accommodated. The general principle stated in Article 9.4.1.1., however, makes it possible to support the weight of masonry veneer on wood framing, provided that engineering design principles prescribed in Part 4 are followed to ensure that the rigidity of the support is compatible with the stiffness of the masonry being supported and that differential movements between the support and masonry are accommodated.

A-Table 9.20.5.2.C. Steel Beams Supporting Masonry Veneer.

Design Assumptions

1. Density of Veneer:
 - Brick = 18.9 kN/m³
 - Limestone or Sandstone = 22.62 kN/m³
2. Dead Load of Veneer:
 - 70 mm Brick = 0.070 x 18.9 = 1.32 kPa
 - 89 mm Brick = 0.089 x 18.9 = 1.68 kPa
 - 100 mm Stone = 0.10 x 22.62 = 2.26 kPa
3. Design Standards:
 - CSA S304.1-94, "Masonry Design for Buildings (Limit States Design)"
 - CSA S16.1-94, "Limit States Design of Steel Structures"
4. Design Assumptions - Steel Angles in Table 9.20.5.2.B.:
 - For angle sizes (150 x 90 x 10; 150 x 90 x 13; 150 x 100 x 13; 180 x 100 x 10; 180 x 100 x 13)
 - Mid-span deflection limited to span/700 as per Note (6) of Table 9.20.5.2.A. in the Building Code.
 - Arch action of the brick veneer is assumed, which means that all brick weight within a 45 degree angle of the edge of the opening is not considered in the design of the lintel.
 - The steel yield strength is 300 MPa.
5. Design Assumptions - Steel Wide Flange Beams in Table 9.20.5.2.C.:
 - Mid-span deflection limited to span/700 as per Note (6) of Table 9.20.5.2.A in the Building Code for the brick load only.
 - Mid-span deflection limited to span/600 as per Clause 6.3.5.1 of CSA S304.1 for brick weight plus roof live load (see below).
 - Arch action of the brick veneer is assumed, which means that all brick weight within a 45 degree angle of the edge of the opening is not considered in the design of the lintel.
 - The beam is designed for a roof live load of 2.3 kN/m. This is to account for the fact that the steel beam will typically support a wood stud wall and a gable truss or outlook rafters as well as the brick veneer.
 - The beam is considered to be laterally unsupported along its length since it does not support a floor.
 - The beam is supported by steel columns at each end.
 - The steel yield strength is 300 MPa.

a10.1 A-9.20.8.5.(1) Distance from Edge of Masonry to Edge of Supporting Members.

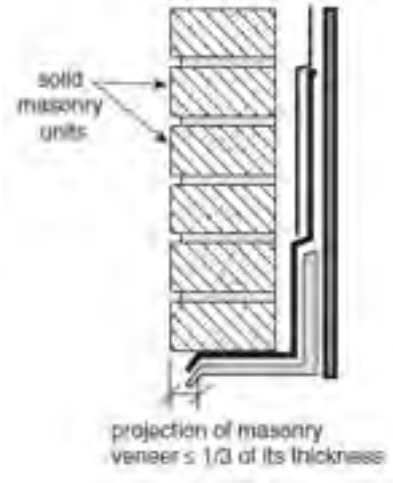


Figure A-9.20.8.5.(1)
Maximum Projection of Masonry Veneer Beyond its Support

A-9.20.12.2.(2) Corbelling of Masonry Foundation Walls.

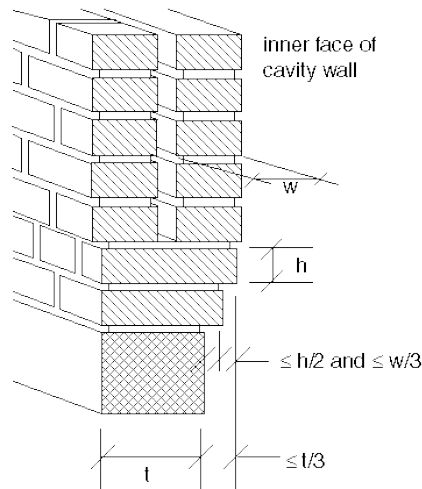


Figure A-9.20.12.2.(2)
Maximum Corbel Dimensions

A-9.20.13.9.(3) Dampproofing of Masonry Walls.

The reason for installing sheathing paper behind masonry walls is to prevent rainwater from reaching the interior finish if it should leak past the masonry. The sheathing paper intercepts the rainwater and leads it to the bottom of the wall where the flashing directs it to the exterior via weep holes. If the insulation is a type that effectively resists the penetration of water, and is installed so that water will not collect behind it, then there is no need for sheathing paper. If water that runs down between the masonry and the insulation is able to leak out at the joints in the insulation, such insulation will not act as a substitute for sheathing paper. If water cannot leak through the joints in the insulation but collects in cavities between the masonry and insulation, subsequent freezing could damage the wall. Where sheathing paper is not used, therefore, the adhesive or mortar should be applied to form a continuous bond between the masonry and the insulation. If this is not practicable because of an irregular masonry surface, then sheathing paper is necessary.

A-9.21.1.2.(1) Factory-Built Chimneys.

Certain solid-fuel burning appliances may be connected to factory-built chimneys other than those specified in Sentence 9.21.1.2.(1) if tests show that the use of such a chimney will provide an equivalent level of safety, as an alternative solution pursuant to Section 2.1. of Division C.

A-9.21.3.6.(2) Metal Chimney Liners.

Masonry chimneys with metal liners may be permitted to serve solid-fuel burning appliances if tests show that such liners will provide an equivalent level of safety, as an alternative solution pursuant to Section 2.1. of Division C.

A-9.21.4.4.(1) Location of Chimney Top.

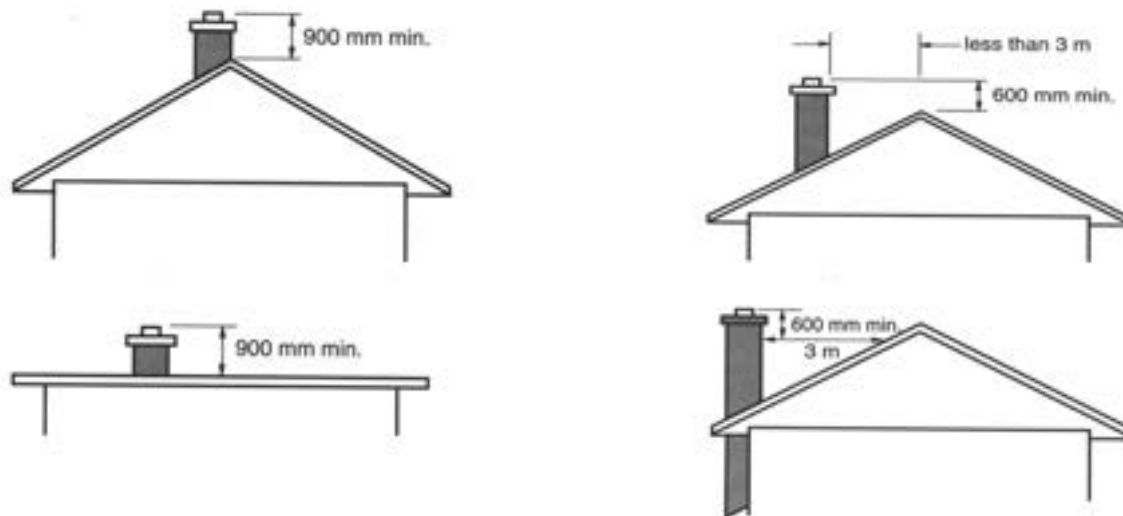


Figure A-9.21.4.4.(1)
Vertical and Horizontal Distance from Chimney Top to Roof

A-9.21.4.5.(2) Lateral Support for Chimneys.

Where a chimney is fastened to the house framing with metal anchors, in accordance with CAN/CSA-A370, “Connectors for Masonry”, it is considered to have adequate lateral support. The portion of the chimney stack above the roof is considered as free standing and may require additional lateral support.

A-9.21.5.1.(1) Clearance from Combustible Materials.

For purposes of this Sentence, an exterior chimney can be considered to be one which has at least one surface exposed to the outside atmosphere or unheated space over the majority of its height. All other chimneys should be considered to be interior.

A-9.23.1.1. Structural Framing Systems Other than Light Wood-Frame Construction.

The prescriptive requirements in Section 9.23. apply only to standard light wood-frame construction. Other structural framing systems, such as post, beam and plank construction, plank frame wall construction, and log construction must be designed in accordance with Part 4.

A-9.23.1.1.(1) Application of Section 9.23.

In previous editions of the Code, Sentence 9.23.1.1.(1) referred to “conventional” wood-frame construction. Over time, conventions have changed and the application of Part 9 has expanded.

The prescriptive requirements provided in Section 9.23. still focus on lumber beams, joists, studs and rafters as the main structural elements of “wood-frame construction”. The requirements recognize - and have recognized for some time - that walls and floors may be supported by components made of material other than lumber; for example, by foundations described in Section 9.15. or by steel beams described in Article 9.23.4.3. These components still fall within the general category of wood-frame construction.

With more recent innovations, alternative structural components are being incorporated into wood-frame buildings. Wood I-joists, for example, are very common. Where these components are used in lieu of lumber, the requirements in Section 9.23. that specifically apply to lumber joists do not apply to these components: for example, limits on spans and acceptable locations for notches and holes. However, requirements regarding the fastening of floor sheathing to floor joists still apply, and the use of wood I-joists does not affect the requirements for wall or roof framing.

Similarly, if steel floor joists are used in lieu of lumber joists, the requirements regarding wall or roof framing are not affected.

Conversely, Sentence 9.23.1.1.(1) precludes the installation of pre-cast concrete floors on wood-frame walls since these are not “generally comprised of ... small repetitive structural members ... spaced not more than 610 mm o.c.”

Thus, the reference to “engineered components” in Sentence 9.23.1.1.(1) is intended to indicate that, where an engineered product is used in lieu of lumber for one part of the building, this does not preclude the application of the remainder of Section 9.23. to the structure, provided the limits to application with respect to cladding, sheathing or bracing, spacing of framing members, supported loads and maximum spans are respected.

e7 A-9.23.3.1.(3) Standard for Screws.

The requirement that wood screws conform to ANSI/ASME B18.6.1., “Wood Screws (Inch Series)” is not intended to preclude the use of Robertson head screws. The requirement is intended to specify the mechanical properties of the fastener, not to restrict the means of driving the fastener.

A-9.23.3.3.(1) Prevention of Splitting.

The intent of the phrase “staggering the nails in the direction of the grain” is illustrated in Figure A-9.23.3.3.(1).

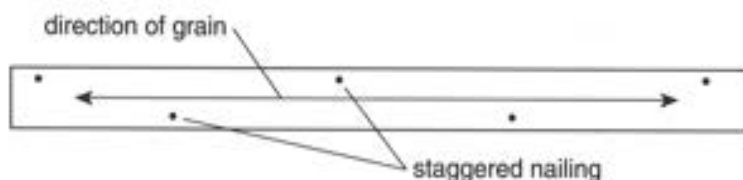


Figure A-9.23.3.3.(1)
Staggered Nailing

A-9.23.4.2. Span Tables for Wood Joists, Rafters and Beams.

In these span tables the term “rafter” refers to a sloping wood framing member which supports the roof sheathing and encloses an attic space but does not support a ceiling. The term “roof joist” refers to a horizontal or sloping wood framing member that supports the roof sheathing and the ceiling finish but does not enclose an attic space. Where rafters or roof joists are intended for use in a locality having a higher specified roof snow load than shown in the tables, the maximum member spacing may be calculated as the product of the member spacing and specified snow load shown in the span tables divided by the specified snow load for the locality being considered. The following examples show how this principle can be applied:

- (a) For a 3.5 kPa specified snow load, use spans for 2.5 kPa and 610 mm o.c. spacing but space members 406 mm o.c.
- (b) For a 4.0 kPa specified snow load, use spans for 2.0 kPa and 610 mm o.c. spacing but space members 305 mm o.c.

The maximum spans in the span tables are measured from the inside face or edge of support to the inside face or edge of support.

In the case of sloping roof framing members, the spans are expressed in terms of the horizontal distance between supports rather than the length of the sloping member. The snow loads are also expressed in terms of the horizontal projection of the sloping roof. Spans for odd size lumber may be estimated by straight line interpolation in the tables.

These span tables may be used where members support a uniform live load only. Where the members are required to be designed to support a concentrated load, they must be designed in conformance with Subsection 4.3.1.

Supported joist length in Tables A-8, A-9 and A-10 means half the sum of the joist spans on both sides of the beam. For supported joist lengths between those shown in the tables, straight line interpolation may be used in determining the maximum beam span.

Tables A-1 to A-16 cover only the most common configurations. Especially in the area of floors, a wide variety of other configurations is possible: glued subfloors, concrete toppings, machine stress rated lumber, etc. The Canadian Wood Council publishes “The Span Book”, a compilation of span tables covering many of these alternative configurations. Although these tables have not been subject to the formal committee review process, the Canadian Wood Council generates, these span tables for wood structural components; thus Building Code users can be confident that the alternative span tables in “The Span Book” are consistent with the span tables in the Building Code and with relevant Building Code requirements.

Spans for wood joists, rafters and beams which fall outside the scope of these tables, including those for U.S. species and individual species not marketed in the commercial species combinations described in the span tables, can be calculated in conformance with CSA O86.1, “Engineering Design in Wood”.

A-9.23.4.2.(2) Numerical Method to Establish Vibration-Controlled Spans for Wood Frame Floors.

In addition to the normal strength and deflection analyses, the calculations on which the floor joist span tables are based include a method of ensuring that the spans are not so long that floor vibrations could lead to occupants perceiving the floors as too “bouncy” or “springy”. Limiting deflection under the normal uniformly distributed loads to 1/360 of the span does not provide this assurance. Normally, vibration analysis requires detailed dynamic modelling. However, the calculations for the span tables use the following simplified static analysis method of estimating vibration-acceptable spans:

- The span which will result in a 2 mm deflection of a single joist supporting a 1 kN concentrated midpoint load is calculated.
- This span is multiplied by a factor, K, to determine the “vibration-controlled” span for the entire floor system. If this span is less than the strength- or deflection-controlled span under uniformly distributed load, the vibration-controlled span becomes the maximum span.
- The K factor is determined from the following relationship:

$$\ln(K) = A - B \cdot \ln(S_i/S_{184}) + G$$

where

A, B = constants, the values of which are determined from Tables A-9.23.4.2.(2)A. or B.

G = constant, the value of which is determined from Table A-9.23.4.2.(2)C.

S_i = span which results in a 2 mm deflection of the joist in question under a 1 kN concentrated midpoint load

S_{184} = span which results in a 2 mm deflection of a 38 x 184 mm joist of same species and grade as the joist in question under a 1 kN concentrated midpoint load.

For a given joist species and grade, the value of K shall not be greater than K_3 , the value which results in a vibration-controlled span of exactly 3 m. This means that for vibration-controlled spans 3 m or less, K always equals K_3 , and for vibration-controlled spans greater than 3 m, K is as calculated.

Note that, for a sawn lumber joist, the ratio S_i/S_{184} is equivalent to its depth (mm) divided by 184.

Due to rounding differences, the method, as presented here, might produce results slightly different from those produced by the computer program used to generate the span tables.

Additional background information on this method can be found in the following publications:

- Onysko, D.M. Serviceability Criteria for Residential Floors Based on a Field Study of Consumer Response. Project 03-50-10-008. Forintek Canada Corp., Ottawa, Canada 1985.
- Onysko, D.M. Performance Criteria for Residential Floors Based on Consumer Responses. 1988 International Conference on Timber Engineering, Seattle, September 19-22, Forest Products Research Society, Vol.1, 1988, pp. 736-745.
- Onysko, D.M. Performance and Acceptability of Wood Floors - Forintek Studies. Proceedings of Symposium/Workshop on Serviceability of Buildings, Ottawa, May 16-18, National Research Council of Canada, Ottawa, 1988.

Table A-9.23.4.2.(2)A.
Constants A and B for Calculating Vibration-Controlled Floor Joist Spans - General Cases

Subfloor Thickness, mm	With Strapping ⁽¹⁾			With Bridging			With Strapping and Bridging		
	Joist Spacing, mm			Joist Spacing, mm			Joist Spacing, mm		
	305	406	610	305	406	610	305	406	610
Constant A									
15.5	0.30	0.25	0.20	0.37	0.31	0.25	0.42	0.35	0.28
19.0	0.36	0.30	0.24	0.45	0.37	0.30	0.50	0.42	0.33
Constant B									
	0.33			0.38			0.41		
Column 1	2	3	4	5	6	7	8	9	10

Notes to Table A-9.23.4.2.(2)A.:

(1) Gypsum board attached directly to joists can be considered equivalent to strapping.

Table A-9.23.4.2.(2)B.
Constants A and B for Calculating Vibration-Controlled Floor Joist Spans - Special Cases

Subfloor Thickness, mm	Joists with Ceiling Attached to Wood Furring ⁽¹⁾						Joists with Concrete Topping ⁽²⁾		
	Without Bridging			With Bridging			With or Without Bridging		
	Joist Spacing, mm			Joist Spacing, mm			Joist Spacing, mm		
	305	406	610	305	406	610	305	406	610
Constant A									
15.5	0.39	0.33	0.24	0.49	0.44	0.38	0.58	0.51	0.41
19.0	0.42	0.36	0.27	0.51	0.46	0.40	0.62	0.56	0.47
Constant B									
	0.34			0.37			0.35		
Column 1	2	3	4	5	6	7	8	9	10

Notes to Table A-9.23.4.2.(2)B.:

- (1) Wood furring means 19 x 89 mm boards not more than 610 mm o.c., or 19 x 64 mm boards not more than 305 mm o.c. For all other cases, see Table A-9.23.4.2.(2)A.
- (2) 30 mm to 51 mm normal weight concrete (not less than 20 MPa) placed directly on the subflooring.

Table A-9.23.4.2.(2)C.
Constant G for Calculating Vibration-Controlled Floor Joist Spans

Floor Description	Constant G
Floors with nailed ⁽¹⁾ subfloor	0.00
Floor with nailed and field-glued ⁽²⁾ subfloor, vibration-controlled span greater than 3 m	0.10
Floor with nailed and field-glued ⁽²⁾ subfloor, vibration-controlled span 3 m or less	0.15
Column 1	2

Notes to Table A-9.23.4.2.(2)C.:

- (1) Common wire nails, spiral nails or wood screws can be considered equivalent for this purpose.
- (2) Subfloor field-glued to floor joists with elastomeric adhesive complying with standard CAN/CGSB-71.26-M, "Adhesives for Field-Gluing Plywood to Lumber Framing for Floor Systems".

A-9.23.4.3.(1) Maximum Spans for Steel Beams Supporting Floors in Dwellings.

A beam may be considered to be laterally supported if wood joists bear on its top flange at intervals of 610 mm or less over its entire length, if all the load being applied to this beam is transmitted through the joists and if 19 mm by 38 mm wood strips in contact with the top flange are nailed on both sides of the beam to the bottom of the joists supported. Other additional methods of positive lateral support are acceptable.

For supported joist lengths intermediate between those in the table, straight line interpolation may be used in determining the maximum beam span.

Design Assumptions for Tables A-20 to A-29 (Steel Beams Supporting Roofs and Floors)

1. Density of Brick Veneer:
 - Brick = 18.9 kN/m³

2. Dead Load of Brick Veneer:
 - 89 mm Brick = $0.089 \times 18.9 = 1.68$ kPa
 - Brick loading on beam = 3 m high brick \times 1.68 = 5.04 kN/m. This is based on a single storey wall with windows and a brick gable above the top of the stud wall. In this case, the windows in the exterior wall nullify the arch action of the brick and the load is applied uniformly along the length of the beam.
3. Dead Load of Structure:
 - Roof = 0.62 kPa (Asphalt shingle roof)
 - Floor = 1.5 kPa as per Appendix Note A-Table 9.23.4.3.
4. Live Loads:
 - Floor = 1.9 kPa
 - Roof = as indicated in the Tables
5. Design Standards:
 - CSA S304.1-94, "Masonry Design for Buildings (Limit States Design)"
 - CSA S16.1-94, "Limit States Design of Steel Structures"
6. Design Assumptions:
 - Simply supported beam spans
 - Laterally supported top flange
 - Yield strength 300 MPa
 - Mid-span deflection limited to span/600 as per Clause 6.3.5.1 of CSA S304.1, for brick weight plus live load. The self-weight of structure is typically on the beam prior to the application of the brick so the deflection check need only include live and brick loads.
 - For siding walls the mid-span deflection is limited to span/360 on live load.

A-Table 9.23.4.3. Spans for Steel Beams.

The spans provided in Table 9.23.4.3. reflect a balance of engineering and acceptable proven performance. The spans have been calculated based on the following assumptions:

- Simply supported beam spans
- Laterally supported top flange
- Yield strength 350 MPa
- Deflection limit $L/360$
- Live load = 1.9 kPa
- Dead load 1.5 kPa.

The calculation used to establish the specified maximum beam spans also applies a revised live load reduction factor to account for the lower probability of a full live load being applied over the supported area in Part 9 buildings.

A-9.23.4.4. Concrete Topping.

Vibration- controlled spans given in Table A-2 for concrete topping are based on a partial composite action between the concrete, subflooring and joists. Normal weight concrete having a compressive strength of not less than 20 MPa, placed directly on the subflooring, provides extra stiffness and results in increased capacity. The use of a bond breaker between the topping and the subflooring, or the use of lightweight concrete topping limits the composite effects.

Where either a bond breaker or lightweight topping is used, Table A-1 may be used but the additional dead load imposed by the concrete must be considered. The addition of 51 mm of concrete topping can impose an added load of 0.8 to 1.2 kPa, depending on the density of the concrete.

Example:

- Assumptions:
- basic dead load = 0.5 kPa
 - topping dead load = 0.8 kPa
 - total dead load = 1.3 kPa
 - live load = 1.9 kPa
 - vibration limit: per A-9.23.4.2.(2)
 - deflection limit = $1/360$
 - ceiling attached directly to joists, no bridging

The spacing of joists in the span tables can be conservatively adjusted to allow for the increased load by using the spans in Table A-1 for 610 mm spacing, but spacing the joists 406 mm apart. Similarly, floor beam span tables can be adjusted by using 4.8 m supported length spans for cases where the supported length equals 3.6 m.

A-9.23.8.3. Joint Location in Built-Up Beams.

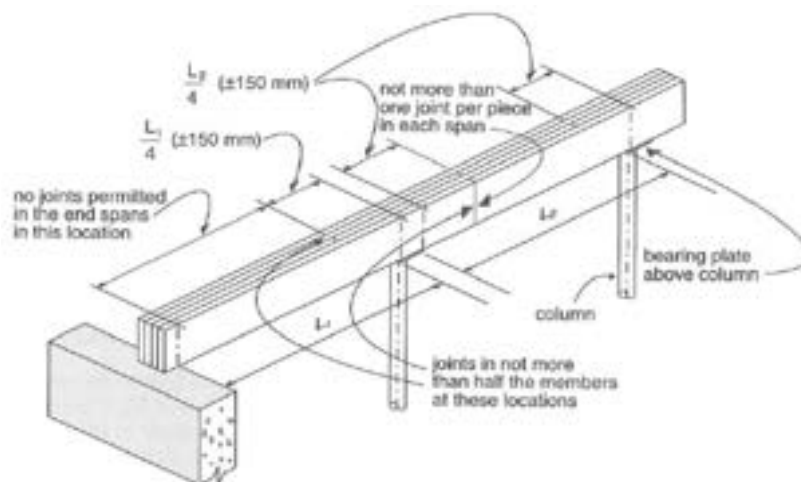


Figure A-9.23.8.3.
Joint Location in Built-up Beams

A-9.23.10.1.(2) Tall Stud Walls.

Design Assumptions for Tables A-30 to A-33.

1. Roof dead load is 0.5 kPa (asphalt shingle roof) as per rafter and lintel tables in the Building Code.
2. Specified roof snow load is the factored load incorporating rain load as per the rafter, header and lintel spans in the Building Code.
3. Wind loads are based on wind loads in the 2006 Building Code and the 2005 edition of the NBC as adopted in the *Engineering Guide for Wood Frame Construction* published by the Canadian Wood Council
 - a. Basic wind pressure is the 1 in 50 year pressure found in Table 1.2 of MMAH Supplementary Standard SB-1
 - b. $C_e = 0.7$ as per Sentence 4.1.7.1.(5)(b) in the Building Code
 - c. $C_p C_g = -2.1$ for ultimate limit state for wind acting alone
 - d. $C_p C_g = -1.75$ for the serviceability limit state
 - e. $C_p C_g = 1.5$ for wind acting in combination with gravity loads
 - f. C_{pi} varied from -0.45 to 0.3 as per *User's Guide - NBC 2005, Structural Commentaries (Part 4 of Division B)*.
Where external wind was a pressure (wind acting in combination with axial loads) the internal wind suction

coefficient of -0.45 was used. Where external wind was suction (wind acting alone) the internal wind pressure coefficient of 0.3 was used.

- g. $C_{gi} = 2.0$ as per Sentence 4.1.7.1.(6)(c) in the 2006 Building Code.
 - h. The importance factors used to calculate wind loads were 1.0 at the ultimate limit state and 0.75 at the serviceability limit state as per Table 4.1.7.1. in the 2006 Building Code.
4. Ultimate Limit State loads cases were in accordance with Table 4.1.3.2. in the 2006 Building Code.
 - a. 1.4 axial dead load
 - b. 1.25 axial dead load + 1.5 axial snow load
 - c. 1.25 axial dead load + 1.5 axial snow load + 0.4 lateral wind load
 - d. 1.25 axial dead load + 0.5 axial snow load + 1.4 lateral wind load
 - e. 1.4 lateral wind load
 5. Serviceability Limits States, based on the *Engineering Guide for Wood Frame Construction*, were calculated using specified lateral wind loads, and included:
 - a. Deflection limit of stud length/180 for walls with siding, and
 - b. Deflection limit of stud length/360 for walls with brick cladding.
 6. Stud resistance was calculated as per CSA O86 and adopted for the *Engineering Guide for Wood Frame Construction*
 - a. The system factors used were Case 2 load-sharing for bending moment resistance and Case 1 for compression resistance parallel to grain.
 - b. A load duration factor of 1.25 was used where lateral wind acted alone or in combination with axial loads.
 7. Fastening requirements are based on the short-term nail resistance values given in CSA O86-01.

A-9.23.10.2. Bracing.

Traditionally, diagonal bracing has been provided at the corners of wood framed walls to provide resistance against wind racking forces. Laboratory tests have indicated, however, that the bracing that had been traditionally used contributed relatively little to the overall strength of the wall. Most of the racking resistance was in effect provided by the interior finish. Because of this, the requirements for bracing were deleted in the late 1950's. (See "Shear Resistance of Wood Frame Walls", by A.T. Hansen, Building Practice Note 61, Institute for Research in Construction, National Research Council, Ottawa.)

Where the interior is not finished, however, bracing is necessary if the siding itself or the sheathing does not provide the required racking strength. If panel type siding is used, or if the sheathing consists of plywood, OSB, waferboard, gypsum board, diagonal lumber, or fibreboard sheathing, additional bracing is not considered necessary because of the wind bracing provided by these materials. Where bracing is provided, it must be installed at roughly a 45° angle on each wall and in each storey, extending the full height of the storey. This type of bracing provides considerably greater resistance to wind forces than the traditional bracing, which was found to be relatively ineffective. The permission to omit bracing assumes typical house designs. Some buildings may have reduced resistance to racking forces as a result of their configuration. These include tall narrow buildings in exposed locations with large door or window openings located in the short sides. In such cases, racking resistance can be improved by ensuring that paneled sections are placed adjacent to the openings. The Code does not address the issue of bracing of the structure during construction. It is often necessary to provide temporary bracing until the interior finish or sheathing is installed; however, this is not a Code requirement.

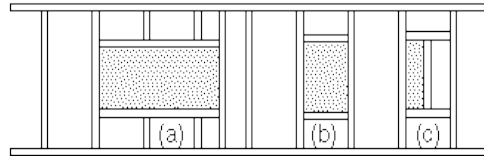
A-9.23.10.4.(1) Fingerjoined Lumber.

The NLGA "Standard Grading Rules for Canadian Lumber", referenced in Article 9.3.2.1. refers to two special product standards, SPS-1, "Fingerjoined Structural Lumber," and SPS-3, "Fingerjoined Stud Lumber - Vertical Use Only", produced by NLGA. Material identified as conforming to these standards is considered to meet the requirements in this Sentence for joining with a structural adhesive. Lumber fingerjoined in accordance with SPS-3 should be used as a vertical end-loaded member in compression only, where sustained bending or tension-loading conditions are not present, and where the moisture content of the wood will not exceed 19%. Fingerjoined lumber may not be visually regraded or remanufactured into a higher stress grade even if the quality of the lumber containing fingerjoints would otherwise warrant such regrading.

A-9.23.10.6.(2) Single Studs at Sides of Openings.

Configurations which comply

- (a) full height studs both sides
- (b) full height studs both sides and opening within stud space
- (c) opening within stud space



Configurations which do not comply

- (a) opening wider than stud space without full height studs both sides
- (b) opening narrower than but not within stud space

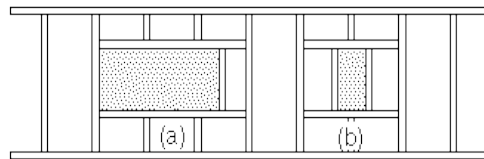
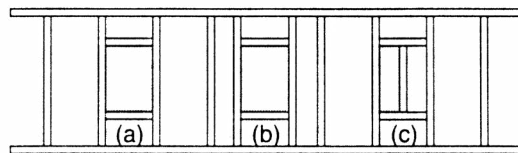


Figure A-9.23.10.6.(2)A.
Single Studs at Openings in Non-loadbearing Interior Walls

Configurations which comply

- (a), (b), (c) openings all narrower than and within stud space:
no two full stud space width openings in adjacent stud spaces



Configurations which do not comply

- (a) opening wider than stud space
- (b) opening narrower than but not within stud space
- (c) two openings, full stud space width, in adjacent stud spaces

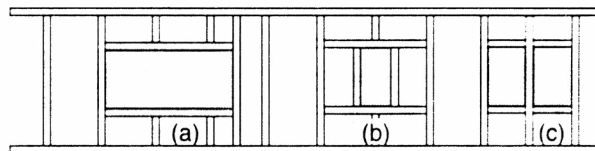


Figure A-9.23.10.6.(2)B.
Single Studs at Openings in All Other Walls

A-9.23.10.7.(2) Stud Posts Supporting Girder Trusses and Beams

Design Assumptions

1. Roof Load = 0.62 kPa (Asphalt shingle roof)
2. Design Standards: CSA 086-01, "Engineering Design in Wood"
3. Design Assumptions:
 - The studs are braced from buckling about their weak axis by the attachment of the wall sheathing.
 - The post is designed for axial loading applied at the centre of the stud cross-section (concentric loading).
 - Stud grade material has been assumed.
 - The stud resistance is based on the compressive resistance parallel to grain (P_r) and the bearing resistance of the wall plate (Q_r).
 - In the calculation of P_r , a system factor (K_H) of 1.0 was used.
 - In the calculation of Q_r , a size factor (K_{zcp}) of 1.15 was used since the wall plate width is greater than two times the thickness. A length of bearing factor (K_B) of 1.0 was used since the stud post can occur at a splice in the wall plate.
 - The post size has been limited to 5 plies.
 - The post size is maintained through all storeys directly below the girder truss or beam until the load is transferred to the foundation wall.

A-9.23.13.11.(2) Wood Roof Truss Connections.

Sentence 9.23.13.11.(2) requires that the connections used in wood roof trusses be designed in conformance with Subsection 4.3.1. The designer of wood trusses should be skilled in the work concerned, since wood roof trusses are complex structures which depend on a number of components (chord members, web members, cross-bracing, connectors) working together to function safely. This complexity precludes the standardization of truss design into tables comprehensive enough to satisfy the variety of roof designs required by the housing industry.

A-9.23.14.2.(4) Water Absorption Test.

A method for determining water absorption is described in ASTM D1037, "Evaluating the Properties of Wood-Base Fiber and Particle Panel Materials". The treatment to reduce water absorption may be considered to be acceptable if a 300 mm x 300 mm sample when treated on all sides and edges does not increase in weight by more than 6% when tested in the horizontal position.

A-9.23.14.4.(2) OSB.

CSA 0437.0, "OSB and Waferboard", requires that Type O (aligned or oriented) panels be marked to show the grade and the direction of face alignment.

A-9.24.3.2.(3) Framing Above Doors in Steel Stud Fire Separations.

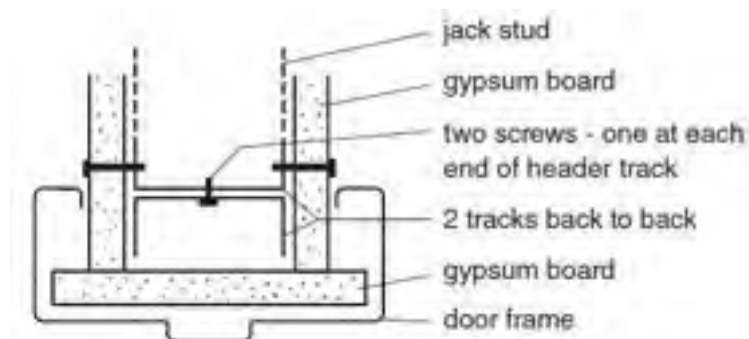


Figure A-9.24.3.2.(3)
Steel Stud Header Detail

A-9.25.2.2.(2) Flame-Spread Ratings of Insulating Materials.

Part 9 has no requirements for flame-spread ratings of insulation materials since these are seldom exposed in parts of buildings where fires are likely to start. Certain of the insulating material standards referenced in Sentence 9.25.2.2.(1) do include flame-spread rating criteria. These are included either because the industry producing the product wishes to demonstrate that their product does not constitute a fire hazard or because the product is regulated by authorities other than building authorities (e.g., Hazardous Products Act). However, the Code cannot apply such requirements to some materials and not to others. Hence, these flame-spread rating requirements are excepted in referencing these standards.

A-9.25.2.3.(3) Position of Insulation.

For thermal insulation to be effective, it must not be short-circuited by convective air flow through or around the material. If low density fibrous insulation is installed with an air space on both sides of the insulation, the temperature differential between the warm and cold sides will drive convective air flow around the insulation. If foam plastic insulation is spot adhered to a back-up wall or adhered in a grid pattern to an air permeable substrate, and is not sealed at the joints and around the perimeter, air spaces between the insulation and the substrate will interconnect with spaces behind the cladding. Any temperature or air pressure differential across the insulation will again lead to short circuiting of the insulation by air flow. Thermal insulation must therefore be installed in full and continuous contact with the air barrier or another continuous component with low air permeance. (See Appendix note A-9.25.5.1.(1) for examples of low-air-permeance materials.)

A-9.25.2.4.(3) Loose-Fill Insulation in Existing Wood Frame Walls.

The addition of insulation into exterior walls of existing wood frame buildings increases the likelihood of damage to framing and cladding components as a result of moisture accumulation. Many older homes were constructed with little or no regard for protection from vapour transmission or air leakage from the interior. Adding thermal insulation will substantially reduce the temperature of the siding or sheathing in winter months, possibly leading to condensation of moisture at this location.

Defects in exterior cladding, flashing and caulking could result in rain entering the wall cavity. This moisture, if retained by the added insulation, could initiate the process of decay.

Steps should be taken therefore, to minimize these effects prior to the retrofit of any insulation. Any openings in walls that could permit leakage of interior heated air into the wall cavity should be sealed. The inside surface should be coated with a low-permeability paint to reduce moisture transfer by diffusion. Finally, the exterior siding, flashing and caulking should be checked and repaired if necessary to prevent rain penetration.

A-9.25.2.4.(5) Loose-Fill Insulation in Masonry Walls.

Typical masonry cavity wall construction techniques do not lend themselves to the prevention of entry of rainwater into the wall space. For this reason, loose-fill insulation used in such space must be of the water repellent type. A test for water-repellency of loose-fill insulation suitable for installation in masonry cavity walls can be found in ASTM C516, "Vermiculite Loose Fill Insulation".

A-9.25.3.1.(1) Air Barrier Systems for Control of Condensation.

The majority of moisture problems resulting from condensation of water vapour in walls and ceiling/attic spaces are caused by the leakage of moist interior heated air into these spaces rather than by the diffusion of water vapour through the building envelope.

Protection against such air leakage must be provided by a system of air-impermeable materials joined with leak-free joints. Generally, air leakage protection can be provided by the use of air-impermeable sheet materials, such as gypsum board or polyethylene of sufficient thickness, when installed with appropriate structural support. However, the integrity of the airtight elements in the air barrier system can be compromised at the joints and here special care must be taken in design and construction to achieve an effective air barrier system.

Although Section 9.25. refers separately to vapour barriers and airtight elements in the air barrier system, these functions in a wall or ceiling assembly of conventional wood frame construction are often combined as a single membrane which acts as a barrier against moisture diffusion and the movement of interior air into insulated wall or roof cavities. Openings cut through

this membrane, such as for electrical boxes, provide opportunities for air leakage into concealed spaces, and special measures must be taken to make such openings as airtight as possible. Attention must also be paid to less obvious leakage paths, such as holes for electric wiring, plumbing installations, wall-ceiling and wall-floor intersections, and gaps created by shrinkage of framing members.

In any case, air leakage must be controlled to a level where the occurrence of condensation will be sufficiently rare, or the quantities accumulated sufficiently small, and drying sufficiently rapid, to avoid material deterioration and the growth of mould and fungi.

Generally the location in a building assembly of the airtight element of the air barrier system is not critical; it can restrict air leakage whether it is located near the outer surface of the assembly, near the inner surface or at some intermediate location. However, if a material chosen to act as an airtight element in the air barrier system also has the characteristics of a vapour barrier (i.e., low permeability to water vapour), its location must be chosen more carefully in order to avoid moisture problems. (See Appendix Notes A-9.25.4.3.(2) and A-9.25.5.1.(1)).

In some assemblies, an airtight element in the air barrier system is the interior finish, such as gypsum board, which is sealed to framing members and adjacent components by gaskets, caulking, tape or other methods to complete the air barrier system. In such cases, special care in sealing joints in a separate vapour barrier is not critical. This approach often uses no separate vapour barrier but relies on appropriate paint coatings to give the interior finish sufficient resistance to water vapour diffusion that it can provide the required vapour diffusion protection.

Section 9.25. allows for such innovative techniques, as well as the more traditional approach of using a continuous sheet, such as polyethylene, to act as an “air/vapour barrier”.

Further information is available in “Moisture Problems in Houses”, by A.T. Hansen, Canadian Building Digest 231, available from the Institute for Research in Construction, National Research Council of Canada, Ottawa K1A 0R6.

A.9.25.3.3.(15) Air Leakage and Soil Gas Control in Floors-on-Ground.

The requirement in Sentence 9.25.3.3.(15) regarding the sealing of penetrations of the air barrier also applies to hollow metal and masonry columns penetrating the floor slab. Not only the perimeters but also the centres of such columns must be sealed or blocked.

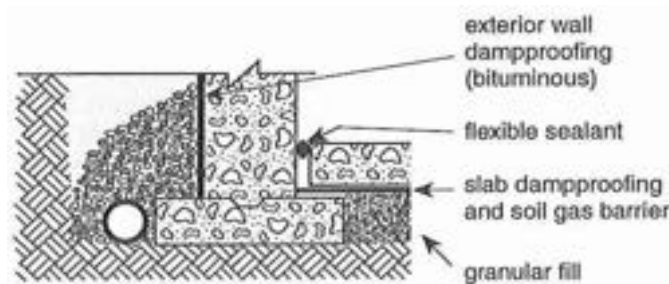


Figure A-9.25.3.3.(15)
Dampproofing and Soil Gas Control at Foundation Wall / Floor Junctions with Solid Walls

A-9.25.4.2.(2) Normal Conditions.

The requirement for a $60 \text{ ng}/(\text{Pa}\cdot\text{s}\cdot\text{m}^2)$ vapour barrier stated in Sentence 9.25.4.2.(1) is based on the assumption that the building assembly is subjected to conditions that are considered normal for typical residential occupancies, and business and personal services occupancies. However, where the intended use of an occupancy includes facilities or activities that will generate a substantial amount of moisture indoors during the heating season, such as swimming pools, greenhouses, laundromats, and any continuous operation of hot tubs and saunas, the building envelope assemblies would have to demonstrate acceptable performance levels in accordance with the requirements in Part 5.

A-9.25.4.3.(2) Location of Vapour Barriers.

Assemblies in which the vapour barrier is located partway through the insulation meet the intent of this Article provided it can be shown that the temperature of the vapour barrier will not fall below the dew point of the heated interior air.

A-9.25.5.1. Location of Low Permeance Materials.

Low Air- and Vapour-Permeance Materials and Implications for Moisture Accumulation

The location in a building assembly of a material with low air permeance is not critical; the material can restrict outward movement of indoor air whether it is located near the outer surface of the assembly, near the inner surface, or at some intermediate location, and such restriction of air movement is generally beneficial, whether or not the particular material is designated as part of the air barrier system. However, if such a material also has the characteristics of a vapour barrier (i.e., low permeability to water vapour) and low thermal resistance, its location must be chosen more carefully in order to avoid moisture accumulation.

Any moisture from the indoor air which diffuses through the inner layers of the assembly or is carried by air leakage through those layers may be prevented from diffusing or being transferred through the assembly by a low air- and vapour-permeance material. This moisture transfer will usually not cause a problem if the material is located where the temperature is above the dew point of the indoor air; the water vapour will remain as vapour, the humidity level in the assembly will come to equilibrium with that of the indoor air, further accumulation of moisture will cease or stabilize at a low rate, and no harm will be done.

But if the low air- and vapour-permeance material is located where the temperature is below the dew point of the air at that location, water vapour will condense and accumulate as water or ice, which will reduce the humidity level and encourage the movement of more water vapour into the assembly. If this temperature remains below the dew point for any length of time, significant moisture could accumulate. When warmer weather returns, the presence of a material with low water vapour permeance can retard drying of the accumulated moisture. Moisture which remains into warmer weather can support the growth of decay organisms.

Due consideration should be given to the properties and location of any material in the building envelope, including paints, liquid-applied or sprayed-on and trowelled-on materials. It is recognized that assemblies that include low air- and vapour-permeance materials are acceptable, but only where these materials are not susceptible to damage from moisture or where they can accommodate moisture (for example insulated concrete walls). Further information on the construction of basement walls may be found in

- Performance Guidelines for Basement Envelope Systems and Materials,” published by NRC-IRC.
- Best Practice Guide Full-Height Basement Insulation Guide, 2008 published by MMAH

Cladding

Different cladding materials have different vapour permeances and different degrees of susceptibility to moisture deterioration. They are each installed in different ways that are more or less conducive to the release of moisture that may accumulate on the inner surface. Sheet or panel-type cladding materials, such as metal sheet, have a vapour permeance less than $60 \text{ ng}/(\text{Pa}\cdot\text{s}\cdot\text{m}^2)$. Sheet metal cladding that has lock seams also has a low air leakage characteristic and so must be installed outboard of a drained and vented air space. Assemblies clad with standard residential vinyl or metal strip siding do not require additional protection as the joints are not so tight as to prevent the dissipation of moisture.

Sheathing

Like cladding, sheathing materials have different vapour permeances and different degrees of susceptibility to moisture deterioration.

Low-permeance sheathing may serve as the vapour barrier if it can be shown that the temperature of the interior surface of the sheathing will not fall below that at which saturation will occur. This may be the case where insulating sheathing is used.

Thermal Insulation

Where low-permeance foamed plastic is the sole thermal insulation in a building assembly, the temperature of the inner surface of this element will be close to the interior temperature. If the foamed plastic insulation has a permeance below $60 \text{ ng}/(\text{Pa}\cdot\text{s}\cdot\text{m}^2)$, it can fulfill the function of a vapour barrier to control condensation within the assembly due to vapour diffusion. However, where low-permeance thermal insulation is installed on the outside of an insulated frame wall, the temperature of the inner surface of the insulation may fall below the dew point. In this case, a the function of vapour barrier has to be provided by a separate building element installed on the warm side of the assembly.

Normal Conditions

The required minimum ratios given in Table 9.25.5.2. are based on the assumption that the building assembly is subjected to conditions that are considered normal for typical residential occupancies, and business and personal services occupancies.

However, where the intended use of an occupancy includes facilities or activities that will generate a substantial amount of moisture indoors during the heating season, such as swimming pools, greenhouses, the operation of a laundromat or any continuous operation of hot tubs and saunas, the building envelope assemblies would have to demonstrate acceptable performance levels in accordance with the requirements in Part 5.

A-9.25.5.1.(1) Air and Vapour Permeance Values.

The air leakage characteristics and water vapour permeance values for a number of common materials are given in Table A-9.25.5.1.(1). These values are provided on a generic basis; proprietary products may have values differing somewhat from those in the Table (consult the manufacturers' current data sheets for their products' values). The values quoted are for the material thickness listed. Water vapour permeance is inversely proportional to thickness: therefore, greater thicknesses will have lower water vapour permeance values.

Table A-9.25.5.1.(1)
Air and Vapour Permeance Values⁽¹⁾

Material	Air Leakage Characteristic, L/(s·m ²) at 75 Pa (Air Permeance)	Water Vapour Permeance, (Dry CuP) 60 ng/(Pa·s·m ²)
Sheet and panel-type materials		
12.7 mm gypsum board	0.02	2600
• painted (1 coat primer)	negligible	1300
• painted (1 coat primer + 2 coats latex paint)	negligible	180
12.7 mm foil-backed gypsum board	negligible	negligible
12.7 mm gypsum board sheathing	0.0091	1373
6.4 mm plywood	0.0084	23 - 74
11 mm oriented strandboard	0.0108	44 (range)
12.5 mm cement board	0.147	590
plywood (from 9.5 mm to 18 mm)	negligible - 0.01	40 - 57
fibreboard sheathing	0.012 - 1.91	100 - 2900
17 mm wood sheathing	high - depends on no. of joints	982
Insulation		
27 mm foil-faced polyisocyanurate	negligible	4.3
27 mm paper-faced polyisocyanurate	negligible	61.1
25 mm extruded polystyrene	negligible	23 - 92
25 mm expanded polystyrene (Type 2)	0.0214	86 - 160
fibrous insulations	very high	very high
25 mm polyurethane spray foam - low density	0.011	894 - 3791
25 mm polyurethane spray foam - medium density	negligible	96(2)
Membrane-type materials		
asphalt-impregnated paper (10 min paper)	0.0673	370
asphalt-impregnated paper (30 min paper)	0.40	650
asphalt-impregnated paper (60 min paper)	0.44	1800
water-resistive barriers (9 materials)	negligible - 4.3	30 - 1200
0.15 mm polyethylene	negligible	1.6 - 5.8
asphalt-saturated felt (#15)	0.153	290
building paper	0.2706	170 - 1400
spun-bonded polyolefin film (expanded)	0.9593	3646
Other materials		
brick (6 materials)	negligible	102 - 602
metal	negligible	negligible
mortar mixes (4 materials)	negligible	13 - 690
stucco	negligible	75 - 240
50 mm reinforced concrete (density: 2 330 kg/m ³)	negligible	23

Notes to Table A-9.25.5.1.(1)

(1) Air leakage and vapour permeance values derived from:

- Bombaru, D., Jutras, R. and Patenaude, A. Air Permeance of Building Materials. Summary Report prepared by AIR-INS Inc. for Canada Mortgage and Housing Corporation, Ottawa, 1988. Values indicate properties of tested materials only; values for specific products may vary significantly.
- Details of Air Barrier Systems for Houses. Tarion Warranty Corporation (formerly Ontario New Home Warranty Program), Toronto, 1993.
- Kumaran, M.K., et al., ASHRAE Research Report 1018 RP, A Thermal and Moisture Transport Property Database for Common Building and Insulating Materials.
- Kumaran, M.K., Lackey, J., Normandin, N., van Reenen, D., Tariku, F., Summary Report from Task 3 of MEWS Project at the Institute for Research in Construction-Hygrothermal Properties of Several Building Materials, IRC- RR-110, March 2002.
- Mukhopadhyaya, P., Kumari M.K., et al., Hygrothermal Properties of Exterior Claddings, Sheathing Boards, Membranes and Insulation Materials for Building Envelope Design, Proceedings of Thermal Performance of the Exterior Envelopes of Whole Building X, Clearwater, Florida, December 2-7, 2007, pp. 1-16 (NRCC-50287).

(2) This water vapour permeance value is for a 25 mm thick core layer of medium density polyurethane spray foam. When installed in the field, a low permeance resin layer forms where the foam is in contact with the substrate. The water vapour permeance of the installed foam, were it measured including the resin layer, would therefore likely be lower than the value listed in the Table.

a10.1 A-9.25.5.1.(1)(a)(ii) Reduced Potential for Condensation in the Building Envelope.

The requirements in Article 9.25.5.2. aim to reduce the risk of condensation being introduced into wall assemblies due to the water vapour permeance of the outboard materials. Research has confirmed that the reduced condensation potential of exterior continuous insulation with a thermal resistance of at least $0.7 \text{ (m}^2\cdot\text{K)/W}$ and a water vapour permeance between 30 and $1\,800 \text{ ng/(Pa}\cdot\text{s}\cdot\text{m}^2)$ compares to reference assemblies without exterior insulation in a given geographic location and climatic exposure.

a10.1 A-9.25.5.1.(3) Wood-Based Sheathing Materials.

Wood-based sheathing materials, such as plywood and OSB, that are not more than 12.5 mm thick are exempt from complying with Sentence 9.25.5.1.(1) because wood has an adaptive vapour permeance based on relative humidity: it has a low vapour permeance in an environment with low relative humidity and a higher vapour permeance in an environment with high relative humidity (see Figure A-9.25.5.1.(3)). This adaptive vapour permeance means that wood-based materials located on the outboard side of an assembly in winter, where the RH is typically 75% or higher, are relatively vapour-open, thus allowing greater vapour movement. The same wood-based material located on the inboard side of an assembly, where the RH is typically much lower in winter, has a low vapour permeance, thus mitigating the movement of vapour.

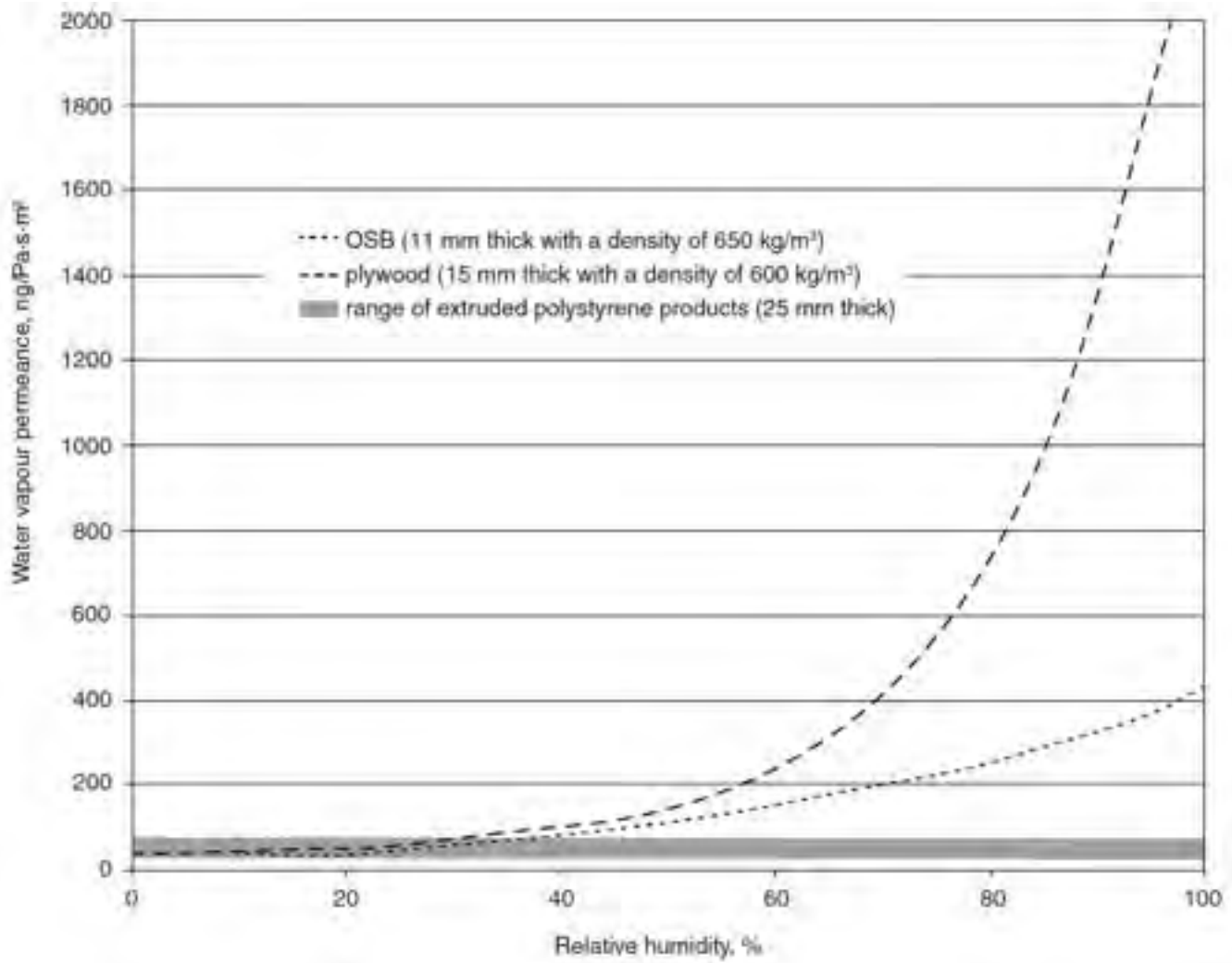


Figure A-9.25.5.1.(3)
Adaptive Water Vapour Permeance of Wood-Based Sheathing Materials

A-9.25.5.2. Assumptions Followed in Developing Table 9.25.5.2.

Article 9.25.5.2. specifies that a low air- and vapour-permeance material must be located on the warm face of the assembly, outboard of a vented air space, or within the assembly at a position where its inner surface is likely to be warm enough for most of the heating season such that no significant accumulation of moisture will occur. This last position is defined by the ratio of the thermal resistance values outboard and inboard of the innermost impermeable surface of the material in question

The design values given in Table 9.25.5.2. are based on the assumption that the building includes a mechanical ventilation system (between 0.3 and 0.5 air changes per hour), a $60 \text{ ng}/(\text{Pa}\cdot\text{s}\cdot\text{m}^2)$ vapour barrier, and an air barrier (values between 0.024 and $0.1 \text{ L}/(\text{s}\cdot\text{m}^2)$ through the assembly were used). The moisture generated by occupants and their use of bathrooms, cleaning, laundry and kitchen appliances was assumed to fall between 7.5 and 11.5 L per day.

It has been demonstrated through modelling under these conditions that assemblies constructed according to the requirements in Table 9.25.5.2. do not lead to moisture accumulation levels that may lead to deterioration as long as the average monthly vapour pressure difference between the exterior and interior sides over the heating season does not increase above 750 Pa , which would translate into an interior relative humidity (RH) of 35% in colder climates and 60% in mild climates.

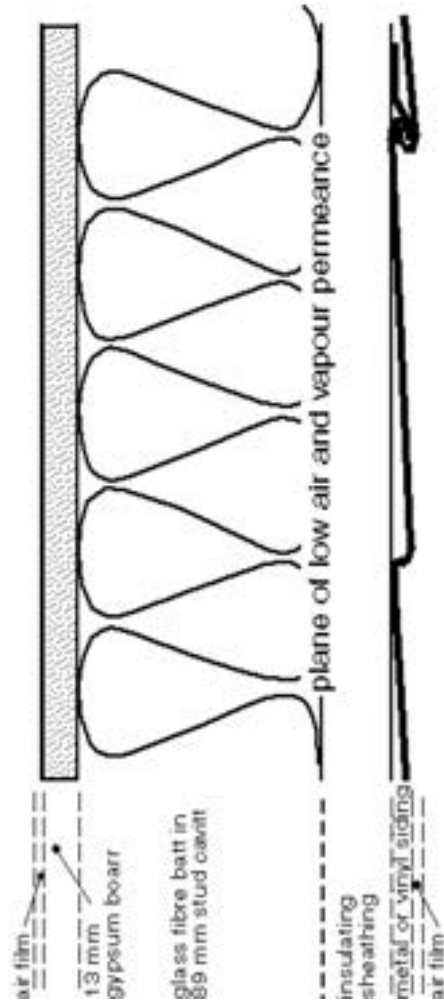
Health Canada recommends indoor relative humidities between 35% and 50% for healthy conditions. ASHRAE accepts a 30% to 60% range. Environments that are much drier tend to exacerbate respiratory problems and allergies; more humid environments tend to support the spread of microbes, moulds and dust mites, which can adversely affect health.

In most of Canada in the winter, indoor RH is limited by the exterior temperature and the corresponding temperature on the inside of windows. During colder periods, indoor RH higher than 35% will cause significant condensation on windows. When this occurs, occupants are likely to increase the ventilation to remove excess moisture. Although indoor RH may exceed 35% for short periods when the outside temperature is warmer, the criteria provided in Table 9.25.5.2. will still apply. Where higher relative humidities are maintained for extended periods in these colder climates, the ratios listed in the Table may not provide adequate protection.

Table 9.25.5.2. cannot be used for occupancies that require that RH be maintained above 35% throughout the year and for those interior spaces that support activities, such as swimming, that create high relative humidities. In these cases the position of the materials must be determined according to Part 5.

It should be noted that Part 9 building envelopes in regions with colder winters have historically performed acceptably when the indoor RH does not exceed 35% over most of the heating season. With tighter building envelopes, it is possible to raise indoor RH levels above 35% . There is no information, however, on how Part 9 building envelopes will perform when exposed to these higher indoor RH levels for extended periods during the heating season over many years. Operation of the ventilation system, as intended to remove indoor pollutants, will maintain the lower RH levels as necessary.

The method of calculating the inboard to outboard thermal resistance ratio is illustrated in Figure A-9.25.5.2. The example wall section shows three planes where low air- and vapour-permeance materials have been installed. A vapour barrier, installed to meet the requirements of Subsection 9.25.4., is on the warm side of the insulation consistent with Clause 9.25.1.2.(1)(a) and Sentences 9.25.4.1.(1) and 9.25.4.3.(2). The vinyl siding has an integral drained and vented air space consistent with Clause 9.25.1.2.(1)(c). The position of the interior face of the low-permeance insulating sheathing, however, must be reviewed in terms of its thermal resistance relative to the overall thermal resistance of the wall, and the climate where the building is located.



	Inboard			Outboard		
RSI value	0.12	0.08	2.11	0.87	0.12	0.03
Total RSI value	2.31			1.02		
Ratio	$1.02 / 2.31 = 0.44$					

Figure A-9.25.5.2.
 Example Wall Section Showing Thermal Resistance Inboard and Outboard of a Plane of Low Air and Vapour Permeance

Comparing the RSI ratio from the example wall section with those in Table 9.25.5.2. indicates that this wall would be acceptable in areas with Celsius degree-day values up to 7999, which includes, for example, Geraldton. (Degree-day values for various locations in Ontario are provided in MMAH Supplementary Standard SB-1.

A similar calculation would indicate that, for a similar assembly but with a 140 mm stud cavity filled with an RSI 3.52 batt, the ratio would be 0.28. Thus such a wall could be used in areas with Celsius degree-day values up to 4999, which includes, for example, Ottawa.

Similarly, if half the thickness of the same low permeance sheathing were used, the ratio with an 89 mm cavity would be 0.25, permitting its use in areas with Celsius degree-day values up to 4999. The ratio with a 140 mm cavity would be 0.16; thus this assembly could not be used anywhere, since this ratio is below the minimum permitted in Table A-9.25.5.2.

Table A-9.25.5.2. shows the minimum thicknesses of low permeance insulating sheathing necessary to satisfy Article 9.25.5.2. in various degree-day zones for a range of resistivity values of insulating sheathing. These thicknesses are based on the detail shown in Figure A-9.25.5.2. but could also be used with cladding details, such as brick veneer or wood siding, which provide equal or greater outboard thermal resistance.

Table A-9.25.5.2.
Minimum Thicknesses of Low Permeance Insulating Sheathing

Celsius Heating Degree-days	Min. RSI Ratio	38 x 89 mm Framing					38 x 140 mm Framing				
		Min. Outboard Thermal Resistance, RSI	Min. Sheathing Thickness, mm				Min. Outboard Thermal Resistance, RSI	Min. Sheathing Thickness, mm			
			Sheathing Thermal Resistance, RSI/mm					Sheathing Thermal Resistance, RSI/mm			
			0.0300	0.0325	0.0350	0.0400		0.0300	0.0325	0.0350	0.0400
≤ 4999	0.20	0.46	10	10	9	8	0.72	19	17	16	14
5000 to 5999	0.30	0.69	18	17	16	14	1.07	31	28	26	23
6000 to 6999	0.35	0.81	22	20	19	16	1.25	37	34	32	28
7000 to 7999	0.40	0.92	26	24	22	19	1.43	43	39	37	32
Column 1	2	3	4	5	6	7	8	9	10	11	12

References

- (1) Exposure Guidelines for Residential Indoor Air Quality, Environmental Health Directorate, Health Protection Branch, Health Canada, Ottawa, April 1987 (Revised July 1989).
- (2) ANSI/ASHRAE 62, "Ventilation for Acceptable Indoor Air Quality."

a10.1 A-9.26.1.1.(1) Platforms that Effectively Serve as Roofs.

Decks, balconies, exterior walkways and similar exterior surfaces effectively serve as roofs where these platforms do not permit the free drainage of water through the deck. When water is driven by wind across the deck (roof) surface, it can be driven upward when it encounters an interruption.

A-9.26.2.2.(4) Fasteners for Treated Shingles.

Where shingles or shakes have been chemically treated with a preservative or a fire retardant, the fastener should be of a material known to be compatible with the chemicals used in the treatment.

A-9.26.4.1. Junctions Between Roofs and Walls or Guards.

Drainage of water from decks and other platforms that effectively serve as roofs will be blocked by walls, and blocked or restricted by guards where significant lengths and heights of material are connected to the deck. Without proper flashing at such roof-wall junctions or roof-guard junctions, water will generally leak into the adjoining elements and can penetrate into supporting assemblies below. Exceptions include platforms where waterproof curbs of sufficient height are cast-in or where the deck and wall or guard are unit-formed. In these cases, the monolithic deck-wall or deck-guard junctions will minimize the likelihood of water ingress. (See also Appendix Note A-9.26.1.1.(2).)

A-9.26.6.1.(1) Underlay Beneath Shingles.

While underlayment has not traditionally been required by the Code, some shingle manufacturers require its use beneath their products.

A-9.26.17.1.(1) Installation of Concrete Roof Tiles.

Where concrete roof tiles are to be installed, the dead load imposed by this material should be considered in determining the minimum sizes and maximum spans of the supporting roof members.

a10.1 A-9.27.1.1.(5) EIFS on Walls with Cold-Formed Steel Stud Framing.

While Part 9 permits the installation of exterior insulation finish systems on walls with cold-formed steel stud framing, the design of loadbearing steel walls is outside the scope of Part 9 and is addressed in Part 4 (see Sentence 9.24.1.1.(2)).

A-9.27.2. Required Protection from Precipitation.

Part 5 and Part 9 of the Building Code recognize that mass walls and face-sealed, concealed barrier and rainscreen assemblies have their place in the Canadian context.

Mass walls are generally constructed of cast-in-place concrete or masonry. Without cladding or surface finish, they can be exposed to precipitation for a significant period before moisture will penetrate from the exterior to the interior. The critical characteristics of these walls are related to thickness, mass, and moisture transfer properties, such as shedding, absorption and moisture diffusion.

Face-sealed assemblies have only a single plane of protection. Sealant installed between cladding elements and other envelope components is part of the air barrier system and is exposed to the weather. Face-sealed assemblies are appropriate where it can be demonstrated that they will provide acceptable performance with respect to the health and safety of the occupants, the operation of building services and the provision of conditions suitable for the intended occupancy. These assemblies, however, require more intensive, regular and on-going maintenance, and should only be selected on the basis of life-cycle costing considering the risk of failure and all implications should failure occur. Climate loads such as wind-driven rain, for example, should be considered. Face-sealed assemblies are not recommended where the building owner may not be aware of the maintenance issue or where regular maintenance may be problematic.

Concealed barrier assemblies include both a first and second plane of protection. The first plane comprises the cladding, which is intended to handle the majority of the precipitation load. The second plane of protection is intended to handle any water that penetrates the cladding plane. It allows for the dissipation of this water, primarily by gravity drainage, and provides a barrier to further ingress.

Like concealed barrier assemblies, rainscreen assemblies include both a first and second plane of protection. The first plane comprises the cladding, which is designed and constructed to handle virtually all of the precipitation load. The second plane of protection is designed and constructed to handle only very small quantities of incidental water; composition of the second plane is described in Appendix Note A-9.27.3.1. In these assemblies, the air barrier system, which plays a role in controlling precipitation ingress due to air pressure difference, is protected from the elements. (See Figure A-9.27.2.)

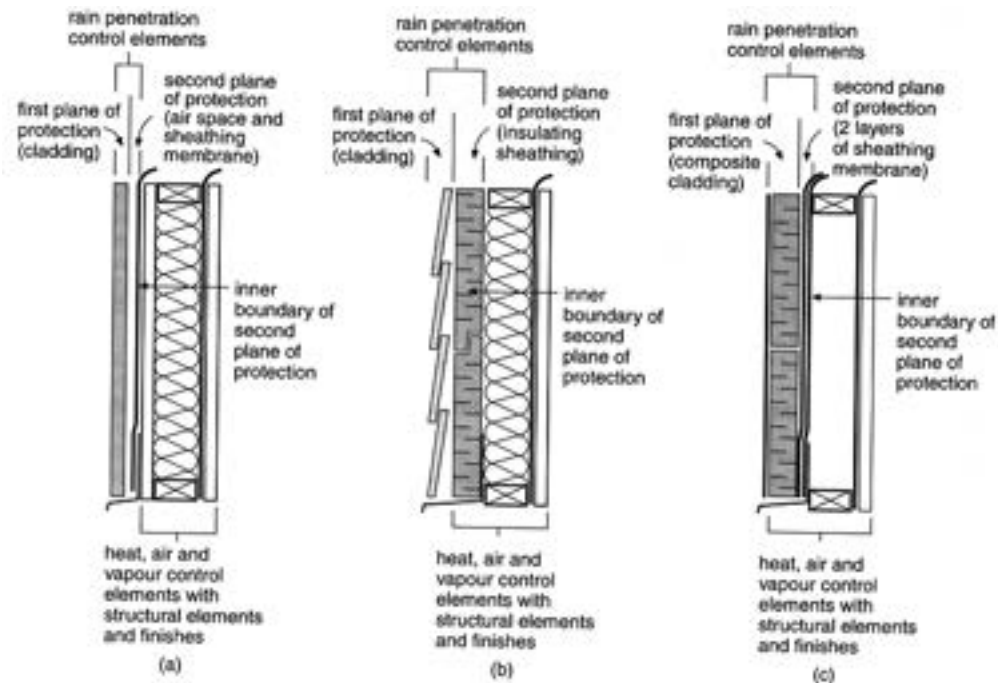


Figure A-9.27.2.
Generic Rainscreen Assemblies

A-9.27.2.1.(1) Minimizing Precipitation Ingress.

The total prevention of precipitation ingress into wall assemblies is difficult to achieve and, depending on the wall design and construction, may not be absolutely necessary. The amount of moisture that enters a wall, and the frequency with which this occurs, must be limited. The occurrence of ingress must be sufficiently rare, accumulation sufficiently small and drying sufficiently rapid to prevent the deterioration of moisture-susceptible materials and the growth of fungi.

A-9.27.2.2.(1) Required Levels of Protection from Precipitation.

Part 9 provides guidance to assist in determining the minimum levels of protection from precipitation to be provided by cladding assemblies. Article 9.27.2.2. describes the minimum cladding assembly configuration. Designers must still consider local accepted good practice, demonstrated performance and the specific conditions to which a particular wall will be exposed when designing or selecting a cladding assembly.

A.9.27.3.1. Second Plane of Protection.

As specified in Sentence 9.27.3.1.(1), the second plane of protection consists of a drainage plane with an appropriate material serving as the inner boundary and flashing to dissipate rainwater or meltwater to the exterior.

Drainage Plane

Except for masonry walls, the simplest configuration of a drainage plane is merely a vertical interface between materials that will allow gravity to draw the moisture down to the flashing to allow it to dissipate to the exterior. It does not necessarily need to be constructed as a clear drainage space (air space).

For masonry walls, an open rainscreen assembly is required; that is, an assembly with first and second planes of protection where the drainage plane is constructed as a drained and vented air space. Such construction also constitutes best practice for walls other than masonry walls.

Section 9.20. requires drainage spaces of 25 mm for masonry veneer walls and 50 mm for cavity walls. In other than masonry walls, the drainage space in an open rainscreen assembly should be at least 10 mm deep. Drainage holes must be designed in conjunction with the flashing.

Sheathing Membrane

The sheathing membrane described in Article 9.27.3.2. is not a waterproof material. When installed to serve as the inner boundary of the second plane of protection, and when that plane of protection includes a drainage space at least 10 mm deep, the performance of the identified sheathing membrane has been demonstrated to be adequate. This is because the material is expected to have to handle only a very small quantity of water that penetrates the first plane of protection.

If the 10 mm drainage space is reduced or interrupted, the drainage capacity and the capillary break provided by the space will be reduced. In these cases, the material selected to serve as the inner boundary may need to be upgraded to provide greater water resistance in order to protect moisture-susceptible materials in the backing wall.

Appropriate Level of Protection

It is recognized that many cladding assemblies with no space or with discontinuous space behind the cladding, and with the sheathing membrane material identified in Article 9.27.3.2., have provided acceptable performance with a range of precipitation loads imposed on them. Vinyl and metal strip siding, and shake and shingle cladding, for example, are installed with discontinuous drained spaces, and have demonstrated acceptable performance in most conditions. Lapped wood and composite strip sidings, depending on their profiles, may or may not provide discontinuous spaces, and generally provide little drainage. Cladding assemblies with limited drainage capability that use a sheathing membrane meeting the minimum requirements are not recommended where they may be exposed to high precipitation loads or where the level of protection provided by the cladding is unknown or questionable. Local practice with demonstrated performance should be considered. (See also Article 9.27.2.2. and Appendix Note A-9.27.2.2.(1)).

A-9.27.3.4.(2) Detailing of Joints in Exterior Insulating Sheathing.

The shape of a joint is critical to its ability to shed water. Tongue and groove, and lapped joints can shed water if oriented correctly. Butt joints can drain to either side and so should not be used unless they are sealed. However, detailing of joints requires attention not just to the shape of the joint but also to the materials that form the joint. For example, even if properly shaped, the joints in insulating sheathing with an integral sheathing membrane could not be expected to shed water if the insulating material absorbs water, unless the membrane extends through the joints.

A-9.27.3.5.(1) Sheathing Membranes in Lieu of Sheathing.

Article 9.23.16.1., Required Sheathing, indicates that sheathing must be installed only where the cladding requires intermediate fastening between supports (studs) or where the cladding requires a solid backing. Cladding such as brick or panels would be exempt from this requirement and in these cases a double layer of sheathing membrane would generally be needed. The exception (Article 9.27.3.6.) applies only to those types of cladding that provide a face seal to the weather.

A-9.27.3.6. Sheathing Membrane Under Face Sealed Cladding.

The purpose of sheathing membrane on walls is to reduce air infiltration and to control the entry of wind-driven rain. Certain types of cladding consisting of very large sheets or panels with well-sealed joints will perform this function, eliminating the need for sheathing membrane. This is true of the metal cladding with lock-seamed joints sometimes used on mobile homes. However, it does not apply to metal or plastic siding applied in narrow strips which is intended to simulate the appearance of lapped wood siding. Such material does not act as a substitute for sheathing membrane since it incorporates provision for venting the wall cavity and has many loosely-fitted joints which cannot be counted on to prevent the entry of wind and rain.

Furthermore, certain types of sheathing systems can perform the function of the sheathing membrane. Where it can be demonstrated that a sheathing material is at least as impervious to air and water penetration as sheathing membrane and that its jointing system results in joints that are at least as impervious to air and water penetration as the material itself, sheathing membrane may be omitted.

A-9.27.3.8.(1) Required Flashing.

Horizontal Offsets

Where a horizontal offset in the cladding is provided by a single cladding element, there is no joint between the offset and the cladding above. In this case, and provided the cladding material on the offset provides effective protection for the construction below, flashing is not required.

Changes in Substrate

In certain situations, flashing should be installed at a change of substrate: for example, where stucco cladding is installed on a wood-frame assembly, extending down over a masonry or cast-in-place concrete foundation and applied directly to it. Such an application does not take into account the potential for shrinkage of the wood frame and cuts off the drainage route for moisture that may accumulate behind the stucco on the frame construction.

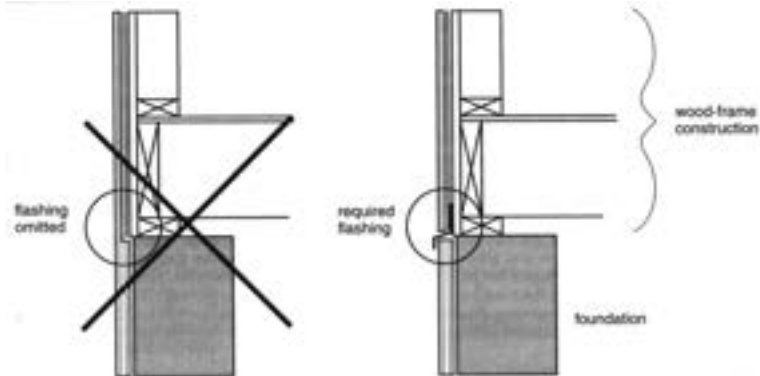


Figure A-9.27.3.8.(1)
Flashing at Change in Substrate

A.9.27.3.8.(3) Flashing Over Curved-Head Openings.

The requirement for flashing over openings depends on the vertical distance from the top of the trim over the opening to the bottom of the eave compared to the horizontal projection of the eave. In the case of curved-head openings, the vertical distance from the top of the trim increases as one moves away from the centre of the opening. For these openings, the top of the trim must be taken as the lowest height before the trim becomes vertical. (See Figure A-9.27.3.8.(3).)

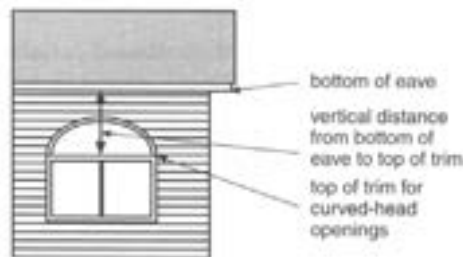


Figure A-9.27.3.8.(3)
Flashing Over Curved-Head Openings

A-9.27.3.8.(4) Flashing Configuration and Positive Drainage.

Flashing Configuration

A 6% slope is recognized as the minimum that will provide effective flashing drainage. The 10 mm vertical lap over the building element below and the 5 mm offset are prescribed to reduce transfer by capillarity and surface tension.

Figure A-9.27.3.8.(4) illustrates two examples of flashing configurations.

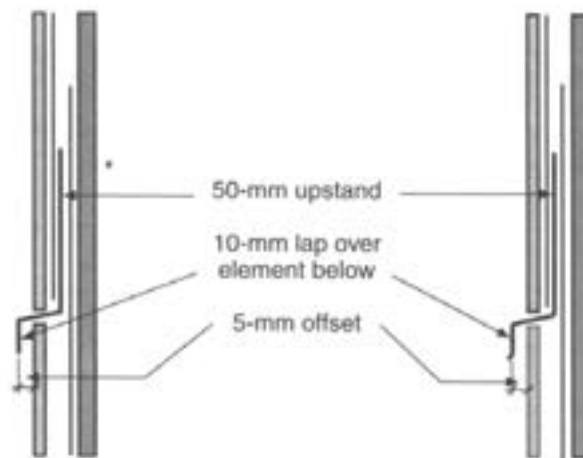


Figure A-9.27.3.8.(4)
Examples of Flashing Configurations Showing Upstands, Horizontal Offsets and Vertical Laps

Maintaining Positive Slope

Sentence 9.27.3.8.(4) requires that the minimum 6% flashing slope remain after expected shrinkage of the building frame. Similarly, Sentence 9.26.3.1.(4) requires that a positive slope remain on roofs and similar assemblies after expected shrinkage of the building frame.

For Part 9 wood-frame construction, expected wood shrinkage can be determined based on the average equilibrium moisture content (MC) of wood, within the building envelope assembly. According to the Canadian Wood Council's Wood Reference Handbook, the equilibrium moisture content (equilibrium MC) for wood in Ontario is 8%.

For three-storey construction to which Part 9 applies, the cumulative longitudinal shrinkage is negligible. Shrinkage need only be calculated for horizontal framing members using the following formula (from Introduction to Wood Building Technology, Canadian Wood Council, Ottawa, 1997):

$$\text{Shrinkage} = (\text{total horizontal member height}) \times (\text{initial MC} - \text{equilibrium MC}) \times (0.002)$$

A-9.27.3.8.(5) Protection Against Precipitation Ingress at the Sill-to-Cladding Joint.

Many windows are configured in such a way that a line of sealant is the only protection against water ingress at the sill-to-cladding joint & a location that is exposed to all of the water that flows down the window. In the past, many windows were constructed with self-flashing sills & sills that extend beyond the face of the cladding and have a drip on the underside to divert water away from the sill-to-cladding joint. This sill configuration was considered to be accepted good practice and is recognized today as providing a degree of redundancy in precipitation protection.

Self-flashing sills are sills that

- slope toward the exterior where the sills have an upward facing surface that extends beyond the jambs,
- where installed over a masonry sill, extend not less than 25 mm beyond the inner face of that sill,
- incorporate a drip positioned not less than 5 mm outward from the outer face of the cladding below or not less than 15 mm beyond the inner edge of a masonry sill, and

- terminate at the jambs or, where the face of the jambs is not at least flush with the face of the cladding and the sills extend beyond the jambs, incorporate end dams sufficiently high to protect against overflow in wind-driven rain conditions.

A wind pressure of 10 Pa can raise water 1 mm. Thus, for example, if a window is exposed to a driving rain wind pressure of 200 Pa, end dams should be at least 20 mm high.

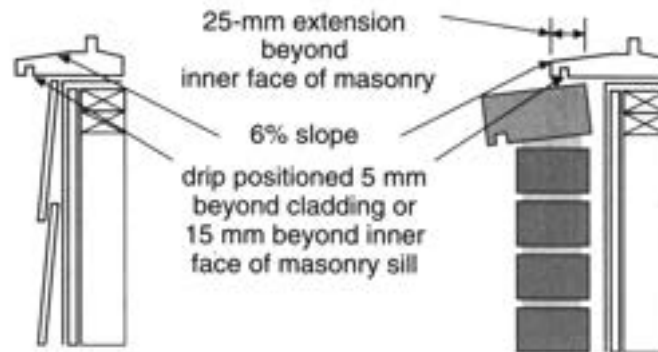


Figure A-9.27.3.8.(5)
Examples of Configurations of Self-Flashing Sills

A-9.27.4.2.(1) Selection and Installation of Sealants.

Analysis of many sealant joint failures indicates that the majority of failures can be attributed to improper joint preparation and deficient installation of the sealant and various joint components. The following ASTM guidelines describe several aspects that should be considered when applying sealants in unprotected environments to achieve a durable application:

- ASTM C1193, "Use of Joint Sealants,"
- ASTM C1299, "Selection of Liquid-Applied Sealants,"
- ASTM C1472, "Calculating Movement and Other Effects When Establishing Sealant Joint Width."

The sealant manufacturer's literature should always be consulted for recommended procedures and materials.

A-9.27.9.2.(3) Grooves in Hardboard Cladding.

Grooves deeper than that specified may be used in thicker cladding providing they do not reduce the thickness to less than the required thickness minus 1.5 mm. Thus for Type 1 or 2 cladding, grooves must not reduce the thickness to less than 4.5 mm or 6 mm depending on method of support, or to less than 7.5 mm for Type 5 material.

A-9.27.10.2.(2) Thickness of Grade O-2 OSB.

In using Table 9.27.8.2. to determine the thickness of Grade O-2 OSB cladding, substitute "face orientation" for "face grain" in the column headings.

A-9.27.11.1.(3) and (4) Material Standards for Aluminum Cladding.

Compliance with Sentence 9.27.11.1.(3) and CAN/CGSB-93.2-M, "Prefinished Aluminum Siding, Soffits, and Fascia for Residential Use", is required for aluminum siding that is installed in horizontal or vertical strips. Compliance with Sentence 9.27.11.1.(4) and CAN/CGSB-93.1-M, "Sheet, Aluminum Alloy, Prefinished, Residential", is required for aluminum cladding that is installed in large sheets.

a10.1 A-9.27.13.1.(1) Geometrically Defined Drainage Cavity.

“Geometrically defined drainage cavity” (GDCC) refers to the channels, grooves or profiles cut into the insulation backing of an EIFS panel for the purpose of providing a way for water that gets behind the system to drain out. The channels, grooves or profiles of one panel need to connect to the channels, grooves or profiles of adjacent panels in order for drainage to occur consistently and uniformly across the entire EIFS. While the size of a channel, groove or profile can be verified by inspecting a single panel, the intent of Sentence 9.27.13.1.(1) is that the required drainage capacity be achieved across the entire system.

Additional information on the design and installation of EIFS can be found in

- the EIFS Practice Manual published by the EIFS Council of Canada, and
- the manufacturer's literature.

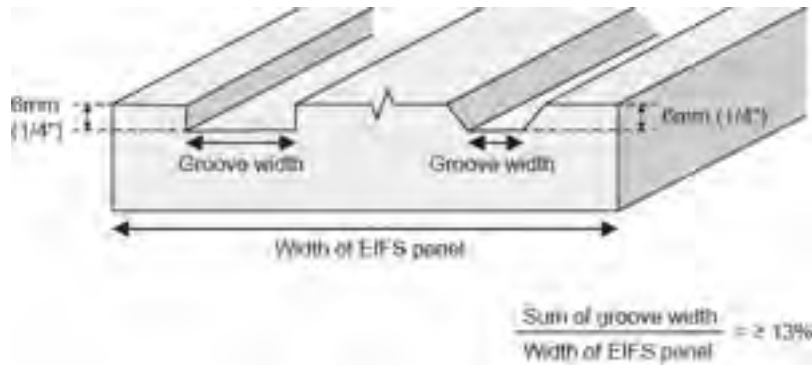


Figure A-9.27.13.1.(1)
Geometrically Defined Drainage Cavity

a10.1 A-9.27.13.2.(2)(a) Substrates for Exterior Insulation Finish Systems.

The list of acceptable substrates for each type of EIFS can be found in a system's respective test report to CAN/ULC-S716.1, “Exterior Insulation and Finish Systems (EIFS) – Materials and Systems”; however, the following substrates are generally considered acceptable:

- minimum 11 mm thick exposure 1 OSB classified as PS2 exterior wall sheathing
- minimum 11 mm thick exterior-rated plywood sheathing
- minimum 12.7 mm thick exterior gypsum sheathing conforming to ASTM C1177 / C1177M, “Glass Mat Gypsum Substrate for Use as Sheathing”
- cementitious panels
- fibre-cement panels
- concrete block
- clay masonry
- cast-in-place concrete

Note that, in some cases, the list of acceptable substrates may be limited by the EIFS manufacturer.

A-Table 9.28.4.3. Stucco Lath.

Paper-backed welded wire lath may also be used on horizontal surfaces provided its characteristics are suitable for such application.

A-9.30.1.2.(1) Water Resistance.

In some areas of buildings, water and other substances may frequently be splashed or spilled onto the floor. It is preferable, in such areas, that the finish flooring be a type that will not absorb moisture or permit it to pass through; otherwise, both the flooring itself and the subfloor beneath it may deteriorate. Also, particularly in food preparation areas and bathrooms, unsanitary conditions may be created by the absorbed moisture. Where absorbent or permeable flooring materials are used in these areas, they should be installed in such a way that they can be conveniently removed periodically for cleaning or replacement, i.e., they should not be glued or nailed down. Also, if the subfloor is a type that is susceptible to moisture damage (this includes virtually all of the wood-based subfloor materials used in wood frame construction), it should be protected by an impermeable membrane placed between the finish flooring and the subfloor. The minimum degree of impermeability required by Sentence 9.30.1.2.(1) would be provided by such materials as polyethylene, aluminum foil, and most single-ply roofing membranes (EPDM, PVC).

A-9.31.6.2.(3) Securement of Service Water Heaters.

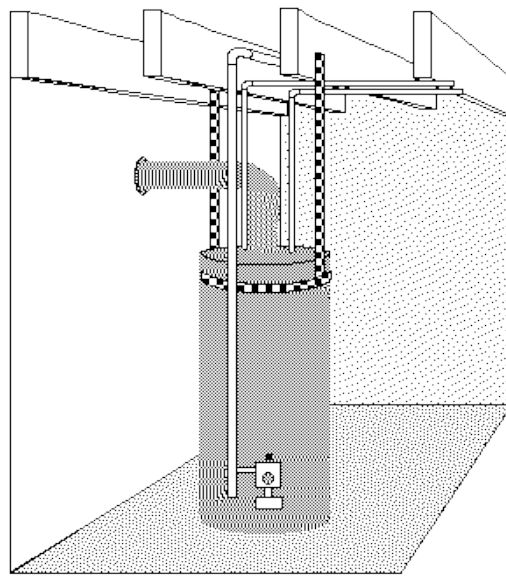


Figure A-9.31.6.2.(3)
Securement of Service Water Heater Using Strapping Fastened to Floor Joists Overhead

A-9.32.3. Mechanical Ventilation.

For many years, houses were constructed without mechanical ventilation systems and relied on natural air leakage through the building envelope for winter ventilation. However, houses have become progressively more airtight through the introduction of new products and practices, e.g., the substitution of panel sheathings such as plywood and waferboard for board sheathing, the replacement of paper-backed insulation batts with friction-fit batts and polyethylene film, improved caulking materials, tighter windows and doors, and more efficient heating systems. Following the energy crisis in the early 1970's, considerable emphasis was placed on reducing air leakage in order to conserve energy. Electric heating systems were encouraged and higher efficiency furnaces were developed, which further reduced air change rates in buildings. This led to concern that the natural air change in dwelling units might be insufficient in some instances to provide adequate indoor air quality. Condensation problems resulting from higher humidity levels were also a concern.

Mechanical ventilation requirements in the Building Code have evolved from a simple requirement in the 1983 edition that exhaust fans be incorporated in electrically heated houses, through requirements in the 1986 and 1990 editions that all houses have mechanical ventilation systems capable of exchanging the indoor air for outdoor air at a specified rate: 0.5 air changes per hour in the 1986 edition and 0.3 air changes per hour in the 1990 edition. The current requirements address not only the overall air change rate created by the mechanical ventilation system but also the need to ensure that the outdoor air brought into the house by the system is distributed throughout the house.

A-9.33.1.1. Combustion Air and Tight Houses.

The operation of an air exhaust system or of a fuel-burning appliance removes the air from a house, creating a slight negative pressure inside. In certain cases the natural flow of air up a chimney can be reversed, leading to a possible danger of carbon monoxide poisoning for the inhabitants.

Newer houses are generally more tightly constructed than older ones because of improved construction practices, including tighter windows, weather stripping and caulking. This fact increases the probability that infiltration may not be able to supply enough air to compensate for simultaneous operation of exhaust fans, fireplaces, clothes dryers, furnaces and space heaters. It is necessary, therefore, to introduce outside air to the space containing the fuel-burning appliance. Information regarding combustion air requirements for various types of appliances can be found in the installation standards referenced in Articles 6.2.1.4. and 9.33.1.2. In the case of solid-fuel burning stoves, ranges and space heaters, CAN/CSA-B365, “Installation Code for Solid-Fuel-Burning Appliances and Equipment” suggests that the minimum size of openings be determined by trial and error to accommodate the flue characteristics, the firing rate, the building characteristics, etc., and that, as a guide, the combustion air opening should be 0.5 times the flue collar area.

Further information is available in Canadian Building Digest 222, “Airtight Houses and Carbon Monoxide Poisoning”, from the Institute for Research in Construction, National Research Council of Canada, Ottawa K1A 0R6.

A-9.33.1.2.(1) Design, Construction and Installation Standard for Solid-Fuel-Burning Appliances.

CSA B365, “Installation Code for Solid-Fuel-Burning Appliances and Equipment” is essentially an installation standard, and covers such issues as accessibility, air for combustion and ventilation, chimney and venting, mounting and floor protection, wall and ceiling clearances, installation of ducts, pipes, thimbles and manifolds, and control and safety devices. But the standard also includes a requirement that solid-fuel-burning appliances and equipment satisfy the requirements of one of a series of standards, depending on the appliance or equipment, therefore also making it a design and construction standard. It is required that stoves, ranges, central furnaces and other space heaters be designed and built in conformity with the relevant referenced standard.

a10.1 A-9.33.1.2.(2) Emission Limits.

CSA B415.1-10 and the US EPA Standard cover appliances that burn biomass fuels other than coal and require appliances equipped with catalytic combustors have an average particulate emission rate ≤ 2.5 g/h and appliances not equipped with catalytic combustors have an average particulate emission rate ≤ 4.5 g/h. Both CSA and EPA test particulate emissions using the same testing methods. These standards do not cover site-built masonry fireplaces or site-built masonry heaters. They do not apply to factory-built fireplaces with a minimum burn rate ≥ 5 kg/h.

A-9.33.4. Carbon Monoxide Alarms.

Carbon monoxide (CO) is a colourless, odourless gas that can build up to lethal concentrations in an enclosed space without the occupants being aware of it. Thus, where an enclosed space incorporates or is near a potential source of CO, it is prudent to provide some means of detecting its presence.

Dwelling units have two common potential sources of CO:

- fuel-fired space- or water-heating equipment within the dwelling unit or in adjacent spaces within the building, and
- attached storage garages.

Most fuel-fired heating appliances do not normally produce CO and, even if they do, it is normally conveyed outside the building by the appliance’s venting system. Nevertheless, appliances can malfunction and venting systems can fail. Therefore, the provision of appropriately placed CO alarms in the dwelling unit is a relatively low-cost back-up safety measure. Similarly, although Article 9.10.9.16. requires that the walls and floor/ceiling assemblies separating attached garages from dwelling units incorporate an air barrier system, there have been several instances of CO from garages being drawn into houses, which indicates that a fully gas-tight barrier is difficult to achieve. The likelihood of preventing the entry of all CO is decreased if the dwelling unit is depressurized in relation to the garage. This can readily occur due to the operation of exhaust equipment or simply due to the stack effect created by heating the dwelling unit. Again, CO alarms in the dwelling unit provide a relatively low-cost back-up safety measure.

a10 A-9.34.4.1. Reserved.

A-9.39. Cold Room Slabs.

Design Assumptions

1. Density of Reinforced Concrete = 23.5 kN/m³.
2. Live Loads - As per Sentence 9.4.2.3 (1) of the Building Code, the live load is the lesser of the following:
 - 1.9 kPa,
 - Specified roof snow load, which for Ontario is up to 2.9 kPa.

Therefore a specified design load of 3.0 kPa is appropriate; however, the slab specified is capable of carrying higher live loads since the crack control requirements of CSA A23.3 and cover requirements as given below govern the design of the slab.

3. Design Standards: CSA A23.3-94, “Design of Concrete Structures”.
4. Exposure and Cover for Reinforcing Steel:
 - The slab is considered to be exposed to weather and de-icing chemicals.
 - Minimum top cover is 60 mm as per CSA A23.3 Clause A15.1.7.1 plus a 12 mm tolerance on placement.
 - Minimum bottom cover is 30 mm as per CSA A23.3 Clause A12.6.2 (slab cast against formwork).
 - For 10M reinforcing bars the minimum slab thickness is 72 mm cover + 11.3 mm bar + 11.3 mm bar + 30 mm cover = 125 mm.
5. Design Assumptions:
 - Concrete compressive strength of 32 MPa at 28 days as per Sentence 9.3.1.6.(1) of the Building Code.
 - Reinforcing steel yield strength of 400 Mpa.
 - Slab design is based on a one-way slab simply supported on foundation walls along the edges. Since the slab can be square or rectangular, the same steel is provided in both directions.
 - Maximum span is limited to 20 times the slab thickness as per CSA A23.3 Table 9.1.

A-10 Change of Use.

The successful application of Code requirements to a change of use of an existing building or parts thereof without any proposed construction becomes a matter of balancing the cost of implementing a requirement with the relative importance of that requirement to the overall Code objectives. In general, the degree to which any particular requirement can be relaxed without affecting the intended level of safety of the Code requires considerable judgment on the part of both the designer and the authority having jurisdiction. Therefore, this Part sets out a minimum performance level which the change of use must maintain.

A-11.2.1.1.(1)(a) Construction Index.

The scale of 1 (lowest) to 8 (highest) was formulated for existing buildings, to be used to determine their existing performance level; the numbers, or indices, were established based on the requirements of 3.2.2.20. to 3.2.2.83. Classification of existing buildings will now be in accord with Table 11.2.1.1.A. rather than Subsection 3.2.2. The construction index is established by evaluating all floors and roofs of the existing building.

A-11.2.1.1.(1)(b) Hazard Index.

While the construction index refers to construction of the existing building, hazard index refers to the proposed major occupancy or use of the building; the scales of 1 (lowest hazard) to 8 (highest hazard) are compatible with those of the construction index. In effect, a building with a C.I. of say 3, will support a major occupancy with a H.I. of 3 or lower; if you wish to change to a major occupancy with a H.I. higher than 3, then you must increase the fire protection construction of the building to support that higher hazard according to Table 11.2.1.1.A., or provide the additional upgrading in accordance with Column 4 of Table 11.4.3.4.A.

A-11.3.1.1.(1) Performance Level.

States the philosophy and intent of this Article: “after construction, the performance level of the building may remain the same, or be made better, but may not be made worse”.

This Page
Intentionally Left Blank

A-11.3.1.2.(1) New and Extension of Existing Building System.

Generally, new or extended building systems should follow the Building Code for new construction, and where necessary, may seek some relief through compliance alternatives, alternative measures or match existing.

A-11.3.3.1. Basic Renovation.

The basic renovation is the simplest form of renovation; the work area is limited in size (within a suite or room), and does not involve a decrease in performance level of the building. The limit in size assures that accesses to exits, corridor separations, or other life safety systems are left intact, where less than a full floor area is under renovation.

A-11.3.3.2. Extensive Renovation.

In cases where extensive renovation of the building is proposed, there is generally no reason why the new systems should not comply with new construction requirements; in this case the applicant may seek relief only through “alternative measures”, should a construction difficulty arise that requires such relief. This would apply to the substantial renovation of the entire building.

a2.1 A-11.3.3.2.(3) Application of Limited Barrier-Free Design Requirements in Renovations.

Certain barrier-free design provisions must be incorporated into all renovations where new interior walls or floor assemblies are installed other than in a suite described in Sentence (2) or in a suite in a building described in Sentence 3.8.1.1.(1). This includes construction within suites less than 300 m² and suites on storeys or floor levels not accessible by a barrier-free path of travel. In those cases, any new construction is subject to the barrier-free design provisions listed in 11.3.3.2.(3). Sentence 1.1.2.7.(1) of Division A continues to apply, so that any existing construction that is not being materially altered as part of the renovation need not include barrier-free design features.

The intent of these provisions is to make more suites and buildings accessible for people with sensory and other non-mobility disabilities. Not every person with a disability uses a wheelchair. Many people who use mobility aids such as canes or service animals or who have sensory disabilities are able to navigate stairs but would benefit from certain barrier-free elements such as lever door handles or an ambulatory washroom stall.

A-11.4.3.1. Compensating Construction.

Where the performance level of the building or part of the building is reduced through Subsection 11.4.2., compensating construction will be required to restore the performance level to its former state, of the early warning and evacuation systems, the fire and structural protection construction of the building. The amount of upgrading required depends on the results of a performance level evaluation.

The extent, or areas covered, of this upgrading include the protection of the surrounding existing areas from the portion being renovated, and the means of egress from the building if adversely affected by the renovation.

A-11.4.3.2.(1) Structural.

Provides, subject to any of three conditions, for adequacy of support for floors that will be receiving increased dead or live loads: options are restriction of loads, or upgrading of support systems.

A-11.4.3.3. Increase in Occupant Load.

Where the increase is greater than 15%, and construction takes place, the performance level is reduced and must be restored as required in Table 11.4.3.3.

Where the increase is 15% or less, and construction takes place, the performance level is reduced. Where the new occupant load is more than 15% above the exit capacity or for which a fire alarm system is required. The performance level must be restored as required by Table 11.4.3.3.

Smaller buildings, of 14 persons or less in boarding houses, and 16 persons or less in dwelling units, are exempt.

A-11.4.3.4. Change in Major Occupancy.

Provided construction takes place, a change in major occupancy to one of a greater hazard index reduces the performance level. An increase of the hazard index will trigger the classification of the entire building as to its construction index and hazard index under Table 11.4.3.3., Table 11.4.3.4.A. and B, to determine what upgrading, if any is required to ensure that the building will support that new hazard.

A-11.5.1. Compliance Alternative.

Subsection 11.5.1. allows compliance alternatives to be used, in lieu of certain requirements in other Parts of Division B. Alternatives to requirements in Part 3, 4, 6 or 8 may be used subject to the chief official's satisfaction, while alternatives to Parts 9 and 12 requirements are not subject to this condition.

as A-12.3.1.5.(1) Residential Furnaces.

Where an existing furnace without a brushless direct current motor is replaced in a dwelling unit or house, replacement with a furnace with similar characteristics would provide an acceptable performance level, since the furnace flow rate and ductwork size would be compatible and this alteration to the heating and cooling system would not reduce the performance level.

Explanatory Material for Division C

A-1.2.1.1. Design by Architect or Professional Engineer.

The practice of architecture is regulated by the Architects Act. The practice of professional engineering is regulated by the Professional Engineers Act. Professional design requirements related to the design of buildings are regulated by the Professional Engineers Act and the Architects Act.

Certain foundations, sprinkler protected glazed wall assemblies, shelf and rack storage systems, tent framing and sign structures are required to be designed by a suitably qualified and experienced person. Refer to Article 1.2.2.1. for general review by an Architect or a Professional Engineer of these assemblies and systems.

Refer to the "Use of the Professional Engineer's Seal" published by Professional Engineers Ontario for guidance on the proper use of a Professional Engineer's seal.

A-1.2.2.1. General Review by Architect or Professional Engineer.

In addition to the general review of the construction of buildings described in Table 1.2.2.1. by an Architect or Professional Engineer, Sentences 1.2.2.1.(4) to (9) require general review by an Architect or a Professional Engineer of certain foundations, sprinkler protected glazed wall assemblies, shelf and rack storage systems, tent framing and sign structures. These assemblies and systems are required to be designed by a suitably qualified and experienced person, as detailed in Article 1.2.2.1.

A-1.3.6.1. As Constructed Plans.

The intent of the provision for as constructed plans is to provide the municipality with authority to ask for information that is necessary for the enforcement of the Act and the Building Code. The intent of the provision is not to duplicate the permit approval process and require similar information to be filed upon completion of the project. Similarly, the provision is not intended to require information and documentation beyond those that are normally generated in the building permit approval process.

A-3.2.2.2.(1) Other Designers.

The qualifications for the designer of a public pool located in a building are based on the size and occupancy of the building. An outdoor public pool is a designated structure. The occupancy of an outdoor public pools depends on the major occupancy of the building it serves. In the case where the outdoor public pool is a stand-alone structure with ancillary change facilities, the major occupancy of the pool would be Group A, Division 4 where it is used for social, education, recreational or similar purposes.

Appendix B

Imperial Conversions of Metric Values

Imperial conversions may be determined using the factors listed below.

Conversion Factors		
to Convert	to	Multiply by
°C	°F	1.8 and add 32
g	oz	0.0353
g	lb	0.0022
kg	lb	2.2046
kg/m ²	lb/ft ²	0.20481
kPa	lb/in ²	0.14503
kPa	lb/ft ²	20.885
L	gal (Imp)	0.21997
L	gal (US)	0.26417
L/m ²	gal/ft ² (Imp)	0.02044
L/s*	gal/min (Imp)	13.198
L/s*	gal/min (US)	15.850
L/s**	ft ³ /min	2.1189
L/s•m	cfm/ft	0.64584
L/s•m ²	cfm/ft ²	0.19685
lx	ft-candle	0.09290
mm	in	0.03937
m	ft	3.2808
m ²	ft ²	10.764
m ³	ft ³	35.315
m ³ /h	ft ³ /min	0.58857
m/s	ft/min	196.85
MJ	Btu	947.82
m ² •°C/W (RSI)	ft ² •h•°F/Btu (R)	5.6785
N	lbf	0.22481
ng/Pa•s•m ²	perms	0.01741
W	Btu/h	3.4122
Column 1	2	3

Notes:

* liquid volume flowrate

** air volume flowrate

SI Units and Their Multiples

The SI prefixes used to form names and symbols of decimal multiples and sub-multiples of SI units are:

Prefix	Symbol	Magnitude	Factor
exa	E	1 000 000 000 000 000 000	10^{18}
peta	P	1 000 000 000 000 000	10^{15}
tera	T	1 000 000 000 000	10^{12}
giga ¹	G	1 000 000 000	10^9
mega ¹	M	1 000 000	10^6
kilo ¹	k	1 000	10^3
hecto ²	h	100	10^2
deca ²	da	10	10^1
deci ²	d	0.1	10^{-1}
centi ²	c	0.01	10^{-2}
milli ¹	m	0.001	10^{-3}
micro ¹	μ	0.000 001	10^{-6}
nano ¹	n	0.000 000 001	10^{-9}
pico	p	0.000 000 000 001	10^{-12}
femto	f	0.000 000 000 000 001	10^{-15}
atto	a	0.000 000 000 000 000 001	10^{-18}
Column 1	2	3	4

Notes:

- (1) most frequently used
- (2) avoid if possible

MMAH Supplementary Standard SA-1

Objectives and Functional Statements Attributed to the Acceptable Solutions

January 15, 2019 update

COMMENCEMENT

MMAH Supplementary Standard SA-1 comes into force on the 1st day of January, 2014.

- m1** Ruling of the Minister of Municipal Affairs and Housing (Minister's Ruling) MR-13-S-24 takes effect on the 1st day of January, 2014.
- r3** SA-1 as amended by Ontario Regulation 361/13 comes into force on the 1st day of January, 2014.
- r3.1** SA-1 as amended by Ontario Regulation 361/13 corresponding to Ontario Regulation 361/13 provisions that come into force on the 1st day of January, 2015.
- r4** SA-1 as amended by Ontario Regulation 361/13 corresponding to Ontario Regulation 368/13 provisions that come into force on the 1st day of January, 2015.
- r5** SA-1 as amended by Ontario Regulation 191/14 comes into force on the 1st day of January, 2015.
- r6** SA-1 as amended by Ontario Regulation 139/17 comes into force on the 1st day of July, 2017.
- r6.1** SA-1 as amended by Ontario Regulation 139/17 comes into force on the 1st day of January, 2018.
- m5** Ruling of the Minister of Municipal Affairs (Minister's Ruling) MR-17-S-28 takes effect on the 1st day of January, 2018.
- r11** SA-1 as amended by Ontario Regulation 88/19 comes into force on the 2nd day of May, 2019.
- r11.1** SA-1 as amended by Ontario Regulation 88/19 comes into force on the 1st day of January, 2020.
- r11.2** SA-1 as amended by Ontario Regulation 88/19 comes into force on the 1st day of January, 2022.

EDITORIAL

- e1** Editorial correction issued for January 1st, 2014.
- e2** Editorial correction issued for January 1st, 2014.
- e2.1** Editorial correction issued for January 1st, 2015.
- e3** Editorial correction issued for January 1st, 2015.
- e4** Editorial correction issued for July 1st, 2017.
- e4.1** Editorial correction issued for January 1st, 2018.
- e5** Editorial correction issued for January 1st, 2018.
- e6** Editorial correction issued for May 2nd, 2019.
- e6.1** Editorial correction issued for January 1st, 2020.
- e6.2** Editorial correction issued for January 1st, 2022.
- e7** Editorial correction issued for December 16th, 2020.

© Copyright

© Copyright Queen's Printer for Ontario 2020

All rights reserved.

Questions regarding copyright, including reproduction and distribution, may be directed to the Director,
Building and Development Branch of the Ministry of Municipal Affairs and Housing.

Contents

1.	Scope	3
2.	Objectives and Functional Statements	3
3.	Attribution to Acceptable Solutions	3
Table 3	Objectives and Functional Statements Attributed to the Acceptable Solutions in Part 3 of Division B	4
Table 4	Objectives and Functional Statements Attributed to the Acceptable Solutions in Part 4 of Division B	78
Table 5	Objectives and Functional Statements Attributed to the Acceptable Solutions in Part 5 of Division B	92
Table 6	Objectives and Functional Statements Attributed to the Acceptable Solutions in Part 6 of Division B	97
Table 7	Objectives and Functional Statements Attributed to the Acceptable Solutions in Part 7 of Division B	107
Table 8	Objectives and Functional Statements Attributed to the Acceptable Solutions in Part 8 of Division B	133
Table 9	Objectives and Functional Statements Attributed to the Acceptable Solutions in Part 9 of Division B	143
Table 10	Objectives and Functional Statements Attributed to the Acceptable Solutions in Part 10 of Division B	290
Table 11	Objectives and Functional Statements Attributed to the Acceptable Solutions in Part 11 of Division B	292
Table 12	Objectives and Functional Statements Attributed to the Acceptable Solutions in Part 12 of Division B	303

SA-1 Objectives and Functional Statements Attributed to the Acceptable Solutions

1. Scope

This standard specifies, for the purposes of Article 1.2.1.1. of Division A of the Building Code, the objectives and functional statements that have been attributed to acceptable solutions provided in Division B of the Building Code.

2. Objectives and Functional Statements

The objectives listed in this standard are those set out in Part 2 of Division A of the Building Code.

The functional statements listed in this standard are set out in Part 3 of Division A of the Building Code.

3. Attribution to Acceptable Solutions

For the purposes of compliance with the Building Code, as required in Sentence 1.2.1.1.(2) of Division A of the Building Code, the objectives and functional statements attributed to the acceptable solutions in Division B shall be the objectives and functional statements listed in Tables 3 to 12.

Table 3
Objectives and Functional Statements Attributed to the Acceptable Solutions in Part 3 of Division B

Acceptable Solutions	Objectives and Functional Statements
3.1.1.1.	Scope
(1)	
3.1.1.2.	Radon
(1)	[F40, F50-OH1.1]
3.1.1.3.	Building in Flood Plains
(1)	(a) [F20-OP2.1]
	(a) [F20-OS2.1, OS2.3]
	(a) [F61-OH1.3]
	(b) [F10, F12-OS3.1] [F10, F30-OS3.7]
3.1.2.1.	Classification of Buildings
(1)	
(2)	
3.1.2.2.	Occupancies of the Same Classification
(1)	
3.1.2.3.	Arena Type Buildings
(1)	
3.1.2.4.	Police Stations
(1)	
3.1.2.5.	Group B, Division 3 Occupancies
(1)	
3.1.2.6.	Restaurants
(1)	
3.1.2.7.	Storage of Combustible Fibres
(1)	
3.1.3.1.	Separation of Major Occupancies
(1)	[F03-OP1.2]
	[F03-OS1.2]
rs (2)	
rs (3)	[F03-OP1.2]
	[F03-OS1.2]
rs (4)	[F03-OP1.2]
	[F03-OS1.2]
rs (5)	
3.1.3.2.	Prohibition of Occupancy Combinations
(1)	[F02, F03-OS1.2] [F10-OS1.5]
(2)	[F02, F03-OS1.2] [F10-OS1.5]
(3)	[F41-OH2.1]
(4)	
rs (5)	[F02, F03-OS1.2] [F10-OS1.5]
rs (6)	
3.1.4.1.	Combustible Materials Permitted
(1)	
r11.1 3.1.4.2.	Protection of Foamed Plastics
(1) to (3)	[F01-OP1.1] [F02-OP1.2]
	[F01-OS1.1] [F02-OS1.2]
(4)	
3.1.4.3.	Wires and Cables
(1)	[F02-OP1.2]
	[F02-OS1.2]

Acceptable Solutions	Objectives and Functional Statements
(2)	
(3)	
3.1.4.4.	Nonmetallic Raceways
(1)	
3.1.4.5.	Fire-Retardant Treated Wood
(1)	[F02-OP1.2] [F02-OS1.2]
3.1.4.6.	Heavy Timber Construction Alternative
e3 (1), (2)	
3.1.4.7.	Heavy Timber Construction
e3 (1) to (12)	
r5 3.1.4.8.	Cladding
(1)	[F02, F03-OP3.1]
r5 3.1.4.9.	Combustible Piping
(1)	[F02-OP1.2] [F02-OS1.2]
(2)	
3.1.5.1.	Noncombustible Materials
(1)	[F02-OP1.2] [F02-OS1.2]
(2)	
(3)	
(4)	
3.1.5.2.	Minor Combustible Components
(1)	
3.1.5.3.	Combustible Roofing Materials
(1)	
(2)	
(3)	
(4)	
3.1.5.4.	Combustible Glazing and Skylights
(1)	
(2)	
(3)	
(4)	
(5)	
r11.1 3.1.5.5.	Combustible Components for Exterior Walls
(1)	
(2)	[F02, F03-OP3.1]
(3), (4)	
r11.1 3.1.5.5A.	Factory-Assembled Panels
(1) to (3)	
3.1.5.6.	Nailing Elements
(1)	
3.1.5.7.	Combustible Millwork
(1)	
3.1.5.8.	Combustible Flooring Elements
(1)	
(2)	
(3)	
(4)	

	Acceptable Solutions	Objectives and Functional Statements
	3.1.5.9.	Combustible Stairs in Dwelling Units
	(1)	
R11.1	3.1.5.10.	Combustible Interior Finish
	(1) to (4)	
	3.1.5.11.	Gypsum Board
	(1)	
R11.1	3.1.5.12.	Combustible Insulation
	(1)	
	(2)	
	(3)	
	(4)	
	(5)	
	(6)	
R11.1	3.1.5.12A.	Foam Plastic Insulation
	(1) to (4)	
	3.1.5.13.	Combustible Elements in Partitions
	(1)	
	(2)	
	(3)	
	3.1.5.14.	Storage Lockers in Residential Buildings
	(1)	
	3.1.5.15.	Combustible Ducts
	(1)	
	(2)	
	(3)	
	3.1.5.16.	Combustible Piping Materials
	(1)	
	(2)	
	(3)	
	3.1.5.17.	Combustible Plumbing Fixtures
	(1)	
	3.1.5.18.	Wires and Cables
	(1)	
	(2)	
	3.1.5.19.	Combustible Travelling Cables for Elevators
	(1)	
	3.1.5.20.	Nonmetallic Raceways
	(1)	[F02-OP1.2]
		[F02-OS1.2]
	3.1.5.21.	Wires in Computer Room Floors
	(1)	
	(2)	
	3.1.5.22.	Combustible Components in Public Pools and Public Spas
	(1)	
	3.1.5.23.	Marquees Having Combustible Elements
	(1)	
	(2)	
	3.1.5.24.	Combustible Mezzanines
	(1)	
	3.1.5.25.	Wood Decorative Cladding
	(1)	

Acceptable Solutions	Objectives and Functional Statements
3.1.5.26.	Combustible Solar Collector Systems
(1)	
3.1.7.1.	Determination of Ratings
(1)	[F03-OP1.2] [F04-OP1.3] [F03-OS1.2] [F04-OS1.3]
(2)	
3.1.7.2.	Exception for Exterior Walls
(1)	
3.1.7.3.	Exposure Conditions for Rating
(1)	
(2)	
(3)	
3.1.7.4.	Minimum Fire-Resistance Rating
(1)	
3.1.7.5.	Rating of Supporting Construction
(1)	[F04-OP1.3] [F04-OS1.3]
(2)	
(3)	[F04-OP1.3] [F04-OS1.3]
3.1.8.1.	General Requirements
(1)	(a) [F03-OP1.2] (a) [F03-OS1.2]
(2)	[F03-OP1.2] Applies to the requirement that openings in <i>fire separations</i> be protected with <i>closures</i> , shafts or other means. [F03-OS1.2] Applies to the requirement that openings in <i>fire separations</i> be protected with <i>closures</i> , shafts or other means.
3.1.8.2.	Combustible Construction Support
(1)	[F04-OP1.2] [F04-OS1.2]
3.1.8.3.	Continuity of Fire Separations
(1)	[F03-OP1.2] [F03-OS1.2]
(2)	[F03-OP1.2] [F03-OS1.2]
(3)	(a), (b) [F03-OP1.2] (a), (b) [F03-OS1.2]
(4)	[F03-OP1.2] [F03-OS1.2]
11.1 3.1.8.4.	Determination of Ratings
(1) to (4)	[F03-OP1.2] [F03-OS1.2]
11.1 3.1.8.5.	Installation of Closures
(1)	
(2)	[F03-OP1.2] [F03-OS1.2]
(3)	[F03-OP1.2] [F03-OS1.2]
(4)	[F81-OP1.2] [F81-OS1.2]
(5), (6)	[F03-OP1.2] [F03-OS1.2]
(7)	

Acceptable Solutions	Objectives and Functional Statements
3.1.8.6.	Maximum Openings
(1)	[F03-OP1.2] [F03-OS1.2]
(2)	[F03-OP1.2] [F03-OS1.2]
r11.1	3.1.8.7. Location of Fire Dampers and Smoke Dampers
(1), (2)	[F03-OP1.2] [F03-OS1.2]
r11.1	3.1.8.8. Fire Dampers Waived
(1) to (4)	
r11.1	3.1.8.8A. Smoke Dampers Waived
(1), (2)	
r11.1	3.1.8.9. Installation of Fire Dampers
(1)	[F04-OP1.2] [F04-OS1.2]
(2)	[F03-OP1.2] [F03-OS1.2]
(3)	[F04-OP1.2] [F04-OS1.2]
(4)	[F03-OP1.2] [F03-OS1.2]
r11.1	3.1.8.9A. Installation of Smoke Dampers
(5)	[F82-OH1.2] Applies to portion of code text "A tightly fitted access door shall be installed for each <i>fire damper</i> to provide access for ... the resetting of the release device." [F82-OP1.2] Applies to portion of code text "A tightly fitted access door shall be installed for each <i>fire damper</i> to provide access for the inspection of the damper..." [F82-OS1.2] Applies to portion of code text "A tightly fitted access door shall be installed for each <i>fire damper</i> to provide access for the inspection of the damper..."
r11.1	3.1.8.9A. Installation of Smoke Dampers
(1) to (4)	[F03-OP1.2] [F03-OS1.2]
(5)	[F82-OH1.2] Applies to portion of code text "A tightly fitted access door shall be installed for each <i>fire damper</i> to provide access for ... the resetting of the release device." [F82-OP1.2] Applies to portion of code text "A tightly fitted access door shall be installed for each <i>fire damper</i> to provide access for the inspection of the damper..." [F82-OS1.2] Applies to portion of code text "A tightly fitted access door shall be installed for each <i>fire damper</i> to provide access for the inspection of the damper..."
3.1.8.10.	Twenty-Minute Closures
(1)	
(2)	
(3)	[F03-OP1.2] [F03-OS1.2]
(4)	
3.1.8.11.	Self-Closing Devices
(1)	[F03-OP1.2] [F03-OS1.2]
(2)	
(3)	
(4)	
(5)	
r11.1	3.1.8.12. Hold-Open Devices
(1)	[F03-OS1.2] [F03-OP1.2]
(2)	[F03-OP1.2] [F03-OS1.2]

Acceptable Solutions	Objectives and Functional Statements
(3)	[F03-OP1.2] [F03-OS1.2]
(4)	[F03-OP1.2] [F03-OS1.2]
(5)	[F03-OP1.2] [F03-OS1.2]
(6)	
3.1.8.13.	Door Latches
(1)	[F03-OP1.2] [F03-OS1.2]
3.1.8.14.	Wired Glass and Glass Block
(1)	
(2)	
(3)	[F04-OP1.2] Applies to portion of Code text: "Glass blocks permitted by Sentence (1) shall be ... reinforced with steel reinforcement in each horizontal joint." [F04-OS1.2] Applies to portion of Code text: "Glass blocks permitted by Sentence (1) shall be ... reinforced with steel reinforcement in each horizontal joint."
3.1.8.15.	Temperature Rise Limit for Doors
(1)	[F03-OP1.2] [F03, F31-OS1.2] [F05-OS1.5]
3.1.8.16.	Area Limits for Wired Glass and Glass Block
(1)	[F31-OS1.2] [F05-OS1.5] [F30-OS3.1]
(2)	[F31-OS1.2] [F05-OS1.5]
3.1.8.17.	Temperature Rise and Area Limits Waived
(1)	
3.1.8.18.	Sprinkler Protected Glazed Wall Assembly
(1)	[F03-OP1.2] [F04-OP1.3] [F03-OS1.2] [F04-OS1.3]
(2)	[F03-OP1.2] [F04-OP1.3] [F03-OS1.2] [F04-OS1.3]
(3)	[F03, F06-OS1.2] [F05, F06-OS1.5] [F03, F06-OP1.2]
3.1.9.1.	Fire Stopping of Service Penetrations
(1)	[F03-OP1.2] [F04-OP1.3] [F03-OS1.2] [F04-OS1.3]
(2)	[F03-OP1.2] [F03-OP3.1] [F03-OS1.2]
(3)	(a) [F03-OP1.2] (a) [F03-OS1.2] [F10-OS1.5]
(4)	
(5)	
3.1.9.2.	Combustibility of Service Penetrations
(1)	[F03-OP1.2] [F02, F04-OP1.3] Applies to portion of Code text: "Except as permitted by Articles 3.1.9.3. and 3.1.9.4., pipes, ducts, electrical outlet boxes, totally enclosed raceways or other similar service equipment that penetrate an assembly required to have a <i>fire-resistance rating</i> shall be <i>noncombustible</i> ..." [F03-OS1.2] [F02, F04-OS1.3] Applies to portion of Code text: "Except as permitted by Articles 3.1.9.3. and 3.1.9.4., pipes, ducts, electrical outlet boxes, totally enclosed raceways or other similar service equipment that penetrate an assembly required to have a <i>fire-resistance rating</i> shall be <i>noncombustible</i> ..."
3.1.9.3.	Penetration by Wires, Cables and Outlet Boxes
(1)	

Acceptable Solutions	Objectives and Functional Statements	
(2)		
(3)		
(4)		
(5)		
(6)		
(7)		
e7 F11.1	3.1.9.3A. Penetration by Outlet Boxes	
	(1)	
	[F03-OP1.2]	
	[F03-OS1.2]	
	(2)	
	(3)	[F03-OP1.2]
	[F03-OS1.2]	
	3.1.9.4. Combustible Piping Penetrations	
	(1)	[F03-OP1.2] [F02, F04-OP1.3]
	[F03-OS1.2] [F02, F04-OS1.3]	
	(2)	[F03-OP1.2] [F02, F04-OP1.3]
	[F03-OS1.2] [F02, F04-OS1.3]	
	(3)	
	(4)	
	(5)	
	(6)	
	(7)	[F03-OP1.2] [F02, F04-OP1.3]
	[F03-OS1.2] [F02, F04-OS1.3]	
	(8)	
	3.1.9.5. Openings Through a Membrane Ceiling	
	(1)	[F04-OP1.3]
	[F04-OS1.3]	
	(2)	[F04-OP1.3]
	[F04-OS1.3]	
3.1.9.6. Plenums		
(1)		
3.1.10.1. Prevention of Firewall Collapse		
(1)	[F04-OP1.2]	
[F04-OP3.1]		
[F04-OS1.2]		
(2)	[F03, F04-OP1.2]	
[F03, F04-OP3.1]		
[F03, F04-OS1.2]		
(3)		
(4)	[F04-OP1.2]	
[F04-OP3.1]		
[F04-OS1.2]		
3.1.10.2. Rating of Firewalls		
(1)	[F03-OP1.2] Applies to portion of Code text: "A <i>firewall</i> which separates a <i>building</i> or <i>buildings</i> with <i>floor areas</i> containing a Group E or a Group F, Division 1 or 2 <i>major occupancy</i> shall be constructed as a <i>fire separation of noncombustible construction</i> having a <i>fire-resistance rating</i> not less than 4 h ..."	
[F03-OP3.1] Applies to portion of Code text: "A <i>firewall</i> which separates a <i>building</i> or <i>buildings</i> with <i>floor areas</i> containing a Group E or a Group F, Division 1 or 2 <i>major occupancy</i> shall be constructed as a <i>fire separation of noncombustible construction</i> having a <i>fire-resistance rating</i> not less than 4 h ..."		
[F03-OS1.2] Applies to portion of Code text: "A <i>firewall</i> which separates a <i>building</i> or <i>buildings</i> with <i>floor areas</i> containing a Group E or a Group F, Division 1 or 2 <i>major occupancy</i> shall be constructed as a <i>fire separation of noncombustible construction</i> having a <i>fire-resistance rating</i> not less than 4 h ..."		

Acceptable Solutions	Objectives and Functional Statements
(2)	[F03-OP1.2] [F03-OP3.1] [F03-OS1.2]
(3)	[F80, F04-OP1.2] [F80, F04-OP1.3] [F80, F04-OS1.2]
(4)	[F80, F04-OP1.2] [F80, F04-OP3.1] [F80, F04-OS1.2]
3.1.10.3.	Continuity of Firewalls
(1)	[F03-OP1.2] Applies to portion of Code text: "A <i>firewall</i> shall extend from the ground continuously through, or adjacent to, all <i>storeys</i> of a <i>building</i> or <i>buildings</i> so separated ..." [F03-OP3.1] Applies to portion of Code text: "A <i>firewall</i> shall extend from the ground continuously through, or adjacent to, all <i>storeys</i> of a <i>building</i> or <i>buildings</i> so separated ..." [F03-OS1.2] Applies to portion of Code text: "A <i>firewall</i> shall extend from the ground continuously through, or adjacent to, all <i>storeys</i> of a <i>building</i> or <i>buildings</i> so separated ..."
(2)	
3.1.10.4.	Parapets
(1)	[F03-OP1.2] [F03-OP3.1] [F03-OS1.2]
(2)	
3.1.10.5.	Maximum Openings
(1)	[F03-OP1.2] Applies to portion of Code text: "... the aggregate width of openings shall be not more than 25% of the entire length of the <i>firewall</i> ." [F03-OP3.1] Applies to portion of Code text: "... the aggregate width of openings shall be not more than 25% of the entire length of the <i>firewall</i> ." [F03-OS1.2] Applies to portion of Code text: "... the aggregate width of openings shall be not more than 25% of the entire length of the <i>firewall</i> ."
3.1.10.6.	Exposure Protection for Adjacent Walls
(1)	
3.1.10.7.	Combustible Projections
(1)	[F03-OP1.2] Applies to portion of Code text: " <i>Combustible material</i> shall not extend across the end of a <i>firewall</i> ..." [F03-OP3.1] Applies to portion of Code text: " <i>Combustible material</i> shall not extend across the end of a <i>firewall</i> ..." [F03-OS1.2] Applies to portion of Code text: " <i>Combustible material</i> shall not extend across the end of a <i>firewall</i> ..."
(2)	[F03-OP1.2] [F03-OP3.1] [F03-OS1.2]
3.1.11.1.	Separation of Concealed Spaces
(1)	[F03-OP1.2] [F03-OS1.2]
3.1.11.2.	Fire Blocks in Wall Assemblies
(1)	[F03-OP1.2] [F03-OS1.2]
(2)	
3.1.11.3.	Fire Blocks between Nailing and Supporting Elements
(1)	[F03-OP1.2] [F03-OS1.2]
(2)	[F03-OP1.2] [F03-OS1.2]
3.1.11.4.	Fire Blocks between Vertical and Horizontal Spaces
(1)	[F03-OP1.2] [F03-OS1.2]

Acceptable Solutions	Objectives and Functional Statements
3.1.11.5.	Fire Blocks of Horizontal Concealed Spaces
(1)	[F03, F04-OP1.2] [F03, F04-OS1.2]
(2)	[F03, F04-OP1.2] [F03, F04-OS1.2]
(3)	[F03, F04-OP1.2] [F03, F04-OS1.2]
(4)	
3.1.11.6.	Fire Blocks of Crawl Spaces
(1)	[F03, F04-OP1.2] [F03, F04-OS1.2]
3.1.11.7.	Fire Block Materials
(1)	[F04-OP1.2] [F04-OS1.2]
(2)	
(3)	
(4)	
(5)	[F04-OP1.2] [F04-OS1.2]
(6)	[F03-OP1.2] [F03-OS1.2]
(7)	
3.1.12.1.	Determination of Ratings
(1)	[F02-OP1.2] [F02-OS1.2]
(2)	[F02-OP1.2] [F02-OS1.2]
(3)	
3.1.13.1.	Interior Finish Description
(1)	
3.1.13.2.	Flame-Spread Rating
(1)	[F02-OP1.2] [F02-OS1.2]
(2)	
(3)	
(4)	
(5)	
3.1.13.3.	Plumbing Fixtures and Bathroom Finishes
(1)	
(2)	[F02-OP1.2] [F02-OS1.2]
3.1.13.4.	Light Diffusers and Lenses
(1)	
3.1.13.5.	Skylights
(1)	[F02-OS1.5]
3.1.13.6.	Corridors
(1)	[F02-OS1.2, OS1.5]
(2)	
(3)	
(4)	
(5)	[F02-OS1.2, OS1.5]
(6)	

Acceptable Solutions	Objectives and Functional Statements
3.1.13.7.	High Buildings
(1)	[F02-OP1.2] [F02-OS1.2]
(2)	
(3)	
(4)	[F02-OP1.2] [F02-OS1.2]
(5)	
(6)	
(7)	
3.1.13.8.	Noncombustible Construction
(1)	
3.1.13.9.	Underground Walkways
(1)	[F02-OP3.1] [F02-OS1.2]
3.1.13.10.	Exterior Exit Passageway
(1)	[F02-OS1.5]
3.1.13.11.	Elevator Cars
(1)	[F02-OP1.2] [F02-OS1.2]
(2)	[F02-OP1.2] [F02-OS1.2]
3.1.14.1.	Fire-Retardant Treated Wood Roof Systems
(1)	[F02-OP1.2] [F02-OS1.2]
(2)	[F02-OP1.3] [F02-OS1.2, OS1.3]
3.1.14.2.	Metal Roof Deck Assemblies
(1)	[F02-OP1.2] [F02-OS1.2]
(2)	
3.1.15.1.	Roof Covering Classification
(1)	[F02-OP1.2] [F02-OP3.1] [F02-OS1.2]
3.1.15.2.	Roof Coverings
(1)	[F02-OP1.2] [F02-OP3.1] [F02-OS1.2]
(2)	
(3)	[F02-OP1.2] [F02-OP3.1] [F02-OS1.2]
3.1.16.1.	Fabric Awnings, Canopies and Marquees
(1)	[F02-OP1.2] [F02-OS1.2, OS1.5]
3.1.17.1.	Occupant Load Determination
(1)	[F10-OS3.7] [F72-OH2.1] [F71-OH2.3]
(2)	[F10-OS3.7] [F72-OH2.1] [F71-OH2.3]
(3)	

rs

e5

r11

e3

e6

Acceptable Solutions	Objectives and Functional Statements
(4)	[F10-OS3.7] [F72-OH2.1] [F71-OH2.3]
(5)	[F10-OS3.7] [F72-OH2.1] [F71-OH2.3]
(6), (7)	
3.1.17.2.	Dance Floor
(1)	
3.1.17.3.	Public Pools
(1)	[F10-OS3.7] [F72-OH2.1] [F71-OH2.3]
(2)	[F10-OS3.7] [F72-OH2.1] [F71-OH2.3]
3.1.18.1.	Drainage
(1)	[F60-OH1.1, OH1.2, OH1.3] [F60-OS2.3]
3.1.19.1.	Clearance to Buildings
(1)	[F01-OP1.1] [F01-OS1.1] [F32-OS3.3]
(2)	[F01-OP1.1] [F01-OS1.1] [F32-OS3.3]
(3)	[F01-OP1.1] [F01-OS1.1] [F32-OS3.3]
(4)	
3.1.20.1.	Glass
(1)	[F30-OS2.3, OS3.1]
3.1.21.1.	Revoked
3.2.1.1.	Exceptions in Determining Building Height
(1) to (9)	
3.2.1.2.	Storage Garage Considered as a Separate Building
(1)	[F03-OP1.2] [F03-OS1.2]
(2)	[F03-OP1.2] [F03-OS1.2]
(3)	[F03-OP1.2] [F03-OS1.2]
3.2.1.3.	Roof Considered as a Wall
(1)	
3.2.1.4.	Floor Assembly over Basement
(1)	[F03-OP1.2] [F04-OP1.3] [F03-OS1.2] [F04-OS1.3]
(2)	[F04-OP1.2, OP1.3] [F04-OS1.2, OS1.3]
3.2.1.5.	Fire Containment in Basements
(1)	[F02-OP1.2, OP1.3] [F02-OS1.2, OS1.3]
(2)	
3.2.1.6.	Mezzanines
(1)	

Acceptable Solutions	Objectives and Functional Statements
3.2.2.1.	Application
(1)	
3.2.2.2.	Special and Unusual Structures
(1)	[F02, F03, F04-OP1.2, OP1.3]
	[F02, F03, F04-OS1.2, OS1.3]
3.2.2.3.	Exceptions to Structural Fire Protection
(1)	
3.2.2.4.	Buildings with Multiple Major Occupancies
(1)	
(2)	
r6 (3)	
3.2.2.5.	Applicable Building Height and Area
(1)	
r6 (2)	
3.2.2.6.	Multiple Major Occupancies
(1)	[F02, F03, F04-OP1.2, OP1.3]
	[F02, F03, F04-OS1.2, OS1.3]
r6 (2)	
3.2.2.7.	Superimposed Major Occupancies
(1)	
(2)	
r6 (3)	
3.2.2.8.	Exceptions for Major Occupancies
(1)	
r6 (1.1)	
(2)	
3.2.2.9.	Crawl Spaces
(1)	
(2)	
r5 3.2.2.10.	Streets
(1)	[F12-OP1.2]
	[F12-OS1.2, OS1.5]
e4 (2) to (6)	
3.2.2.11.	Exterior Balconies
(1)	
3.2.2.12.	Exterior Passageways
(1)	
3.2.2.13.	Occupancy on Roof
(1)	
3.2.2.14.	Roof-Top Enclosures
(1)	
(2)	
(3)	
(4)	
3.2.2.15.	Storeys Below Ground
(1)	
(2)	(a) [F02, F04-OP1.2, OP1.3]
	(a) [F02, F04-OS1.2, OS1.3]
	(b), (c) [F03, F04-OP1.2] [F04-OP1.3]
	(b), (c) [F03, F04-OS1.2] [F04-OS1.3]
(3)	

Acceptable Solutions	Objectives and Functional Statements
3.2.2.16.	Heavy Timber Roof Permitted
(1), (2)	
3.2.2.17.	Sprinklers in Lieu of Roof Rating
(1)	
(2)	
3.2.2.18.	Automatic Sprinkler System Required
(1)	
3.2.2.19.	Buildings Containing Impeded Egress Zones
(1)	
3.2.2.20.	Group A, Division 1, Any Height, Any Area, Sprinklered
(1)	
(2)	<p>[F02-OP1.2] Applies to portion of Code text: "... the <i>building</i> referred to in Sentence (1) shall be of <i>non-combustible construction</i>..."</p> <p>[F02, F04-OP1.2, OP1.3] Applies to portion of Code text: "a) ... the <i>building</i> shall be <i>sprinklered</i>,"</p> <p>[F02-OS1.2] Applies to portion of Code text: "... the <i>building</i> referred to in Sentence (1) shall be of <i>non-combustible construction</i>..."</p> <p>[F02, F04-OS1.2, OS1.3] Applies to portion of Code text: "a) ... the <i>building</i> shall be <i>sprinklered</i>,"</p> <p>(b), (d) [F03, F04-OP1.2] [F04-OP1.3]</p> <p>(b), (d) [F03, F04-OS1.2] [F04-OS1.3]</p> <p>(c) [F04-OP1.3]</p> <p>(c) [F04-OS1.3]</p>
3.2.2.21.	Group A, Division 1, One Storey, Limited Area
(1)	
(2)	<p>[F02-OP1.2] Applies to portion of Code text: "The <i>building</i> referred to in Sentence (1) is permitted to be of <i>heavy timber construction</i> or <i>noncombustible construction</i> used singly or in combination,"</p> <p>[F03, F04-OP1.2] [F04-OP1.3] Applies to portion of Code text: "a) floor assemblies shall be <i>fire separations</i>, i) with a <i>fire-resistance rating</i> not less than 45 min," and to Clause (b).</p> <p>[F02-OS1.2] Applies to portion of Code text: "The <i>building</i> referred to in Sentence (1) is permitted to be of <i>heavy timber construction</i> or <i>noncombustible construction</i> used singly or in combination"</p> <p>[F03, F04-OS1.2] [F04-OS1.3] Applies to portion of Code text: "a) floor assemblies shall be <i>fire separations</i>, i) with a <i>fire-resistance rating</i> not less than 45 min," and to Clause (b).</p>
3.2.2.22.	Group A, Division 1, One Storey
(1)	
(2)	<p>[F03, F04-OP1.2] [F04-OP1.3] Applies to portion of Code text: "a) floor assemblies shall be <i>fire separations</i> with a <i>fire-resistance rating</i> not less than 45 min," and to Clause (d).</p> <p>[F03, F04-OS1.2] [F04-OS1.3] Applies to portion of Code text: "a) floor assemblies shall be <i>fire separations</i> with a <i>fire-resistance rating</i> not less than 45 min," and to Clause (d).</p> <p>(b), (c) [F04-OP1.3]</p> <p>(b), (c) [F04-OS1.3]</p>
3.2.2.23.	Group A, Division 2, Any Height, Any Area, Sprinklered
(1)	
(2)	<p>[F02-OP1.2] Applies to portion of Code text: "... the <i>building</i> referred to in Sentence (1) shall be of <i>noncombustible construction</i> ..."</p> <p>[F02, F04-OP1.2, OP1.3] Applies to portion of Code text: "a) ... the <i>building</i> shall be <i>sprinklered</i>,"</p> <p>[F02-OS1.2] Applies to portion of Code text: "... the <i>building</i> referred to in Sentence (1) shall be of <i>noncombustible construction</i> ..."</p> <p>[F02, F04-OS1.2, OS1.3] Applies to portion of Code text: "a) ... the <i>building</i> shall be <i>sprinklered</i>,"</p> <p>(b), (d) [F03, F04-OP1.2] [F04-OP1.3]</p> <p>(b), (d) [F03, F04-OS1.2] [F04-OS1.3]</p> <p>(c) [F04-OP1.3]</p> <p>(c) [F04-OS1.3]</p>
3.2.2.24.	Group A, Division 2, up to 6 Storeys, Any Area, Sprinklered
(1)	<p>[F02, F04-OP1.2, OP1.3] Applies to portion of Code text: "a)... the <i>building</i> is <i>sprinklered</i>,"</p> <p>[F02, F04-OS1.2, OS1.3] Applies to portion of Code text: "a)... the <i>building</i> is <i>sprinklered</i>,"</p>

Acceptable Solutions	Objectives and Functional Statements
(2)	[F02-OP1.2] Applies to portion of Code text: "... the <i>building</i> referred to in Sentence (1) shall be of <i>noncombustible construction</i> ," [F02-OS1.2] Applies to portion of Code text: "... the <i>building</i> referred to in Sentence (1) shall be of <i>noncombustible construction</i> ," (a), (c) [F03, F04-OP1.2] [F04-OP1.3] (a), (c) [F03, F04-OS1.2] [F04-OS1.3] (b) [F04-OP1.3] (b) [F04-OS1.3]
3.2.2.25.	Group A, Division 2, up to 2 Storeys
(1)	
(2)	[F04-OP1.3] Applies to portion of Code text: "c) roof assemblies shall have, if of <i>combustible construction</i> , a <i>fire-resistance rating</i> not less than 45 min," and to Clause (d). [F04-OS1.3] Applies to portion of Code text: "c) roof assemblies shall have, if of <i>combustible construction</i> , a <i>fire-resistance rating</i> not less than 45 min," and to Clause (d). (a) [F03-OP1.2] Applies to the requirement that <i>noncombustible</i> floor assemblies be <i>fire separations</i> . (a) [F03-OS1.2] Applies to the requirement that <i>noncombustible</i> floor assemblies be <i>fire separations</i> . (a), (d) [F03, F04-OP1.2] [F04-OP1.3] (a), (d) [F03, F04-OS1.2] [F04-OS1.3] (b) [F04-OP1.3] (b) [F04-OS1.3]
3.2.2.26.	Group A, Division 2, up to 2 Storeys, Increased Area, Sprinklered
(1)	[F02, F04-OP1.2, OP1.3] Applies to portion of Code text: "a)... the <i>building</i> is <i>sprinklered</i> ," [F02, F04-OS1.2, OS1.3] Applies to portion of Code text: "a)... the <i>building</i> is <i>sprinklered</i> ,"
(2)	(a) [F03-OP1.2] Applies to the requirement that <i>noncombustible</i> floor assemblies be <i>fire separations</i> . (a) [F03-OS1.2] Applies to the requirement that <i>noncombustible</i> floor assemblies be <i>fire separations</i> . (a), (c) [F03, F04-OP1.2] [F04-OP1.3] (a), (c) [F03, F04-OS1.2] [F04-OS1.3] (b) [F04-OP1.3] (b) [F04-OS1.3]
3.2.2.27.	Group A, Division 2, up to 2 Storeys, Sprinklered
(1)	[F02, F04-OP1.2, OP1.3] Applies to portion of Code text: " a) the <i>building</i> is <i>sprinklered</i> ," [F02, F04-OS1.2, OS1.3] Applies to portion of Code text: " a) the <i>building</i> is <i>sprinklered</i> ,"
3.2.2.28.	Group A, Division 2, One Storey
(1)	
(2)	[F03-OP1.2] [F03-OS1.2]
3.2.2.29.	Group A, Division 3, Any Height, Any Area
(1)	
(2)	[F02-OP1.2] Applies to portion of Code text: "... the <i>building</i> referred to in Sentence (1) shall be of <i>noncombustible construction</i> ..." [F02, F04-OP1.2, OP1.3] Applies to portion of Code text: "a) ... the <i>building</i> shall be <i>sprinklered</i> if..." [F02-OS1.2] Applies to portion of Code text: "... the <i>building</i> referred to in Sentence (1) shall be of <i>noncombustible construction</i> ..." [F02, F04-OS1.2, OS1.3] Applies to portion of Code text: "a) ... the <i>building</i> shall be <i>sprinklered</i> if..." (b), (e) [F03, F04-OP1.2] [F04-OP1.3] (b), (e) [F03, F04-OS1.2] [F04-OS1.3] (c) [F04-OP1.3] (c) [F04-OS1.3]
(3)	[F02-OP1.2] [F04-OP1.3] [F02-OS1.2] [F04-OS1.3]
3.2.2.30.	Group A, Division 3, up to 2 Storeys
(1)	

Acceptable Solutions	Objectives and Functional Statements
(2)	[F02-OP1.2] Applies to portion of Code text: "Except as permitted by Clauses (c) and (d), the <i>building</i> referred to in Sentence (1) shall be of <i>noncombustible construction</i> ," [F04-OP1.3] Applies to portion of Code text: "c) roof assemblies shall i) have a <i>fire-resistance rating</i> not less than 45 min," and to Clause (d). [F02-OS1.2] Applies to portion of Code text: "Except as permitted by Clauses (c) and (d), the <i>building</i> referred to in Sentence (1) shall be of <i>noncombustible construction</i> ," [F04-OS1.3] Applies to portion of Code text: "c) roof assemblies shall i) have a <i>fire-resistance rating</i> not less than 45 min," and to Clause (d). (a), (d) [F03, F04-OP1.2] [F04-OP1.3] (a), (d) [F03, F04-OS1.2] [F04-OS1.3] (b) [F04-OP1.3] (b) [F04-OS1.3]
(3)	[F02-OP1.2] [F04-OP1.3] [F02-OS1.2] [F04-OS1.3]
3.2.2.31.	Group A, Division 3, up to 2 Storeys, Sprinklered
(1)	[F02, F04-OP1.2, OP1.3] Applies to portion of Code text: "a) ... the <i>building</i> shall be <i>sprinklered</i> ," [F02, F04-OS1.2, OS1.3] Applies to portion of Code text: "a) ...the <i>building</i> shall be <i>sprinklered</i> ,"
(2)	[F02-OP1.2] Applies to portion of Code text: "Except as permitted by Clause (c) ... the <i>building</i> referred to in Sentence (1) shall be of <i>noncombustible construction</i> ," [F02-OS1.2] Applies to portion of Code text: "Except as permitted by Clause (c) ... the <i>building</i> referred to in Sentence (1) shall be of <i>noncombustible construction</i> ," (a), (c) [F03-OP1.2] [F04-OP1.2, OP1.3] (a), (c) [F03-OS1.2] [F04-OS1.2, OS1.3] (b) [F04-OP1.3] (b) [F04-OS1.3]
3.2.2.32.	Group A, Division 3, One Storey, Increased Area
(1)	
(2)	[F04-OP1.3] Applies to portion of Code text: " b) roof assemblies shall have, if of <i>combustible construction</i> , a <i>fire-resistance rating</i> not less than 45 min," and to Clause (c). [F04-OS1.3] Applies to portion of Code text: "b) roof assemblies shall have, if of <i>combustible construction</i> , a <i>fire-resistance rating</i> not less than 45 min," and to Clause (c). (a), (c) [F04-OP1.3] (a), (c) [F04-OS1.3]
(3)	[F02-OP1.2] [F04-OP1.3] [F02-OS1.2] [F04-OS1.3]
3.2.2.33.	Group A, Division 3, One Storey, Sprinklered
(1)	[F02, F04-OP1.2, OP1.3] Applies to portion of Code text: "a) ...the <i>building</i> is <i>sprinklered</i> ," [F02, F04-OS1.2, OS1.3] Applies to portion of Code text: "a) ...the <i>building</i> is <i>sprinklered</i> ,"
3.2.2.34.	Group A, Division 3, One Storey
(1)	
3.2.2.35.	Group A, Division 4
(1)	[F02-OP1.2] Applies to portion of Code text: "a <i>building</i> classified as Group A, Division 4 shall be of <i>noncombustible construction</i> ." [F02-OS1.2] Applies to portion of Code text: "a <i>building</i> classified as Group A, Division 4 shall be of <i>noncombustible construction</i> ."
(2)	
(3)	
(4)	[F02, F04-OP1.2, OP1.3] [F02, F04-OS1.2, OS1.3]
3.2.2.36.	Group B, Division 1, Any Height, Any Area, Sprinklered
(1)	
(2)	[F02-OP1.2] Applies to portion of Code text: "... the <i>building</i> referred to in Sentence (1) shall be of <i>noncombustible construction</i> ..." [F02, F04-OP1.2, OP1.3] Applies to portion of Code text: "a) ... the <i>building</i> shall be <i>sprinklered</i> ,"

Acceptable Solutions	Objectives and Functional Statements
(2) (Cont'd)	[F02-OS1.2] Applies to portion of Code text: "... the <i>building</i> referred to in Sentence (1) shall be of <i>noncombustible construction</i> ..." [F02, F04-OS1.2, OS1.3] Applies to portion of Code text: "a) ... the <i>building</i> shall be <i>sprinklered</i> ," (b), (d) [F03, F04-OP1.2] [F04-OP1.3] (b), (d) [F03, F04-OS1.2] [F04-OS1.3] (c) [F04-OP1.3] (c) [F04-OS1.3]
3.2.2.37.	Group B, Division 1, up to 3 Storeys, Sprinklered
(1)	[F02, F04-OP1.2, OP1.3] Applies to portion of Code text: "a) ... the <i>building</i> is <i>sprinklered</i> ," [F02, F04-OS1.2, OS1.3] Applies to portion of Code text: "a) ... the <i>building</i> is <i>sprinklered</i> ,"
(2)	[F02-OP1.2] Applies to portion of Code text: "... the <i>building</i> referred to in Sentence (1) shall be of <i>noncombustible construction</i> ..." [F02-OS1.2] Applies to portion of Code text: "... the <i>building</i> referred to in Sentence (1) shall be of <i>noncombustible construction</i> ..." (a), (c) [F03, F04-OP1.2] [F04-OP1.3] (a), (c) [F03, F04-OS1.2] [F04-OS1.3] (b) [F04-OP1.3] (b) [F04-OS1.3]
3.2.2.38.	Group B, Division 2 or Division 3, Any Height, Any Area, Sprinklered
(1)	
(2)	[F02-OP1.2] Applies to portion of Code text: "... the <i>building</i> referred to in Sentence (1) shall be of <i>noncombustible construction</i> ." [F02, F04-OP1.2, OP1.3] Applies to portion of Code text: "a) ... the <i>building</i> shall be <i>sprinklered</i> ," [F02-OS1.2] Applies to portion of Code text: "... the <i>building</i> referred to in Sentence (1) shall be of <i>noncombustible construction</i> ." [F02, F04-OS1.2, OS1.3] Applies to portion of Code text: "a) ... the <i>building</i> shall be <i>sprinklered</i> ," (b), (d) [F03, F04-OP1.2] [F04-OP1.3] (b), (d) [F03, F04-OS1.2] [F04-OS1.3] (c) [F04-OP1.3] (c) [F04-OS1.3]
3.2.2.39.	Group B, Division 2 or Division 3, up to 3 Storeys, Sprinklered
(1)	[F02, F04-OP1.2, OP1.3] Applies to portion of Code text: "a) ... the <i>building</i> is <i>sprinklered</i> ," [F02, F04-OS1.2, OS1.3] Applies to portion of Code text: "a) ... the <i>building</i> is <i>sprinklered</i> ,"
(2)	[F02-OP1.2] Applies to portion of Code text: "... the <i>building</i> referred to in Sentence (1) shall be of <i>noncombustible construction</i> ." [F02-OS1.2] Applies to portion of Code text: "... the <i>building</i> referred to in Sentence (1) shall be of <i>noncombustible construction</i> ." (a), (c) [F03, F04-OP1.2] [F04-OP1.3] (a), (c) [F03, F04-OS1.2] [F04-OS1.3] (b) [F04-OP1.3] (b) [F04-OS1.3]
3.2.2.40.	Group B, Division 2 or Division 3, up to 2 Storeys, Sprinklered
(1)	[F02, F04-OS1.2, OS1.3] Applies to portion of Code text: "a) ... the <i>building</i> is <i>sprinklered</i> ," [F02, F04-OP1.2, OP1.3] Applies to portion of Code text: "a) ... the <i>building</i> is <i>sprinklered</i> ,"
(2)	(a), (c) [F03, F04-OP1.2] [F04-OP1.3] (a), (c) [F03, F04-OS1.2] [F04-OS1.3] (b) [F04-OP1.3] (b) [F04-OS1.3]
3.2.2.41.	Group B, Division 2 or Division 3, One Storey, Sprinklered
(1)	[F02, F04-OP1.2, OP1.3] Applies to portion of Code text: "a) ... the <i>building</i> is <i>sprinklered</i> ," [F02, F04-OS1.2, OS1.3] Applies to portion of Code text: "a) ... the <i>building</i> is <i>sprinklered</i> ,"
3.2.2.42.	Group C, Any Height, Any Area, Sprinklered
(1)	

Acceptable Solutions	Objectives and Functional Statements
(2)	[F02-OP1.2] Applies to portion of Code text: "...the <i>building</i> referred to in Sentence (1) shall be of <i>noncombustible construction</i> ," [F02-OS1.2] Applies to portion of Code text: "...the <i>building</i> referred to in Sentence (1) shall be of <i>noncombustible construction</i> ," [F02,F04-OP1.2, OP1.3] Applies to portion of Code text: "...a) ...the <i>building</i> shall be <i>sprinklered</i> ..." [F02,F04-OS1.2, OP1.3] Applies to portion of Code text: "...a) ...the <i>building</i> shall be <i>sprinklered</i> ..." (b), (d) [F03-OP1.2] [F04-OP1.2, OP1.3] (b), (d) [F03-OS1.2] [F04-OS1.2, OS1.3] (c), (d) [F04-OP1.3] (c), (d) [F04-OS1.3]
(3)	
r5 3.2.2.43.	Group C, up to 6 Storeys, Sprinklered, Noncombustible Construction
(1)	[F02,F04-OP1.2, OP1.3] Applies to portion of Code text: "...a) ...the <i>building</i> shall be <i>sprinklered</i> ..." [F02,F04-OS1.2,OP1.3] Applies to portion of Code text: "...a) ...the <i>building</i> shall be <i>sprinklered</i> ..."
(2)	[F02-OP1.2] Applies to portion of Code text: "...the <i>building</i> referred to in Sentence (1) shall be of <i>noncombustible construction</i> ," [F02-OS1.2] Applies to portion of Code text: "...the <i>building</i> referred to in Sentence (1) shall be of <i>noncombustible construction</i> ," (a), (c) [F03-OP1.2] [F04-OP1.2, OP1.3] (a), (c) [F03-OS1.2] [F04-OS1.2, OS1.3] (b), (c) [F04-OP1.3] (b), (c) [F04-OS1.3]
(3)	
r5 3.2.2.43A.	Group C, up to 6 Storeys, Sprinklered, Combustible Construction
(1)	[F02,F04-OP1.2, OP1.3] Applies to portion of Code text: "...a) ...the <i>building</i> shall be <i>sprinklered</i> ..." [F02,F04-OS1.2,OP1.3] Applies to portion of Code text: "...a) ...the <i>building</i> shall be <i>sprinklered</i> ..."
(2)	[F03, F04-OP1.2] [F04-OP1.3] Applies to portion of Code text: "a) ... floor assemblies shall be <i>fire separations</i> with a <i>fire-resistance rating</i> not less than 1 h," and to Clause (f). [F03, F04-OS1.2] [F04-OS1.3] Applies to portion of Code text: "a) ... floor assemblies shall be <i>fire separations</i> with a <i>fire-resistance rating</i> not less than 1 h," and to Clause (f). (b), (c), (d), (f) [F04-OP1.3] (b), (c), (d), (f) [F04-OS1.3] (a), (f) [F03-OP1.2] [F04-OP1.2, OP1.3] (a), (f) [F03-OS1.2] [F04-OS1.2, OS1.3] (e) [F03, F06-OS1.2] [F05, F06-OS1.5] (e) [F03, F06-OP1.2]
(3)	
(4)	
(5)	[F02, F03-OS1.2] [F10-OS1.5]
r6 3.2.2.44.	Group C, up to 4 Storeys, Noncombustible Construction
(1)	
(2)	[F02-OP1.2] Applies to portion of Code text: "...the <i>building</i> referred to in Sentence (1) shall be of <i>noncombustible construction</i> ," [F02-OS1.2] Applies to portion of Code text: "...the <i>building</i> referred to in Sentence (1) shall be of <i>noncombustible construction</i> ," [F03, F04-OP1.2] [F04-OP1.3] Applies to portion of Code text: "a) ... floor assemblies shall be <i>fire separations</i> with a <i>fire-resistance rating</i> not less than 1 h," and to Clause (d). [F03, F04-OS1.2] [F04-OS1.3] Applies to portion of Code text: "a) ... floor assemblies shall be <i>fire separations</i> with a <i>fire-resistance rating</i> not less than 1 h," and to Clause (d). (b), (d) [F04-OP1.3] (b), (d) [F04-OS1.3] (c), (d) [F04-OP1.3] (c), (d) [F04-OS1.3]

Acceptable Solutions	Objectives and Functional Statements
(3)	
(4)	
3.2.2.45.	Group C, up to 4 Storeys, Sprinklered
(1)	[F02, F04-OP1.2, OP1.3] Applies to portion of Code text: " a)... the <i>building</i> is <i>sprinklered</i> ," [F02, F04-OS1.2, OS1.3] Applies to portion of Code text: " a)... the <i>building</i> is <i>sprinklered</i> ,"
(2)	[F03, F04-OP1.2] [F04-OP1.3] Applies to portion of Code text: "a) ... floor assemblies shall be <i>fire separations</i> with a <i>fire-resistance rating</i> not less than 1 h," and to Clause (c). [F03, F04-OS1.2] [F04-OS1.3] Applies to portion of Code text: "a) ... floor assemblies shall be <i>fire separations</i> with a <i>fire-resistance rating</i> not less than 1 h," and to Clause (c). (b), (c) [F04-OP1.3] (b), (c) [F04-OS1.3]
(3)	
(4)	
R6	3.2.2.46. Group C, up to 3 Storeys, Increased Area
(1)	
(2)	[F03, F04-OP1.2] [F04-OP1.3] Applies to portion of Code text: " a) ... floor assemblies shall be <i>fire separations</i> with a <i>fire-resistance rating</i> not less than 1 h," and to Clause (d). [F03, F04-OS1.2] [F04-OS1.3] Applies to portion of Code text: " a) ... floor assemblies shall be <i>fire separations</i> with a <i>fire-resistance rating</i> not less than 1 h," and to Clause (d). (b), (c), (d) [F04-OP1.3] (b), (c), (d) [F04-OS1.3]
(3)	
(4)	
R6	3.2.2.47. Group C, up to 3 Storeys
(1)	
(2)	[F03, F04-OP1.2] [F04-OP1.3] Applies to portion of Code text: "a)... floor assemblies shall be <i>fire separations</i> with a <i>fire-resistance rating</i> not less than 45 min," and to Clause (c). [F03, F04-OS1.2] [F04-OS1.3] Applies to portion of Code text: "a) ... floor assemblies shall be <i>fire separations</i> with a <i>fire-resistance rating</i> not less than 45 min," and to Clause (c). (b), (c) [F04-OP1.3] (b), (c) [F04-OS1.3]
(3)	
(4)	
3.2.2.48.	Group C, up to 3 Storeys, Sprinklered
(1)	[F02, F04-OP1.2, OP1.3] Applies to portion of Code text: " a)... the <i>building</i> is <i>sprinklered</i> ," [F02, F04-OS1.2, OS1.3] Applies to portion of Code text: " a)... the <i>building</i> is <i>sprinklered</i> ," [F03, F04-OS1.2] [F04-OS1.3] Applies to portion of Code text: "a) ... floor assemblies shall be <i>fire separations</i> with a <i>fire-resistance rating</i> not less than 45 min," and to Clause (c). (b), (c) [F04-OP1.3] (b), (c) [F04-OS1.3]
(3)	
(4)	
R6	3.2.2.48A. Group C, Retirement Home, Any Height, Any Area, Sprinklered
(1)	
(2)	[F02-OP1.2] Applies to portion of Code text: "... the <i>building</i> referred to in Sentence (1) shall be of <i>noncombustible construction</i> ," [F02, F04-OP1.2, OP1.3] Applies to portion of Code text: " a)... the <i>building</i> shall be <i>sprinklered</i> ..." [F02-OS1.2] Applies to portion of Code text: "... the <i>building</i> referred to in Sentence (1) shall be of <i>noncombustible construction</i> ," [F02, F04-OS1.2, OS1.3] Applies to portion of Code text: " a)... the <i>building</i> shall be <i>sprinklered</i> ..."

Acceptable Solutions	Objectives and Functional Statements
	<p>[F03, F04-OP1.2] [F04-OP1.3] Applies to portion of Code text: "b)... floor assemblies shall be <i>fire separations</i> with a <i>fire-resistance rating</i> not less than 2 h," and to Clause (d).</p> <p>[F03, F04-OS1.2] [F04-OS1.3] Applies to portion of Code text: "b) ... floor assemblies shall be <i>fire separations</i> with a <i>fire-resistance rating</i> not less than 2 h," and to Clause (d).</p> <p>(c), (d) [F04-OP1.3]</p> <p>(c), (d) [F04-OS1.3]</p>
r6	3.2.2.48B. Group C, Retirement Home, up to 4 Storeys, Sprinklered, Increased Area
(1)	<p>[F02, F04-OP1.2, OP1.3] Applies to portion of Code text: " a)... the <i>building is sprinklered</i>,"</p> <p>[F02, F04-OS1.2, OS1.3] Applies to portion of Code text: " a)... the <i>building is sprinklered</i>,"</p>
(2)	<p>[F03, F04-OP1.2] [F04-OP1.3] Applies to portion of Code text: "a)... floor assemblies shall be <i>fire separations</i> with a <i>fire-resistance rating</i> not less than 2 h," and to Clause (c).</p> <p>[F03, F04-OS1.2] [F04-OS1.3] Applies to portion of Code text: "a) ... floor assemblies shall be <i>fire separations</i> with a <i>fire-resistance rating</i> not less than 2 h," and to Clause (c).</p> <p>(b), (c) [F04-OP1.3]</p> <p>(b), (c) [F04-OS1.3]</p>
r6	3.2.2.48C. Group C, Retirement Home, up to 4 Storeys, Sprinklered
(1)	<p>[F02, F04-OP1.2, OP1.3] Applies to portion of Code text: " a)... the <i>building is sprinklered</i>,"</p> <p>[F02, F04-OS1.2, OS1.3] Applies to portion of Code text: " a)... the <i>building is sprinklered</i>,"</p>
(2)	<p>[F03, F04-OP1.2] [F04-OP1.3] Applies to portion of Code text: "a)... floor assemblies shall be <i>fire separations</i> with a <i>fire-resistance rating</i> not less than 1 h," and to Clause (c).</p> <p>[F03, F04-OS1.2] [F04-OS1.3] Applies to portion of Code text: "a) ... floor assemblies shall be <i>fire separations</i> with a <i>fire-resistance rating</i> not less than 1 h," and to Clause (c).</p> <p>(b), (c) [F04-OP1.3]</p> <p>(b), (c) [F04-OS1.3]</p>
r6	3.2.2.48D. Group C, Retirement Home, up to 3 Storeys, Sprinklered, Noncombustible Construction
(1)	<p>[F02, F04-OP1.2, OP1.3] Applies to portion of Code text: " a)... the <i>building is sprinklered</i>,"</p> <p>[F02, F04-OS1.2, OS1.3] Applies to portion of Code text: " a)... the <i>building is sprinklered</i>,"</p>
(2)	<p>[F02-OP1.2] Applies to portion of Code text: "... the <i>building</i> referred to in Sentence (1) shall be of <i>noncombustible construction</i>,"</p> <p>[F02-OS1.2] Applies to portion of Code text: "... the <i>building</i> referred to in Sentence (1) shall be of <i>noncombustible construction</i>,"</p> <p>[F03, F04-OP1.2] [F04-OP1.3] Applies to portion of Code text: "a)... floor assemblies shall be <i>fire separations</i> with a <i>fire-resistance rating</i> not less than 1 h," and to Clause (c).</p> <p>[F03, F04-OS1.2] [F04-OS1.3] Applies to portion of Code text: "a) ... floor assemblies shall be <i>fire separations</i> with a <i>fire-resistance rating</i> not less than 1 h," and to Clause (c).</p> <p>(b), (c) [F04-OP1.3]</p> <p>(b), (c) [F04-OS1.3]</p>
r6	3.2.2.48E. Group C, Retirement Home, up to 3 Storeys, Sprinklered, Combustible Construction
(1)	<p>[F02, F04-OP1.2, OP1.3] Applies to portion of Code text: " a)... the <i>building is sprinklered</i>,"</p> <p>[F02, F04-OS1.2, OS1.3] Applies to portion of Code text: " a)... the <i>building is sprinklered</i>,"</p>
(2)	<p>[F02-OP1.2] Applies to portion of Code text: "... the <i>building</i> referred to in Sentence (1) is permitted or <i>noncombustible construction</i>,"</p> <p>[F02-OS1.2] Applies to portion of Code text: "... the <i>building</i> referred to in Sentence (1) is permitted... or <i>noncombustible construction</i>,"</p> <p>[F03, F04-OP1.2] [F04-OP1.3] Applies to portion of Code text: "a)... floor assemblies shall be <i>fire separations</i> with a <i>fire-resistance rating</i> not less than 1 h," and to Clause (c).</p> <p>[F03, F04-OS1.2] [F04-OS1.3] Applies to portion of Code text: "a) ... floor assemblies shall be <i>fire separations</i> with a <i>fire-resistance rating</i> not less than 1 h," and to Clause (c).</p> <p>(b), (c) [F04-OP1.3]</p> <p>(b), (c) [F04-OS1.3]</p>

Acceptable Solutions	Objectives and Functional Statements
3.2.2.49.	Group D, Any Height, Any Area
(1)	
(2)	[F02-OP1.2] Applies to portion of Code text: "... the <i>building</i> referred to in Sentence (1) shall be of <i>noncombustible construction</i> ," [F02, F04-OP1.2, OP1.3] Applies to portion of Code text: " a)... the <i>building</i> shall be <i>sprinklered</i> ..." [F02-OS1.2] Applies to portion of Code text: "... the <i>building</i> referred to in Sentence (1) shall be of <i>noncombustible construction</i> ," [F02, F04-OS1.2, OS1.3] Applies to portion of Code text: " a)... the <i>building</i> shall be <i>sprinklered</i> ..." (b), (d) [F03, F04-OP1.2] [F04-OP1.3] (b), (d) [F03, F04-OS1.2] [F04-OS1.3] (c) [F04-OP1.3] (c) [F04-OS1.3]
3.2.2.50.	Group D, up to 6 Storeys
(1)	
(2)	[F02-OP1.2] Applies to portion of Code text: "The <i>building</i> referred to in Sentence (1) shall be of <i>noncombustible construction</i> ," [F04-OP1.3] Applies to portion of Code text: "c) roof assemblies shall have a <i>fire-resistance rating</i> not less than 1 h," and to Clause (d). [F02-OS1.2] Applies to portion of Code text: "The <i>building</i> referred to in Sentence (1) shall be of <i>noncombustible construction</i> ," [F04-OS1.3] Applies to portion of Code text: "c) roof assemblies shall have a <i>fire-resistance rating</i> not less than 1 h," and to Clause (d). (a), (d) [F03, F04-OP1.2] [F04-OP1.3] (a), (d) [F03, F04-OS1.2] [F04-OS1.3] (b) [F04-OP1.3] (b) [F04-OS1.3]
rs	3.2.2.50A. Group D, up to 6 Storeys, Sprinklered
(1)	[F02,F04-OP1.2, OP1.3] Applies to portion of Code text: "...a) ...the <i>building</i> shall be <i>sprinklered</i> ..." [F02,F04-OS1.2,OP1.3] Applies to portion of Code text: "...a) ...the <i>building</i> shall be <i>sprinklered</i> ..."
(2)	[F03, F04-OP1.2] [F04-OP1.3] Applies to portion of Code text: "a) ... floor assemblies shall be <i>fire separations</i> with a <i>fire-resistance rating</i> not less than 1 h," and to Clause (f). [F03, F04-OS1.2] [F04-OS1.3] Applies to portion of Code text: "a) ... floor assemblies shall be <i>fire separations</i> with a <i>fire-resistance rating</i> not less than 1 h," and to Clause (f). (b), (c), (d), (f) [F04-OP1.3] (b), (c), (d), (f) [F04-OS1.3] (a), (f) [F03-OP1.2] [F04-OP1.2, OP1.3] (a), (f) [F03-OS1.2] [F04-OS1.2, OS1.3] (e) [F03, F06-OS1.2] [F05, F06-OS1.5] (e) [F03, F06-OP1.2]
(3)	
(4)	[F02, F03-OS1.2] [F10-OS1.5]
rs	3.2.2.51. Group D, up to 6 Storeys, Sprinklered, Noncombustible Construction
(1)	[F02, F04-OP1.2, OP1.3] Applies to portion of Code text: " a) ...the <i>building</i> is <i>sprinklered</i> ," [F02, F04-OS1.2, OS1.3] Applies to portion of Code text: " a)... the <i>building</i> is <i>sprinklered</i> ,"
(2)	[F02-OP1.2] Applies to portion of Code text: "... the <i>building</i> referred to in Sentence (1) shall be of <i>noncombustible construction</i> ," [F02-OS1.2] Applies to portion of Code text: "... the <i>building</i> referred to in Sentence (1) shall be of <i>noncombustible construction</i> ," (a), (c) [F03, F04-OP1.2] [F04-OP1.3] (a), (c) [F03, F04-OS1.2] [F04-OS1.3] (b) [F04-OP1.3] (b) [F04-OS1.3]

Acceptable Solutions	Objectives and Functional Statements
3.2.2.52.	Group D, up to 4 Storeys, Sprinklered
(1)	[F02, F04-OP1.2, OP1.3] Applies to portion of Code text: " a)...the <i>building</i> is <i>sprinklered</i> ," [F02, F04-OS1.2, OS1.3] Applies to portion of Code text: " a)...the <i>building</i> is <i>sprinklered</i> ,"
(2)	(a), (c) [F03, F04-OP1.2] [F04-OP1.3] (a), (c) [F03, F04-OS1.2] [F04-OS1.3] (b) [F04-OP1.3] (b) [F04-OS1.3]
3.2.2.53.	Group D, up to 3 Storeys
(1)	
(2)	[F04-OP1.3] Applies to portion of Code text: "c) roof assemblies shall have, if of <i>combustible construction</i> , a <i>fire-resistance rating</i> not less than 45 min,..." and to Clause (d). [F04-OS1.3] Applies to portion of Code text: "c) roof assemblies shall have, if of <i>combustible construction</i> , a <i>fire-resistance rating</i> not less than 45 min,..." and to Clause (d). (a) [F03-OP1.2] Applies to the requirement that <i>noncombustible</i> floor assemblies be <i>fire separations</i> . (a) [F03-OS1.2] Applies to the requirement that <i>noncombustible</i> floor assemblies be <i>fire separations</i> . (a), (d) [F03, F04-OP1.2] [F04-OP1.3] (a), (d) [F03, F04-OS1.2] [F04-OS1.3] (b) [F04-OP1.3] (b) [F04-OS1.3]
3.2.2.54.	Group D, up to 3 Storeys, Sprinklered
(1)	[F02, F04-OP1.2, OP1.3] Applies to portion of Code text: " a)...the <i>building</i> is <i>sprinklered</i> ," [F02, F04-OS1.2, OS1.3] Applies to portion of Code text: " a)...the <i>building</i> is <i>sprinklered</i> ,"
(2)	(a) [F03-OP1.2] Applies to the requirement that <i>noncombustible</i> floor assemblies be <i>fire separations</i> . (a) [F03-OS1.2] Applies to the requirement that <i>noncombustible</i> floor assemblies be <i>fire separations</i> . (a), (c) [F03, F04-OP1.2] [F04-OP1.3] (a), (c) [F03, F04-OS1.2] [F04-OS1.3] (b) [F04-OP1.3] (b) [F04-OS1.3]
3.2.2.55.	Group D, up to 2 Storeys
(1)	
(2)	[F03, F04-OP1.2] [F04-OP1.3] [F03, F04-OS1.2] [F04-OS1.3] (a) [F03-OP1.2] Applies to the requirement that <i>noncombustible</i> floor assemblies be <i>fire separations</i> . (a) [F03-OS1.2] Applies to the requirement that <i>noncombustible</i> floor assemblies be <i>fire separations</i> .
3.2.2.56.	Group D, up to 2 Storeys, Sprinklered
(1)	[F02, F04-OP1.2, OP1.3] Applies to portion of Code text: "a) ...the <i>building</i> is <i>sprinklered</i> ," [F02, F04-OS1.2, OS1.3] Applies to portion of Code text: "a) ...the <i>building</i> is <i>sprinklered</i> ,"
(2)	[F03, F04-OP1.2] [F04-OP1.3] [F03, F04-OS1.2] [F04-OS1.3]

Acceptable Solutions	Objectives and Functional Statements
(2) (Cont'd)	(a) [F03-OP1.2] Applies to the requirement that <i>noncombustible</i> floor assemblies be <i>fire separations</i> .
	(a) [F03-OS1.2] Applies to the requirement that <i>noncombustible</i> floor assemblies be <i>fire separations</i> .
3.2.2.57.	Group E, Any Height, Any Area, Sprinklered
(1)	
(2)	[F02-OP1.2] Applies to portion of Code text: "... the <i>building</i> referred to in Sentence (1) shall be of <i>noncombustible construction</i> ,"
	[F02, F04-OP1.2, OP1.3] Applies to portion of Code text: " a) ... the <i>building</i> shall be <i>sprinklered</i> ,"
	[F02-OS1.2] Applies to portion of Code text: "... the <i>building</i> referred to in Sentence (1) shall be of <i>noncombustible construction</i> ,"
	[F02, F04-OS1.2, OS1.3] Applies to portion of Code text: " a) ... the <i>building</i> shall be <i>sprinklered</i> ,"
	(b), (d) [F03, F04-OP1.2] [F04-OP1.3]
	(b), (d) [F03, F04-OS1.2] [F04-OS1.3]
	(c) [F04-OP1.3]
	(c) [F04-OS1.3]
3.2.2.58.	Group E, up to 4 Storeys, Sprinklered
(1)	[F02, F04-OP1.2, OP1.3] Applies to portion of Code text: " a) ... the <i>building</i> shall be <i>sprinklered</i> ,"
	[F02, F04-OS1.2, OS1.3] Applies to portion of Code text: " a) ... the <i>building</i> shall be <i>sprinklered</i> ,"
(2)	(a), (c) [F03, F04-OP1.2] [F04-OP1.3]
	(a), (c) [F03, F04-OS1.2] [F04-OS1.3]
	(b) [F04-OP1.3]
	(b) [F04-OS1.3]
3.2.2.59.	Group E, up to 3 Storeys
(1)	
(2)	(a), (e) [F03, F04-OP1.2] [F04-OP1.3]
	(a), (e) [F03, F04-OS1.2] [F04-OS1.3]
	(b), (c), (d) [F04-OP1.3]
	(b), (c), (d) [F04-OS1.3]
3.2.2.60.	Group E, up to 3 Storeys, Sprinklered
(1)	[F02, F04-OP1.2, OP1.3] Applies to portion of Code text: " a) ... the <i>building</i> is <i>sprinklered</i> ,"
	[F02, F04-OS1.2, OS1.3] Applies to portion of Code text: " a) ... the <i>building</i> is <i>sprinklered</i> ,"
(2)	(a), (d) [F03, F04-OP1.2] [F04-OP1.3]
	(a), (d) [F03, F04-OS1.2] [F04-OS1.3]
	(b), (c) [F04-OP1.3]
	(b), (c) [F04-OS1.3]
3.2.2.61.	Group E, up to 2 Storeys
(1)	
(2)	[F03, F04-OS1.2] [F04-OS1.3]
	(a), (b) [F03, F04-OP1.2] [F04-OP1.3]
3.2.2.62.	Group E, up to 2 Storeys, Sprinklered
(1)	[F02, F04-OP1.2, OP1.3] Applies to portion of Code text: " a) ... the <i>building</i> is <i>sprinklered</i> ,"
	[F02, F04-OS1.2, OS1.3] Applies to portion of Code text: " a) ... the <i>building</i> is <i>sprinklered</i> ,"
(2)	[F03, F04-OS1.2] [F04-OS1.3]
	(a), (b) [F03, F04-OP1.2] [F04-OP1.3]
3.2.2.63.	Group F, Division 1, up to 4 Storeys, Sprinklered
(1)	
(2)	[F02-OP1.2] Applies to portion of Code text: "... the <i>building</i> referred to in Sentence (1) shall be of <i>noncombustible construction</i> ,"
	[F02, F04-OP1.2, OP1.3] Applies to portion of Code text: " a) ... the <i>building</i> shall be <i>sprinklered</i> ,"
	[F02-OS1.2] Applies to portion of Code text: "... the <i>building</i> referred to in Sentence (1) shall be of <i>noncombustible construction</i> ,"
	[F02, F04-OS1.2, OS1.3] Applies to portion of Code text: " a) ... the <i>building</i> shall be <i>sprinklered</i> ,"
	(b), (d) [F03, F04-OP1.2] [F04-OP1.3]
	(b), (d) [F03, F04-OS1.2] [F04-OS1.3]

Acceptable Solutions	Objectives and Functional Statements
(2) (Cont'd)	(c) [F04-OP1.3] (c) [F04-OS1.3]
3.2.2.64.	Group F, Division 1, up to 3 Storeys, Sprinklered
(1)	[F02, F04-OP1.2, OP1.3] Applies to portion of Code text: " a) ... the <i>building</i> is <i>sprinklered</i> ," [F02, F04-OS1.2, OS1.3] Applies to portion of Code text: " a) ... the <i>building</i> is <i>sprinklered</i> ,"
(2)	[F02-OP1.2] Applies to portion of Code text: "The <i>building</i> referred to in Sentence (1) is permitted to be of <i>heavy timber construction</i> or <i>noncombustible construction</i> used singly or in combination,..." [F03, F04-OP1.2] [F04-OP1.3] [F02-OS1.2] Applies to portion of Code text: "The <i>building</i> referred to in Sentence (1) is permitted to be of <i>heavy timber construction</i> or <i>noncombustible construction</i> used singly or in combination,..." [F03, F04-OS1.2] [F04-OS1.3]
3.2.2.65.	Group F, Division 1, up to 2 Storeys, Sprinklered
(1)	[F02, F04-OP1.2, OP1.3] Applies to portion of Code text: " a) ... the <i>building</i> is <i>sprinklered</i> ," [F02, F04-OS1.2, OS1.3] Applies to portion of Code text: " a) ... the <i>building</i> is <i>sprinklered</i> ,"
(2)	[F03-OP1.2] Applies to portion of Code text: "a) [noncombustible] floor assemblies shall be <i>fire separations</i> ..." [F04-OP1.2, OP1.3] [F03-OS1.2] Applies to portion of Code text: "a) [noncombustible] floor assemblies shall be <i>fire separations</i> ..." [F04-OS1.2, OS1.3]
3.2.2.66.	Group F, Division 1, One Storey
(1)	
3.2.2.67.	Group F, Division 2, Any Height, Any Area, Sprinklered
(1)	
(2)	[F02-OP1.2] Applies to portion of Code text: "... the <i>building</i> referred to in Sentence (1) shall be of <i>noncombustible construction</i> ," [F02, F04-OP1.2, OP1.3] Applies to portion of Code text: "a)... the <i>building</i> shall be <i>sprinklered</i> ," [F02-OS1.2] Applies to portion of Code text: "... the <i>building</i> referred to in Sentence (1) shall be of <i>noncombustible construction</i> ," [F02, F04-OS1.2, OS1.3] Applies to portion of Code text: " a)... the <i>building</i> shall be <i>sprinklered</i> ," (b), (d) [F03, F04-OP1.2] [F04-OP1.3] (b), (d) [F03, F04-OS1.2] [F04-OS1.3] (c) [F04-OP1.3] (c) [F04-OS1.3]
3.2.2.68.	Group F, Division 2, up to 6 Storeys
(1)	
(2)	[F02-OP1.2] Applies to portion of Code text: "the <i>building</i> referred to in Sentence (1) shall be of <i>noncombustible construction</i> ," [F04-OP1.3] Applies to portion of Code text: "c) roof assemblies shall have a <i>fire-resistance rating</i> not less than 1 h," and to Clause (d). [F02-OS1.2] Applies to portion of Code text: "the <i>building</i> referred to in Sentence (1) shall be of <i>noncombustible construction</i> ," [F04-OS1.3] Applies to portion of Code text: "c) roof assemblies shall have a <i>fire-resistance rating</i> not less than 1 h," and to Clause (d). (a), (d) [F03, F04-OP1.2] [F04-OP1.3] (a), (d) [F03, F04-OS1.2] [F04-OS1.3] (b) [F04-OP1.3] (b) [F04-OS1.3]
3.2.2.69.	Group F, Division 2, up to 4 Storeys, Increased Area
(1)	
(2)	[F02-OP1.2] Applies to portion of Code text: "the <i>building</i> referred to in Sentence (1) shall be of <i>noncombustible construction</i> ," [F04-OP1.3] Applies to portion of Code text: "c) ... roof assemblies shall have a <i>fire-resistance rating</i> not less than 1 h," and to Clause (d).

Acceptable Solutions	Objectives and Functional Statements
(2) (Cont'd)	[F02-OS1.2] Applies to portion of Code text: "the <i>building</i> referred to in Sentence (1) shall be of <i>noncombustible construction</i> ," [F04-OS1.3] Applies to portion of Code text: "c) ... roof assemblies shall have a <i>fire-resistance rating</i> not less than 1 h," and to Clause (d). (a) [F03, F04-OP1.2] [F04-OP1.3] (a) [F03, F04-OS1.2] [F04-OS1.3] (b) [F04-OP1.3] (b) [F04-OS1.3]
3.2.2.70.	Group F, Division 2, up to 4 Storeys
(1)	
(2)	(a), (e) [F03, F04-OP1.2] [F04-OP1.3] (a), (e) [F03, F04-OS1.2] [F04-OS1.3] (b), (c), (d) [F04-OP1.3] (b), (c), (d) [F04-OS1.3]
3.2.2.71.	Group F, Division 2, up to 2 Storeys
(1)	
(2)	[F03, F04-OP1.2] [F04-OP1.3] [F03, F04-OS1.2] [F04-OS1.3] (a) [F03-OP1.2] Applies to the requirement that <i>noncombustible</i> floor assemblies be <i>fire separations</i> . (a) [F03-OS1.2] Applies to the requirement that <i>noncombustible</i> floor assemblies be <i>fire separations</i> .
3.2.2.72.	Group F, Division 2, up to 2 Storeys, Sprinklered
(1)	[F02, F04-OP1.2, OP1.3] Applies to portion of Code text: "a)... the <i>building</i> is <i>sprinklered</i> ," [F02, F04-OS1.2, OS1.3] Applies to portion of Code text: " a)... the <i>building</i> is <i>sprinklered</i> ,"
(2)	[F03, F04-OP1.2] [F04-OP1.3] [F03, F04-OS1.2] [F04-OS1.3] (a) [F03-OP1.2] Applies to the requirement that <i>noncombustible</i> floor assemblies be <i>fire separations</i> . (a) [F03-OS1.2] Applies to the requirement that <i>noncombustible</i> floor assemblies be <i>fire separations</i> .
3.2.2.73.	Group F, Division 3, Any Height, Any Area
(1)	
(2)	[F02-OP1.2] Applies to portion of Code text: "...the <i>building</i> referred to in Sentence (1) shall be of <i>noncombustible construction</i> ," [F02-OS1.2] Applies to portion of Code text: "...the <i>building</i> referred to in Sentence (1) shall be of <i>noncombustible construction</i> ," (b), (d) [F03, F04-OP1.2] [F04-OP1.3] (b), (d) [F03, F04-OS1.2] [F04-OS1.3] (c) [F04-OP1.3] (c) [F04-OS1.3]
3.2.2.74.	Group F, Division 3, up to 6 Storeys
(1)	
(2)	[F02-OP1.2] Applies to portion of Code text: "The <i>building</i> referred to in Sentence (1) shall be of <i>noncombustible construction</i> ," [F02-OS1.2] Applies to portion of Code text: "The <i>building</i> referred to in Sentence (1) shall be of <i>noncombustible construction</i> ," (a), (d) [F03, F04-OP1.2] [F04-OP1.3] (a), (d) [F03, F04-OS1.2] [F04-OS1.3] (b), (c) [F04-OP1.3] (b), (c) [F04-OS1.3]
3.2.2.75.	Group F, Division 3, up to 6 Storeys, Sprinklered
(1)	[F02, F04-OP1.2, OP1.3] Applies to portion of Code text: "a)... the <i>building</i> is <i>sprinklered</i> ," [F02, F04-OS1.2, OS1.3] Applies to portion of Code text: "a)... the <i>building</i> is <i>sprinklered</i> ,"
(2)	[F02-OP1.2] Applies to portion of Code text: "... the <i>building</i> referred to in Sentence (1) shall be of <i>noncombustible construction</i> ,"

Acceptable Solutions	Objectives and Functional Statements
(2) (Cont'd)	[F02-OS1.2] Applies to portion of Code text: "... the <i>building</i> referred to in Sentence (1) shall be of <i>noncombustible construction</i> ," (a), (c) [F03, F04-OP1.2] [F04-OP1.3] (a), (c) [F03, F04-OS1.2] [F04-OS1.3] (b) [F04-OP1.3] (b) [F04-OS1.3]
3.2.2.76.	Group F, Division 3, up to 4 Storeys
(1)	
(2)	[F04-OP1.3] Applies to portion of Code text: "(c) roof assemblies shall have, if of <i>combustible construction</i> , a <i>fire-resistance rating</i> not less than 45 min, ..." and to Clause (d). [F04-OS1.3] Applies to portion of Code text: "(c) roof assemblies shall have, if of <i>combustible construction</i> , a <i>fire-resistance rating</i> not less than 45 min, ..." and to Clause (d). (a) [F03-OP1.2] Applies to the requirement that <i>noncombustible</i> floor assemblies be <i>fire separations</i> . (a) [F03-OS1.2] Applies to the requirement that <i>noncombustible</i> floor assemblies be <i>fire separations</i> . (a), (d) [F03, F04-OP1.2] [F04-OP1.3] (a), (d) [F03, F04-OS1.2] [F04-OS1.3] (b) [F04-OP1.3] (b) [F04-OS1.3]
3.2.2.77.	Group F, Division 3, up to 4 Storeys, Sprinklered
(1)	[F02, F04-OP1.2, OP1.3] Applies to portion of Code text: "(a) the <i>building</i> is <i>sprinklered</i> ," [F02, F04-OS1.2, OS1.3] Applies to portion of Code text: "(a) the <i>building</i> is <i>sprinklered</i> ,"
(2)	(a) [F03-OP1.2] Applies to the requirement that <i>noncombustible</i> floor assemblies be <i>fire separations</i> . (a) [F03-OS1.2] Applies to the requirement that <i>noncombustible</i> floor assemblies be <i>fire separations</i> . (a), (c) [F03, F04-OP1.2] [F04-OP1.3] (a), (c) [F03, F04-OS1.2] [F04-OS1.3] (b) [F04-OP1.3] (b) [F04-OS1.3]
3.2.2.78.	Group F, Division 3, up to 2 Storeys
(1)	
(2)	[F03, F04-OP1.2] [F04-OP1.3] [F03, F04-OS1.2] [F04-OS1.3] (a) [F03-OP1.2] Applies to the requirement that <i>noncombustible</i> floor assemblies be <i>fire separations</i> . (a) [F03-OS1.2] Applies to the requirement that <i>noncombustible</i> floor assemblies be <i>fire separations</i> .
3.2.2.79.	Group F, Division 3, up to 2 Storeys, Sprinklered
(1)	[F02, F04-OP1.2, OP1.3] Applies to portion of Code text: "(a)... the <i>building</i> is <i>sprinklered</i> ," [F02, F04-OS1.2, OS1.3] Applies to portion of Code text: "(a)... the <i>building</i> is <i>sprinklered</i> ,"
(2)	[F03, F04-OP1.2] [F04-OP1.3] [F03, F04-OS1.2] [F04-OS1.3] (a) [F03-OP1.2] Applies to the requirement that <i>noncombustible</i> floor assemblies be <i>fire separations</i> . (a) [F03-OS1.2] Applies to the requirement that <i>noncombustible</i> floor assemblies be <i>fire separations</i> .
3.2.2.80.	Group F, Division 3, One Storey
(1)	[F02-OP1.2] Applies to portion of Code text: "A <i>building</i> classified as Group F, Division 3 is permitted to be of <i>heavy timber construction</i> or <i>noncombustible construction</i> used singly or in combination ..." [F02-OS1.2] Applies to portion of Code text: "A <i>building</i> classified as Group F, Division 3 is permitted to be of <i>heavy timber construction</i> or <i>noncombustible construction</i> used singly or in combination ..."
3.2.2.81.	Group F, Division 3, One Storey, Sprinklered
(1)	[F02-OP1.2] Applies to portion of Code text: "A <i>building</i> classified as Group F, Division 3 is permitted to be of <i>heavy timber construction</i> or <i>noncombustible construction</i> used singly or in combination ..." [F02, F04-OP1.2, OP1.3] Applies to portion of Code text: "(a) ... the <i>building</i> is <i>sprinklered</i> ," [F02-OS1.2] Applies to portion of Code text: "A <i>building</i> classified as Group F, Division 3 is permitted to be of <i>heavy timber construction</i> or <i>noncombustible construction</i> used singly or in combination ..." [F02, F04-OS1.2, OS1.3] Applies to portion of Code text: "(a) ... the <i>building</i> is <i>sprinklered</i> ,"

Acceptable Solutions	Objectives and Functional Statements
3.2.2.82.	Group F, Division 3, One Storey, Any Area, Low Fire Load Occupancy
(1)	
(2)	[F02-OP1.2] [F02-OS1.2]
3.2.2.83.	Group F, Division 3, Storage Garages up to 22 m High
(1)	[F02-OP1.2] Applies to portion of Code text: "A building used as a storage garage with all storeys constructed as open-air storeys and having on other occupancy above it is permitted to have its floor, wall, ceiling and roof assemblies constructed without a fire-resistance rating provided it is a) of noncombustible construction," [F02-OS1.2] Applies to portion of Code text: "A building used as a storage garage with all storeys constructed as open-air storeys and having on other occupancy above it is permitted to have its floor, wall, ceiling and roof assemblies constructed without a fire-resistance rating provided it is a) of noncombustible construction,"
3.2.3.1.	Limiting Distance and Area of Unprotected Openings
(1)	[F03-OP3.1]
(2)	
(3)	
(4)	
(5)	[F03-OP3.1]
(6)	[F03-OP3.1]
(7)	
(8)	[F03-OP3.1]
(9)	[F03-OP3.1]
(10)	[F03-OP3.1]
(11), (12)	
3.2.3.2.	Area of Exposing Building Face
(1)	
(2)	[F03-OP3.1]
(3)	
3.2.3.3.	Wall Enclosing Attic or Roof Space
(1)	
3.2.3.4.	Reserved
3.2.3.5.	Wall with Limiting Distance Less Than 1.2 m
(1)	[F03-OP3.1]
(2)	[F03-OP3.1]
3.2.3.6.	Combustible Projections
(1)	[F03-OP3.1]
(2)	[F03-OP3.1]
(3)	[F03-OP3.1]
(3.1)	
(4)	[F03-OP3.1]
(5)	
3.2.3.7.	Construction of Exposing Building Face
(1)	[F02, F03-OP3.1]
(2)	
(3)	[F02, F03-OP3.1]
(4)	
(5)	[F02, F03-OP3.1]
(6)	[F02, F03-OP3.1]
(7), (8)	
3.2.3.8.	Protection of Exterior Building Face
(1)	[F02, F03-OP3.1]
(2)	
(3)	

e6.1

r11.1

r5

Acceptable Solutions	Objectives and Functional Statements
3.2.3.9.	Protection of Structural Members
(1)	[F04-OP1.3] [F04-OS1.3]
(2)	
3.2.3.10.	Unlimited Unprotected Openings
(1)	[F03-OP3.1]
(2)	[F03-OP3.1]
3.2.3.11.	Low Fire Load, One Storey Building
(1)	(a) [F04-OP3.1] (b) [F03-OP3.1]
3.2.3.12.	Area Increase for Unprotected Openings
(1)	[F03-OP3.1]
3.2.3.13.	Protection of Exit Facilities
(1)	
(2)	
(3)	
(4)	[F06-OP1.2] [F05, F06-OS1.2]
3.2.3.14.	Wall Exposed to Another Wall
(1)	[F03-OP1.2] [F03-OP3.1] [F03-OS1.2]
(2)	[F03-OP1.2] [F03-OP3.1] [F03-OS1.2]
(3)	
3.2.3.15.	Wall Exposed to Adjoining Roof
(1)	[F03-OP1.2] [F03-OS1.2]
3.2.3.16.	Protection of Soffits
(1)	[F03-OP1.2] [F03-OS1.2]
(2)	[F03-OP1.2] [F03-OS1.2]
(3)	[F03-OP1.2] [F03-OS1.2]
(4)	[F02-OP1.2] [F02-OS1.2]
3.2.3.17.	Canopy Protection for Vertically Separated Openings
(1)	[F03-OP1.2] [F03-OS1.2]
(2)	[F03-OP1.2] [F03-OS1.2]
(3)	[F02-OP1.2] [F02-OS1.2]
3.2.3.18.	Covered Vehicular Passageway
(1)	[F03-OP3.1]
(2)	[F03-OP3.1]
3.2.3.19.	Walkway between Buildings
(1)	[F03-OP3.1]
(2)	[F02-OP3.1]
(3)	[F02, F12-OP3.1]

Acceptable Solutions	Objectives and Functional Statements
(4)	
(5)	
3.2.3.20.	Underground Walkway
(1)	[F01, F02-OP3.1]
(2)	[F03-OP3.1]
(3)	[F02-OP3.1] Applies to portion of Code text: "An underground walkway shall be of <i>noncombustible construction</i> ..." [F80-OP2.3] Applies to portion of Code text: "An underground walkway shall be ... suitable for an underground location."
(4)	(a) [F06-OS1.2] [F05-OS1.5] (b) [F12-OS1.2] [F10-OS1.5]
(5)	
3.2.3.21.	Installation of Services Lines Under Buildings
(1)	[F01-OS1.1]
3.2.4.1.	Determination of Requirement for a Fire Alarm System
(1)	
(2)	[F11-OS1.5]
(3)	
(4)	
(5)	
3.2.4.2.	Continuity of Fire Alarm System
(1)	[F11-OS1.5]
(2)	[F11-OS1.5]
(3)	[F11-OS1.5]
(4)	[F03-OS1.2] [F10-OS1.5]
(5)	[F11, F13-OS1.2] [F11-OS1.5]
3.2.4.3.	Types of Fire Alarm Systems
(1)	(a) [F11-OS1.5] (b) [F11-OS1.4] [F13-OS1.5] (c), (d), (e) [F11-OS1.5]
3.2.4.4.	Description of Fire Alarm Systems
(1)	[F11-OS1.5]
(2)	(a), (d) [F11-OS1.4] [F13-OS1.5] (b), (c) [F11-OS1.5]
(3)	[F13-OS1.5]
(4)	[F13-OS1.5]
3.2.4.5.	Installation and Verification of Fire Alarm Systems
(1)	[F12, F13, F81-OS1.2] [F11, F12, F13, F81-OS1.5] [F11, F12-OS3.7] Applies to voice communication systems.
(2)	[F82-OS1.5]
3.2.4.6.	Reserved
3.2.4.7.	Silencing of Alarm Signals
(1)	[F11-OS1.5]
(2)	[F34, F81-OS1.5]
(3)	
3.2.4.8.	Signals to Fire Department
(1)	[F13-OP1.2] [F13-OS1.2, OS1.5]
(2)	[F13-OP1.2] [F13-OS1.2, OS1.5]
(3)	[F13-OP1.2] [F13-OS1.2, OS1.5]

r11.1

Acceptable Solutions	Objectives and Functional Statements
(4)	[F13, F81-OP1.2] [F13, F81-OS1.2, OS1.5]
(5)	[F13-OP1.2] [F13-OS1.2, OS1.5]
3.2.4.9.	Annunciator and Zone Indication
(1)	[F12-OS1.2, OS1.5]
(2)	[F12-OS1.2, OS1.5]
(3)	
(4)	[F12-OS1.2, OS1.5]
(5)	
(6)	
(7)	[F12-OS1.2, OS1.5]
(8)	[F12-OS1.2, OS1.5]
(9)	[F12-OS1.2, OS1.5]
3.2.4.10.	Electrical Supervision
(1)	[F82-OS1.2, OS1.5]
(2)	F82-OS1.2] F82-OP1.2]
(3)	(a), (d), (e), (f), (g) [F82-OP1.2] (a), (d), (e), (f), (g) [F82-OS1.2] b), (c) [F82-OS1.5]
(4)	[F81, F82-OP1.2] [F81, F82-OS1.2]
(5)	(a), (b) [F81, F82-OP1.2] (a), (b) [F81, F82-OS1.2] (c) [F81, F82 - OS1.5]
(6)	[F82-OP1.2] [F82-OS1.2]
3.2.4.11.	Fire Detectors
(1)	[F11-OS1.5]
(2)	[F11-OS1.5]
3.2.4.12.	Smoke and Heat Detectors
(1)	[F11-OS1.5]
(2)	[F11-OS1.5]
(3)	[F12-OS1.5]
(4)	[F10-OS1.5]
(5)	[F11-OS1.5]
(6)	
(7)	[F11-OS1.4, OS1.5]
3.2.4.13.	Prevention of Smoke Circulation
(1)	[F03-OS1.2]
3.2.4.14.	Vacuum Cleaning System Shutdown
(1)	[F03-OS1.2]
3.2.4.15.	Elevator Emergency Return
(1)	[F10-OS1.5]
(2)	[F11-OS1.5]
(3)	[F02-OS1.2]
3.2.4.16.	Sprinklers in Lieu of Fire Detectors
(1)	[F02-OS1.2] [F11-OS1.5]
3.2.4.17.	System Monitoring
(1)	[F12-OS1.2] [F11, F12-OS1.5] [F12-OP1.2]

Acceptable Solutions	Objectives and Functional Statements
(2)	[F13-OS1.2] [F11, F13-OS1.5] [F13-OP1.2]
3.2.4.18.	Manual Pull Stations
(1)	[F11-OS1.5]
(2)	[F02, F12-OS1.2] [F10, F12-OS1.5]
(3)	[F02, F12-OS1.2] [F10, F12-OS1.5]
(4)	[F11-OS1.5]
(5)	[F11-OS1.5]
(6)	[F81-OS1.2] [F11, F81-OS1.5]
(7)	[F11-OS1.5]
(8)	
3.2.4.19.	Alert and Alarm Signals
(1)	
(2)	[F11-OS1.5]
(3)	[F11-OS1.5]
(4)	[F11-OS1.5]
e2.1 (5), (6)	
3.2.4.20.	Audibility of Alarm Systems
(1)	[F11-OS1.5]
(2)	[F11-OS1.5]
(3)	[F11-OS1.5]
(4)	[F33-OS3.5]
(5)	[F11-OS1.5]
(6)	[F11-OS1.5]
(7)	[F11-OS1.5]
(8)	
(9)	[F11, F81-OS1.5]
(10)	[F11, F81-OS1.5]
(11)	[F11, F81-OS1.5]
(12)	[F11-OS1.5]
(13)	
(14)	[F11-OS1.5]
3.2.4.21.	Visual Signals
(1)	[F11-OS1.5]
(2)	[F11-OS1.5]
3.2.4.22.	Smoke Alarms
r11.1 (0.1)	
(1)	[F11, F81-OS1.5]
(2)	[F11-OS1.5]
(3)	[F11-OS1.5]
(4)	[F11-OS1.5]
(5)	[F11,F81-OS1.5]
(6)	[F11,F81-OS1.5]
(7)	
(8)	[F11-OS1.5]
(9)	[F81,F11-OS1.5]
(10)	[F81,F11-OS1.5]
(11)	
(12)	[F11-OS1.5]
r5 (13)	[F74-OA-2] [F11-OS1.5]
r5 (14)	
r5 (15)	[F74-OA-2] [F11-OS1.5]
r6 (16)	[F11,F81-OS1.5]

	Acceptable Solutions	Objectives and Functional Statements
r11.1	3.2.4.22A.	Residential Fire Warning Systems
	(1)	[F81, F11-OS1.5]
r11.1	3.2.4.23.	Two-Way Voice Communication Systems
	(1)	[F11, F12-OS3.7]
	(2)	[F11-OS1.5]
	(3)	[F11-OS1.5]
	(4)	F11-OS1.5] [F13-OS1.4, OS1.5]
	(5)	[F11-OS1.5]
	(6)	[F12-OS3.7]
	(7)	[F11-OS1.5]
r11.1	3.2.4.24.	One-Way Voice Communication Systems
	(1) to (3)	[F11-OS1.5]
e3	(4)	
	3.2.5.1.	Access to Above Grade Storeys
	(1)	[F12-OP1.2] [F12-OS1.2, OS1.5]
	(2)	[F12-OP1.2] [F12-OS1.2, OS1.5]
	(3)	[F12-OP1.2] [F12-OS1.2, OS1.5]
	3.2.5.2.	Access to Basements
	(1), (2)	[F12-OP1.2] [F12-OS1.2, OS1.5]
	3.2.5.3.	Roof Access
	(1)	[F12-OP1.2] [F12-OS1.2]
	(2)	[F12-OP1.2] [F12-OS1.2] [F05, F06, F10, F12-OS3.7]
	3.2.5.4.	Access Routes
	(1)	[F12-OP1.2] [F12-OS1.2, OS1.5]
3.2.5.5.	Location of Access Routes	
(1)	[F12-OP1.2] [F06-OS1.1] [F12-OS1.2, OS1.5]	
(2)	[F12-OP1.2] [F12-OS1.2]	
(3)		
(4)	[F12-OP1.2] [F12-OS1.2]	
3.2.5.6.	Access Route Design	
(1)	[F12-OP1.2] [F12-OS1.2]	
r5	(2)	[F12-OP1.2] [F12-OS1.2]
	3.2.5.7.	Water Supply
(1)	[F02-OP1.2] [F02-OP3.1] [F02-OS1.2]	
(2)	[F02, F12-OP1.2] [F02-OP3.1] [F02, F12-OS1.2]	

	Acceptable Solutions	Objectives and Functional Statements
e3	3.2.5.8. to 3.2.5.12.	Reserved
	3.2.5.13.	Automatic Sprinkler Systems
	(1)	[F02, F81, F82-OP1.2] [F02, F81, F82-OS1.2]
	(2)	[F02, F81, F82-OP1.2] [F02, F81, F82-OS1.2]
	(3)	[F02, F81, F82-OP1.2] [F02, F81, F82-OS1.2]
	(4)	[F02-OP1.2] [F02-OS1.2]
	(5)	[F81-OP1.2] [F81-OS1.2]
	(6)	[F02-OP1.2] [F02-OS1.2]
r5	(7)	[F02, F81, F82-OP1.2] [F02, F81, F82-OS1.2]
r5	(8)	[F81-OS3.3, OS3.6]
r5	(9)	[F02, F04 – OP1.2, OP1.3] [F02, F04 – OS1.2, OS1.3]
	3.2.5.14.	Combustible Sprinkler Piping
	(1)	[F06-OP1.2] [F06-OS1.2]
	(2)	[F02, F81-OP1.2] [F02, F81-OS1.2]
	(3)	[F06-OP1.2] [F06-OS1.2]
	(4)	[F06-OP1.2] [F06-OS1.2]
	(5)	
	3.2.5.15.	Sprinklered Service Space
	(1)	[F02-OP1.2] [F02-OS1.2]
	(2)	[F12-OP1.2] [F12-OS1.2]
	(3)	[F12-OS1.2] [F11, F12-OS1.5] [F12-OP1.2]
	(4)	[F02-OP1.2] [F02-OS1.2]
	(5)	
	3.2.5.16.	Fire Department Connections
	(1)	[F12-OP1.2] [F12-OS1.2]
	(2)	[F12-OP1.2] [F12-OS1.2]
	(3)	[F12-OP1.2] [F12-OS1.2]
	3.2.5.17.	Portable Fire Extinguishers
	(1)	[F02, F12, F81-OP1.2] [F02, F12, F81-OS1.2]
	(2)	[F12-OP1.2] [F12-OS1.2]

Acceptable Solutions	Objectives and Functional Statements	
3.2.5.18.	Protection from Freezing	
(1)	[F81-OP1.2]	
	[F81-OS1.2]	
3.2.5.19.	Fire Pumps	
(1)	[F02, F81-OP1.2]	
	[F02, F81-OS1.2]	
3.2.6.1.	Application	
(1)		
3.2.6.2.	Limits to Smoke Movement	
(1)	[F02-OP1.2]	
	[F02-OS1.2, OS1.5]	
E6.1	(2), (3)	[F06-OP1.2]
		[F06-OS1.2] [F05, F06-OS1.5]
(4)	[F03, F12-OP1.2]	
	[F03 F12-OS1.2, OS1.5]	
(5)	[F03-OP1.2]	
	[F03-OS1.2, OS1.5]	
F11.1	(5.1)	[F03, F12-OP1.2]
		[F03, F12-OS1.2, OS1.5]
(6)	[F02-OP1.2]	
	[F02-OS1.2, OS1.5]	
3.2.6.3.	Connected Buildings	
(1)	[F03-OP1.2]	
	[F03-OP3.1]	
	[F03-OS1.2, OS1.5]	
3.2.6.4.	Emergency Operation of Elevators	
(1)	[F12-OP1.2]	
	[F12-OS1.2, OS1.5]	
(2)	[F12-OP1.2]	
	[F12-OS1.2, OS1.5]	
(3)	[F12-OP1.2]	
	[F12-OS1.2, OS1.5]	
(4)	[F12-OP1.2]	
	[F12-OS1.2, OS1.5]	
(5)	[F12-OP1.2]	
	[F12-OS1.2, OS1.5]	
(6)	[F12-OP1.2]	
	[F12-OS1.2, OS1.5]	
(7)	[F11-OS1.5]	
3.2.6.5.	Elevator for Use by Firefighters	
(1)	[F12, F06-OP1.2]	
	[F12, F06-OS1.2, OS1.5]	
(2)	[F12-OP1.2]	
	[F12-OS1.2, OS1.5]	
(3)	[F06-OP1.2]	
	[F06-OS1.2, OS1.5]	
(4)	[F12-OP1.2]	
	[F12-OS1.2, OS1.5]	
(5)	[F12-OP1.2]	
	[F12-OS1.2, OS1.5]	
(6)	[F06-OP1.2]	
	[F06-OS1.2, OS1.5]	

Acceptable Solutions	Objectives and Functional Statements
3.2.6.6.	Venting to Aid Firefighting
(1)	[F06-OP1.2] [F06-OS1.2, OS1.5]
(2)	[F30-OS3.1]
(3)	[F12-OP1.2] [F12-OS1.2, OS1.5]
(4)	[F03-OS1.2] [F12-OS1.2, OS1.5]
(5)	
3.2.6.7.	Central Alarm and Control Facility
(1)	[F12-OP1.2] [F12-OS1.2, OS1.5]
(2)	[F12-OP1.2] [F12-OS1.2, OS1.5] [F11-OS1.5]
3.2.6.8.	Voice Communication System
(1)	[F12,F11-OS3.7]
3.2.6.9.	Testing
(1)	[F82-OP1.2] [F82-OS1.2, OS1.5]
3.2.7.1.	Minimum Lighting Requirements
(1)	[F30-OS3.1] [F10-OS3.7]
(2)	[F30-OS3.1] [F10-OS3.7]
(3)	
(4)	
(5)	[F30-OS3.1] [F10-OS3.7]
(6)	[F30-OS3.1] [F10-OS3.7]
(7)	[F30-OS3.1] [F10-OS3.7] [F40-OH2.4]
(8)	[F30-OS3.1] [F10-OS3.7] [F40-OH2.4]
3.2.7.2.	Recessed Lighting Fixtures
(1)	[F01-OP1.1, OP1.2] [F01-OS1.1, OS1.2]
3.2.7.3.	Emergency Lighting
(1)	[F30-OS3.1] [F10-OS3.7]
(2)	[F30-OS3.1] [F10-OS3.7]
(3)	[F30-OS3.1] [F10-OS3.7]
(4)	[F30-OS3.1] [F10-OS3.7]
3.2.7.4.	Emergency Power for Lighting
(1)	[F30-OS3.1] [F10-OS3.7]
(2)	[F30, F81-OS3.1] [F10, F81-OS3.7]
3.2.7.5.	Emergency Power Supply Installation
(1)	[F02, F03, F06, F10, F11, F12, F81-OS1.2, OS1.5] [F02, F06, F30, F81-OS3.1] [F10, F11, F12, F81-OS3.7] [F02, F03, F06, F81-OP1.2]
(2)	[F12-OS1.5]
3.2.7.6.	Emergency Power for Hospitals
(1)	[F02, F03, F06, F10, F11, F12, F81-OS1.2, OS1.5] [F02, F06, F30, F81-OS3.1] [F10, F11, F12, F81-OS3.7] [F02, F03, F06, F81-OP1.2]
3.2.7.7.	Fuel Supply Shut-off Valves and Exhaust Pipes
(1)	[F12-OH5] Applies to the requirement for a suitably identified shut-off valve outside the <i>building</i> [F12-OP1.2] Applies to the requirement for a suitably identified shut-off valve outside the building

Acceptable Solutions	Objectives and Functional Statements
(1) (Cont'd)	[F12-OS1.1, OS1.2] Applies to the requirement for a suitably identified shut-off valve outside the building [F12-OS1.2, OS1.5] Applies to the requirement for a suitably identified separate shut-off valve. [F81-OS3.1, OS3.7] Applies to the requirement for a suitably identified separate shut-off valve.
(2)	[F03-OP1.2] [F03-OS1.2]
3.2.7.8. Emergency Power for Fire Alarm Systems	
(1)	[F13-OS1.2] [F11, F13-OS1.5] [F13-OP1.2] Applies to the requirement for fire alarm systems, including those with a voice communication system, to be provided with an emergency power supply.
(2)	[F13-OS1.2] [F11, F13-OS1.5] [F13-OP1.2]
(3)	[F13-OS1.2] [F11, F13-OS1.5] [F13-OP1.2]
(4)	[F13-OS1.2] [F11, F13-OS1.5] [F13-OP1.2]
3.2.7.9. Emergency Power for Building Services	
(1)	[F02, F03, F12-OP1.2] [F02, F03, F12-OS1.2, OS1.5] (a) [F36-OS3.6] [F10, F12-OS3.7] (b) [F02-OP3.1]
(2)	[F12-OP1.2] [F12-OS1.2, OS1.5] [F36-OS3.6] [F12-OS3.7]
(3)	
(4)	[F02, F03-OP1.2] [F02, F03-OS1.2, OS1.5] [F02-OP3.1]
(5)	
(6)	
3.2.7.10. Protection of Electrical Conductors	
(1)	
(2)	[F06-OP1.2] [F06-OS1.2, OS1.5]
(3)	[F06-OP1.2] [F06-OS1.2, OS1.5]
(4)	[F06-OP1.2] [F06-OS1.2, OS1.5]
(5)	
(6)	[F06-OP1.2] [F06-OS1.2, OS1.5]
(7)	
(8)	[F06-OP1.2] [F06-OS1.2, OS1.5]
(9)	
R11.1	(10) [F06-OS1.4] [F06-OP1.2] [F10-OS3.7]
R11.1	(11)
3.2.8.1. Application	
(1)	[F03, F06-OP1.2] [F03, F06-OS1.2] [F05-OS1.5]
e6.1	(2) to (5)

Acceptable Solutions	Objectives and Functional Statements
3.2.8.2.	Exceptions to Special Protection
(1)	
(2)	
(3)	[F03-OP1.2] [F03-OS1.2]
(4)	
(5)	[F02, F03-OP1.2] [F02, F03-OS1.2]
(6)	
3.2.8.3.	Configuration
(1)	[F02, F03-OP1.2] [F02, F03-OS1.2]
(2)	
3.2.8.4.	Exits
(1)	[F06-OP1.2] [F06-OS1.2] [F05, F06, F10-OS1.5]
(2)	[F06-OP1.2] [F06-OS1.2] [F05, F06, F10-OS1.5]
(3)	[F06-OP1.2] [F06-OS1.2] [F05, F06, F10-OS1.5]
(4)	
(5)	[F06-OS1.2] [F05, F06, F10-OS1.5]
(6)	[F10-OS1.5]
(7)	[F10-OS1.5]
(8)	[F10-OS1.5]
3.2.8.5.	Elevators
(1)	[F06-OP1.2] [F06-OS1.2] [F05, F06-OS1.5]
(2)	
3.2.8.6.	Group B Sleeping Rooms
(1)	[F03, F06-OP1.2] [F06-OS1.2] [F05-OS1.5]
3.2.8.7.	Sprinklers
(1)	[F02, F04-OP1.2, OP1.3] [F02, F04-OS1.2, OS1.3]
(2)	
3.2.8.8.	Fire Alarm and Detection System
(1)	
3.2.8.9.	Smoke
(1)	
(2)	
(3)	(a) [F06-OP1.2] (a) [F06-OS1.2] [F05, F06-OS1.5]
(4)	[F06-OP1.2] [F06-OS1.2] [F05, F06-OS1.5]
(5)	
(6)	[F06-OP1.2] [F06-OS1.2] [F05, F06-OS1.5]
(7)	[F06-OP1.2] [F06-OS1.2] [F05, F06-OS1.5]
(8)	[F12-OP1.2] [F12-OS1.2, OS1.5]

Acceptable Solutions	Objectives and Functional Statements
3.2.8.10.	Emergency Power Supply
(1)	[F02, F03, F12-OP1.2]
	[F02, F03, F12-OS1.2, OS1.5]
3.2.8.11.	Testing
(1)	[F82-OP1.2]
	[F82-OS1.2, OS1.5]
3.2.9.1.	Where Required
(1)	[F02-OP1.2]
	[F02-OS1.2]
(2)	
(3)	
(4)	
(5)	
(6)	
(7)	
3.2.9.2.	Standpipe System Design
(1)	[F02, F81-OP1.2]
	[F02, F81-OS1.2]
(2)	[F12-OP1.2]
	[F12-OS1.2]
(3)	
(4)	[F02-OP1.2]
	[F02-OS1.2]
(5)	[F12-OP1.2]
	[F12-OS1.2]
(6)	[F12-OP1.2]
	[F12-OS1.2]
(7)	[F81-OP1.2]
	[F81-OS1.2]
(8)	[F81-OP1.2]
	[F81-OS1.2]
(9)	[F02, F81-OP1.2]
	[F02, F81-OS1.2]
3.2.9.3.	Hose Connections
(1)	[F02, F03-OP1.2]
	[F02, F03-OS1.2]
(2)	[F02, F03-OP1.2]
	[F02, F03-OS1.2]
3.2.9.4.	Hose Stations
(1)	[F02, F03-OP1.2]
	[F02, F03-OS1.2]
(2)	[F02-OP1.2]
	[F02-OS1.2]
(3)	[F81-OP1.2]
	[F81-OS1.2]
(4)	[F02, F03, F81-OP1.2]
	[F02, F03, F81-OS1.2]
	(c) [F12-OP1.2]
	(c) [F12-OS1.2]
(5)	[F02, F12-OP1.2]
	[F02, F12-OS1.2]

e6.1
r11.1

Acceptable Solutions	Objectives and Functional Statements
(6)	[F03-OP1.2] [F03-OS1.2]
(7)	
(8)	[F03-OP1.2] [F03-OS1.2]
(9)	[F10-OS1.5]
(10)	[F81-OP1.2] [F81-OS1.2]
3.2.9.5.	Supervisory Signal Annunciation for Valves
(1)	[F82-OP1.2] [F82-OS1.2]
3.2.9.6.	Water Supply for 38 mm Hose Connections
(1)	[F02-OP1.2] [F02-OS1.2]
3.2.9.7.	Water Supply for 65 mm Hose Connections
(1)	[F02-OP1.2] [F02-OS1.2]
(2) to (4)	
3.2.10.1.	Testing
(1)	[F02, F81, F82-OS1.2, OS1.5] [F02, F81, F82-OP1.2]
3.3.1.1.	Separation of Suites
(1)	[F03-OP1.2] [F03-OS1.2]
(2)	[F02-OP1.2] [F02-OS1.2]
(3)	[F02-OP1.2] [F02-OS1.2]
3.3.1.2.	Hazardous Substances, Equipment and Processes
(1)	[F01, F02, F03-OP1.1, OP1.2] [F01, F02, F03-OS1.1, OS1.2] [F43-OS3.4]
(2)	
(3)	[F05-OS1.5] [F43-OS3.7]
3.3.1.3.	Means of Egress
(1)	
(2)	
(3)	[F10-OS3.7]
(4)	[F05, F06, F10, F12-OS3.7]
(5)	[F10, F12-OS3.7]
(6)	[F05, F06, F10, F12-OS3.7]
(7)	[F05, F06, F10, F12-OS3.7]
(8)	[F05-OS1.5]
(9)	[F05, F06, F10, F12-OS3.7]
(10)	
3.3.1.4.	Public Corridor Separations
(1)	[F06-OS1.2] [F03, F05, F06-OS1.5] [F03, F06-OP1.2]
(2)	[F06-OS1.2] [F03, F05, F06-OS1.5] [F03, F06-OP1.2]
(3)	[F06-OS1.2] [F03, F05, F06-OS1.5] [F03, F06-OP1.2]

Acceptable Solutions	Objectives and Functional Statements
(4)	(a), (b) [F06, F12-OS1.2] [F03, F05, F06, F10, F12-OS1.5] (a), (b) [F03, F06, F12-OP1.2] (c) [F03, F06-OS1.2] [F03, F05, F06-OS1.5] (c) [F03, F06-OP1.2]
(5)	[F13-OP1.2] [F13, F82-OS1.5, OS1.2]
3.3.1.5.	Egress Doorways
(1)	[F10, F05-OS1.5]
(2)	[F10, F05-OS1.5]
(3)	[F05, F10-OS1.2]
(4)	
(5)	[F10-OS1.5]
3.3.1.6.	Travel Distance
(1)	[F10-OS1.5]
3.3.1.7.	Protection on Floor Areas with a Barrier-Free Path of Travel
(1)	[F05, F10-OS1.5] (a) [F06-OS1.5]
(2)	[F05, F10-OS1.5]
(3)	[F02-OP1.2] [F02-OS1.2]
(4)	[F03-OS1.2] [F06-OS1.5]
(5)	
(6)	[F03-OS1.2] [F06-OS1.5]
(7)	(a), (b) [F10, F73-OS1.5] (c), (d) [F10-OS1.5]
3.3.1.8.	Headroom Clearance
(1)	
3.3.1.9.	Corridors
(1)	[F10, F12-OS3.7]
(2)	[F10, F12-OS3.7]
(3)	[F30, F73-OS3.1]
(4)	
(5)	[F10, F12-OS3.7]
(6)	(a) [F10, F12-OS3.7] (b) [F06-OS1.2] [F05, F06-OS1.5]
(7)	
(8)	[F10-OS3.7]
(9)	[F10-OS3.7]
(10)	[F10-OS1.5]
(11) to (13)	[F10-OS1.5] [F10-OS3.7]
(14)	[F10-OS3.7]
(15)	
3.3.1.10.	Door Swing
(1)	[F10-OS3.7]
(2)	[F10-OS3.7]
(3)	[F10-OS3.7]
(4)	[F10-OS3.7]
(5)	
3.3.1.11.	Sliding Doors
(1)	(b) [F10-OS3.7]
(2)	
(3)	

E6.1

F11.1

	Acceptable Solutions	Objectives and Functional Statements
	3.3.1.12.	Doors and Door Hardware
r11.1	(1)	(a), (b) [F10, F12-OS3.7] (c) [F30-OS3.1] [F10-OS3.7] (d) [F10-OS3.7]
	(2)	[F10-OS3.7]
	(3)	[F10-OS3.7]
	(4)	[F10-OS3.7]
	(5)	[F10-OS3.7] [F73-OA1]
	(6)	
	(7)	[F12-OS3.7]
	(8)	[F12-OS3.7]
	(9)	[F12-OS3.7]
	(10)	
	(11)	
	3.3.1.13.	Ramps and Stairways
	(1)	
	(2)	
	3.3.1.14.	Exterior Passageways
	(1)	
r11.2	3.3.1.15.	Tapered Treads in a Curved Flight
	(1)	
	(2) to (4)	[F30-OS3.1] [F10-OS3.7]
	3.3.1.16.	Capacity of Access to Exits
	(1)	
	(2)	[F10-OS3.7]
	(3)	[F10-OS3.7]
	(4)	
	(5)	
r11.1	(6)	[F10-OS3.7]
	3.3.1.17.	Guards
	(1)	[F30-OS3.1]
	(2)	[F30-OS3.1]
	(3)	
	(4)	[F30-OS3.1]
	(5)	[F30-OS3.1]
	(6)	
	3.3.1.18.	Transparent Doors and Panels
	(1)	[F30-OS3.1] [F10-OS3.7]
r11.1	(1.1)	[F30-OS3.1] [F10-OS3.7]
	(2)	[F20-OS3.1]
	(3)	[F30-OS3.1] [F10-OS3.7]
	(4)	
r11.1	(4.1)	[F30-OS3.1][F10-OS3.7]
	(5)	
	(6)	[F30-OS3.1]
r11.1	3.3.1.19.	Exhaust Ventilation and Explosion Venting
	(1)	[F01-OS1.1]
	(2)	[F02-OP1.2] [F02-OS1.2]
	(3)	
	(4)	[F02-OP1.3] Applies to the requirement for explosion-relief devices and vents. [F02-OS1.3] Applies to the requirement for explosion-relief devices and vents.

Acceptable Solutions	Objectives and Functional Statements
3.3.1.20.	Janitors' Rooms
(1)	[F03-OP1.2]
	[F03-OS1.2]
(2)	
(3)	[F02-OP1.2]
	[F02-OS1.2]
3.3.1.21.	Common Laundry Rooms
(1)	[F03-OP1.2]
	[F03-OS1.2]
(2)	
(3)	[F02-OP1.2]
	[F02-OS1.2]
3.3.1.22.	Obstructions
(1)	[F10-OS3.7]
3.3.1.23.	Signs in Service Spaces
(1)	[F10-OS3.7]
3.3.1.24.	Welding and Cutting
(1)	[F02, F03-OP1.2]
	[F02, F03-OS1.2]
(2)	
3.3.2.1.	Scope
(1)	
3.3.2.2.	Fire Separations
(1)	[F03-OS1.2]
(2)	
(3)	[F03-OS1.2] Applies where space under tiers of seats is <i>sprinklered</i> .
	[F03-OS1.2] Applies where space under tiers of seats is not <i>sprinklered</i> .
(4)	[F03-OS1.2]
	[F03-OP1.2]
(5)	[F03-OS1.2]
	[F03-OP1.2]
(6)	
(7)	[F03-OS1.2]
	[F03-OP1.2]
(8)	[F03-OS1.2]
(9)	[F03-OS1.2]
	[F03-OP1.2]
3.3.2.3.	Fixed Seats
(1)	[F30-OS3.1] [F10-OS3.7]
(2)	
(3)	[F10-OS3.7]
(4)	
(5)	
(6)	
3.3.2.4.	Aisles
(1)	
(2)	
(3)	[F10-OS3.7]
(4)	[F10-OS3.7]
(5)	[F10-OS3.7]
(6)	
E6.1 (7) to (10)	[F10-OS3.7]

Acceptable Solutions	Objectives and Functional Statements
(11)	[F10-OS3.7]
(12)	[F10-OS3.7]
(13)	[F03-OS1.2] [F10-OS3.7]
(14)	[F03-OS1.2] [F10-OS3.7]
(15)	[F10-OS3.7]
(16)	[F10-OS3.7]
(17)	[F10-OS3.7]
(18)	[F30-OS3.1] [F10-OS3.7]
(19)	[F30-OS3.1] [F10-OS3.7]
(20)	[F30-OS3.1] [F10-OS3.7]
(21)	[F30-OS3.1] [F10-OS3.7]
(22)	[F30-OS3.1] [F10-OS3.7]
(23)	[F30-OS3.1] [F10-OS3.7]
(24)	[F30-OS3.1] [F10-OS3.7]
(25)	[F30-OS3.1] [F10-OS3.7]
(26)	[F30-OS3.1] [F10-OS3.7]
(27)	
3.3.2.5.	Corridors
(1)	[F06-OS1.2] [F03, F05, F06-OS1.5] [F03, F06-OP1.2]
(2)	
(3)	[F06-OS1.2] [F03, F05, F06-OS1.5] [F03, F06-OP1.2]
(4)	[F10-OS3.7]
3.3.2.6.	Doors
(1)	[F10-OS3.7]
3.3.2.7.	Fixed Bench-Type Seats without Arms
(1)	[F10-OS3.7] [F10-OS3.7]
(2)	
(3)	
3.3.2.8.	Guards
(1)	
(2)	
(3)	
(4)	
3.3.2.8A.	Handrails in Aisles with Steps
(1), (2)	[F30-OS3.1] [F10-OS3.7]
3.3.2.9.	Outdoor Places of Assembly
(1)	[F10-OS3.7]
(2)	[F10-OS3.7]
(3)	[F10-OS3.7]
(4)	
(5)	[F10-OS3.7]
3.3.2.10.	Bleachers
(1)	[F30-OS3.1] [F10-OS3.7]
(2)	[F30-OS3.1] [F10-OS3.7]
(3)	
(4)	[F30-OS3.1] [F10-OS3.7]
(5)	[F30-OS3.1]

F11.2

Acceptable Solutions	Objectives and Functional Statements
3.3.2.11.	Libraries
(1)	[F03-OP1.2] [F03-OS1.2]
(2)	[F02-OP1.2] [F02-OS1.2]
(3)	
3.3.2.12.	Stages for Theatrical Performances
(1)	[F02-OP1.2] [F02-OS1.2]
(2)	[F03-OP1.2] [F03-OS1.2]
(3)	[F03-OP1.2] [F03-OS1.2]
(4)	[F03-OP1.2] [F03-OS1.2]
(5)	[F02, F06-OS1.2] [F06-OS1.5] [F02, F06-OP1.2]
(6)	[F03-OP1.2] [F03-OS1.2, OS1.5]
3.3.2.13.	Risers for Stairs
(1)	[F30-OS3.1]
3.3.2.14.	Storage Rooms
(1)	[F12-OP1.2] [F12-OS1.2]
3.3.3.1.	Scope
(1)	
3.3.3.2.	Fire Separations
(1)	[F03-OS1.2] [F44-OS3.4]
(2)	[F03-OS1.2] [F03-OP1.2]
(3)	[F03-OS1.5] [F03-OP1.2]
(4)	
(5)	
3.3.3.3.	Corridors
(1)	[F10-OS3.7]
(2)	[F10, F12-OS3.7]
(3)	[F10-OS1.5] [F10, F12-OS3.7]
(4)	(a) [F10-OS3.7] (b) [F10, F12-OS3.7]
(5)	
3.3.3.4.	Doorway Width
(1)	[F10, F12-OS3.7]
3.3.3.5.	Hospitals and Nursing Homes
(1)	
(2)	[F06-OS1.2] [F05, F06-OS1.5] [F06-OP1.2]
(3)	
(4)	[F03, F06-OP1.2] [F05, F06-OS1.2] [F06-OS1.5]

Acceptable Solutions	Objectives and Functional Statements
(5)	
F11.1	(6)
(7)	[F10-OS1.5]
(8)	[F10-OS1.5]
(9)	[F03, F05-OS1.2] [F06-OS1.5]
(10)	
(11)	
(12)	[F03, F05-OS1.2] [F06-OS1.5]
3.3.3.6.	Protection for Special Care and Treatment Facilities
(1)	[F03-OS1.2]
3.3.3.7.	Contained Use Areas
(1)	
(2)	[F03, F06-OS1.2] [F06-OS1.5]
	[F03, F06-OP1.2]
(3)	[F02, F06-OS1.2] [F06-OS1.5]
	[F02, F06-OP1.2]
(4)	[F02, F06-OS1.2] [F06-OS1.5]
	[F02, F06-OP1.2]
(5)	[F10-OS3.7]
3.3.3.8.	Handrails
(1)	[F30-OS3.1]
	[F73-OA1]
3.3.4.1.	Scope
(1)	
3.3.4.2.	Fire Separations
(1)	[F03, F06-OS1.2] [F05, F06-OS1.5]
	[F03, F06-OP1.2]
(2)	
(3)	
(4)	[F44-OS1.1] [F02, F03-OS1.2]
	(a), (b) [F02, F03-OP1.2]
(5)	[F01-OS1.1] [F03-OS1.2]
	[F44-OS3.4]
	(a) [F03-OP1.2]
3.3.4.3.	Storage Rooms
(1)	[F02-OP1.2]
	[F02-OS1.2]
(2)	[F03-OP1.2]
	[F03-OS1.2]
(3)	
(4)	[F12-OP1.2]
	[F12-OS1.2]
3.3.4.4.	Egress from Dwelling Units
(1)	
(2)	[F05, F10-OS3.7]
(3)	[F10-OS3.7]
(4)	[F05-OS1.2, OS1.5]
(5)	[F05, F10-OS3.7]
(6)	[F05, F10-OS3.7]

Acceptable Solutions	Objectives and Functional Statements
(7)	[F05, F10-OS3.7]
(8)	[F05-OS1.2] [F10-OS3.7]
(9)	[F05, F10-OS3.7]
3.3.4.5.	Automatic Locking Prohibition
(1)	[F10-OS3.7]
3.3.4.6.	Sound Transmission
(1)	
3.3.4.7.	Stairs, Handrails and Guards for Dwelling Units
(1)	
(2)	
3.3.4.8.	Window Protection
(1)	[F30-OS3.1]
(2)	
3.3.4.9.	Stud Wall Reinforcement
(1)	[F74-OA2]
3.3.4.10.	Resistance to Forced Entry
(1)	[F4.1-OS3.1]
3.3.4.11.	Retirement Homes
(1)	
(2)	[F06-OS1.2] [F05, F06-OS1.5] [F06-OP1.2]
(3)	
(4)	[F03, F06-OP1.2] [F05, F06-OS1.2] [F06-OS1.5]
(5)	
(6)	[F05-OS1.2] [F06-OS1.5]
(7)	[F10-OS1.5]
(8)	[F10-OS1.5]
(9)	[F03-OS1.2] [F03-OP1.2]
(10)	[F10-OS3.7]
(11)	[F10, F12-OS3.7]
(12)	[F11, F12-OS3.7]
3.3.5.1.	Scope
(1)	
3.3.5.2.	Fire Extinguishing Systems
(1)	[F03-OP1.2] [F03-OS1.2]
3.3.5.3.	Basements
(1)	[F12-OP1.2] [F01-OS1.1] [F12-OS1.2, OS1.5]
(2)	[F06-OS1.2] [F05, F06-OS1.5.] Applies to the separation of <i>exits</i> from the remainder of the <i>building</i> . [F06-OS1.2, OS1.5] Applies to the separation of entrances to <i>basements</i> and to rooms containing <i>building</i> services from the remainder of the <i>building</i> . [F06-OP1.2] Applies to the separation of <i>exits</i> from the remainder of the <i>building</i> . [F06-OP1.2] Applies to the separation of entrances from the remainder of the <i>building</i> .
(3)	[F44-OS1.1]

r6

Acceptable Solutions	Objectives and Functional Statements	
3.3.5.4.	Repair and Storage Garages	
(1)		
(2)	[F30-OS3.1] [F10, F12-OS3.7]	
(3)		
(4)		
(5)	[F30-OS3.1]	
(6)	[F30-OS3.1]	
F11.2	(6.1)	
	(7)	[F02-OP1.2]
	[F02-OS1.2]	
(8)		
3.3.5.5.	Repair Garage Separation	
(1)	[F03-OP1.2]	
	[F03-OS1.2]	
3.3.5.6.	Storage Garage Separation	
(1)	[F03-OP1.2]	
	[F03-OS1.2]	
3.3.5.7.	Vestibules	
(1)		
(2)		
(3)	[F44-OS1.1]	
	[F44-OS3.4]	

This Page
Intentionally Left Blank

	Acceptable Solutions	Objectives and Functional Statements
	3.3.5.8.	Toe-Boards Required
	(1)	[F30-OS3.1]
F11.2	3.3.5.9.	Guards
	(1)	
	3.3.6.1.	Application
	(1)	
F11.1	3.3.6.2.	Storage of Dangerous Goods
	(1)	[F03-OS1.2] [F03-OP1.2]
	(2)	[F03-OS1.2] [F03-OP1.2]
	(3)	[F01, F02, F03, F81-OS1.1, OS1.2] [F01, F02, F03, F81-OP1.1, OP1.2]
	3.3.6.3.	Indoor Storage of Compressed Gases
	(1)	(a) [F03-OS1.2] [F44-OS1.1] (a) [F03-OP1.2] (a) [F44-OS1.2, OS1.5, OS1.1] Applies to gas-tight fire separations. (b) [F12-OS1.2] [F01-OS1.1] [F02-OS1.3] (b) [F02-OP1.3] (c) [F12-OS1.1] (e) [F02-OS1.1] (e) [F02-OP1.1] (f) (g) [F01-OS1.1] (f) (g) [F01-OP1.1]
	(2)	[F44-OS1.1]
	(3)	(a) [F03-OS1.2] [F44-OS1.1] (a) [F03-OP1.2] (a) [F44-OS1.2, OS1.5, OS1.1] Applies to gas-tight fire separations. (b) [F12-OS1.2] [F02-OS1.3] (b) [F02-OP1.3]
	(4)	[F44-OS1.1] [F44-OP1.1] [F50-OH1.1]
	(5)	[F44, F01-OS1.1] [F44, F01-OP1.1]
	(6)	
	(7)	
	3.3.6.4.	Storage and Dispensing Rooms for Flammable Liquids and Combustible Liquids
	(1)	[F03-OS1.2] [F03-OP1.2]
	(2)	[F02-OS1.3] [F02-OP1.3]
	(3)	
	(4)	[F02-OS1.3] [F02-OP1.3]
	(5)	
	(6)	[F10-OS1.5]
	(7)	[F05, F10-OS1.5]
	(8)	[F10-OS1.5]
	3.3.6.5.	Tire Storage
	(1)	[F03-OS1.2] [F03-OP1.2]

Acceptable Solutions	Objectives and Functional Statements
3.3.6.6.	Ammonium Nitrate Storage
(1)	(a) [F01-OS1.1] [F02,F12-OS1.2]
	(a) [F01-OP1.1] [F02,F12-OP1.2]
	(b) (c) [F03-OS1.2][F01-OS1.1]
	(b) (c) [F03-OP1.2][F01-OP1.1]
	(c) [F44-OH5]
	(d) [F01-OS1.1][F02-OS1.2]
	(d) [F43-OS3.4]
	(e) [F01,F81-OS1.1]
	(f) [F12,F02-OS1.1]
	(f) [F12,F02-OP1.2]
3.3.6.7.	Flooring Material
(1)	[F43-OS3.4]
	[F44-OH5]
	[F01-OS1.1]
3.3.6.8.	Fire Separations in Process Plants
(1)	[F03-OP1.2]
	[F03-OS1.2]
3.3.6.9.	Basements and Pits
(1)	[F01-OS1.1]
	[F01-OP1.1]
3.4.1.1.	Scope
(1)	
3.4.1.2.	Separation of Exits
(1)	[F05, F06, F10, F12-OS3.7]
	[F06, F12-OP1.2]
	[F06, F12-OS1.2, OS1.5]
(2)	[F10-OS3.7]
3.4.1.3.	Access to Exits
(1)	
3.4.1.4.	Types of Exit
(1)	
3.4.1.5.	Exterior Exit Passageways
(1)	[F10-OS3.7]
(2)	
3.4.1.6.	Restricted Use of Horizontal Exits
(1)	[F10-OS3.7]
(2)	[F05, F10-OS3.7]
(3)	
3.4.1.7.	Slide Escapes
(1)	[F10-OS3.7]
3.4.1.8.	Transparent Doors and Panels
(1)	
3.4.1.9.	Mirrors near Exits
(1)	[F30-OS3.1] [F10-OS3.7]
3.4.1.10.	Combustible Glazing in Exits
(1)	[F03, F06-OP1.2]
	[F05, F06-OS1.2] [F06-OS1.5]
3.4.1.11.	Exterior Stairway for Nursing Home
(1)	[F10-OS3.1, OS3.7]

Acceptable Solutions	Objectives and Functional Statements
3.4.2.1.	Minimum Number of Exits
(1)	[F05, F06, F10, F12-OS3.7]
	[F06, F12-OP1.2]
	[F06, F12-OS1.2]
(2)	
(3)	[F10-OS3.7]
(4)	
(5)	
(6)	[F10-OS3.7]
(7)	
3.4.2.2.	Mezzanine Exiting
(1)	[F05-OS1.5]
(2)	
(3)	
(4)	
3.4.2.3.	Distance Between Exits
(1)	[F05, F10-OS1.5]
(2)	
(3)	
F11.1 (4)	[F10-OS3.7]
3.4.2.4.	Travel Distance
(1)	
(2)	
(3)	[F10-OS3.7]
(4)	
3.4.2.5.	Location of Exits
(1)	[F10-OS3.7]
(2)	
(3)	[F10-OS3.7]
3.4.2.6.	Principal Entrance
(1)	[F10-OS3.7]
F11.1 (2)	[F10-OS3.7]
3.4.3.1.	Exit Width Based on Occupant Load
(1)	
(2)	[F10-OS3.7]
3.4.3.2.	Exit Width
(1)	[F10-OS3.7]
(2)	[F10-OS3.7]
(3)	[F10-OS3.7]
(4)	
(5)	
(6)	[F10-OS3.7]
(7)	[F12-OP1.2]
	[F12-OS1.2]
	[F30-OS3.1] [F10, F12-OS3.7]
3.4.3.3.	Exits from Interconnected Floor Space
(1)	
3.4.3.4.	Exit Width Reduction
(1)	[F12-OS1.2]
	[F30-OS3.1] [F10, F12-OS3.7]
	[F12-OP1.2]

Acceptable Solutions	Objectives and Functional Statements
e6.1	(2) to (5)
	[F12-OS1.2]
	[F10, F12-OS3.7]
	[F12-OP1.2]
	3.4.3.5. Headroom Clearance
	(1)
	[F12-OP1.2]
	[F12-OS1.2]
	[F30-OS3.1] [F10, F12-OS3.7]
	(2)
	(3)
	(4)
	[F12-OP1.2]
	[F12-OS1.2]
	[F30-OS3.1] [F10, F12-OS3.7]
	(5)
	[F12-OP1.2]
	[F12-OS1.2]
	[F30-OS3.1] [F10, F12-OS3.7]
	3.4.4.1. Fire-Resistance Rating of Exit Separations
	(1)
	[F03, F06-OS1.2] [F05, F06-OS1.5]
	[F03, F06-OP1.2]
	(2)
r5	(3)
r5	(4)
r5	(5)
	3.4.4.2. Exits Through Lobbies
	(1)
	[F05, F06-OS1.5]
	(2)
	[F05, F06, F10, F12-OS1.5]
	3.4.4.3. Exterior Passageway Exceptions
	(1)
	[F05, F06, F10-OS1.5]
	3.4.4.4. Integrity of Exits
	(1)
	[F03, F06-OS1.2] [F05, F06-OS1.5]
	[F03, F06-OP1.2]
	(2)
	[F06-OS1.2] [F05, F06-OS1.5]
	[F06-OP1.2]
	(3)
	[F06-OS1.2] [F05, F06-OS1.5]
	[F06-OP1.2]
	(4)
	[F06-OS1.2] [F05, F06-OS1.5]
	[F43-OS3.7]
	[F06-OP1.2]
	(5)
	[F03, F06-OP1.2]
	[F03, F06-OS1.2] [F05, F06-OS1.5]
	(6)
	[F12-OS1.2] [F05, F10, F12-OS1.5]
	[F30-OS3.1] [F31-OS3.2] [F32-OS3.3] [F43-OS3.4] [F10, F12-OS3.7]
	[F12-OP1.2]
	(7)
	[F06-OS1.2] [F05, F06-OS1.5]
	[F06-OP1.2]
	[F43-OS3.7]
	(8)
	[F06-OS1.2] [F05, F06-OS1.5]
	[F06-OP1.2]
	(9)
	[F06-OS1.2] [F05, F06-OS1.5]
	[F06-OP1.2]
	(10)
	[F81-OS1.5]
	[F81-OS3.7]
	[F81-OP1.2]

	Acceptable Solutions	Objectives and Functional Statements
	3.4.5.1.	Exit Signage
	(1)	[F10-OS3.7]
	(2)	[F10-OS3.7]
	(3)	[F10,F81-OS3.7]
	(4)	[F10, F81-OS3.7]
e6.1	(5) to (9)	[F10-OS3.7]
	(10)	
	3.4.5.2.	Signs within Exit Facilities
	(1)	[F10-OS3.7]
	(2)	[F10-OS3.7]
r4	3.4.6.1.	Surface Finish of Ramps and Stairs
	(1)	(a), (b) [F30-OS3.1] [F10-OS3.7]
r5	(2)	[F73-OA1]
	(3)	[F12-OS1.2, OS1.5] [F30-OS3.1] [F10, F12-OS3.7] [F12-OP1.2]
	3.4.6.2.	Minimum Number of Risers
	(1)	[F30-OS3.1]
	3.4.6.3.	Maximum Vertical Rise of Stair Flights and Required Landings
	(1)	[F10-OS3.7]
	(2)	[F10-OS3.7] [F30-OS3.1]
	(3)	
r11.2	3.4.6.4.	Dimensions of Landings
	(1), (2)	[F30-OS3.1] [F10, F12-OS3.7] [F12-OP1.2] [F12-OS1.2, OS1.5]
	(3)	
	(4)	[F30-OS3.1] [F10, F12-OS3.7]
	(5)	[F30-OS3.1] [F10, F12-OS3.7]
	(6)	
r11.2	3.4.6.5.	Handrails
	(1) to (5)	[F30-OS3.1] [F10-OS3.7]
	(6)	
	(7)	[F30-OS3.1] [F10-OS3.7]
	(8)	
	(9)	[F30-OS3.1] [F10-OS3.7]
	(10)	[F30-OS3.1] [F10-OS3.7] [F73-OA1]
	(11)	[F30-OS3.1] [F10-OS3.7]
	(12)	[F30-OS3.1] [F10-OS3.7] [F73-OA1]
	(13)	[F30-OS3.1] [F10-OS3.7]
	(14)	
	(15)	[F30-OS3.1] [F10-OS3.7]
	(16)	[F30-OS3.1] [F10-OS3.7] [F73-OA1]
	3.4.6.6.	Guards
	(1)	[F30-OS3.1] [F10-OS3.7]
	(2)	[F30-OS3.1] [F10-OS3.7]
	(3)	[F30-OS3.1] [F10-OS3.7]
r11.2	(4)	[F30-OS3.1] [F10-OS3.7]
	(5)	[F30-OS3.1]

Acceptable Solutions	Objectives and Functional Statements
(6)	
(7)	[F30-OS3.1]
(8)	[F30-OS3.1]
3.4.6.7.	Ramp Slope
(1)	[F30-OS3.1] [F10-OS3.7]
3.4.6.8.	Treads and Risers
(1)	[F30-OS3.1] [F10-OS3.7]
(2)	[F30-OS3.1] [F10-OS3.7]
R11.2	(2.1)
	[F30-OS3.1] [F10-OS3.7]
	[F73-OA1]
(3)	[F30-OS3.1] [F10-OS3.7]
(4)	[F30-OS3.1] [F10-OS3.7]
R11.2	(5)
(6)	[F30-OS3.1] [F10-OS3.7]
(7)	[F30-OS3.1]
(8)	[F30-OS3.1]
(9)	[F10-OS3.7][F30-OS3.1]
(10)	[F30-OS3.1]
R11.2	3.4.6.9.
	Curved Flights in Exits
(1) to (4)	[F30-OS3.1] [F10-OS3.7]
3.4.6.10.	Horizontal Exits
(1)	[F10-OS3.7]
(2)	[F10-OS3.7]
(3)	
(4)	[F10, F73-OS3.7]
(5)	[F10-OS3.7]
(6)	
(7)	[F10-OS1.5]
3.4.6.11.	Doors
(1)	[F30-OS3.1] [F10-OS3.7]
R11.1	(1.1)
	[F30-OS3.1] [F10-OS3.7]
(2)	[F30-OS3.1] [F10-OS3.7] Applies to portion of Code text: "No exit door shall open directly onto a step..."
	[F10, F81-OS3.7] Applies where there is a danger of blockage from ice or snow.
(3)	[F10-OS3.7]
R11.1	(4)
	[F10, F12-OS3.7]
(5)	[F10-OS3.7]
3.4.6.12.	Direction of Door Swing
(1)	[F10-OS3.7]
(2)	[F10-OS3.7]
(3)	
R11.1	(4)
3.4.6.13.	Self-Closing Devices
(1)	[F06-OS1.2] [F05, F06-OS1.5]
	[F03, F06-OP1.2]
3.4.6.14.	Sliding Doors
(1)	
(2)	[F12-OS3.7]
3.4.6.15.	Revolving Doors
(1)	(a) [F30-OS3.1] [F10-OS3.7]
	(b) [F10, F12-OS3.7]
	(c) [F10-OS3.7]
	(d) [F30-OS3.1] [F10-OS3.7]
	(e) [F20-OS3.1]

Acceptable Solutions	Objectives and Functional Statements
(2)	[F10-OS3.7]
(3)	(a), (b), (d), (e) [F20, F30-OS3.1] [F10, F81-OS3.7]
3.4.6.16.	Door Release Hardware
(1)	[F10-OS3.7]
(2)	[F10-OS3.7]
(3)	[F10-OS3.7]
(4)	[F10, F81-OS3.7]
(4)	[F10, F81-OS3.7]
(5)	[F10-OS3.7]
(6)	
(7)	[F02-OS1.2]
(7)	[F10-OS3.7]
(8)	[F10-OS3.7]
(8)	[F73-OA1]
3.4.6.17.	Reserved
R11.1	3.4.6.18. Emergency Crossover Access to Floor Areas
(1)	[F10-OS3.7]
(2)	
(3)	[F10-OS3.7]
(4)	[F10, F12-OS3.7]
(4)	[F12-OP1.2]
(4)	[F12-OS1.2, OS1.5]
(5)	[F10-OS3.7]
(6)	
3.4.6.19.	Floor Numbering
(1)	[F12-OS1.2]
(1)	[F10, F12, F73-OS3.7]
(1)	[F12-OP1.2]
(1)	[F73-OA1]
(2)	[F12-OS1.2]
(2)	[F10, F12, F73-OS3.7]
(2)	[F12-OP1.2]
(2)	[F73-OA1]
3.4.7.1.	Scope
(1)	[F10, F12-OS3.7]
(2)	[F12-OS1.2] [F10-OS1.5]
(2)	[F30-OS3.1] [F10-OS3.7]
3.4.7.2.	Fire Escape Construction
(1)	[F06-OS1.2] [F05-OS1.5] Applies to the combustibility of materials used in the construction of fire escapes.
(1)	[F20-OS3.1] [F10, F12-OS3.7] Applies to the type and construction of fire escapes.
(1)	[F20-OS2.1] Applies to the type and construction of fire escapes.
3.4.7.3.	Access to Fire Escapes
(1)	[F10-OS3.7] Applies to portion of Code text: "Access to fire escapes shall be from corridors through doors at floor level..."
(2)	[F30-OS3.1] [F10-OS3.7]
3.4.7.4.	Protection of Fire Escapes
(1)	[F05, F06-OS1.5]
(2)	
3.4.7.5.	Stairs
(1)	[F10-OS3.7]
(2)	[F10-OS3.7]
(3)	[F10-OS3.7] Applies to the reduction in width permitted under certain conditions.

Acceptable Solutions	Objectives and Functional Statements
(4)	[F30-OS3.1] [F10-OS3.7]
3.4.7.6.	Guards and Railings
(1)	[F30-OS3.1] [F10-OS3.7]
(2)	[F30-OS3.1] [F10-OS3.7]
(3)	[F30-OS3.1] [F10-OS3.7]
(4)	[F30-OS3.1]
(5)	[F30-OS3.1]
3.4.7.7.	Landings
(1)	
3.5.1.1.	Scope
(1)	
(2)	
3.5.2.1.	Required Elevator
(1)	[F12-OS3.7] [F73-OA1]
3.5.2.2.	Barrier-Free Design
(1)	[F73-OA1]
3.5.3.1.	Fire Separations for Elevator Hoistways
(1)	[F03-OP1.2] [F03-OS1.2]
(2)	
(3)	[F06-OP1.2] [F06-OS1.2] [F05, F06-OS1.5]
3.5.3.2.	Vertical Service Spaces for Dumbwaiters
(1)	[F03-OP1.2] [F03-OS1.2]
3.5.3.3.	Fire Separations for Elevator Machine Rooms
(1)	[F03-OP1.2] [F03-OS1.2]
(2)	[F03-OP1.2] [F03-OS1.2]
3.5.4.1.	Elevator Car Dimensions
(1)	[F12-OS3.7]
(2)	[F12-OS3.7]
3.6.1.1.	Scope
(1)	
(2)	
3.6.1.2.	Reserved
3.6.1.3.	Storage Use Prohibition
(1)	[F01-OS1.1] [F02-OS1.2]
3.6.1.4.	Reserved
3.6.1.5.	Fixed Access Ladders
(1)	[F20-OS2.1] [F30-OS3.1]
3.6.2.1.	Fire Separations around Service Rooms
(1)	[F03-OP1.2, OP1.4] [F03-OS1.2, OS1.4]
(2)	
(3)	[F01-OP1.1] [F03-OP1.2] [F01-OS1.1] [F03-OS1.2]

Acceptable Solutions	Objectives and Functional Statements
(4)	[F03-OP1.2, OP1.4] [F03-OS1.2, OS1.4]
(5)	[F03-OP1.2, OP1.4] [F03-OS1.2, OS1.4]
(6)	[F03-OP1.2, OP1.4] [F03-OS1.2, OS1.4]
(7)	[F03-OP1.2, OP1.4] [F03-OS1.2, OS1.4]
(8)	
(9)	
(10)	
(11)	
3.6.2.2.	Service Rooms under Exits
(1)	[F02-OS1.2] [F05, F06-OS3.7]
3.6.2.3.	Service Equipment
(1)	
3.6.2.4.	Incinerator Rooms
(1)	[F02-OS1.2]
3.6.2.5.	Combustible Refuse Storage
(1)	[F03-OP1.2] [F03-OS1.2]
3.6.2.6.	Door Swing for Service Rooms
(1)	[F10-OS1.5] Applies to portion of Code text: "A swing-type door from a <i>service room</i> containing a <i>boiler</i> or incinerator shall swing outward from the room ..." [F30-OS3.1] Applies to portion of Code text: "A swing-type door from a <i>service room</i> containing a <i>boiler</i> or incinerator shall swing ... inward if the door opens onto a corridor or any room used for an <i>assembly occupancy</i> ."
3.6.2.7.	Electrical Equipment Vaults
(1)	[F03-OP1.2, OP1.4] [F03-OS1.2, OS1.4]
(2)	[F02-OP1.2] [F03-OP1.4] [F02-OS1.2] [F03-OS1.4] [F11-OS1.5]
(3)	[F02, F04-OS1.3] [F02, F04-OP1.3]
(4)	[F02, F04-OS1.3] [F02, F04-OP1.3]
(5)	[F03-OP1.2, OP1.4] [F03-OS1.2, OS1.4]
(6)	
(7)	[F32-OS3.3] [F34-OS4.1]
(8)	[F02-OS1.2, OS1.3] [F02-OP1.2, OP1.3]
(9)	[F81-OS1.1]
(10)	[F81-OS1.1]
(11)	[F81-OS1.1]
(12)	[F81-OS1.1] (b) [F30-OS3.1] (d) [F03-OS1.2] (d) [F03-OP1.2]

Acceptable Solutions	Objectives and Functional Statements
(13)	[F81-OS1.1] [F34-OS3.3] [F81-OP1.1]
(14)	[F01-OS1.1] [F03-OS1.2] [F01-OP1.1] [F03-OP1.2]
(15)	[F01-OS1.1] [F03-OS1.2] [F01-OP1.1] [F03-OP1.2]
(16)	[F02-OS1.1 OS1.3] [F02-OP1.1, OP1.3]
(17)	[F01-OS1.1] [F01-OP1.1]
(18)	(a) [F30-OS3.1][F10-OS3.7] (b) (c) [F32-OS3.3]
3.6.2.8.	Emergency Power Installations
(1)	[F03, F06-OS1.2] [F03-OS1.4] [F06-OS1.5] [F03, F06-OP1.2] [F03-OP1.4]
3.6.2.9.	Storage of Oxygen Containers
(1)	[F01-OS1.1] [F03-OS1.2] [F43-OS3.4] [F01-OP1.1] [F03-OP1.2]
3.6.3.1.	Fire Separations for Vertical Service Spaces
(1)	[F03-OP1.2] [F03-OS1.2]
(2)	[F03-OP1.2] [F03-OS1.2]
(3)	[F03-OP1.2] [F03-OS1.2]
(4)	[F03-OP1.2] [F03-OS1.2]
(5)	[F03-OP1.2] [F03-OS1.2]
3.6.3.2.	Foamed Plastic Protection
(1)	[F02-OS1.2]
3.6.3.3.	Linen and Refuse Chutes
(1)	(a), (b), (c) [F41-OH2.4, OH2.5] (d), (e) [F02-OS1.2]
(2)	[F03-OP1.2] [F03-OS1.2]
(3)	[F03-OS1.2]
(4)	(a) [F41-OH2.4, OH2.5] (b) [F03-OS1.2]
(5)	(a) [F03, F81-OP1.2] (a) [F03, F81-OS1.2] (a) [F41, F81-OH2.4, OH2.5] (b) [F03-OP1.2] (b) [F03-OS1.2] (c) [F01, F02-OP1.2] (c) [F01, F02-OS1.2] (d) [F06-OS1.2] [F05, F06-OS1.5] (d) [F06-OP1.2]
(6)	[F02-OP1.2] [F02-OS1.2]

Acceptable Solutions	Objectives and Functional Statements
(7)	[F03-OP1.2] [F03-OS1.2]
(8)	[F02-OS1.2] [F41-OH2.4, OH2.5]
(9)	[F03-OP1.2] [F03-OS1.2]
(10)	[F41-OH2.4, OH2.5] Applies to portion of Code text: "The room or bin into which a refuse chute discharges shall be ...impervious to moisture and be equipped with a water connection and floor drain for washing-down purposes:" [F03, F81-OS1.2] Applies to portion of Code text: "The room or bin into which a refuse chute discharges shall be of sufficient size to contain the refuse between normal intervals of emptying ..." [F41, F81-OH2.4, OH2.5] Applies to portion of Code text: "The room or bin into which a refuse chute discharges shall be of sufficient size to contain the refuse between normal intervals of emptying ..."
(11)	[F01, F02-OS1.2]
3.6.3.4.	Exhaust Duct Negative Pressure
(1)	
3.6.3.5.	Grease Duct Enclosures
(1)	[F02, F03-OS1.2] [F03, F02-OP1.2]
(2)	[F02, F03-OS1.2] [F03, F02-OP1.2]
3.6.4.1.	Scope
(1)	
3.6.4.2.	Fire Separations for Horizontal Service Spaces
(1)	
(2)	[F03-OP1.2] [F03-OS1.2]
3.6.4.3.	Plenum Requirements
(1)	[F02-OS1.2]
(2)	[F03-OP1.2, OP1.3] [F03-OS1.2, OS1.3]
(3)	[F43-OH5]
3.6.4.4.	Attic or Roof Space Access
(1)	[F01, F02, F12-OP1.2] [F01, F02, F12-OS1.2]
3.6.4.5.	Horizontal Service Space Access
(1)	[F01, F02, F12-OP1.2] [F01, F02, F12-OS1.2]
3.6.4.6.	Crawl Space Access
(1)	[F01, F02, F12-OP1.2] [F01, F02, F12-OS1.2]
3.7.1.1.	Room and Space Height
(1)	[F30-OS3.1]
(2)	
3.7.1.2.	Residential Room Dimensions
(1)	
3.7.1.3.	Sleeping Areas in Group B and Child Care Facilities
(1)	[F30-OS3.1]
(2)	[F30-OS3.1]
(3)	[F30-OS3.1]
3.7.1.4.	Sleeping Areas in Camps
(1)	[F30-OS3.1]
(2)	[F30-OS3.1]

Acceptable Solutions	Objectives and Functional Statements
3.7.2.1.	Window Areas
(1)	[F102-OH7]
(2)	[F102-OH7]
(3)	[F102-OH7]
3.7.3.	Reserved
3.7.4.1.	Plumbing and Drainage Systems
(1)	[F72-OH2.1] [F70-OH2.2] [F71-OH2.3]
(2)	[F72-OH2.1]
(3)	
3.7.4.2.	Plumbing Fixtures, General
(1)	
(2)	[F72-OH2.1] Applies to portion of Code text: "water closets shall be provided"
(3)	
(4)	
(5)	[F71-OH2.3]
(6)	
(7)	[F74-OA2]
(8)	
(9)	
(10)	[F30-OS3.1]
(11)	[F71-OH2.3]
3.7.4.3.	Plumbing Fixtures for Assembly Occupancies
(1)	[F72-OH2.1]
(2)	[F72-OH2.1]
(3)	[F72-OH2.1]
(4)	[F72-OH2.1]
(5)	[F72-OH2.1]
(6)	[F72-OH2.1] [F71-OH2.3]
(7)	[F72-OH2.1]
(8)	[F72-OH2.1] (b) [F101-OH6]
(9)	
(10)	[F72-OH2.1]
(11)	[F72-OH2.1]
(12) to (16)	[F72-OH2.1]
3.7.4.4.	Plumbing Fixtures for Care or Detention Occupancies
(1)	[F72-OH2.1] [F71-OH2.3]
(2)	[F72-OH2.1] [F71-OH2.3]
(3)	[F72-OH2.1]
3.7.4.5.	Plumbing Facilities for Dwelling Units
(1)	[F72-OH2.1] [F70-OH2.2] [F71-OH2.3]
3.7.4.6.	Plumbing Fixtures for Other Residential Occupancies
(1)	[F72-OH2.1]
(2)	[F72-OH2.1]
(3)	[F71-OH2.3]
(4)	[F50-OH1.1] [F71-OH2.3]
3.7.4.7.	Plumbing Fixtures for Business and Personal Services Occupancies
(1)	[F72-OH2.1]
(2)	
3.7.4.8.	Plumbing Fixtures for Mercantile Occupancies
(1)	[F72-OH2.1]

F4

F4

F4

E6.1

Acceptable Solutions	Objectives and Functional Statements
(2)	[F72-OH2.1]
(3)	
(4)	[F72-OH2.1] [F71-OH2.3]
3.7.4.9.	Plumbing Fixtures for Industrial Occupancies
(1)	[F72-OH2.1]
(2)	
3.7.4.10.	Plumbing Fixtures for Mobile Home Facilities
(1)	[F72-OH2.1] [F71-OH2.3]
(2)	[F72-OH2.1]
(3)	[F71-OH2.3] Applies to the minimum number of laundry trays or similar facilities, and of bathtubs or showers for each sex.
3.7.4.11.	Safety Glass
(1)	[F20-OS3.1]
3.7.4.12.	Surface Protection
(1)	[F72-OH2.1] [F40-OH2.4]
(2)	[F72-OH2.1] [F40-OH2.4]
3.7.4.13.	Floor Drains
(1)	[F30-OS3.1] [F40, F41-OH2.4, OH2.6]
3.7.4.14.	Grab Bar Installation
(1)	[F20-OS3.1]
3.7.4.15.	Clearances for Water Closets
(1)	[F30-OS3.1]
3.7.4.16.	Privacy
(1)	[F101-OH6]
(2)	[F101-OH6]
3.7.4.17.	Water Temperature Control
(1)	
3.7.4.18.	Drinking Water
(1)	[F70-OH2.2]
3.7.4.19.	Pharmacies
(1)	[F40-OH2.4]
3.7.5.1.	Electrical Systems
(1)	[F01-OS1.1] [F32-OS3.3] [F01-OP1.1]
3.7.5.2.	Medical Gas Piping
(1)	[F43, F81, F82-OS3.4] (b) [F01, F02-OS1.1] (b) [F01, F02-OP1.1]
3.7.5.3.	Shielding of X-Ray Equipment
(1)	[F44-OS3.4]
3.7.6.1.	Application
(1)	
3.7.6.2.	Room Finishes
(1)	[F41-OH2.4]
(2)	
(3)	[F41-OH2.4]
3.7.6.3.	Location of Plumbing Fixtures
(1)	[F40-OH2.1, OH2.4]
(2)	[F72-OH2.1] [F71-OH2.3]

F11.1

Acceptable Solutions	Objectives and Functional Statements
(3)	
3.7.6.4.	Lavatories, Appliances and Sinks
(1)	[F71-OH2.3]
(2)	[F40-OH2.4]
(3)	
3.7.6.5.	Hot and Cold Water Supply
(1)	(a) [F71-OH2.3] [F40-OH2.4]
	(b) [F70-OH2.2]
	(c) [F40-OH2.4]
(2)	
3.7.6.6.	Employee Facilities
(1)	[F41-OH2.4]
	[F101-OH6]
(2)	[F71-OH2.3]
3.7.6.7.	Sleeping Quarters
(1)	[F40-OH2.4]
3.8.1.1.	Application
(1)	
r4	3.8.1.2.
	Entrances
(1)	[F73-OA1]
(2)	
(3)	[F73-OA1]
(4)	
(5)	
(6)	[F73-OA1]
3.8.1.3.	Barrier-Free Path of Travel
(1)	[F73-OA1]
(2)	(a), (b) [F30-OS3.1]
	(a), (b) [F73-OA1]
	(c) [F30-OS3.1]
	(c) [F73-OA1]
	(d), (e) [F30-OS3.1]
	(d), (e) [F73-OA1]
(3)	[F73-OA1]
(4)	[F73-OA1]
(5)	[F30-OS3.1]
r4	(6)
	[F73-OA1]
r4	3.8.1.4.
	Escalators and Moving Walks
(1)	[F73-OA1]
(2)	[F73-OA1]
(3)	[F73-OA1]
3.8.1.5.	Controls
(1)	[F10-OS3.7]
	[F73-OA1]
	[F74-OA2]
(2)	[F74-OA2]
3.8.1.6.	Illumination
(1)	
r4	3.8.2.1.
	Areas Requiring Barrier-Free Path of Travel
(1)	[F73-OA1]
(2)	
(3)	

Acceptable Solutions	Objectives and Functional Statements
(4)	[F74-OA2]
(5)	[F73-OA1]
	[F74-OA2]
(6)	[F74-OA2]
(7)	
(8)	
3.8.2.2.	Access to Parking Areas
(1)	[F73-OA1]
(2)	[F73-OA1]
(3)	(a) [F74-OA2]
	(b) [F73-OA1]
	(c) [F74-OA2]
R4	3.8.2.3. Washrooms Required to be Barrier-Free
(1)	[F74-OA2]
(2)	[F72-OH2.1] [F71-OH2.3]
(3)	[F72-OH2.1] [F71-OH2.3]
(4)	
(5)	
(6)	[F72-OH2.1] [F71-OH2.3]
	[F74-OA2]
R4	3.8.2.4. Hotels
(1)	[F73-OA1]
	[F74-OA2]
(2)	
(3)	[F74-OA2]
(4)	[F74-OA2]
(5)	[F74-OA1]
(6)	[F74-OA1]
(7)	[F74-OA2]
(8)	[F73-OA1]

Acceptable Solutions	Objectives and Functional Statements	
(5)	[F73-OA1]	
r4	(6)	[F71-OH2.3]
		[F74-OA1]
(7)	[F73-OA1]	
(8)		
(9)	[F30-OS3.1]	
	[F73-OA1]	
(10)	[F73-OA1]	
(11)	[F30-OS3.1]	
	[F73-OA1]	
(12)		
(13)	[F73-OA1]	
(14)	[F30-OS3.1]	
(15)	[F30-OS3.1]	
(16)		
r4	(17)	[F73-OA1]
	(18)	[F30-OS3.1]
r4	(19)	[F73-OA1]
3.8.3.4. Ramps		
r4	(1)	(b), (c), (d), (e), (h) [F73-OA1]
		(b), (c), (d), (f), (g), (h) [F30-OS3.1]
		(e)(iii) [F30-OS3.1]
		(e)(v) [F30-OS3.1]
(2)		
(3)		
3.8.3.5. Passenger Elevating Devices		
(1)	[F30-OS3.1] [F10-OS3.7]	
r4	3.8.3.6. Wheelchair Spaces and Adaptive Seating	
	(1)	[F30-OS3.1] Applies to portion of Code text: "... level, or level with removable seats ..."
		[F74-OA2] Applies to entire Sentence except for portion of Code text: "... without infringing on egress from any row of seating or any aisle requirements ..."
		(d) [F10-OS3.7]
(2)	[F74-OA2]	
(3)	[F73-OA1]	
3.8.3.7. Assistive Listening Devices		
(1)	[F11-OS3.7]	
	[F74-OA2]	
r11.1	3.8.3.8. Water Closet Stalls and Enclosures	
	(1)	[F72-OH2.1]
		[F74-OA2]
		(c) [F101-OH6]
		(c)(i) [F74-OA2]
		(c)(vii) [F36-OS3.6]
		(e) [F30-OS3.1] Applies to portion of Code text: "... be equipped with a coat hook ... projecting not more than 50 mm from the wall ..."
	(2)	[F74-OA2]
(3)	[F72-OH2.1]	
	[F74-OA2]	
(4)	[F72-OH2.1]	
	[F74-OA2]	
(5)	[F30-OS3.1]	
	[F74-OA2]	

	Acceptable Solutions	Objectives and Functional Statements
	(6)	[F30-OS3.1] [F74-OA2]
	(7)	[F20-OS3.1] [F74-OA2]
	(8)	[F20-OS3.1] [F74-OA2]
	(9)	[F74-OA2]
	(10)	[F74-OA2] (b)(vi) [F36-OS3.6] (d) [F30-OS3.1]
R11.1	3.8.3.9.	Water Closets
	(1)	[F72-OH2.1] [F74-OA2]
R11.1	3.8.3.10.	Urinals
	(1)	[F74-OA2]
	(2)	[F74-OS2] (b) [F30-OS3.1]
	(3)	[F74-OA2] [F101-OH3.2]
	(4)	[F74-OA2]
R11.1	3.8.3.11.	Lavatories, Mirrors and Washroom Accessories
	(1)	[F71-OH2.3] [F74-OA2] (d) [F31-OS3.2]
	(2)	[F74-OA2]
	(3)	
R4	(4)	
R4	(5)	[F74-OA2]
R4	3.8.3.12.	Universal Washrooms
R11.1	(1)	[F72-OH2.1] [F71-OH2.3] [F74-OA2] (b) [F74-OA2] Applies to portion of Code text: "... b) ... a door that is capable of being locked from the inside ..." (b) [F10-OS3.7] (g) [F30-OS3.1] Applies to the requirement for a coat hook. (j) [F73-OA1] (k) [F131-OR2]
	(2)	[F36-OS3.6]
	(3)	
	(4)	[F20-OS3.1]
	(5)	[F74-OA2.1] [F71-OH2.3] (b) [F20-OS3.1]
	(6)	
R4	3.8.3.13.	Showers and Bathtubs
	(1)	[F74-OA2]
R11.1	(2)	[F74-OA2] (f)(iii) [F20-OS3.1]
R11.1	(2.1)	
	(3)	

	Acceptable Solutions	Objectives and Functional Statements
r11.1	(4)	[F74-OA2]
	(5)	[F74-OA2]
	3.8.3.14.	Reserved
	3.8.3.15.	Shelves or Counters for Telephones
	(1)	[F74-OA2]
	(2)	[F74-OA2]
	(3)	[F74-OA2]
r4	(4)	[F74-OA2]
r4	(5)	
r4	3.8.3.16.	Drinking Fountains
	(1)	[F74-OA2]
	(2)	[F74-OA2]
	(3)	[F74-OA2]
	(4)	
r4	3.8.3.17.	Platforms
	(1)	[F30-OS3.1]
	(2)	
r4	3.8.3.18.	Tactile Attention Indicators
	(1)	[F30-OS3.1]
r5	(2)	[F30-OS3.1]
	3.9.1.1.	Application
	(1)	
	3.9.1.2.	Heating Systems
	(1)	
	3.9.2.1.	Flame-Spread Rating
	(1)	[F02-OP1.2] [F02-OS1.2]
	3.9.3.1.	Building Areas
	(1)	[F02-OP1.1] [F02-OS1.1]
	(2)	
	3.9.3.2.	Spatial Separations
	(1)	[F03-OP3.1] [F03-OS1.1]
	(2)	[F03-OP3.1] [F03-OS1.1]
	3.9.3.3.	Fire Alarm Systems
	(1)	[F12-OS1.2, OS1.5]
	(2)	
	(3)	
	3.9.3.4.	Provisions for Firefighting
	(1)	[F12-OP1.2] [F12-OS1.2, OS1.5]
	3.9.3.5.	Portable Fire Extinguishers
	(1)	[F02, F12, F81-OP1.2] [F02, F12, F81-OS1.2]
	3.9.3.6.	Means of Egress
	(1)	

Acceptable Solutions	Objectives and Functional Statements
3.9.3.7.	Fuel-Fired Appliances
(1)	[F05-OS1.5] [F43-OS3.7]
(2)	[F03-OP1.2, OP1.4] [F03-OS1.2, OS1.4]
(3)	
(4)	
3.9.3.8.	Washroom Facilities
(1)	
3.9.3.9.	Barrier-Free Access
(1)	
3.10.1.1.	Application
(1)	
3.10.2.1.	Occupancy Classification
(1)	[F02, F03-OS1.2] [F10-OS1.5] Applies to portion of Code text: "b) shall not contain a Group F, Division 1 occupancy."
3.10.2.2.	Occupant Load
(1)	
3.10.2.3.	Structural Fire Protection
(1)	
(2)	[F02, F03, F04-OP1.2] [F02, F04-OP1.3] [F02, F03, F04-OS1.2] [F02, F04-OS1.3]
3.10.2.4.	Safety Requirements Within Floor Areas
(1)	
(2)	
(3)	
(4)	
(5)	[F10-OS1.5] [F30-OS3.1, OS3.7]
(6)	[F10-OS1.5] [F30-OS3.1, OS3.7]
(7)	[F10-OS1.5]
(8)	[F10-OS1.5] [F30-OS3.1, OS3.7]
(9)	[F02, F03-OS1.2]
(10)	[F02, F03-OS1.2]
(11)	
(12)	
3.10.2.5.	Exit Requirements
(1)	
(2)	[F10-OS3.7]
(3)	
3.10.2.6.	Service Facilities
(1)	
(2)	[F03-OP1.2] [F03-OS1.2]
3.10.2.7.	Sanitary Facilities
(1)	
(2)	[F72-OH2.1] [F71-OH2.3]
3.10.3.1.	Application
(1)	
3.10.3.2.	Spatial Separations
(1)	
(2)	[F03-OP3.1] [F03-OS1.1]

Acceptable Solutions	Objectives and Functional Statements
3.10.3.3.	Fire Alarm Systems
(1)	
(2)	[F11-OS1.5]
(3)	
3.10.3.4.	Provisions for Firefighting
(1)	
(2)	[F12-OP1.2]
	[F12-OS1.2]
(3)	[F12-OP1.2]
	[F12-OS1.2]
3.10.3.5.	Standpipe Systems
(1)	
(2)	
3.10.4. 1.	Application
(1)	
3.10.4. 2.	Building Area
(1)	
3.10.4. 3.	Spatial Separations
(1)	
(2)	
(3)	[F03-OP3.1]
	[F03-OS1.1]
(4)	[F03-OP3.1]
	[F03-OS1.1]
3.10.4.4.	Fire Alarm Systems
(1)	
(2)	
3.10.4.5.	Provisions for Firefighting
(1)	
(2)	[F12-OP1.2]
	[F12-OS1.2]
(3)	[F12-OP1.2]
	[F12-OS1.2]
(4)	
(5)	[F02-OP1.2]
	[F02-OP3.1]
	[F02-OS1.2]
(6)	
(7)	
3.11.1.1.	Application
(1)	
(2)	
(3)	
(4)	
3.11.2.1.	Pool Designations
(1)	
(2)	
(3)	
3.11.3.1.	Construction Requirements
(1)	
(2)	
(3)	

Acceptable Solutions	Objectives and Functional Statements
(4)	[F30, F120-OS3.1]
(5)	[F30, F120-OS3.1]
(6)	[F30, F121-OS3.1]
(7)	[F30, F121-OS3.1]
(8)	[F30, F121-OS3.1]
(9)	(a) [F12, F30, F121-OS3.1] [F123-OS3.7] (b), (c) [F122-OH2.3]
(10)	[F30, F121-OS3.1]
(11)	(a) [F123-OS3.7] (b), (c) [F122-OH2.3] (d) [F122-OH2.3] (d) [F30-OS3.1]
(12)	[F30, F123-OS3.1]
(13)	[F40-OH2.3] [F30-OS3.1]
(14)	[F30-OS3.1]
(15)	[F122-OH2.3] [F30-OS3.1]
(16)	[F40, F41, F122-OH2.3]
(17)	[F40, F122-OH2.3]
R4 (18)	[F30, F120-OS3.1] (b) [F74-OA2]
(19)	[F40, F41, F122-OH2.3]
(20)	[F123-OS3.1]
(21)	[F123-OS3.1]
(22)	[F122-OH2.3] [F34-OS3.1]
(23)	[F30, F123-OS3.1]
(24)	[F30, F120, F121-OS3.1]
(25)	[F30, F120-OS3.1]
(26)	[F30, F36, F120-OS3.1]
R4 3.11.3.2.	Barrier-Free Path of Travel for Outdoor Pool Deck
(1)	[F74-OA2]
R4 3.11.3.3.	Access into Public Pools
(1)	[F74-OA2]
(2)	[F74-OA2] [F121-OS3.1]
(3)	[F74-OA2]
(4)	[F74-OA2]
(5)	[F30-OS3.1]
(6)	[F20-OP2.1]
3.11.4.1.	Diving Boards or Platforms
(1)	
(2)	[F30-OS3.1]
(3)	[F30-OS3.1]
(4)	[F30-OS3.1]
(5)	
(6)	[F30, F120-OS3.1]
(7)	[F30, F120-OS3.1]
(8)	[F30, F120-OS3.1]
(9)	[F30, F120-OS3.1]
(10)	[F30-OS3.1]

Acceptable Solutions	Objectives and Functional Statements
(11)	[F30-OS3.1]
(12)	[F30-OS3.1]
(13)	[F30-OS3.1]
(14)	[F30-OS3.1]
(15)	[F30, F120-OS3.1]
(16)	[F30, F34-OS3.1]
(17)	[F30, F120-OS3.1]
R4	3.11.5.1. Ramps into Public Pools
(1)	[F74-OA2]
(2)	[F30, F120-OS3.1] (d) [F40, F41-OH2.3, OH2.4]
(3)	[F74-OA2] [F30, F120, F121-OS3.1] (b) [F41-OH2.3] (d) [F32-OS3.7]
(4)	[F74-OA2] [F30, F120, F121-OS3.1] (c) [F34-OS3.7]
R4	3.11.5.2. Public Pools in Group B, Division 2 or 3 Major Occupancies
(1)	
(2)	[F30, F120-OS3.1]
(3)	[F30, F34-OS3.1]
(4)	[F30, F34-OS3.1]
	3.11.6.1. Construction Requirements
(1)	
(2)	
(3)	[F40, F41-OH2.3, OH2.4]
(4)	[F30, F121-OS3.1]
(5)	[F30-OS3.1]
(6)	[F122-OH2.3] [F123-OS3.1]
(7)	[F30, F124-OS3.1]
(8)	[F30, F123-OS3.1]
(9)	[F30, F121-OS3.1]
	3.11.7.1. Construction Requirements
(1)	
(2)	
(3)	[F30, F121-OS3.1]
(4)	[F30, F121-OS3.1]
(5)	[F30, F123-OS3.1] [F122-OH2.3]
(6)	[F30, F123-OS3.1]
(7)	[F30, F120-OS3.1]
(8)	[F30, F34-OS3.1]
(9)	[F122-OH2.3]
(10)	[F30, F123-OS3.1]
(11)	[F12, F123-OS3.1]
	3.11.8.1. Recirculation Systems
(1)	[F122-OH2.3]
(2)	
(3)	[F46-OH2.2] [F122-OH2.3]
(4)	

Acceptable Solutions	Objectives and Functional Statements
(5)	[F122-OH2.3]
(6)	[F40, F41-OH2.3] [F124-OS3.1]
(7)	[F40, F41-OH2.3]
(8)	[F122-OH2.3]
(9)	[F122-OH2.3] [F43, F122-OS3.4]
(10)	[F43, F81-OS3.4]
(11)	[F43, F81-OS3.4]
(12)	[F40, F41-OH2.3]
(13)	[F40, F41-OH2.3]
(14)	[F30, F121, F124 -OS3.1]
(15)	[F30, F124-OS3.1]
(16)	[F30, F120-OS3.1]
(17)	[F30, F124-OS3.1]
(18)	[F30, F121, F124-OS3.1]
(19)	
(20)	[F30, F124-OS3.1]
3.11.9.1.	Dressing Rooms and Sanitary Facilities
(1)	[F72-OH2.1] [F70-OH2.2] [F71-OH2.3] [F101-OH6]
(2)	
(3)	
(4)	
(5)	[F40, F71, F122-OH2.3]
(6)	[F40, F122-OH2.3]
(7)	[F40, F71, F122-OH2.2]
(8)	[F31-OS3.2]
(9)	[F41, F45-OH2.3] [F30-OS3.1]
(10)	[F40, F41-OH2.3]
(11)	[F40, F41-OH2.3]
(12)	[F101-OH6]
(13)	[F40, F41-OH2.3] [F101-OH6]
(14)	[F40, F41-OH2.3] [F30-OS3.1]
3.11.10.1.	Lighting and Emergency Provisions
(1)	[F30-OS3.1] [F10-OS3.7]
(2)	[F30-OS3.1] [F10-OS3.7]
(3)	[F30, F123-OS3.1] [F10-OS3.7]
(4)	[F30, F123-OS3.1] [F10-OS3.7]
(5)	[F30, F123-OS3.1] [F10-OS3.7]
(6)	
(7)	[F30-OS3.1]
(8)	[F30-OS3.1]
(9)	[F30-OS3.1] [F11-OS3.7]
(10)	[F30-OS3.1] [F11, F12-OS3.7]
(11)	[F30-OS3.1] [F11, F12-OS3.7]
(12)	[F30, F124-OS3.1]
(13)	[F11, F10, F30-OS3.1]
(14)	[F11-OS3.1]

Acceptable Solutions	Objectives and Functional Statements
3.11.11.1.	Service Rooms and Storage Facilities
(1)	
(2)	[F50-OH1.1] [F04-OS1.3] [F03-OS2.1] [F43, F44-OS3.4] [F10-OS3.7]
(3)	[F01-OS1.1] [F43-OS3.4]
(4)	[F50-OH1.1] [F40, F41-OH2.3] [F43-OS3.4]
(5)	[F50-OH1.1] [F32, F34-OS3.3] [F34, F43-OS3.4]
3.12.1.1.	Application
(1)	
(2)	
(3)	
(4)	
(5)	
3.12.2.1.	Construction Requirements
(1)	
(2)	[F30, F121-OS3.1]
(3)	[F30, F121-OS3.1]
(4)	(a), (b) [F12, F30, F121-OS3.1] [F123-OS3.7] (c), (d) [F122-OH2.3]
(5)	
(6)	[F30, F121-OS3.1]
(7)	[F30, F120, F121-OS3.1]
(8)	[F70, F71, F72-OH2.3]
(9)	[F30, F36-OS3.1]
R4	3.12.3.1. Ramps into Public Spas
(1)	[F123-OS3.1]
(2)	
R4	3.12.3.2. Access into Public Spas
(1)	
(2)	[F74-OA2]
(3)	[F30, F120-OS3.1] [F74-OA2]
(4)	[F74-OA2]
(5)	[F74-OA2]
3.12.4.1.	Water Circulation Systems
(1)	
(2)	[F40, F41-OH2.3]
(3)	[F40, F41, F81-OH2.3] [F122-OH2.2]
(4)	[F30, F124-OS3.1]
(5)	[F30, F124-OS3.1]
(6)	[F30, F124-OS3.1]
(7)	[F30, F81, F121, F124-OS3.1]
(8)	[F30, F124-OS3.1]
(9)	

Acceptable Solutions	Objectives and Functional Statements
(10)	[F30, F124 - OS3.1]
(11)	[F30, F81, F124-OS3.1]
(12)	[F30, F81, F124-OS3.1]
(13)	[F30, F124-OS3.1]
(14)	[F40, F41-OH2.3]
	[F43-OS3.4]
(15)	[F40, F41, F81-OH2.3]
	[F81-OS3.1]
(16)	[F30, F124-OS3.1]
(17)	[F30, F121-OS3.1] [F31-OS3.2]
	[F31-OH1.2]
(18)	[F40, F41-OH2.3]
	[F30-OS3.1]
3.12.5.1.	Lighting and Emergency Provisions
(1)	
(2)	[F13, F30-OS3.1]
(3)	[F30, F124-OS3.1]
(4)	[F11, F30-OS3.1]
(5)	[F30, F124-OS3.1]
3.12.6.1.	Service Rooms and Storage Facilities
(1)	
3.13.1.1.	Scope
(1)	
3.13.1.2.	Definitions
(1)	
3.13.2.1.	Requirements for Stations
(1)	
(2)	
(3)	[F02-OP1.2] Applies to portion of Code text: "... shall be of <i>noncombustible construction</i> ,"
	[F02-OS1.2] Applies to portion of Code text: "... shall be of <i>noncombustible construction</i> ,"
	(a), (c) [F03, F04-OP1.2] [F04-OP1.3]
	(a), (c) [F03, F04-OS1.2] [F04-OS1.3]
	(b), (c) [F04-OP1.3]
	(b), (c) [F04-OS1.3]
(4)	
(5)	[F02-OP1.2] Applies to portion of Code text: "... shall be of <i>noncombustible construction</i> ,"
	[F02-OS1.2] Applies to portion of Code text: "... shall be of <i>noncombustible construction</i> ,"
(6)	[F02-OP1.2] Applies to portion of Code text: "... shall be of <i>noncombustible construction</i> ,"
	[F02-OS1.2] Applies to portion of Code text: "... shall be of <i>noncombustible construction</i> ,"
(7)	
(8)	
(9)	
(10)	[F03, F04-OP1.2] [F04-OP1.3] Applies to portion of Code text: " a) ... floor assemblies shall be <i>fire separations</i> with a <i>fire-resistance rating</i> not less than 2 h," and to Clause (d).
	[F03, F04-OS1.2] [F04-OS1.3] Applies to portion of Code text: " a) ... floor assemblies shall be <i>fire separations</i> with a <i>fire-resistance rating</i> not less than 2 h," and to Clause (d).
	(b), (d) [F04-OP1.3]
	(b), (d) [F04-OS1.3]
	(c), (d) [F04-OP1.3]
	(c), (d) [F04-OS1.3]

Acceptable Solutions	Objectives and Functional Statements
(11)	[F03, F04-OP1.2] [F04-OP1.3] Applies to portion of Code text: " a) ... floor assemblies shall be <i>fire separations</i> with a <i>fire-resistance rating</i> not less than 1 h," and to Clause (d). [F03, F04-OS1.2] [F04-OS1.3] Applies to portion of Code text: " a) ... floor assemblies shall be <i>fire separations</i> with a <i>fire-resistance rating</i> not less than 1 h," and to Clause (d). (b), (d) [F04-OP1.3] (b), (d) [F04-OS1.3] (c), (d) [F04-OP1.3] (c), (d) [F04-OS1.3]
(12)	
3.13.3.1.	Application
(1)	
(2)	
(3)	
(4)	
(5)	
(6)	[F10-OS3.7]
3.13.3.2.	Booths and Kiosks
(1)	[F02-OP1.2] Applies to portion of Code text: "... shall be of <i>noncombustible construction</i> ," [F02-OS1.2] Applies to portion of Code text: "... shall be of <i>noncombustible construction</i> ,"
(2)	[F02, F03-OP1.2] [F02, F03-OS1.2]
(3)	
3.13.3.3.	Service Rooms and Ancillary Spaces
(1)	[F03-OP1.2] [F03-OS1.2]
(2)	[F10-OS1.5]
(3)	
(4)	[F10-OS1.5]
3.13.3.4.	Leased Areas
(1)	[F02, F03-OP1.2] [F02, F03-OS1.2]
(2)	
(3)	[F10-OS1.5]
(4)	[F02-OP1.2] [F02-OS1.2]
(5)	[F02-OP1.2] [F02-OS1.2]
(6)	

Acceptable Solutions	Objectives and Functional Statements
(7)	(a), (b) [F10-OS1.5]
	(c) [F10, F36-OS1.5]
3.13.3.5.	Vehicle Terminal
(1)	(a) [F02-OP1.2]
	(a) [F02-OS1.2]
	(b) [F03-OP1.2]
	(b) [F03-OS1.2]
(2)	
3.13.3.6.	Access to Adjacent Building
(1)	[F03-OP1.2]
	[F03-OS1.2]
(2)	[F03-OS1.2] [F10-OS1.5]
(3)	[F10-OS1.5]
(4)	[F03-OP1.2]
	[F03-OS1.2] [F10-OS1.5]
(5)	[F10-OS1.5]
(6)	
3.13.3.7.	Emergency Lighting
(1)	[F30-OS3.1] [F10-OS3.7]
(2)	[F30-OS3.1] [F10-OS3.7]
3.13.4.1.	Occupant Load
(1)	
(2)	
(3)	
(4)	
(5)	
(6)	
3.13.4.2.	General Requirements
(1)	
(2)	[F10-OS3.7]
(3)	
(4)	[F10-OS3.7]
(5)	[F10-OS3.7]
(6)	
(7)	[F03, F06-OS1.2] [F05, F06-OS1.5]
	[F03, F06-OP1.2]
3.13.4.3.	Number and Location of Means of Egress
(1)	[F05, F10-OS1.2]
(2)	
(3)	[F05, F10-OS1.5]
(4)	
(5)	[F10-OS3.7]
3.13.4.4.	Egress Capacity
(1)	
(2)	
(3)	[F30-OS3.1] [F10-OS3.7]
(4)	[F30-OS3.1] [F10-OS3.7]
(5)	[F30-OS3.1] [F10-OS3.7]
(6)	
3.13.4.5.	Width of Means of Egress
(1)	
(2)	

Acceptable Solutions	Objectives and Functional Statements
(3)	
(4)	[F10-OS3.7]
(5)	
(6)	[F30-OS3.1] [F10-OS3.7]
(7)	[F30-OS3.1] [F10-OS3.7]
3.13.4.6.	Egress Facilities
(1)	[F10-OS3.7]
(2)	[F10-OS3.7]
(3)	[F10-OS3.7]
(4)	(a), (c) [F10-OS3.7] (b) [F81-OS3.7]
(5)	[F10, F81-OS3.7]
3.13.5.1.	Fire Alarm System
(1)	
3.13.5.2.	Exceptions
(1)	
(2)	
3.13.5.3.	Fire Detectors
(1)	[F11-OS1.5]
3.13.5.4.	Central Supervising Station
(1)	[F13, F81-OP1.2] [F13, F81-OS1.2, OS1.5]
3.13.5.5.	Annunciators
(1)	[F12-OS1.2, OS1.5]
3.13.5.6.	Annunciator Indication
(1)	[F12-OS1.2, OS1.5]
(2)	[F13, F81-OP1.2] [F13, F81-OS1.2, OS1.5]
(3)	[F10, F11-OS1.5]
(4)	[F10, F11-OS1.5]
3.13.5.7.	Emergency Power
(1)	
3.13.5.8.	Communication Systems
(1)	[F11, F12-OS3.7]
(2)	[F11, F12-OS3.7]
(3)	[F11, F12-OS3.7]
3.13.5.9.	Emergency Reporting Devices
(1)	[F30-OS3.1] [F11, F12-OS3.7]
(2)	
3.13.5.10.	Sprinkler Systems
(1)	
(2)	[F02-OP1.2] [F02-OS1.2]
(3)	[F12-OP1.2] [F12-OS1.2]
3.13.5.11.	Standpipe and Hose Systems
(1)	[F02-OP1.2] [F02-OS1.2]
(2)	[F12-OP1.2] [F12-OS1.2]
(3)	[F12-OP1.2] [F12-OS1.2]

Acceptable Solutions	Objectives and Functional Statements
(4)	[F02, F12-OP1.2] [F02, F12-OS1.2]
(5)	[F02, F12-OP1.2] [F02, F12-OS1.2]
(6)	
(7)	[F02-OP1.2] [F02-OS1.2]
(8)	[F02-OP1.2] [F02-OS1.2]
3.13.6.1.	Application
(1)	
3.13.6.2.	Washrooms Required
(1)	[F72-OH2.1] [F71-OH2.3]
(2)	[F101-OH6] Applies to portion of Code text: "... provided the door to the room can be locked from the inside."
(3)	
(4)	[F72-OH2.1] [F71-OH2.3]
3.13.7.1.	Application
(1)	[F06-OP1.2] [F06-OS1.2] [F05, F06-OS1.5]
3.13.8.1.	Application
(1)	
(2)	
(3)	[F73-OA1]
3.13.8.2.	Exception
(1)	
3.13.8.3.	Elevator Requirements
(1)	[F73-OA1]
(2)	[F73-OA1]
3.13.8.4.	Emergency Operation of Elevators
(1)	[F12-OP1.2] [F12-OS1.2, OS1.5]
(2)	[F12-OP1.2] [F12-OS1.2, OS1.5]
(3)	[F12-OP1.2] [F12-OS1.2, OS1.5]
(4)	[F12-OP1.2] [F12-OS1.2, OS1.5]
3.13.8.5.	Washrooms Required to be Barrier-Free
(1)	[F73-OA1]
(2)	[F74-OA2]
(3)	[F74-OA2]
(4)	[F74-OA2]
(5)	[F74-OA2]
3.14.1.1.	Application
(1)	
3.14.1.2.	General
(1)	
(2)	
3.14.1.3.	Means of Egress
(1)	
(2)	
(3)	[F10, F12-OS3.7]

r4
r4

Acceptable Solutions	Objectives and Functional Statements
3.14.1.4.	Clearance to Other Structures
(1)	[F03-OP3.1]
(2)	[F03-OP3.1]
(3)	
(4)	
(5)	
3.14.1.5.	Clearances to Flammable Material
(1)	[F01-OP1.1] [F03-OP1.2] [F01-OS1.1] [F03-OS1.2]
3.14.1.6.	Flame Resistance
(1)	[F01, F02-OP1.2] [F01, F02-OS1.2]
3.14.1.7.	Bleachers
(1)	
3.14.1.8.	Sanitary Facilities
(1)	
(2)	
(3)	
3.14.1.9.	Provision for Firefighting
(1)	[F12-OP1.2] [F12-OS1.2]
3.14.1.10.	Electrical Systems
(1)	[F34-OP1.1] [F34-OS1.1] [F34-OS3.3]
(2)	[F81-OP1.1] [F81-OS1.1]
3.14.2.1.	Application
(1)	
3.14.2.2.	General
(1)	[F01, F02, F36-OS1.5] Applies to portion of Code text: " <i>Air-supported structures shall not be used for ... Group F, Division 1 major occupancies ...</i> " [F10, F36-OS3.7] Applies to portion of Code text: " <i>Air-supported structures shall not be used for Groups B, C, ... major occupancies or for classrooms.</i> "
(2)	[F02, F03-OS1.2]
(3)	
(4)	
(5)	
3.14.2.3.	Spatial Separation
(1)	[F03-OP3.1]
(2)	
(3)	[F03-OP1.2] [F03-OS1.2]
(4)	[F03-OP1.2] [F03-OS1.2]
3.14.2.4.	Clearances to Flammable Material
(1)	[F01-OP1.1] [F03-OP1.2] [F01-OS1.1] [F03-OS1.2]
3.14.2.5.	Flame Resistance
(1)	F01, [F02-OP1.2] [F01, F02-OS1.2]
(2)	

Acceptable Solutions	Objectives and Functional Statements
3.14.2.6.	Emergency Air Supply
(1)	[F20-OS3.7]
3.14.2.7.	Electrical Systems
(1)	[F34-OP1.1] [F34-OS1.1] [F34-OS3.3]
(2)	[F81-OP1.1] [F81-OS1.1]
3.15.1.1.	Application
(1)	
3.15.1.2.	Exceptions
(1)	
3.15.2.1.	Exceptions for Alterations
(1)	
3.15.3.1.	Structural Design
(1)	
3.15.4.1.	Combustible Sign Faces
(1)	[F02-OP1.2] [F02-OS1.2]
(2)	[F02-OP1.2] [F02-OS1.2]
(3)	
(4)	[F02-OP1.2] [F02-OS1.2]
(5)	[F02-OP1.2] [F02-OS1.2]
3.15.5.1.	Obstructions not Permitted
(1)	[F50-OH1.1] [F102-OH7] [F12-OP1.2] [F12-OS1.2] [F10, F12-OS1.5] [F30-OS3.7]
3.15.5.2.	Clearance for Exterior Signs
(1)	[F30-OS3.1]
(2)	[F30-OS3.1]
(3)	
(4)	[F32-OS3.3]
3.16.1.1.	Application
(1)	
(2)	
(3)	
(4)	
3.16.1.2.	General
(1)	[F02, F03-OS1.2] [F10-OS1.5] [F30-OS3.1] [F36-OS3.6]
(2)	
(3)	[F10-OS1.5]
(4)	[F10-OS1.5]
3.16.1.3.	Construction
(1)	
(2)	[F30-OS3.1]
(3)	

Acceptable Solutions	Objectives and Functional Statements
(4)	[F02, F12, F81-OP1.2] [F02, F12, F81-OS1.2]
3.16.1.4.	Signs
(1)	[F20-OP2.1] [F20-OS2.1]
(2)	[F01-OP1.1] [F01-OS1.1]
3.16.1.5.	Lighting
(1)	[F30-OS3.1]
(2)	[F10-OS3.7]
3.16.1.6.	Sprinkler System
(1)	[F02-OP1.2] [F02-OS1.2]
(2)	[F02, F81, F82-OP1.2] [F02, F81, F82-OS1.2]
(3)	[F02-OP1.2] [F02-OS1.2]
(4)	[F81-OP1.2] [F81-OS1.2]
(5)	[F81, F82-OP1.2] [F81, F82-OS1.2]
(6)	[F13-OP1.2] [F13-OS1.2, OS1.5]
(7)	
(8)	[F02-OP1.2]
3.16.1.7.	Exits and Means of Egress
(1)	[F12-OP1.2] [F12-OS1.2] [F10, F12-OS3.7]
(2)	
(3)	
(4)	[F10-OS3.7]
(5)	[F10-OS3.7]
(6)	[F10-OS3.7]
(7)	[F10-OS3.7]
(8)	[F10-OS3.7]
(9)	[F10-OS3.7]
(10)	[F10-OS3.7]
(11)	[F10-OS3.7]
(12)	[F30-OS3.1] [F10-OS3.7]
(13)	[F30-OS3.1] [F10-OS3.7]
3.16.2.1.	Application
(1)	
3.16.2.2.	Construction
(1)	(a) [F13-OP1.2] (a) [F13-OS1.2] [F11, F13-OS1.5] (b) [F13-OP1.2] (b) [F13-OS1.2, OS1.5] (c) [F02-OP1.1]
3.16.3.1.	Application
(1)	

Acceptable Solutions	Objectives and Functional Statements
3.16.3.2.	Construction
(1)	
(2)	[F05-OS1.5]
(3)	[F10-OS1.5]
3.17.1.1.	Application
(1)	
(2)	
(3)	
3.17.2.1.	Change of Use and Compensating Construction
(1)	<p>3.2.6. Applies to additional requirements for high buildings. [F03, F06, F12, F13, F82-OP1.2] [F03-OP3.1] [F02, F03, F06, F12, F13, F82-OS1.2] [F02, F03, F05, F06, F10, F11, F12, F82-OS1.5] [F30-OS3.1] [F11, F12-OS3.7]</p> <p>3.7. Applies to health requirements for buildings. [F74-OA2] [F50-OH1.1] [F40, F72-OH2.1] [F70-OH2.2] [F71-OH2.3] [F40, F41-OH2.4] [F101-OH6] [F102-OH7] [F01-OP1.1] [F01-OS1.1] [F20, F30-OS3.1] [F32-OS3.3] [F43, F44-OS3.4]</p> <p>3.11. Applies to public pools. [F74-OA2] [F50- OH1.1] [F72-OH2.1] [F46, F70-OH2.2] [F40, F41, F45, F71, F122 - OH2.3] [F40, F41-OH2.4] [F101-OH6] [F01-OS1.1] [F04-OS1.3] [F03-OS2.1] [F12, F30, F34, F36, F120, F121, F123, F124-OS3.1] [F31- OS3.2] [F32, F34 - OS3.3] [F34, F43, F44, F81, F122-OS3.4] [F10, F11, F12, F34, F123-OS3.7]</p> <p>3.12. Applies to public spas. [F74-OA2] [F46-OH2.2] [F40, F41, F70, F71, F72, F81, F122 - OH2.3] [F40, F41-OH2.4] [F11, F12, F13, F30, F34, F36, F81, F120, F121, F123, F124-OS3.1] [F43, F81, F122-OS3.4] [F10, F34, F123-OS3.7]</p>
(2)	
3.17.2.2.	Performance Level and Compensating Construction
(1)	[F140-OC]
(2)	
(3)	
(4)	

Table 4
Objectives and Functional Statements Attributed to the Acceptable Solutions in Part 4 of Division B

Acceptable Solution	Objectives and Functional Statements
4.1.1.1.	Scope
(1)	
4.1.1.2.	Reserved
4.1.1.3.	Design Requirements
(1)	[F20-OS2.1]
(2)	[F22-OH4] [F22-OP2.4]
(3)	[F20-OS2.1] Applies to structural members where temporary overloading during construction may result in impairment of that or any other member.
(4)	[F20-OS2.1, OS2.3] [F20-OP2.1] [F22-OP2.4]
4.1.1.4	Design Basis
(1)	
(2)	[F20-OS2.1] [F22-OS2.4, OS2.5] [F20-OP2.1] [F22-OP2.4, OP2.5] [F22-OH4]
4.1.2.1.	Loads and Effects
(1)	[F20-OS2.1] [F20-OP2.1] [F22-OP2.4] [F22-OH4]
(2)	[F20-OS2.1]
(3)	[F20-OS2.1]
4.1.2.2.	Loads Not Listed
(1)	[F20-OS2.1] [F20-OP2.1] [F22-OP2.4] [F22-OH4]
4.1.3.1.	Definitions
(1)	
4.1.3.2.	Strength and Stability
(1)	[F20-OS2.1] [F20-OP2.1] [F22-OP2.4]
(2)	[F20-OS2.1] [F22-OS2.4, OS2.5] Applies to the stabilizing resistance of the <i>dead load</i> . [F20-OP2.1] [F22-OP2.4, OP2.5]
(3)	[F20-OS2.1] [F22-OS2.4, OS2.5] Applies to the stabilizing resistance of the <i>dead load</i> . [F20-OP2.1] [F22-OP2.4, OP2.5]
(4)	[F20-OS2.1] [F20-OP2.1] [F22-OP2.4]
(5)	[F20-OS2.1] [F22-OS2.4, OS2.5] [F20-OP2.1] [F22-OP2.4, OP2.5]
(6)	
(7)	
(8)	[F20-OS2.1] [F20-OP2.1] [F22-OP2.4]
(9)	[F20-OS2.1] [F20-OP2.1] [F22-OP2.4]
(10)	
(11)	[F20-OS2.1] [F22-OS2.4, OS2.5]

Acceptable Solution	Objectives and Functional Statements
(12)	[F20-OS2.1] [F20-OP2.1] [F22-OP2.4]
4.1.3.3.	Fatigue
(1)	[F20-OS2.1] [F20-OP2.1] [F22-OP2.4]
(2)	[F20-OS2.1] [F20-OP2.1] [F20, F22-OP2.4] [F22-OH4]
4.1.3.4.	Serviceability
(1)	[F22-OP2.4] [F22-OH4]
4.1.3.5.	Deflection
(1)	[F22-OH4] [F22-OP2.4] (b), (c), (d) [F22-OP2.4]
(2)	[F22-OS2.3, OS2.4] [F22-OP2.4]
(3)	[F22-OP2.4]
(4)	
(5)	[F22-OS2.3, OS2.4] [F22-OP2.3, OP2.4]
4.1.3.6.	Vibration
(1)	[F22-OH4] [F22-OP2.4]
(2)	[F20-OS2.1] [F20-OP2.1] [F20, F22-OP2.4] [F22-OH4]
(3)	
4.1.4.1.	Dead Loads
(1)	
(2)	[F20-OS2.1] [F20-OP2.1] [F22-OP2.4]
(3)	[F20-OS2.1] [F20-OP2.1] [F22-OP2.4]
(4)	
(5)	[F20-OS2.1] [F20-OP2.1] [F22-OP2.4]
(6)	[F20-OS2.1] [F22-OS2.4, OS2.5]
4.1.5.1.	Loads Due to Use of Floors and Roofs
(1)	[F20-OS2.1] [F20-OP2.1] [F22-OP2.4] [F22-OH4]
(2)	
4.1.5.2.	Uses Not Stipulated
(1)	[F20-OS2.1] [F20-OP2.1] [F22-OP2.4] [F22-OH4]
(2)	
4.1.5.3.	Full and Partial Loading
(1)	[F20-OS2.1] [F20-OP2.1] [F22-OP2.4] [F22-OH4]

Acceptable Solution	Objectives and Functional Statements
4.1.5.4.	Loads for Occupancy Served
(1)	[F20-OS2.1] [F20-OP2.1] [F22-OP2.4] [F22-OH4]
4.1.5.5.	Loads on Exterior Areas
(1)	[F20-OS2.1] [F20-OP2.1] [F22-OP2.4] [F22-OH4]
(2)	[F20-OS2.1] [F20-OP2.1] [F22-OP2.4] [F22-OH4]
(3)	[F20-OS2.1] [F20-OP2.1] [F22-OP2.4] [F22-OH4]
(4)	[F20-OS2.1] [F20-OP2.1] [F22-OP2.4] [F22-OH4]
4.1.5.6.	Loads for Dining Areas
(1)	
4.1.5.7.	More Than One Occupancy
(1)	[F20-OS2.1] [F20-OP2.1] [F22-OP2.4] [F22-OH4]
4.1.5.8.	Variation with Tributary Area
(1)	[F20-OS2.1] [F20-OP2.1] [F22-OP2.4] [F22-OH4]
(2)	
(3)	[F20-OP2.1, OP2.4]
(4)	
4.1.5.9.	Concentrated Loads
(1)	[F20-OS2.1] [F20-OP2.1] [F22-OP2.4]
4.1.5.10.	Sway Forces in Assembly Occupancies
(1)	[F20-OS2.1] [F20-OP2.1, OP2.4]
4.1.5.11.	Crane-Supporting Structures and Impact of Machinery and Equipment
(1)	[F20-OS2.1] [F20-OP2.1] [F20, F22-OP2.4]
(2)	
(3)	[F20-OS2.1] [F20-OP2.1, OP2.4]
(4)	[F20-OS2.1] [F20-OP2.1, OP2.4]
(5)	[F20-OS2.1] [F20-OP2.1, OP2.4]
4.1.5.12.	Bleachers
(1)	[F20-OS2.1] [F20-OP2.1][F22-OP2.4]
(2)	
(3)	[F20-OS2.4]

Acceptable Solution	Objectives and Functional Statements
4.1.5.13.	Helicopter Landing Areas
(1)	[F20-OS2.1]
	[F20-OP2.1] [F22-OP2.4]
R11.2	4.1.5.14. Loads on Guards and Handrails
(1), (2)	[F20-OS2.1]
(3)	[F20-OS2.1, OS2.4]
(4)	[F22-OS2.4]
(5)	
(6), (7)	[F20-OS2.1]
4.1.5.15.	Loads on Vehicle Guardrails
(1)	[F20-OS2.1]
R11.2	(2)
4.1.5.16.	Loads on Walls Acting as Guards
(1)	[F20-OS2.1]
4.1.5.17.	Firewalls
(1)	[F20-OS1.2]
	[F20-OP1.2]
	[F20-OP3.1]
(2)	[F04-OS1.2]
	[F04-OP1.2]
	[F04-OP3.1]
4.1.6.1.	Specified Load Due to Rain or to Snow and Associated Rain
(1)	
4.1.6.2.	Specified Snow Load
(1)	[F20-OS2.1]
	[F20-OP2.1] [F22-OP2.4]
(2)	[F20-OS2.1]
	[F20-OP2.1] [F22-OP2.4]
(3)	[F20-OS2.1]
	[F20-OP2.1] [F22-OP2.4]
(4)	
(5)	[F20-OS2.1]
	[F20-OP2.1] [F22-OP2.4]
(6)	[F20-OS2.1]
	[F20-OP2.1] [F22-OP2.4]
(7)	[F20-OS2.1]
	[F20-OP2.1] [F22-OP2.4]
R11.1	(8)
	[F20-OS2.1] Applies to portion of Code text: "The accumulation factor, Ca, shall be 1.0, ..."
	[F20-OP2.1] [F22-OP2.4] Applies to portion of Code text: "The accumulation factor, Ca, shall be 1.0,..."
	(a) to (f) [F20-OS2.1] Applies to roof shapes and configurations that call for a higher accumulation factor.
	(a) to (f) [F20-OP2.1] [F22-OP2.4] Applies to roof shapes and configurations that call for a higher accumulation factor.
R11.1	(9)
	[F20-OS2.1]
	[F20-OP2.1] [F22-OP2.4]
4.1.6.3.	Full and Partial Loading
(1)	[F20-OS2.1]
	[F20-OP2.1] [F22-OP2.4]
(2)	[F20-OS2.1]
	[F20-OP2.1] [F22-OP2.4]
4.1.6.4.	Specified Rain Load
(1)	[F20-OS2.1]
	[F20-OP2.1] [F22-OP2.4]

Acceptable Solution	Objectives and Functional Statements
(2)	[F20-OS2.1] [F20-OP2.1] [F22-OP2.4]
(3)	
(4)	[F20-OS2.1] [F20-OP2.1] [F22-OP2.4]
F11.1	4.1.6.5. Multi-Level Roofs
(1)	[F20-OS2.1] [F20-OP2.1] [F22-OP2.4]
(2)	[F20-OS2.1] [F20-OP2.1] [F22-OP2.4]
(3)	[F20-OS2.1] [F20-OP2.1] [F22-OP2.4]
(4)	[F20-OS2.1] [F20-OP2.1] [F22-OP2.4]
F11.1	4.1.6.6. Horizontal Gap Between a Roof and a Higher Roof
(1)	[F20-OS2.1] [F20-OP2.1] [F22-OP2.4]
F11.1	4.1.6.7. Areas Adjacent to Roof Projections
(1)	[F20-OS2.1] [F20-OP2.1] [F22-OP2.4]
(2)	
(3)	
F11.1	4.1.6.8. Snow Drift at Corners
(1)	[F20-OS2.1] [F20-OP2.1] [F22-OP2.4]
(2)	[F20-OS2.1] [F20-OP2.1] [F22-OP2.4]
F11.1	4.1.6.9. Gable Roofs
(1)	[F20-OS2.1] [F20-OP2.1] [F22-OP2.4]
(2)	[F20-OS2.1] [F20-OP2.1] [F22-OP2.4]
(3)	
(4)	[F20-OS2.1] [F20-OP2.1] [F22-OP2.4]
F11.1	4.1.6.10. Arch Roofs, Curved Roofs and Domes
(1)	[F20-OS2.1] [F20-OP2.1] [F22-OP2.4]
(2)	[F20-OS2.1] [F20-OP2.1] [F22-OP2.4]
(3)	[F20-OS2.1] [F20-OP2.1] [F22-OP2.4]
(4)	[F20-OS2.1] [F20-OP2.1] [F22-OP2.4]
(5)	[F20-OS2.1] [F20-OP2.1] [F22-OP2.4]
(6)	[F20-OS2.1] [F20-OP2.1] [F22-OP2.4]

Acceptable Solution	Objectives and Functional Statements
(7)	[F20-OS2.1]
	[F20-OP2.1] [F22-OP2.4]
(8)	
(9)	[F20-OS2.1]
	[F20-OP2.1] [F22-OP2.4]
R11.1 4.1.6.11.	Snow Loads Due to Sliding
(1)	[F20-OS2.1]
	[F20-OP2.1] [F22-OP2.4]
(2)	
(3)	[F20-OS2.1]
	[F20-OP2.1] [F22-OP2.4]
R11.1 4.1.6.12.	Valleys in Curved or Sloped Roofs
(1)	[F20-OS2.1]
	[F20-OP2.1] [F22-OP2.4]
(2)	[F20-OS2.1]
	[F20-OP2.1] [F22-OP2.4]
(3)	[F20-OS2.1]
	[F20-OP2.1] [F22-OP2.4]
R11.1 4.1.6.13.	Specific Weight of Snow
(1)	[F20-OS2.1]
	[F20-OP2.1] [F22-OP2.4]
R11.1 4.1.6.14.	Snow Removal
(1)	[F20-OS2.1]
	[F20-OP2.1] [F22-OP2.4]
R11.1 4.1.6.15.	Ice Loading of Structures
(1)	[F20-OS2.1]
	[F20-OP2.1] [F22-OP2.4]
R11.1 4.1.7.1.	Specified Wind Load
(1)	
(2)	[F20-OS2.1]
	[F20-OP2.1] [F22-OP2.4]
	[F22-OH4]
(3)	[F20-OS2.1]
	[F20-OP2.1][F22-OP2.4]
	[F22-OH4]
(4)	[F20-OS2.1]
	[F20-OP2.1] [F22-OP2.4]
	[F22-OH4]
(5)	[F20-OS2.1]
	[F20-OP2.1] [F22-OP2.4]
(6)	[F20-OS2.1]
	[F20-OP2.1] [F22-OP2.4]
	[F22-OH4]
R11.1 4.1.7.2.	Classification of Buildings
(1)	[F20-OS2.1]
	[F20-OP2.1] [F22-OP2.4]
	[F22-OH4]
(2)	[F20-OS2.1]
	[F20-OP2.1] [F22-OP2.4]
	[F22-OH4]

Acceptable Solution	Objectives and Functional Statements
(3)	[F20-OS2.1] [F20-OP2.1] [F22-OP2.4] [F22-OH4]
R11.1	4.1.7.3. Static Procedure
(1)	[F20-OS2.1] [F20-OP2.1] [F22-OP2.4] [F22-OH4]
(2)	[F20-OS2.1] [F20-OP2.1] [F22-OP2.4] [F22-OH4]
(3)	[F20-OS2.1] [F20-OP2.1] [F22-OP2.4] [F22-OH4]
(4)	[F20-OS2.1] [F20-OP2.1] [F22-OP2.4] [F22-OH4]
(5)	[F20-OS2.1] [F20-OP2.1] [F22-OP2.4] [F22-OH4]
(6)	[F20-OS2.1] [F20-OP2.1] [F22-OP2.4] [F22-OH4]
(7)	[F20-OS2.1] [F20-OP2.1] [F22-OP2.4] [F22-OH4]
(8)	[F20-OS2.1] [F20-OP2.1] [F22-OP2.4] [F22-OH4]
(9)	
(10)	[F20-OS2.1] [F20-OP2.1] [F22-OP2.4] [F22-OH4]
R11.1	4.1.7.4. Topographic Factor
(1)	[F20-OS2.1] [F20-OP2.1] [F22-OP2.4] [F22-OH4]
(2)	[F20-OS2.1] [F20-OP2.1] [F22-OP2.4] [F22-OH4]
R11.1	4.1.7.5. External Pressure Coefficients
(1)	
(2)	[F20-OS2.1] [F20-OP2.1] [F22-OP2.4] [F22-OH4]
(3)	[F20-OS2.1] [F20-OP2.1] [F22-OP2.4] [F22-OH4]
(4)	[F20-OS2.1] [F20-OP2.1] [F22-OP2.4] [F22-OH4]

Acceptable Solution		Objectives and Functional Statements
	(5)	[F20-OS2.1]
F11.1	4.1.7.6. External Pressure Coefficients for Low Buildings	
	(1)	
	(2)	[F20-OS2.1]
		[F20-OP2.1] [F22-OP2.4]
		[F22-OH4]
	(3)	[F20-OS2.1]
		[F20-OP2.1] [F22-OP2.4]
		[F22-OH4]
	(4)	[F20-OS2.1]
		[F20-OP2.1] [F22-OP2.4]
[F22-OH4]		
(5)	[F20-OS2.1]	
	[F20-OP2.1] [F22-OP2.4]	
	[F22-OH4]	
(6)	[F20-OS2.1]	
	[F20-OP2.1] [F22-OP2.4]	
	[F22-OH4]	
(7)	[F20-OS2.1]	
	[F20-OP2.1] [F22-OP2.4]	
	[F22-OH4]	
(8)	[F20-OS2.1]	
	[F20-OP2.1] [F22-OP2.4]	
	[F22-OH4]	
(9)	[F20-OS2.1]	
	[F20-OP2.1] [F22-OP2.4]	
	[F22-OH4]	
F11.1	4.1.7.7. Internal Pressure Coefficient	
	(1)	[F20-OS2.1]
		[F20-OP2.1] [F22-OP2.4]
[F22-OH4]		
F11.1	4.1.7.8. Dynamic Procedure	
	(1)	[F20-OS2.1]
		[F20-OP2.1] [F22-OP2.4]
		[F22-OH4]
	(2)	[F20-OS2.1]
		[F20-OP2.1] [F22-OP2.4]
		[F22-OH4]
	(3)	[F20-OS2.1]
		[F20-OP2.1] [F22-OP2.4]
		[F22-OH4]
(4)	[F20-OS2.1]	
	[F20-OP2.1] [F22-OP2.4]	
	[F22-OH4]	
F11.1	4.1.7.9. Full and Partial Wind Loading	
	(1)	[F20-OS2.1]
		[F20-OP2.1] [F22-OP2.4]
[F22-OH4]		

Acceptable Solution	Objectives and Functional Statements
R11.1	4.1.7.10. Interior Walls and Partitions
(1)	[F20-OS2.1] [F20-OP2.1] [F22-OP2.4]
R11.1	4.1.7.11. Exterior Ornamentations, Equipment and Appendages
(1)	[F20-OS2.1] [F20-OP2.1] [F22-OP2.4]
(2)	
R11.1	4.1.7.12. Wind Tunnel Procedure
(1)	[F20-OS2.1] [F20-OP2.1] [F22-OP2.4] [F22-OH4]
(2)	[F20-OS2.1] [F20-OP2.1] [F22-OP2.4] [F22-OH4]
(3)	[F20-OS2.1] [F20-OP2.1] [F22-OP2.4] [F22-OH4]
R11.1	4.1.8.1. Analysis
(1)	
(2)	(a) [F20-OS2.1] (a) [F20-OP2.1,OP2.3] [F22-OP2.4] (b) [F20-OS2.1] (b) [F20-OP2.1] [F22-OP2.4]
(3)	[F20-OS2.1] [F20-OP2.1, OP2.4]
(4)	[F20-OS2.1] [F20-OP2.1] [F22-OP2.4]
(5)	[F20-OS2.1] [F20-OP2.1] [F22-OP2.4]
(6)	[F20-OS2.1] [F20-OP2.1] [F22-OP2.4]
(7)	[F20-OS2.1] [F20-OP2.1] [F22-OP2.4]
(8)	[F20-OS2.1] [F20-OP2.1] [F22-OP2.4]
(9)	[F20-OS2.1] [F20-OP2.1] [F22-OP2.4]
(10)	[F20-OS2.1] [F20-OP2.1] [F22-OP2.4]
(11)	[F20-OS2.1] [F20-OP2.1] [F22-OP2.4]
(12)	[F20-OS2.1] [F20-OP2.1] [F22-OP2.4]
(13)	[F20-OS2.1] [F20-OP2.3] [F22-OP2.3, OP2.4]
(14)	[F20-OS2.1] [F20-OP2.3] [F22-OP2.3, OP2.4]
(15)	

Acceptable Solution	Objectives and Functional Statements
4.1.8.2.	Notation
(1)	
4.1.8.3.	General Requirements
(1)	
(2)	[F20-OS2.1]
(2)	[F20-OP2.1, OP2.4]
(3)	[F20-OS2.1]
(3)	[F20-OP2.1] [F22-OP2.4]
(4)	[F20-OS2.1]
(4)	[F20-OP2.1] [F22-OP2.4]
(5)	[F20-OS2.1]
(5)	[F20-OP2.1] [F22-OP2.4]
(6)	[F20-OS2.1]
(6)	[F20-OP2.1] [F22-OP2.4]
(7)	[F20-OS2.1]
(7)	[F20-OP2.1] [F22-OP2.4]
(8)	[F20-OS2.1]
(8)	[F20-OP2.1] [F22-OP2.4]
R11.1	4.1.8.4. Site Properties
	(1)
	(1)
	(2)
	(2)
	(3)
	(4)
	(4)
	(5)
	(5)
	(6)
	(6)
	(7)
	(8)
	(9)
	(9)
	4.1.8.5. Importance Factor
	(1)
	(1)
	4.1.8.6. Structural Configuration
	(1)
(1)	
(2)	
(3)	
4.1.8.7. Methods of Analysis	
(1)	
(1)	
4.1.8.8. Direction of Loading	
(1)	
(1)	
4.1.8.9. SFRS Force Reduction Factors, System Overstrength Factors, and General Restrictions	
(1)	
(1)	

Acceptable Solution	Objectives and Functional Statements
(2)	[F20-OS2.1] [F20-OP2.1] [F22-OP2.4]
(3)	[F20-OS2.1] [F20-OP2.1] [F22-OP2.4]
(4)	[F20-OS2.1] [F20-OP2.1] [F22-OP2.4]
(5)	
F11.1	4.1.8.10. Additional System Restrictions
(1)	[F20-OS2.1] [F20-OP2.1] [F22-OP2.4]
(2)	(a) [F20-OP2.3] [F22-OP2.4] (b) [F20-OP2.3] [F22-OP2.4] (c) [F20-OP2.3] [F22-OP2.4] (d) [F20-OP2.3] [F22-OP2.4]
(3)	[F20-OS2.1] [F20-OP2.1] [F22-OP2.4]
(4)	[F20-OS2.1] [F20-OP2.1] [F22-OP2.4]
(5)	
(6)	[F22-OS2.3, OS2.4] [F22-OP2.3, OP2.4]
(7)	[F22-OS2.1] [F20-OP2.1] [F22-OP2.4]
F11.1	4.1.8.11. Equivalent Static Force Procedure for Structures Satisfying the Conditions of Article 4.1.8.7.
(1)	
(2)	[F20-OS2.1] [F20-OP2.1] [F22-OP2.4]
(3)	[F20-OS2.1] [F20-OP2.1] [F22-OP2.4]
(4)	[F20-OS2.1] [F20-OP2.1] [F22-OP2.4]
(5)	[F20-OS2.1] [F20-OP2.1] [F22-OP2.4]
(6)	[F20-OS2.1] [F20-OP2.1] [F22-OP2.4]
(7)	[F20-OS2.1] [F20-OP2.1] [F22-OP2.4]
(8)	[F20-OS2.1] [F20-OP2.1] [F22-OP2.4]
(9)	(a) [F20-OS2.1] (a) [F20-OP2.1] [F22-OP2.4] (b) [F20-OS2.1] (b) [F20-OP2.1] [F22-OP2.4]
(10)	[F20-OS2.1] [F20-OP2.1] [F22-OP2.4]
(11)	(a) [F20-OP2.1] [F22-OP2.4] (a) [F20-OS2.1] (b) [F20-OS2.1] (b) [F20-OP2.1] [F22-OP2.4]
(12)	[F20-OS2.1] [F20-OP2.1] [F22-OP2.4]

Acceptable Solution	Objectives and Functional Statements
R11.1	4.1.8.12. Dynamic Analysis Procedure
(1)	[F20-OS2.1]
	[F20-OP2.1] [F22-OP2.4]
(2)	[F20-OS2.1]
	[F20-OP2.1] [F22-OP2.4]
(3)	[F20-OS2.1]
	[F20-OP2.1] [F22-OP2.4]
(4)	(a) [F20-OP2.1] [F22-OP2.4]
	(a) [F20-OS2.1]
(5)	[F20-OS2.1]
	[F20-OP2.1, OP2.3] [F22-OP2.4]
(6)	
(7)	[F20-OS2.1]
	[F20-OP2.1, OP2.3] [F22-OP2.4]
(8)	[F20-OS2.1]
	[F20-OP2.1] [F22-OP2.4]
(9)	[F20-OS2.1]
	[F20-OP2.1] [F22-OP2.4]
(10)	[F20-OS2.1]
	[F20-OP2.1] [F22-OP2.4]
(11)	
(12)	[F20-OS2.1]
	[F20-OP2.1] [F22-OP2.4]
R11.1	4.1.8.13. Deflections and Drift Limits
(1)	[F22-OS2.3, OS2.4]
	[F22-OP2.3, OP2.4]
(2)	[F22-OS2.3, OS2.4]
	[F22-OP2.3, OP2.4]
(3)	[F22-OS2.3, OS2.4]
	[F22-OP2.3, OP2.4]
(4)	
(5)	
(6)	
R11.1	4.1.8.14. Structural Separation
(1)	[F22-OS2.3, OS2.4]
	[F22-OP2.3, OP2.4]
	[F22-OP4.3]
(2)	[F20-OS2.1, OS2.3, OS2.4]
	[F20-OP2.1, OP2.3, OP2.4]
	[F20-OP4.3]
(3)	[F20-OS2.1, OS2.3, OS2.4]
	[F20-OP2.1, OP2.3, OP2.4]
	[F20-OP4.3]
(4)	[F20-OS2.1, OS2.3, OS2.4]
	[F20-OP2.1, OP2.3, OP2.4]
	[F20-OP4.3]
R11.1	4.1.8.15. Design Provisions
(1)	[F20-OS2.1]
	[F20-OP2.1, OP2.3, OP2.4]
(2)	[F20-OS2.1]
	[F20-OP2.1, OP2.3, OP2.4]

Acceptable Solution	Objectives and Functional Statements
(3)	[F20-OS2.1]
(4)	[F20-OP2.1, OP2.3, OP2.4]
(4)	[F20-OS2.1]
(5)	[F20-OP2.1, OP2.4]
(5)	[F20-OS2.1, OS2.4]
(6)	[F20-OP2.1, OP2.4]
(6)	[F20-OS2.1]
(7)	[F20-OP2.1] [F22-OP2.4]
(7)	[F20-OS2.1]
(8)	[F20-OP2.1] [F22-OP2.4]
(8)	
(9)	
(10)	
F11.1	4.1.8.16. Foundation Provisions
(1)	[F20-OS2.2, OS2.4]
(1)	[F20-OP2.2, OP2.4]
(2)	[F20-OS2.1]
(2)	[F20-OP2.1]
(3)	
(4)	
(5)	[F20-OS2.2, OS2.4]
(5)	[F20-OP2.2, OP2.4]
(6)	(a) [F22-OS2.4]
(6)	(a) [F22-OP2.4]
(6)	(b) [F22-OS2.4]
(6)	(b) [F22-OP2.4]
(6)	(c) [F20-OS2.4]
(6)	(c) [F20-OP2.4]
(7)	[F20-OS2.1]
(7)	[F20-OP2.1, OP2.4]
(8)	(a) [F20-OS2.1]
(8)	(a) [F20-OP2.1]
(8)	(b) [F22-OS2.4]
(8)	(b) [F22-OP2.4]
(9)	[F20-OS2.4]
(9)	[F20-OP2.4]
(10)	[F20-OS2.2] [F22-OS2.4]
(10)	[F20-OP2.2] [F22-OP2.4]
	4.1.8.17. Site Stability
(1)	[F20-OP2.1] [F22-OP2.4]
(1)	[F20-OS2.1]
F11.1	4.1.8.18. Elements of Structures, Non-structural Components and Equipment
(1)	[F20, F22-OS2.4]
(1)	[F20-OP2.3] [F22-OP2.3, OP2.4]
(2)	
(3)	
(4)	[F20, F22-OS2.4]
(4)	[F20, F22-OP2.3, OP2.4]
(5)	[F20, F22-OS2.1]
(5)	[F20, F22-OP2.1, OP2.4]
(6)	[F20, F22-OS2.4]
(6)	[F20, F22-OP2.3, OP2.4]

Acceptable Solution	Objectives and Functional Statements
(7)	[F20, F22-OS2.4] Applies to portion of Code text: "Connections to the structure of elements and components listed in Table 4.1.8.18. shall be designed to support the component or element for gravity loads, shall conform to the requirements of Sentence 4.1.8.18.(1) ..." [F20, F22-OP2.3, OP2.4] Applies to portion of Code text: "Connections to the structure of elements and components listed in Table 4.1.8.18. shall be designed to support the component or element for gravity loads, shall conform to the requirements of Sentence 4.1.8.18.(1)..." (a) [F20, F22-OS2.4] (a) [F20, F22-OP2.3, OP2.4] (b), (c) [F20, F22-OS2.4] (b), (c) [F20, F22-OP2.3, OP2.4] (d) [F20, F22-OS2.4] (d) [F20, F22-OP2.3, O P2.4] (e) [F20, F22-OS2.4] (e) [F20, F22-OP2.3, OP2.4]
(8)	
(9)	[F22-OS2.3, OS2.4] [F22-OP2.3, OP2.4]
(10)	[F22-OS2.1, OS2.3, OS2.4] [F22-OP2.1, OP2.3, OP2.4]
(11)	[F20-OS2.1] [F22-OS2.4] [F20, F22-OP2.3, OP2.4]
(12)	[F20-OS2.1] [F22-OS2.3] [F20-OP2.1] [F22-OP2.3]
(13)	
(14)	[F20, F22-OS2.4]
(15)	
(16)	[F20, F22-OS2.4] [F20-OP2.3] [F22-OP2.3, OP2.4]
R11.1	4.1.8.19. Seismic Isolation
(1)	
(2)	[F20-OS2.1] [F22-OS2.4] [F20-OP2.1] [F22-OP2.4]
(3)	[F20-OS2.1] [F20-OP2.1] [F22-OP2.4]
(4)	[F20-OS2.1] [F20-OP2.1] [F22-OP2.4]
R11.1	4.1.8.20. Seismic Isolation Design Provisions
(1)	[F20-OS2.1] [F20-OP2.1] [F22-OP2.4]
(2)	[F20-OS2.1] [F20-OP2.1] [F22-OP2.4]
(3)	[F20-OS2.1] [F22-OS2.4] [F20-OP2.1] [F22-OP2.4]
(4)	[F20-OS2.1] [F22-OS2.4] [F20-OP2.1] [F22-OP2.4]
(5)	[F20-OS2.1] [F22-OS2.4] [F20-OP2.1] [F22-OP2.4]
(6)	[F20-OS2.1] [F22-OS2.4] [F20-OP2.1] [F22-OP2.4]
(7)	[F20-OS2.1] [F20-OP2.1] [F22-OP2.4]
(8)	

Acceptable Solution	Objectives and Functional Statements
(9)	[F20-OS2.1] [F22-OS2.4] [F20-OP2.1] [F22-OP2.4]
(10)	[F22-OS2.4] [F22-OP2.3, OP2.4]
R11.1	4.1.8.21. Supplemental Energy Dissipation
(1)	
(2)	[F20-OS2.1] [F22-OS2.4] [F20-OP2.1] [F22-OP2.4]
(3)	
(4)	[F20-OS2.1] [F20-OP2.1] [F22-OP2.4]
(5)	[F20-OS2.1] [F20-OP2.1] [F22-OP2.4]
R11.1	4.1.8.22. Supplemental Energy Dissipation Design Consideration
(1)	[F20-OS2.1] [F22-OS2.4] [F20-OP2.1] [F22-OP2.4]
(2)	
(3)	[F20-OS2.1] [F22-OS2.4] [F20-OP2.1] [F22-OP2.4]
(4)	[F20-OS2.1] [F22-OS2.4] [F20-OP2.1] [F22-OP2.4]
(5)	[F20-OS2.1] [F22-OS2.4] [F20-OP2.1] [F22-OP2.4]
(6)	[F20-OS2.1] [F20-OP2.1] [F22-OP2.4]
(7)	[F20-OS2.1] [F22-OS2.4] [F20-OP2.1] [F22-OP2.4]
(8)	[F20-OS2.1] [F22-OS2.4] [F20-OP2.1] [F22-OP2.4]
4.2.1.1.	Application
(1)	
4.2.2.1.	Subsurface Investigation
(1)	[F20-OS2.2] [F20, F21-OS2.6] [F20-OP2.2] [F21-OP2.6] [F21-OP4.1, OP4.4]
4.2.2.2.	Field Review
(1)	[F20-OP2.2] [F21-OP2.5] [F21-OP4.1, OP4.4] [F20-OS2.2] [F20, F21-OS2.6]
(2)	
4.2.2.3.	Altered Subsurface Condition
(1)	[F20-OP2.2] [F21-OP2.6] [F21-OP4.1, OP4.4] [F20-OS2.2] [F20, F21-OS2.6]
(2)	[F20-OP2.2] [F21-OP2.6] [F21-OP4.1, OP4.4] [F20-OS2.2] [F20, F21-OS2.6]
4.2.3.1.	Wood
(1)	

Acceptable Solution	Objectives and Functional Statements
e7 4.2.3.2.	Preservation Treatment of Wood
(1)	[F80-OS2.3]
	[F80-OP2.3]
4.2.3.3.	Plain and Reinforced Masonry
(1)	
4.2.3.4.	Prevention of Deterioration of Masonry
(1)	[F80-OS2.3]
	[F80-OP2.3]
4.2.3.5.	Concrete
(1)	
4.2.3.6.	Protection Against Chemical Attack
(1)	[F80-OS2.3]
	[F80-OP2.3]
4.2.3.7.	Steel
(1)	
4.2.3.8.	Steel Piles
(1)	[F20-OS2.3]
	[F20-OP2.3]
4.2.3.9.	High Strength Steel Tendons
(1)	[F20, F80-OS2.5, OS2.6]
	[F20, F80-OP2.5, OP2.6]
	[F20, F80-OP4.1, OP4.4]
4.2.3.10.	Corrosion of Steel
(1)	[F80-OS2.3]
	[F80-OP2.3]
	[F80-OP4.1]
4.2.4.1.	Design Basis
(1)	[F20-OS2.2] [F20, F21-OS2.6]
	[F20-OP2.2] [F21-OP2.5]
	[F21-OP4.1, OP4.4]
(2)	
(3)	
(4)	
(5)	[F21-OS2.5]
	[F21-OP2.4, OP2.5]
(6)	
4.2.4.2.	Subsurface Investigation
(1)	[F20-OS2.2] [F20, F21-OS2.6]
	[F20-OP2.2] [F21-OP2.6]
	[F21-OP4.1, OP4.4]
4.2.4.3.	Identification
(1)	[F20-OS2.2] [F20, F21-OS2.6]
	[F20-OP2.2] [F21-OP2.6]
	[F21-OP4.1, OP4.4]
4.2.4.4.	Depth of Foundations
(1)	[F21-OP2.4] Applies to portion of Code text: "... the <i>bearing surface</i> of a <i>foundation</i> shall be below the level of potential damage, including damage resulting from <i>frost action</i> ..."
	[F21-OP2.4] Applies to portion of Code text: "... the <i>foundation</i> shall be designed to prevent damage resulting from <i>adfreezing</i> and frost jacking."
(2)	[F21-OP2.4]

Acceptable Solution	Objectives and Functional Statements
4.2.4.5.	Sloping Ground
(1)	[F21-OS2.2] [F21-OP2.2, OP2.4, OP2.6]
4.2.4.6.	Eccentric and Inclined Loads
(1)	[F20-OS2.1, OS2.2] [F20-OP2.1, OP2.2, OP2.4]
4.2.4.7.	Dynamic Loading
(1)	[F20-OS2.2] [F20-OP2.2, OP2.4, OP2.6] [F20-OH4]
4.2.4.8.	Hydrostatic Uplift
(1)	[F22-OP2.1, OP2.4]
4.2.4.9.	Groundwater Level Charge
(1)	[F21-OP4.1]
4.2.4.10.	Permafrost
(1)	[F20-OS2.2] [F21-OS2.5] [F20-OP2.2] [F20, F21-OP2.4] [F21-OP2.6]
4.2.4.11.	Swelling and Shrinking Soils
(1)	[F21-OP2.4, OP2.6]
4.2.4.12.	Expanding and Deteriorating Rock
(1)	[F21-OP2.4, OP2.6]
4.2.4.13.	Construction on Fill
(1)	(a) [F20-OS2.2] [F21-OS2.5] (b) [F20-OP2.2] [F20, F21-OP2.4] [F21-OP2.6] (c) [F01-OS1.1]
4.2.4.14.	Structural Design
(1)	
4.2.5.1.	Design of Excavations
(1)	
4.2.5.2.	Excavation Construction
(1)	[F21-OP4.1]
(2)	[F20-OS2.6] [F20-OP2.3] [F20, F21-OP4.1]
4.2.5.3.	Supported Excavations
(1)	[F20-OS2.6] [F21-OP4.1]
4.2.5.4.	Unsupported Excavations
(1)	[F20-OS2.6] [F21-OP4.1]
4.2.5.5.	Control of Water Around Excavations
(1)	[F60-OS2.6] [F60-OP4.1, OP4.4]
4.2.5.6.	Loss of Ground
(1)	[F21-OP4.1]
4.2.5.7.	Protection and Maintenance at Excavations
(1)	[F80-OS2.6] [F80-OP4.1]

Acceptable Solution	Objectives and Functional Statements
4.2.5.8.	Backfilling
(1)	[F21-OP4.1] (a) [F21-OP2.1, OP2.4] (a) [F21-OS2.1]
(2)	[F21-OP2.4]
4.2.6.1.	Design of Shallow Foundations
(1)	
4.2.6.2.	Support of Shallow Foundations
(1)	[F20-OS2.2] [F20-OP2.2] [F20, F21-OP2.4]
4.2.6.3.	Incorrect Placement of Shallow Foundations
(1)	[F20-OS2.2] [F20-OP2.2] [F20, F21-OP2.4]
4.2.6.4.	Damaged Shallow Foundations
(1)	[F20-OS2.1] [F20-OP2.1] [F20, F22-OP2.4]
4.2.7.1.	General
(1)	
4.2.7.2.	Design for Deep Foundations
(1)	
(2)	
(3)	[F20-OS2.1, OS2.2] [F21-OS2.5] [F20-OP2.1, OP2.2] [F21, F22-OP2.4]
(4)	
(5)	[F20-OS2.1] [F20-OP2.1] [F20, F22-OP2.4]
(6)	[F20-OP2.1, OP2.4]
4.2.7.3.	Tolerance in Alignment and Location
(1)	[F20-OS2.1] [F20-OP2.1] [F20, F22-OP2.4]
4.2.7.4.	Incorrect Alignment and Location
(1)	[F20-OS2.1] [F20-OP2.1] [F20, F22-OP2.4]
4.2.7.5.	Installation of Deep Foundations
(1)	[F81-OS2.1] [F21-OS2.2, OS2.6] (a), (b) [F81-OP2.1] [F21-OP2.2] [F21, F81-OP2.4] (c) [F21-OP4.1]
4.2.7.6.	Damaged Deep Foundation Units
(1)	[F20-OS2.1] [F20-OP2.1] [F22-OP2.4]
4.2.8.1.	General
(1)	
4.2.8.2.	Use of Existing Foundations
(1)	[F20-OS2.1, OS2.2] [F20-OP2.1, OP2.2] [F22-OP2.4]
4.3.1.1.	Design Basis for Wood
(1)	[F20-OS2.1] [F80-OS2.3] [F20-OP2.1] [F80-OP2.3] [F21, F22, F80-OP2.4] [F21, F22, F80-OH4]

Acceptable Solution	Objectives and Functional Statements
4.3.1.2.	Glue-Laminated Members
(1)	[F20-OS2.1] [F20-OP2.1] [F21, F22-OP2.4] [F21, F22-OH4]
4.3.1.3.	Termites
(1)	
4.3.2.1.	Design Basis for Plain and Reinforced Masonry
(1)	[F20-OS2.1] [F80-OS2.3] [F20-OP2.1] [F80-OP2.3] [F21, F22, F80-OP2.4] [F21, F22, F80-OH4]
4.3.3.1.	Design Basis for Plain, Reinforced and Prestressed Concrete
(1)	[F20-OS2.1] [F80, F81-OS2.3] [F20-OP2.1] [F80, F81-OP2.3] [F21, F22, F80, F81-OP2.4] [F21, F22, F80, F81-OH4]
4.3.4.1.	Design Basis for Structural Steel
(1)	[F20-OS2.1] [F80-OS2.3] [F20-OP2.1] [F80-OP2.3] [F20, F22, F80-OP2.4] [F22, F80-OH4]
4.3.4.2.	Design Basis for Cold Formed Steel
(1)	[F20-OS2.1] [F80-OS2.3] [F20-OP2.1] [F80-OP2.3] [F20, F22, F80-OP2.4] [F22, F80-OH4]
4.3.4.3.	Steel Building Systems
(1)	
4.3.5.1.	Design Basis for Aluminum
(1)	[F20-OS2.1] [F80-OS2.3] [F20-OP2.1] [F80-OP2.3] [F20, F22, F80-OP2.4] [F22, F80-OH4]
4.3.6.1.	Design Basis for Glass
(1)	[F20-OS2.1] [F20-OP2.1]
4.4.1.1.	Design Basis for Air-Supported Structures
(1)	[F20-OS2.1] [F80-OS2.3] [F20-OP2.1] [F80-OP2.3] [F22-OP2.4] [F22-OH4]
e7 4.4.2.1.	Design Basis for Storage Garages and Repair Garages
(1)	[F21, F61, F80-OS2.3] [F21, F61, F80-OP2.3, OP2.4] [F21, F61, F80-OH4]
4.4.3.1.	Guards Over Retaining Walls
(1)	[F30-OS3.1]
4.4.4.1.	Anchor Systems on Building Exterior
(1)	[F30-OS3.1]
(2)	[F20-OS2.1] [F30-OS3.1]
(3)	
(4)	[F81-OS2.3]
e7 4.4.5.1.	Manure Storage Tanks
(1)	
(2)	
(3)	[F43-OS3.4] [F110-OE]

Acceptable Solution	Objectives and Functional Statements
(4)	[F80-OP2.3]
	[F80-OS2.3]
(5)	[F20-OP2.1] [F22-OP2.4]
	[F20-OS2.1]
	[F43-OS3.4]
	[F110-OE]

Table 5
Objectives and Functional Statements Attributed to the Acceptable Solutions in Part 5 of Division B

Acceptable Solution	Objectives and Functional Statements
5.1.1.1.	Scope
(1)	
5.1.2.1.	Exposure to Exterior Space or the Ground and Separation of Dissimilar Environments
(1)	
5.1.3.1.	Reserved
5.1.4.1.	Structural and Environmental Loads
(1)	[F61-OH4] (a) [F20, F51, F55-OS1.4] Applies where required life safety systems are incorporated in environmental separators. (a) [F60, F61, F63-OS2.2, OS2.3] (a) [F55, F61, F63-OH1.1, OH1.2, OH1.3] (b) [F20-OS2.1] [F21, F22-OS2.3, OS2.4] Applies to snow fences and sloped glazing. (b) [F20-OS3.1] Applies to snow fences and sloped glazing. (b) [F20, F21, F22-OH1.1, OH1.2, OH1.3] (b) [F20-OH4]
F11.1 (1.1)	
(2)	
(3)	[F20-OS2.1] [F21, F22-OS2.3, OS2.4] [F20, F21, F22-OH1.1, OH1.2, OH1.3]
(4)	(a), (b) [F20-OS2.1] [F21, F22-OS2.3, OS2.4] (a), (b) [F20, F21, F22-OH1.1, OH1.2, OH1.3]
(5)	[F20, F21, F22-OH1.1, OH1.2, OH1.3] (a) [F20-OS2.1, OS2.3] (b), (c) [F21, F22-OS2.3] (b), (c) [F22-OH4]
5.1.4.2.	Resistance to Deterioration
(1)	[F80, F81-OS1.4] Applies where required life safety systems are incorporated in environmental separators. [F80, F81-OS2.3] [F80, F81-OS3.1] Applies to floor assemblies. [F80, F81-OH1.1, OH1.2, OH1.3] [F80, F81-OH4] Applies to floor assemblies.
(2)	
(3)	
5.1.5.1.	Requirements in Other Parts of the Code
(1)	
5.2.1.1.	Exterior Environmental Loads
(1)	
(2)	[F20-OS2.1] [F20, F40-OH1.1] [F20-OH1.2, OH1.3]
(3)	
5.2.1.2.	Interior Environmental Loads
(1)	[F51, F55, F61, F63-OS1.4] Applies where required life safety systems are incorporated in environmental separators. [F55, F61, F63-OS2.3] [F51, F55, F61, F63-OH1.1, OH1.2]
5.2.1.3.	Environmental Load and Transfer Calculations
(1)	[F51, F61, F63-OS2.3] Applies to heat, air and moisture transfer calculations. [F51, F55, F61, F63-OH1.1, OH1.2] [F51, F61-OH1.3] Applies to heat, air and moisture transfer calculations. [F56-OH3.1] Applies to sound transmission calculations.
(2)	

Acceptable Solution	Objectives and Functional Statements
(3)	[F20-OS1.4] Applies where required life safety systems are incorporated in environmental separators. [F20-OS2.1] [F55, F61, F63-OH1.1, OH1.2] [F55, F61-OH1.3]
5.2.2.1.	Determination of Structural Loads and Effects
(1)	[F20-OS2.1] [F21, F22-OS2.3, OS2.4] [F20, F21, F22-OH1.1, OH1.2, OH1.3] [F20, F21, F22-OH4]
(2)	
(3)	[F20-OS2.1] [F21, F22-OS2.3, OS2.4] [F20, F21, F22-OH1.1, OH1.2, OH1.3] [F20, F21, F22-OH4]
R11.1	5.2.2.2. Determination of Wind Load
(1)	
(2)	[F20-OS2.1] [F22-OS2.3, OS2.4] [F20, F22-OH1.1, OH1.2, OH1.3] [F20, F22-OH4]
(3)	[F20-OS2.1] [F22-OS2.3, OS2.4] [F20, F22-OH1.1, OH1.2, OH1.3] [F20, F22-OH4]
(4)	[F20, F55, F61-OS2.1, OS2.3] [F20, F55, F61-OH1.1, OH1.2, OH 1.3]
(5)	
5.2.2.3.	Design Procedures
(1)	[F20-OS2.1] [F22-OS2.3, OS2.4] [F20, F22-OH1.1, OH1.2, OH1.3] [F20, F22-OH4]
5.3.1.1.	Required Resistance to Heat Transfer
(1)	[F51, F63-OS1.4] Applies where required life safety systems are incorporated in environmental separators. [F63-OS2.3] [F63-OH1.1] [F51, F63-OH1.2]
(2)	
5.3.1.2.	Properties to Resist Heat Transfer or Dissipate Heat
(1)	[F51, F63-OH1.1] [F51, F63-OS1.4] Applies where required life safety systems are incorporated in environmental separators. [F51, F63-OS2.3] [F51-OH1.2] [F30-OS3.1]
R11.1	5.3.1.3. Location and Installation of Materials Providing Thermal Resistance
(1)	[F63-OS2.3] [F51, F63-OH1.1]
(2)	[F51, F63-OS1.4] Applies where required life safety systems are incorporated in environmental separators. [F63-OS2.3] [F51, F63-OH1.1, OH1.2]
5.4.1.1.	Required Resistance to Air Leakage
(1)	(a), (b), (c) [F40, F55-OH1.1] (a), (b), (e) [F51, F52, F54, F55-OH1.2] (c) [F55, F61, F63-OH1.3] (c), (d) [F55, F61, F62, F63-OS2.3] (d) [F55, F62-OS3.1] (e) [F55, F62-OS1.4] Applies where required life safety systems are incorporated in environmental separators.
(2)	[F51, F55-OS1.4] Applies where required life safety systems are incorporated in environmental separators. [F61, F63-OS2.3] [F40, F51, F55, F61, F63-OH1.1] [F51, F52, F54, F55, F61, F63-OH1.2] [F51, F55, F61, F63-OH1.3]

Acceptable Solution	Objectives and Functional Statements
(3)	
5.4.1.2.	Air Barrier System Properties
(1)	[F55-OS1.4] Applies where required life safety systems are incorporated in environmental separators.
	[F55-OS2.3]
	[F55-OH1.1, OH1.2, OH1.3]
(2)	
(3)	[F51, F61, F63-OS1.4] Applies where required life safety systems are incorporated in environmental separators.
	[F61, F63-OS2.3]
	[F51, F55, F61, F63-OH1.1, OH1.2] [F55, F61-OH1.3]
(4)	
5.5.1.1.	Required Resistance to Vapour Diffusion
(1)	[F63-OS2.3]
	[F63-OH1.1, OH1.2]
(2)	[F63-OS2.3]
	[F63-OH1.1, OH1.2]
(3)	
5.5.1.2.	Vapour Barrier Properties and Installation
(1)	[F63-OS2.3]
	[F63-OH1.1, OH1.2]
(2)	[F63-OS2.3]
	[F63-OH1.1, OH1.2]
(3)	[F63-OS2.3]
	[F63-OH1.1, OH1.2]
5.6.1.1.	Required Protection from Precipitation
(1)	[F61-OS2.3]
	[F61-OH1.1, OH1.2, OH1.3]
(2)	
F11.1	5.6.1.2.
	Installation of Protective Materials
(1)	
(2)	
(3)	[F61-OS2.3]
	[F61-OH1.1, OH1.2, OH1.3]
(4)	[F61-OS2.3]
	[F61-OH1.1, OH1.2, OH1.3]
5.6.2.1.	Sealing and Drainage
(1)	[F61, F62-OS2.3]
	[F61, F62-OH1.1, OH1.2, OH1.3]
(2)	
5.6.2.2.	Accumulation and Disposal
(1)	[F30-OS3.1]
(2)	[F61-OS2.3]
	[F61-OH1.1, OH1.2, OH1.3]
(3)	[F21-OS2.2] [F60-OS2.3]
	[F61-OH1.1, OH1.2, OH1.3]
	(a)
	(b) [F21-OP2.6]
(4)	[F61-OS2.3]
	[F61-OH1.1, OH1.2, OH1.3]
F11.1	5.7.1.1.
	Application
(1)	

	Acceptable Solution	Objectives and Functional Statements
F11.1	5.7.1.2.	Required Protection
	(1)	[F60-OS2.3] [F60-OH1.1, OH1.2, OH1.3]
	(2)	[F60-OS2.2, OS2.3] [F60-OH1.1, OH1.2, OH1.3]
F11.1	5.7.2.1.	Application
	(1)	
F11.1	5.7.2.2.	Design of Building Elements under Hydrostatic Loads
	(1)	
	(2)	
F11.1	5.7.2.3.	Required Protection
	(1)	
F11.1	5.7.3.1.	Application
	(1)	
F11.1	5.7.3.2.	Required Protection
	(1)	[F61-OH1.1, OH1.2, OH1.3] [F61-OS2.3]
	(2)	
F11.1	5.7.3.3.	Waterproofing
	(1)	[F61-OH1.1, OH1.2, OH1.3] [F61-OS2.3]
F11.1	5.7.3.4.	Where Dampproofing is Permitted
	(1)	[F61-OH1.1, OH1.2, OH1.3] [F61-OS2.3]
	(2)	[F61-OH1.1, OH1.2, OH1.3] [F61-OS2.3]
F11.1	5.8.1.1.	Required Protection
	(1)	[F56-OH3.1]
	(2)	[F56-OH3.1]
F11.1	5.8.1.2.	Determination of Sound Transmission Ratings
	(1)	[F56-OH3.1]
	(2)	[F56-OH3.1]
F11.1	5.8.1.3.	Compliance with Required Ratings
	(1)	
	(2)	
F11.1	5.8.1.4.	Detailed Method for Calculating STC
	(1)	[F56-OH3.1]
	(2)	[F56-OH3.1]
	(3)	[F56-OH3.1]
	(4)	[F56-OH3.1]
	(5)	[F56-OH3.1]
	(6)	[F56-OH3.1]
	(7)	[F56-OH3.1]
	(8)	[F56-OH3.1]
F11.1	5.8.1.5.	Simplified Method for Calculating STC
	(1)	[F56-OH3.1]
	(2)	[F56-OH3.1]
	(3)	[F56-OH3.1]
	(4)	[F56-OH3.1]
	(6)	[F56-OH3.1]

Acceptable Solution	Objectives and Functional Statements
(7)	[F56-OH3.1]
F11.1	5.9. Reserved
5.10.1.1.	Compliance with Applicable Standards
(1)	[F20-OS2.1] [F51, F61, F63, F80-OS2.3] [F51-OS2.5] Objectives and Functional Statements [F61, F63, F80-OS3.1] [F41, F51, F54, F55, F61, F63, F80-OH1.1] [F51, F54, F55, F61, F63, F80-OH1.2] [F55, F61, F80-OH1.3] [[F61, F63, F80-OH4] Applies to floor assemblies. (a) [F61, F63-OS1.4] Applies where required life safety systems are incorporated in environmental separators.
(2)	
5.10.2.1.	General
(1)	
(2)	
(3)	
5.10.2.2.	Applicable Standards
(1)	[F20, F55, F61, F63-OH1.1, OH1.3] [F20, F55, F61, F63, F81-OH1.3] [F20, F55, F61-OS2.3] [F20, F55, F61-OP2.3]
(2)	
(3)	
5.10.2.3.	Structural Loads, Air Leakage and Water Penetration
(1)	
5.10.2.4.	Heat Transfer
(1)	
(2)	[F63-OS2.3] [F63-OH1.1, OH1.2]
(3)	
F3.1	5.10.3.1. Applicable Standards
(1)	(b) [F63-OH1.1, OH1.2] (b) [F61, F62-OS2.3]
F11.1	5.10.4.1. Definition
(1)	
F11.1	5.10.4.2. Structural and Environmental Loads
(1)	
F11.1	5.10.4.3. Heat Transfer
(1)	
(2)	[F63-OH1.1, OH1.2] [F63-OS2.3]
F11.1	5.10.4.4. Air Leakage
(1)	
(2)	[F55, F63-OH1.1, OH1.2, OH1.3] [F55, F63-OS2.3] [F55-OS1.4] Applies where required life safety systems are incorporated in environmental separation.
(3)	
F11.1	5.10.4.5. Water Penetration
(1)	
(2)	[F61-OH1.1, OH1.2, OH1.3] [F61-OS2.3]
(3)	
(4)	

Table 6
Objectives and Functional Statements Attributed to the Acceptable Solutions in Part 6 of Division B

Acceptable Solution	Objectives and Functional Statements
6.1.1.1.	Scope
(1)	
(2)	
6.1.1.2.	Application
(1)	
6.2.1.1	Good Engineering Practice
R11.1 (1)	[F31, F50, F51, F52, F54, F63-OS3.2, OS3.4] (a), (e), (f), (g), (h), (i) [F50, F51, F52, F54, F63-OH1.1, OH1.2, OH1.3] (a), (d), (e), (f), (g) [F31, F51-OP1.1] (b) [F63-OH1.1] [F51-OH1.2] (b) [F63-OS2.3] (c) [F40, F50, F52-OH1.1] [F51, F52-OH1.2] (c) [F40, F50, F53-OS3.4] (d) [F01-OS1.1] (k) [F131-OR2]
6.2.1.2.	Design Indoor Air Temperatures
(1)	[F51-OH1.2]
(2)	[F51-OH1.2]
6.2.1.3.	Structural Movement
(1)	[F23-OS3.1] [F50, F51, F63-OH1.1, OH1.2, OH1.3]
6.2.1.4.	Installation Standards
(1)	[F43-OP1.1] [F43-OS1.1] [F43-OS3.4]
(2)	[F43-OP1.1] [F43-OS1.1] [F43-OS3.4]
(3)	[F41, F50, F63-OH1.1] [F51, F52-OH1.2] [F63-OS2.3] [F44-OS3.4]
(4)	[F41, F50, F63-OH1.1] [F51, F52-OH1.2] [F63-OS2.3] [F44-OS3.4]
(5)	[F43-OP1.1] [F43-OS1.1] [F43-OS3.4]
(6)	[F51, F63-OH1.2, OH1.3] [F31, F51-OP1.1] [F31, F51, F63-OS3.2, OS3.4]
R3 (7)	[F110-OE]
6.2.1.5.	Fireplaces
(1)	
6.2.1.6.	Heat Recovery Ventilators
(1)	
R11.1 (2)	[F131-OH1.1, OR2]
6.2.1.7.	Outside Design Conditions
(1)	

Acceptable Solution	Objectives and Functional Statements
6.2.1.8.	Installation - General
(1)	[F82-OP1.1] [F82-OS1.1] [F82-OS3.4]
(2)	[F31-OS3.1]
(3)	[F81-OS1.1] [F81-OS3.2, OS3.3, OS3.4]
6.2.1.9.	Expansion, Contraction and System Pressure
(1)	[F20-OS3.2]
6.2.1.10.	Asbestos
(1)	[F43-OH1.1]
6.2.1.11.	Access Openings
(1)	[F36-OS3.6]
6.2.1.12.	Combustible Tubing
(1)	
6.2.2.1.	Required Ventilation
(1)	[F31, F50, F51, F52, F54, F63-OP1.1] [F31, F50, F51, F52, F54, F63-OS1.1]
(2)	[F50-OH1.1]
(3)	
(4)	
6.2.2.2.	Natural Ventilation
(1)	[F50-OH1.1]
(2)	[F50-OH1.1]
6.2.2.3.	Ventilation of Storage and Repair Garages
(1)	[F44, F50-OS3.4]
(2)	[F44-OS3.4]
(3)	[F44-OS3.4]
(4)	[F44, F50-OS3.4]
(5)	[F44, F50-OH1.1] [F44, F50-OS3.4]
(6)	
(7)	[F44, F50-OH1.1] [F44, F50-OS3.4]
(8)	[F44, F50-OH1.1] [F44, F50-OS3.4]
(9)	[F44, F50-OH1.1] [F44, F50-OS3.4]
(10)	
6.2.2.4.	Indoor Air Contaminants
(1)	[F44-OH1.1] [F44-OS3.4]
(2)	[F44-OH1.1]
(3)	[F52-OH1.1]
(4)	[F44-OS3.4]
6.2.2.5.	Hazardous Gases, Dusts or Liquids
(1)	[F01-OP1.1] [F01-OS1.1]
(2)	[F01-OP1.1] [F01-OS1.1]

F11.1

Acceptable Solution	Objectives and Functional Statements
6.2.2.6.	Commercial Cooking Equipment
(1)	[F01, F44-OP1.1] [F01, F44-OS1.1]
(2)	[F02, F81-OP1.2] [F02, F81-OS1.2]
6.2.2.7.	Crawl Spaces and Attic or Roof Spaces
(1)	[F41, F61, F63-OH1.1, OH1.3]
6.2.3.1.	Application
(1)	
(2)	
6.2.3.1A.	Drain Pans
(1)	[F41, F44, F50-OH1.1]
6.2.3.2.	Materials in Air Duct Systems
(1)	[F01, F02-OS1.2]
(2)	[F02-OS1.2]
(3)	[F02-OS1.2]
(4)	[F02-OS1.2]
(5)	[F20, F80-OH1.1, OH1.2]
(6)	[F81-OH1.1] [F44, F81-OS3.4]
(7)	[F20, F80-OH1.1, OH1.2]
6.2.3.3.	Connections and Openings in Air Duct Systems
(1)	[F81-OH1.1, OH1.2] [F44, F81-OS3.4]
(2)	[F82-OS1.1]
6.2.3.4.	Duct Coverings, Linings, Adhesives and Insulation
(1)	[F02-OS1.2]
(2)	[F02-OS1.2]
(3)	[F02-OS1.2]
(4)	[F02-OS1.2]
(5)	[F02-OS1.2]
(6)	[F01, F02-OS1.2]
(7)	[F81-OH1.1, OH1.2] [F81-OP1.1] [F81-OS1.1]
6.2.3.5.	Underground Ducts
(1)	(a) [F44, F81-OH1.2, OH1.3] (b), (c) [F44, F81-OH1.1]
(2)	[F81-OH1.1, OH1.2, OH1.3]
6.2.3.6.	Fire Dampers
(1)	
6.2.3.7.	Smoke Detector Control
(1)	
6.2.3.8.	Exhaust Ducts and Outlets
(1)	[F44-OH1.1]
(2)	[F44-OH1.1]
(3)	[F81-OH1.1, OH1.2]
(4)	[F81-OH1.1, OH1.2]
(5)	[F81-OH1.1]
(6)	[F81-OH1.1]
(7)	[F81-OS1.1]
(8)	[F81-OH1.1]
(9)	[F44, F81-OH1.1] [F44, F81-OS1.1]

Acceptable Solution	Objectives and Functional Statements
(10)	[F44, F81-OH1.1]
(11)	[F44, F81-OH1.1] [F81-OH1.2]
(12)	
(13)	
(14)	[F40, F50-OH1.1]
(15)	[F40, F50-OH1.1]
(16)	[F40, F50-OH1.1]
(17)	
(18)	[F40, F44, F50, F52-OH1.1] [F44-OH3.4] [F01-OS1.1] [F01-OP1.1]
(19)	[F40, F44, F50, F52-OH1.1] [F44-OH3.4] [F01-OS1.1] [F01-OP1.1]
6.2.3.9.	Interconnection of Systems
(1)	[F40-OH1.1] [F44-OS1.1]
(2)	[F44, F81-OH1.1] [F44, F81-OP1.1] [F44, F81-OS1.1]
(3)	[F44, F81-OH1.1]
(4)	[F40-OH1.1] [F44-OS1.1] [F10-OS3.7]
(5)	
(6)	
6.2.3.10.	Ducts in Exits
(1)	
(2)	
6.2.3.11.	Make-up Air
(1)	[F50, F81-OH1.1] [F44, F81-OS3.4]
(2)	[F81-OH1.1] [F44, F81-OS3.4]
(3)	[F81-OH1.2]
6.2.3.12.	Supply, Return, Intake and Exhaust Air
(1)	[F81-OH1.2] [F30-OS3.1]
(2)	[F81-OH1.1] [F44, F81-OS3.4]
(3)	[F81-OH1.1]
(4)	[F81, F82-OH1.1] [F82-OS3.4]
(5)	[F02-OP1.2] [F02-OS1.2]
(6)	[F41, F44-OH1.1]
6.2.3.13.	Filters and Odour Removal Equipment
(1)	[F80-OP1.1] [F80-OS1.1]

	Acceptable Solution	Objectives and Functional Statements
	(2)	[F30-OS3.3] [F43, F81-OH1.1]
	(3)	[F82-OH1.1]
	(4)	[F82-OH1.1]
F11.1	6.2.3.14.	Evaporative Cooling Towers, Evaporative Fluid Coolers and Evaporative Condensers
	(1)	[F41, 44-OH1.1]
	(2)	[F41, 44-OH1.1]
	(3)	[F41, 44-OH1.1] [F46, F81-OH2.2]
	(4)	[F82-OH1.1]
	(5)	[F01, F81-OS1.1]
F11.1	6.2.3.14A.	Evaporative Cooling Sections, Evaporative Air Coolers, Misters, Atomizers, Air Washers and Humidifiers
	(1)	[F80, F81-OP1.1] [F80, F81-OS1.1]
	(2)	[F82-OH1.1]
	(3)	[F44-OH1.1]
	(4)	[F01, F81-OS1.1]
	6.2.3.15.	Fans and Associated Air Handling Equipment
	(1)	[F44, F81-OH1.1] [F44, F81-OS3.4]
	(2)	[F81-OH1.1]
	6.2.3.16.	Vibration Isolation Connectors
	(1)	[F01, F02-OS1.2]
	6.2.3.17.	Tape
	(1)	[F02-OS1.2]
	6.2.3.18.	Construction and Installation of Ducts and Plenums
	(1)	[F20-OH4] [F20-OP2.4] [F20-OS2.3]
	(2)	[F03-OP1.1] [F03-OS1.1]
	(3)	[F63-OH1.1] [F51, F52-OH1.2] [F01-OS1.1] [F20, F63-OS2.3] [F20-OS3.1]
e6.1	(4), (5)	[F43, F63-OH1.1] [F51, F52-OH1.2] [F01-OP1.1] [F01-OS1.1] [F63-OS2.3]
	(6)	[F63-OH1.1] [F51, F52-OH1.2] [F01-OP1.1] [F01-OS1.1] [F63-OS2.3]
	(7)	[F63-OH1.1] [F51, F52-OH1.2] [F63-OS2.3] [F20-OS3.1]
	(8)	[F80-OH1.1, OH1.2] [F80-OS2.3]
	(9)	[F44, F81-OH1.1] [F81-OH1.2]
	6.2.3.19.	Clearances of Ducts and Plenums
	(1)	
	6.2.3.20.	Return-Air System
	(1)	[F63-OH1.1] [F51-OH1.2] [F63-OS2.3]

Acceptable Solution	Objectives and Functional Statements
(2)	[F01-OP1.1] [F01-OS1.1]
(3)	[F01-OP1.1] [F01-OS1.1]
(4)	[F01-OP1.1] [F01-OS1.1]
(5)	[F44-OH1.1] [F44-OS3.4]
(6)	[F40, F44-OH1.1] [F40, F44-OS3.4]
6.2.4.1.	Application
(1)	
6.2.4.2.	Duct Design
(1)	
(2)	
(3)	[F20-OH1.1] [F20, F51, F52-OH1.2] [F20-OS2.3]
6.2.4.3.	Construction and Installation of Ducts and Plenums
(1)	[F20-OH4] [F20-OP2.4] [F20-OS2.3]
(2)	[F03-OP1.1] [F03-OS1.1]
(3)	[F63-OH1.1] [F51, F52-OH1.2] [F01-OS1.1] [F20, F63-OS2.3] [F20-OS3.1]
e6.1 (4), (5)	[F43, F63-OH1.1] [F51, F52-OH1.2] [F01-OP1.1] [F01-OS1.1] [F63-OS2.3]
(6)	[F63-OH1.1] [F51, F52-OH1.2] [F01-OP1.1] [F01-OS1.1] [F63-OS2.3]
(7)	[F63-OH1.1] [F51, F52-OH1.2] [F63-OS2.3] [F20-OS3.1]
(8)	[F01-OP1.1] [F01-OS1.1]
(9)	[F80-OH1.1, OH1.2] [F80-OS2.3]
(10)	[F44, F81-OH1.1] [F81-OH1.2]
(11)	[F44, F81-OH1.1] [F81-OH1.2]
(12)	[F131-OR2]
(13)	[F44, F81-OH1.1, OH1.2, OH1.3]
(14)	[F81-OH1.1, OH1.2, OH1.3]
6.2.4.4.	Warm-Air Supply Outlets
(1)	[F40, F63-OH1.1] [F51, F52-OH1.2] [F63-OS2.3]
(2)	[F63-OH1.1] [F51-OH1.2] [F63-OS2.3]

Acceptable Solution	Objectives and Functional Statements
(3)	[F40, F63-OH1.1] [F51-OH1.2]
(4)	[F40, F63-OH1.1] [F51-OH1.2] [F63-OS2.3]
(5)	[F40, F63-OH1.1] [F51-OH1.2] [F63-OS2.3]
(6)	[F40, F63-OH1.1] [F51-OH1.2] [F63-OS2.3]
(7)	
(8)	[F31-OS3.2]
(9)	[F40, F63-OH1.1] [F51-OH1.2] [F63-OS2.3] Applies to warm-air supply outlets located in finished areas.
(10)	[F40-OH1.1] [F40-OS3.4]
6.2.4.5.	Reserved
6.2.4.6.	Adjustable Dampers and Balance Stops
(1)	[F40, F63-OH1.1] [F51, F52-OH1.2] [F63-OS2.3] Applies to branch supply ducts that are not fitted with diffusers with adjustable stops.
6.2.4.7.	Return-Air System
(1)	[F63-OH1.1] [F51-OH1.2] [F63-OS2.3]
(2)	[F01, F02-OP1.1] [F01, F02-OS1.1]
(3)	[F01-OP1.1] [F01-OS1.1]
(4)	[F01-OP1.1] [F01-OS1.1]
(5)	[F01-OP1.1] [F01-OS1.1]
(6)	[F51, F52-OH1.1, OH1.2] [F51, F52-OS2.3]
(7)	[F63-OH1.1] [F51-OH1.2] [F63-OS2.3]
(8)	
(9)	[F44-OH1.1] [F44-OS3.4]
(10)	[F40-OH1.1] [F44-OS1.1]
(11)	[F63-OH1.1] [F51-OH1.2]
(12)	[F01-OP1.1] [F01-OS1.1]
(13)	[F40, F44-OH1.1] [F40, F44-OS3.4]
(14)	
6.2.4.8.	Coverings, Linings and Insulation
(0.1)	[F01-OP1.1] [F01-OS1.1]
(1)	
(1.1)	[F01-OS1.1] (c) [F01, F02, F05-OS1.5] (c) [F01-OP1.1]
(2)	[F81-OH1.1, OH1.2, OH1.3]

R6
F11.1

Acceptable Solution	Objectives and Functional Statements
6.2.4.9.	Tape
(1)	[F02-OS1.2]
6.2.4.10.	Clearances of Ducts and Plenums
(1)	(a), (b) [F01-OP1.1] (a), (b) [F01-OS1.1]
(2)	(a), (b) [F01-OP1.1] (a), (b) [F01-OS1.1]
(3)	(a), (b), (c) [F01-OP1.1] (a), (b), (c) [F01-OS1.1]
(4)	[F01-OP1.1] [F01-OS1.1]
6.2.4.11.	Exhaust Ducts and Outlets
(1)	[F44, F81-OH1.1] [F81-OH1.2]
(2)	[F81-OH1.1, OH1.2]
(3)	[F81-OS1.1]
(4)	[F81-OH1.1]
6.2.4.12.	Make-up Air
(1)	[F50, F81-OH1.1] [F44, F81-OS3.4]
6.2.4.13.	Supply, Return, Intake and Exhaust Air Openings
(1)	[F81-OH1.2] [F30-OS3.1]
(2)	[F81-OH1.1] [F44, F81-OS3.4]
(3)	[F81-OH1.1]
(4)	[F81, F82-OH1.1] [F82-OS3.4]
(5)	[F02-OP1.2] [F02-OS1.2]
6.2.4.14.	Air Filters and Equipment
(1)	[F80-OP1.1] [F80-OS1.1]
(2)	[F43, F81-OH1.1] [F30-OS3.3]
(3)	[F82-OH1.1]
6.2.5.1.	Location of Appliances
(1)	
6.2.5.2.	Appliances Installed Outside the Building
(1)	(a) [F81-OH1.1] (a) [F81-OP1.1] (a) [F81-OS1.1] (b) [F03-OP3.1] (b) [F03-OS1.2] (c) [F02-OP1.2] (c) [F02-OS1.1, OS1.2]
6.2.6.1.	Applicable Standard
(1)	[F81-OS1.1]
6.2.7.1.	Clearances
(1)	[F01-OP1.1] [F01-OS1.1]

Acceptable Solution	Objectives and Functional Statements
6.2.8.1.	Lining or Backing
(1)	[F01-OP1.1] [F01-OS1.1]
(2)	[F01-OS1.1]
6.2.9.1.	Piping Materials and Installation
(1)	[F20-OS3.2, OS3.4]
(2)	[F21-OH1.1]
(3)	[F20-OS2.2]
6.2.9.2.	Insulation and Coverings
(1)	[F20, F30-OS3.2, OS3.4]
(2)	(a), (b) [F01-OP1.1] (a), (b) [F01-OS1.1]
(3)	[F01, F02-OP1.1, OP1.2] [F01, F02-OS1.1, OS1.2]
(4)	[F01, F02-OP1.1] [F01, F02-OS1.1, OS1.2]
(5)	[F02-OS1.2]
(6)	[F31-OS3.2]
(7)	
6.2.9.3.	Clearances
(1)	[F01-OP1.1] [F01-OS1.1]
6.2.9.4.	Surface Temperature
(1)	[F31-OS3.2]
6.2.9.5.	Protection
(1)	[F01-OP1.1] [F01-OS1.1]
(2)	[F01-OP1.1] [F01-OS1.1]
6.2.9.6.	Piping in Shafts
(1)	
6.2.10.1.	Cooling Units
(1)	(a), (b), (c) [F43-OH1.1] [F51-OH1.2] [F43, F81-OS3.4]
6.2.11.1.	Storage Bins
(1)	[F30, F31, F43-OS3.2, OS3.4]
(2)	[F01-OP1.1] [F01-OS1.1]
(3)	[F30-OH2.1]
(4)	[F01-OP1.1] [F01-OS1.1]
6.2.11.2.	Ash Storage Bins
(1)	[F01-OP1.1] [F01-OS1.1]
(2)	[F01-OP1.1] [F01-OS1.1]
6.2.12.1.	Application
(1)	[F44-OS3.4]
6.2.12.2.	Location of Carbon Monoxide Alarms
(1)	[F44-OS3.4]
(2)	[F44-OS3.4]
(3)	

Acceptable Solution	Objectives and Functional Statements
6.2.12.3.	Installation and Conformance to Standards
(1)	[F44-OS3.4] (a) [F81-OS3.4] (d) [F44-OS3.4]
(2)	
6.2.13.1.	Application
(1)	
6.2.13.2.	General Ventilation
(1)	(a), (b), (d), (e) [F01-OS1.1] (c) [F02, F81, F82-OP1.2] (c) [F02, F81, F82-OS1.1] (c) [F02, F81, F82-OS1.2]
(2)	[F11, F81-OS1.1]
6.2.13.3.	Power-Ventilated Enclosure
(1)	
6.2.13.4.	Enclosure Exhaust Ventilation
(1)	(a), (c), (d) [F01-OS1.1] (a) [F01, F02- OS1.2] (b) [F02, F81-OS1.1] (b) [F02, F81-OS1.2] (b) [F02, F81-OP1.2] (e) [F12-OP1.1] (e) [F12-OP1.2] (e) [F12-OS1.1] (e) [F12-OS1.2]
6.2.13.5.	Enclosure Construction
(1)	(a) [F02, F80-OS1.2] Applies to the portion of the code text "be constructed of <i>noncombustible</i> materials". (a) [F02, F80-OS3.4] Applies to the portion of the code text "materials compatible with and chemically resistant to the flammable vapours and particles being exhausted". (a) [F02, F80-OS1.1] Applies to the portion of the code text "materials compatible with and chemically resistant to the flammable vapours and particles being exhausted". (b) [F02, F80-OP1.2] (b) [F02, F80-OS1.1] (b) [F02, F80-OS1.2]
(2)	
(3)	[F02-OS1.2] [F02-OP1.2]
6.3.1.1.	Requirement for Venting
(1)	
6.3.1.2.	Masonry or Concrete Chimneys
(1)	
(2)	[F01-OP1.1] [F01-OS1.1]
6.3.1.3.	Metal Smoke Stacks
(1)	[F01-OP1.1] [F01-OS1.1]
6.3.1.4.	Reserved
(1)	
6.3.1.5.	Access Ladders
(1)	[F20, F80-OS3.1]
(2)	[F30-OS3.1]

Table 7
Objectives and Functional Statements Attributed to the Acceptable Solutions in Part 7 of Division B

Acceptable Solution	Objective and Functional Statement
7.1.1.1.	Scope
(1)	
7.1.2.1.	Application
(1)	
(2)	
7.1.3.1.	Definitions
(1)	
7.1.4.1.	Facilities Required
(1)	
7.1.4.2.	Floor Drains
(1)	[F62-OH1.3] [F62-OH2.1] [F62, F72-OP5]
(2)	
(3)	[F62-OH1.3] [F62-OH2.1] [F41-OH2.4] Applies to floor drains in garbage rooms. [F62, F72-OP5]
7.1.5.1.	Sanitary Drainage Systems
(1)	[F72-OH2.1]
(2)	[F72-OH2.1] [F72-OP5]
7.1.5.2.	Storm Drainage Systems
(1)	[F72-OP5]
7.1.5.3.	Water Distribution Systems
(1)	[F46, F70-OH2.2]
(2)	
(3)	
7.1.5.4.	Separate Services
(1)	[F70-OH2.1] [F81-OH2.2] Applies to water service pipe. [F81-OH2.6] Applies to drainage pipe. [F81-OP5]
(2)	
(3)	
(4)	[F81-OH2.2] Applies to water service pipe. [F81-OH2.6] Applies to drainage pipe. [F81-OP5]
7.1.5.5.	Private Sewers and Private Water Supply
(1)	[F62, F70-OH2.1] [F81-OH2.2] [F81-OP5]
(2)	[F62, F70-OH2.1] [F81-OH2.6] [F81-OP5]
7.1.6.1.	Lighting and Ventilation Requirements
(1)	[F30-OS3.1] Applies to the requirement for lighting. [F40, F41, F50-OH1.1] Applies to the requirement for ventilation.

Acceptable Solution	Objective and Functional Statement
7.1.6.2.	Accessibility
(1)	[F40-OH2.1] [F71-OH2.3] [F41, F81-OH2.4] [F82-OH2.1, OH2.2, OH2.3, OH2.4] Applies to the need for maintenance. [F81-OP5]
7.1.7.1.	Structural Movement
(1)	[F23-OS3.1] [F81-OH1.3, OH2.1, OH2.4, OH2.6]
7.2.1.1.	Exposure of Materials
(1)	[F80-OH2.1, OH2.2, OH2.3, OH2.4] [F80-OP5]
(2)	[F80-OH2.1] [F80-OP5]
7.2.1.2.	Restrictions on Re-Use
(1)	[F41, F81-OH1.1] Applies to vent pipes. [F81-OH1.3] Applies to water pipes. [F81, F113-OH2.1] [F46, F70-OH2.2] [F71, F72-OH2.3] Applies to equipment. [F43-OS3.4] Applies to equipment. [F81, F113-OP5] Applies to drainage pipes. [F81-OP5] Applies to water pipes.
(2)	[F70-OH2.2]
7.2.1.3.	Identification and Certification
(1) to (4)	
7.2.1.4.	Pipe or Piping
(1)	
7.2.1.5.	Withstanding Pressure
(1)	[F20, F81, F113-OE] [F20, F81, F113-OH2.1, OH2.3] [F20, F81, F113-OP5]
7.2.2.1.	Surface Requirements
(1)	[F41-OH2.4]
7.2.2.2.	Conformance to Standards
(1)	
(2)	[F80, F81-OH2.1, OH2.4] [F80, F81-OP5]
(3)	[F80, F81-OH2.1, OH2.4] [F80, F81-OP5]
(4)	[F80, F81-OH2.1, OH2.4] [F80, F81-OP5]
(5)	[F80, F81-OH2.1, OH2.4] [F80, F81-OP5]
(6)	[F80, F81-OH2.1, OH2.4] [F80, F81-OP5]
(7)	[F80, F81-OH2.1, OH2.4] [F80, F81-OP5]
(8)	[F80, F81-OH2.1, OH2.4] [F80, F81-OP5]
7.2.2.3.	Showers
(1)	[F80-OH2.1] [F80-OP5]
(2)	[F80-OH2.1, OH2.4] [F40-OP5]

Acceptable Solution	Objective and Functional Statement
(3)	[F45-OH2.1]
(4)	[F45-OH2.1]
7.2.2.4.	Concealed Overflows
(1)	[F41, F81-OH2.1, OH2.4]
7.2.2.5.	Water Closets in Public Washrooms
(1)	[F40-OH2.4]
7.2.2.6.	Lavatories
(1)	[F41, F81-OH2.1, OH2.4]
7.2.2.7.	Trough Urinals
(1)	[F40-OH2.1, OH2.4]
7.2.3.1.	Traps
(1)	[F40, F81-OH1.1]
(2)	[F44, F81-OH1.1]
(3)	[F81-OH2.1, OH2.3, OH2.4,] [F81-OP5]
(4)	[F81-OH1.1]
(5)	[F81-OH1.1]
(6)	[F81-OH1.1]
(7)	
(8)	[F81-OH1.1] [F81-OP5]
7.2.3.2.	Interceptors
(1)	[F81, F82-OH2.1, OH2.3, OH2.4]
(2)	[F81-OH2.1, OH2.3, OH2.4]
(3)	
7.2.3.3.	Tubular Traps
(1)	[F82-OH2.1, OH2.4] [F82-OP5]
7.2.4.1.	T and Cross Fittings
(1)	[F81-OH2.1, OH2.4] [F81-OP5]
(2)	[F81-OH2.1, OH2.4] [F81-OP5]
7.2.4.2.	Sanitary T Fittings
(1)	[F81-OH2.1, OH2.4] [F81-OP5]
(2)	[F81-OH2.1, OH2.4] [F81-OP5]
7.2.4.3.	90° Elbows
(1)	[F81-OH2.1, OH2.4] [F81-OP5]
(2)	
(3)	
7.2.4.4.	Fittings Restricted in Use
(1)	[F81-OH2.1, OH2.4] [F81-OP5]
7.2.4.5.	Assembled Pipe or Tubing
(1)	[F81-OH2.1, OH2.4] [F81-OP5]
7.2.5.1.	Reserved
7.2.5.2.	Reserved

Acceptable Solution	Objective and Functional Statement
7.2.5.3.	Concrete Pipe and Fittings
(1)	[F20, F80, F81-OH2.1, OH2.6] [F20, F80, F81-OP5]
(2)	[F20, F80, F81-OH2.1, OH2.6] [F20, F80, F81-OP5]
(3)	[F20, F80, F81-OH2.1, OH2.6] [F20, F80, F81-OP5]
(4)	[F20, F80, F81-OH2.1, OH2.6] [F20, F80, F81-OP5]
(5)	[F20, F80, F81-OH2.1, OH2.6] [F20, F80, F81-OP5]
7.2.5.4.	Vitrified Clay Pipe and Fittings
(1)	[F20, F80, F81-OH2.1, OH2.6] [F20, F80, F81-OP5]
(2)	[F20, F80, F81-OH2.1, OH2.6] [F20, F80, F81-OP5]
(3)	[F20, F80, F81-OH2.1, OH2.6] [F20, F80, F81-OP5]
7.2.5.5.	Polyethylene Pipe and Fittings
(1)	[F20, F81-OH2.2] [F20, F81-OP5]
(2)	[F20, F81-OH2.2] [F20, F81-OP5]
(3)	[F20, F81-OH2.2] [F20, F81-OP5]
7.2.5.6.	Polyethylene Pipe Used Underground
(1)	[F20, F81-OH2.1, OH2.6] [F20, F81-OP5]
7.2.5.7.	Crosslinked Polyethylene Pipe and Fittings
(1)	[F20, F81-OH2.2] [F20, F81-OP5]
7.2.5.8.	PVC Pipe and Fittings
(1)	[F20, F81-OH2.2] [F20, F81-OP5]
(2)	[F20, F81-OH2.2] [F20, F81-OP5]
7.2.5.9.	CPVC Pipe, Fittings and Solvent Cements
(1)	[F20, F81-OH2.2] [F20, F81-OP5]
(2)	[F20, F81-OH2.2] [F20, F81-OP5]
7.2.5.10.	Plastic Pipe, Fittings and Solvent Cement Used Underground
(1)	[F20, F80, F81, F113-OH2.1, OH2.6] [F20, F80, F81, F113-OP5]
(2)	[F20, F80, F81, F113-OH2.1, OH2.6] [F20, F80, F81, F113-OP5]
7.2.5.11.	Transition Solvent Cement
(1)	[F20, F80, F81, F113-OH2.1, OH2.6] [F20, F80, F81, F113-OP5]
(2)	[F20, F80, F81, F113-OH2.1, OH2.6] [F20, F80, F81, F113-OP5]

Acceptable Solution	Objective and Functional Statement
7.2.5.12.	Plastic Pipe, Fittings and Solvent Cement Used in Buildings
(1)	[F20, F43, F81-OH1.1] Applies to venting system. [F20, F80, F81, F113-OH2.1] [F20, F80, F81, F113-OP5]
(2)	[F20, F80, F81-OH1.3] [F20, F80, F81-OP5]
(3)	[F20-OH1.3] [F20-OP5]
(4)	
(5)	
7.2.5.13.	Polyethylene/Aluminum/Polyethylene Composite Pipe and Fittings
(1)	[F20-OH2.1, OH2.2, OH2.3] [F20-OP5]
(2)	[F20-OH2.1, OH2.2, OH2.3] [F20-OP5]
(3)	[F20-OH2.1, OH2.2, OH2.3] [F20-OP5]
(4)	[F20-OH2.1, OH2.2, OH2.3] [F20-OP5]
7.2.5.14.	Crosslinked Polyethylene/Aluminum/Polyethylene Composite Pipe and Fittings
(1)	[F20, F81-OH2.2] [F20, F81-OP5]
7.2.5.15.	Polypropylene Pipe and Fittings
(1)	[F20, F81-OH2.2] [F20, F81-OP5]
7.2.6.1.	Cast Iron Drainage and Vent Pipe and Fittings
(1)	[F20, F43, F81-OH1.1] Applies to venting system. [F20, F80, F81, F113-OH2.1] [F20, F80, F81, F113-OP5]
(2)	[F20, F81-OH2.2] [F20, F81-OP5]
7.2.6.2.	Reserved
7.2.6.3.	Threaded Cast Iron Drainage Fittings
(1)	[F20, F80, F81, F113-OH2.1, OH2.6] [F20, F80, F81, F113-OP5]
(2)	[F20, F81-OH2.2] [F20, F81-OP5]
7.2.6.4.	Cast Iron Water Pipe
(1)	[F20, F81-OH2.2] [F20, F81-OP5]
(2)	[F20, F81-OH2.2] [F20, F81-OP5]
(3)	[F20, F81-OH2.2] [F20, F81-OP5]
(4)	[F20, F81-OH2.2] [F20, F81-OP5]
7.2.6.5.	Screwed Cast Iron Water Fittings
(1)	[F20, F81-OH2.2] [F20, F81-OP5]
(2)	[F20, F81-OH2.2] [F20, F81-OP5]
(3)	[F81-OH2.1]

Acceptable Solution	Objective and Functional Statement
7.2.6.6.	Screwed Malleable Iron Water Fittings
(1)	[F20, F81-OH2.2] [F20, F81-OP5]
(2)	[F20, F81-OH2.2] [F20, F81-OP5]
(3)	[F81-OH2.1]
7.2.6.7.	Steel Pipe
(1)	[F43, F81-OH1.1] Applies to venting system. [F80, F81, F113-OH2.1] Applies to drainage system. [F46, F80, F81-OH2.2] Applies to water piping. [F80, F81, F113-OP5] Applies to drainage system. [F46, F80, F81-OP5] Applies to water piping.
(2)	
(3)	[F46, F80, F81-OH2.2] [F46, F80, F81-OP5]
(4)	[F43, F81-OH1.1] Applies to venting system. [F80, F81, F113-OH2.1] Applies to drainage system. [F80, F81, F113-OP5] Applies to drainage system.
(5)	[F80, F81, F113-OH2.1] [F80, F81, F113-OP5]
(6)	[F43, F81-OH1.1] Applies to venting system. [F80, F81, F113-OH2.1] Applies to drainage system. [F80, F81, F113-OP5] Applies to drainage system.
7.2.6.8.	Corrugated Steel Pipe and Couplings
(1)	[F20, F80, F81-OH1.3] [F20, F80, F81-OP5]
(2)	[F80, F81-OH1.3] [F80, F81-OP5]
(3)	[F80, F81-OH1.3] [F80, F81-OP5] (b) [F20-OH1.3] (b) [F20-OP5]
7.2.6.9.	Sheet Metal Leaders
(1)	[F80, F81-OH1.3] [F80, F81-OP5]
R11.1 7.2.6.10.	Stainless Steel Pipe
(1)	[F80-OH2.1] Applies to drainage systems and venting systems. [F46, F80-OH2.2] Applies to water systems. [F80-OP5]
(2)	[F20-OP5] [F80-OH2.1] Applies to drainage systems and venting systems. [F46, F80-OH2.2] Applies to water systems.
R11.1 7.2.6.11.	Stainless Steel Butt Weld Pipe Fittings
(1)	[F80-OH2.1] Applies to drainage systems and venting systems. [F46, F80-OH2.2] Applies to water systems. [F80-OP5]
(2)	[F80-OH2.1] Applies to drainage systems and venting systems. [F46, F80-OH2.2] Applies to water systems. [F80-OP5]
R11.1 7.2.6.12.	Stainless Steel Pipe Flanges
(1)	[F80-OH2.1] Applies to drainage systems and venting systems. [F46, F80-OH2.2] Applies to water systems. [F80-OP5]

	Acceptable Solution	Objective and Functional Statement
	(2)	[F80-OH2.1] Applies to drainage systems and venting systems. [F46, F80-OH2.2] Applies to water systems. [F80-OP5]
F11.1	7.2.6.13.	Stainless Steel Threaded Fittings
	(1)	[F20-OP5] [F80-OH2.1] Applies to drainage systems and venting systems. [F46, F80-OH2.2] Applies to water systems.
	(2)	[F20-OP5] [F80-OH2.1] Applies to drainage systems and venting systems. [F46, F80-OH2.2] Applies to water systems.
F11.1	7.2.6.14.	Stainless Steel Tube
	(1)	[F46-OH2.2] [F80-OP5]
	(2)	[F46-OH2.2] [F80-OP5]
F11.1	7.2.6.15.	Stainless Steel Pipe and Tube
	(1)	[F80-OH2.1, OH2.2, OH2.3]
	7.2.7.1.	Copper and Brass Pipe
	(1)	[F43, F81-OH1.1] Applies to venting system. [F80, F81, F113-OH2.1] Applies to drainage system. [F46, F80, F81-OH2.2] Applies to water piping. [F80, F81, F113-OP5] Applies to drainage system. [F46, F80, F81-OP5] Applies to water piping.
	(2)	[F43, F81-OH1.1] Applies to venting system. [F80, F81, F113-OH2.1] Applies to drainage system. [F46, F80, F81-OH2.2] Applies to water piping. [F80, F81, F113-OP5] Applies to drainage system. [F46, F80, F81-OP5] Applies to water piping.
	7.2.7.2.	Brass or Bronze Pipe Flanges and Flanged Fittings
	(1)	[F43, F81-OH1.1] Applies to venting system. [F80, F81, F113-OH2.1] Applies to drainage system. [F46, F80, F81-OH2.2] Applies to water piping. [F80, F81, F113-OP5] Applies to drainage system. [F46, F80, F81-OP5] Applies to water piping.
	7.2.7.3.	Brass or Bronze Threaded Water Fittings
	(1)	[F46, F80, F81-OH2.2] [F46, F80, F81-OP5]
	(2)	[F80-OH2.1]
	7.2.7.4.	Copper Tube
	(1)	[F20, F43, F81-OH1.1] Applies to venting system. [F20, F80, F81, F113-OH2.1] Applies to drainage system. [F20, F46, F80, F81-OH2.2] Applies to water piping. [F20, F80, F81, F113-OP5] Applies to drainage system. [F20, F46, F80, F81-OP5] Applies to water piping.
	(2)	[F20, F43, F81-OH1.1] Applies to venting system. [F20, F80, F81, F113-OH2.1] Applies to drainage system. [F20, F46, F80, F81-OH2.2] Applies to water piping. [F20, F80, F81, F113-OP5] Applies to drainage system. [F20, F46, F80, F81-OP5] Applies to water piping.
	(3)	[F20, F46, F80, F81, F113-OH2.1, OH2.2] [F20, F46, F80, F81, F113-OP5]
	(4)	[F20, F46, F80, F81, F113-OH2.1, OH2.2] [F20, F46, F80, F81, F113-OP5]
F11.1	(5)	[F80-OH2.1, OH2.4]

Acceptable Solution	Objective and Functional Statement
7.2.7.5.	Solder-Joint Drainage Fittings
(1)	[F20, F80, F81, F113-OH2.1] [F20, F80, F81, F113-OP5]
(2)	[F20, F80, F81-OH2.2] [F20, F80, F81-OP5]
7.2.7.6.	Solder-Joint Water Fittings
(1)	[F20, F46, F80, F81-OH2.2] [F20, F46, F80, F81-OP5]
(2)	[F20, F46, F80, F81-OH2.2] [F20, F46, F80, F81-OP5]
7.2.7.7.	Flared-Joint Fittings for Copper Tube Water Systems
(1)	[F20, F46, F80, F81-OH2.2] [F20, F46, F80, F81-OP5]
(2)	[F20, F46, F80, F81-OH2.2] [F20, F46, F80, F81-OP5]
7.2.7.8.	Lead Waste Pipe and Fittings
(1)	[F20, F80, F81, F113-OH2.1] Applies to building sewer. [F20, F46, F80, F81-OH2.2] Applies to water piping. [F20, F80, F81, F113-OP5] Applies to drainage system. [F20, F46, F80, F81-OP5] Applies to water piping.
(2)	[F81, F113-OH2.1] [F81, F113-OP5]
7.2.8.1.	Pipe and Fittings
(1)	[F20, F43, F81-OH1.1] Applies to venting system. [F20, F80, F81, F113-OH2.1] Applies to drainage system. [F20, F80, F81, F113-OP5] Applies to drainage system.
7.2.9.1.	Cement Mortar
(1)	[F20, F43, F81-OH1.1] Applies to venting system. [F20, F80, F81, F113-OH2.1] Applies to drainage system. [F20, F46, F80, F81-OH2.2] Applies to water piping. [F20, F80, F81, F113-OP5] Applies to drainage system. [F20, F46, F80, F81-OP5] Applies to water piping.
7.2.9.2.	Solder and Fluxes
(1)	[F20, F43, F81-OH1.1] Applies to venting system. [F20, F80, F81, F113-OH2.1] Applies to drainage system. [F20, F46, F80, F81-OH2.2] Applies to water piping. [F20, F80, F81, F113-OP5] Applies to drainage system. [F20, F46, F80, F81-OP5] Applies to water piping.
(2)	[F46-OH2.2]
(3)	[F80-OH2.1, OH2.2]
(4)	[F80-OH2.1, OH2.3]
7.2.10.1.	Floor Flanges
(1)	[F20, F80, F81, F113-OH2.1] [F20, F80, F81, F113-OP5]
(2)	[F20, F80, F81, F113-OH2.1] [F20, F80, F81, F113-OP5]
(3)	[F20, F80, F81, F113-OH2.1] [F20, F80, F81, F113-OP5]
(4)	[F20, F80, F81, F113-OH2.1] [F20, F80, F81, F113-OP5]
7.2.10.2.	Screws, Bolts, Nuts and Washers
(1)	[F80-OH2.1] [F80-OP5]

Acceptable Solution	Objective and Functional Statement
7.2.10.3.	Cleanout Fittings
(1)	[F80-OH2.1, OH2.3] Applies to drainage systems. [F46-OH2.2] Applies to water systems.
(2)	[F43, F81-OH1.1] Applies to venting system. [F81-OH2.1] Applies to drainage system. [F81-OP5] Applies to drainage system.
(3)	[F80-OH2.1]
7.2.10.4.	Mechanical Couplings
(1)	[F20, F43, F81-OH1.1] Applies to venting system. [F20, F80, F81, F113-OH2.1] Applies to drainage system. [F20, F46, F80, F81-OH2.2] Applies to water piping. [F20, F80, F81, F113-OP5] Applies to drainage system. [F20, F46, F80, F81-OP5] Applies to water piping.
(2)	[F20, F43, F81-OH1.1] Applies to venting system. [F20, F80, F81, F113-OH2.1] Applies to drainage system. [F20, F80, F81, F113-OP5] Applies to drainage system.
7.2.10.5.	Saddle Hubs
(1)	[F81-OH2.1] [F81-OP5]
(2)	
7.2.10.6.	Supply and Waste Fittings
(1)	[F80-OP5]
(2)	[F80-OH2.1, OH2.3]
7.2.10.7.	Linings and Coatings of Domestic Water Tanks
(1)	[F20, F46, F80, F81-OH2.1, OP5]
7.2.10.8.	Direct Flush Valves
(1)	(a), (b), (c) [F130-OR1] (a), (b) [F80, F81-OP5] (c), (d) [F80-OH2.1] [F81-OH2.4] (d) [F46-OH2.2]
7.2.10.9.	Drinking Fountain Bubblers
(1)	[F40, F46-OH2.4]
(2)	[F41, F46-OH2.2] [F130-OR1]
7.2.10.10.	Back-Siphonage Preventers and Backflow Preventers
(1)	[F20, F46, F80, F81-OH2.2] [F20, F46, F80, F81-OP5]
(2)	[F20, F46, F80, F81-OH2.2] [F20, F46, F80, F81-OP5]
7.2.10.11.	Relief Valves
(1)	[F20, F46, F80, F81-OH2.2] [F20, F31, F46, F80, F81-OP5] [F31-OS3.2]
7.2.10.12.	Reducing Valves
(1)	[F20, F46, F80, F81-OH2.2] [F20, F46, F80, F81-OP5]
7.2.10.13.	Solar Domestic Hot Water
(1)	[F46-OH2.2] [F80, F81-OP5] [F81-OS3.2]
7.2.10.14.	Vent Pipe Flashing
(1)	[F61, F80-OH1.3] [F61, F80-OP2.3]

Acceptable Solution	Objective and Functional Statement
(2)	[F61, F80-OH1.3] [F61, F80-OP2.3]
7.2.10.15.	Water Hammer Arresters
(1)	[F20, F46, F80, F81-OH2.2] [F20, F46, F80, F81-OP5]
7.2.10.16.	Air Admittance Valves
(1)	[F20, F43, F81-OH1.1]
7.2.10.17.	Drinking Water Treatment Systems
(1)	[F46-OH2.2] [F40-OS3.4] [F70-OP5]
7.2.11.1.	Design, Construction, Installation and Testing
(1)	[F20, F46, F80, F81-OH2.2] [F12-OP1.4] [F20, F46, F80, F81-OP5] [F12-OS1.4]
7.2.11.2.	Certification or Conformance
(1)	[F20, F46, F80, F81-OH2.2] [F20, F46, F80, F81-OP5]
7.2.11.3.	Tracer Wire
(1)	[F82-OH2.2] [F82-OP5]
(2)	
7.2.11.4.	Required Check Valve
(1)	[F46-OH2.2]
(2)	[F46-OH2.2]
7.3.1.1.	Application
(1)	
7.3.2.1.	Caulked Lead Drainage Joints
(1)	[F80, F81-OH2.1] Applies to drainage system. [F80, F81-OP5] Applies to drainage system.
(2)	[F80-OH2.1]
(3)	[F43, F81-OH1.1] Applies to venting system. [F80, F81-OH2.1] Applies to drainage system. [F80, F81-OP5] Applies to drainage system.
(4)	[F81-OH2.1]
7.3.2.2.	Wiped Joints
(1)	[F43, F80, F81-OH1.1] Applies to venting system. [F80, F81-OH2.1] Applies to drainage system. [F80, F81-OP5] Applies to drainage system.
(2)	[F43, F80, F81-OH1.1] Applies to venting system. [F80, F81-OH2.1] Applies to drainage system. [F80, F81-OP5] Applies to drainage system.
(3)	[F43, F80, F81-OH1.1] Applies to venting system. [F80, F81-OH2.1] Applies to drainage system. [F80, F81-OP5] Applies to drainage system.
7.3.2.3.	Screwed Joints
(1)	[F81-OH2.1] Applies to drainage system. [F46, F81-OH2.2] Applies to water piping. [F81-OP5] Applies to drainage system.
(2)	[F46, F81-OH2.2] Applies to water piping.

Acceptable Solution	Objective and Functional Statement
7.3.2.4.	Solder Joints
(1)	[F43, F80, F81-OH1.1] Applies to venting system. [F80, F81-OH2.1] Applies to drainage system. [F20, F46, F81-OH2.2] Applies to water piping. [F20, F46, F81-OP5] Applies to water piping. [F20, F80, F81-OP5] Applies to drainage system.
7.3.2.5.	Flared Joints
(1)	[F43, F81-OH1.1] Applies to venting system. [F81-OH2.1] Applies to drainage system. [F20, F46, F81-OH2.2] Applies to water piping. [F20, F46, F81-OP5] Applies to water piping. [F20, F81-OP5] Applies to drainage system.
(2)	[F43, F81-OH1.1] Applies to venting system. [F81-OH2.1] Applies to drainage system. [F20, F46, F81-OH2.2] Applies to water piping. [F20, F46, F81-OP5] Applies to water piping. [F20, F81-OP5] Applies to drainage system.
7.3.2.6.	Mechanical Joints
(1)	[F43, F81-OH1.1] Applies to venting system. [F81-OH2.1] Applies to drainage system. [F20, F46, F81-OH2.2] Applies to water piping. [F20, F46, F81-OP5] Applies to water piping. [F20, F81-OP5] Applies to drainage system.
7.3.2.7.	Cold-Caulked Joints
(1)	[F20, F43, F81-OH1.1] Applies to bell and spigot joints in venting systems. [F20, F81-OH2.1] Applies to bell and spigot joints in drainage systems. [F20, F46, F81-OH2.2] Applies to water piping. [F20, F46, F81-OP5] Applies to water piping. [F20, F81-OP5] Applies to bell and spigot joints in drainage systems.
(2)	[F20, F43, F81-OH1.1] Applies to bell and spigot joints in venting systems. [F20, F81-OH2.1] Applies to bell and spigot joints in drainage systems. [F20, F46, F81-OH2.2] Applies to water piping. [F20, F46, F81-OP5] Applies to water piping. [F20, F81-OP5] Applies to bell and spigot joints in drainage systems.
(3)	[F20, F81-OH2.1] Applies to bell and spigot joints in drainage systems. [F20, F81-OP5] Applies to bell and spigot joints in drainage systems.
7.3.2.8.	Stainless Steel Welded Joints
(1)	[F20, F81-OH2.1, OH2.2, OH2.3]
(2)	[F20, F81-OH2.1, OH2.2, OH2.3]
7.3.3.1.	Drilled and Tapped Joints
(1)	[F81-OH2.1] Applies to drainage piping. [F20, F46, F81-OH2.2] Applies to water piping. [F20, F46, F81-OP5] Applies to water piping. [F20, F81-OP5] Applies to drainage piping.
(2)	
(3)	
(4)	
(5)	[F81-OH2.1] [F81-OP5]
7.3.3.2.	Reserved
7.3.3.3.	Prohibition of Welding of Pipes and Fittings
(1)	[F20-OH1.1] [F20-OH2.1, OH2.2]
(2)	[F80-OH2.2] [F80-OP5]

F11.1

Acceptable Solution	Objective and Functional Statement
7.3.3.4.	Unions and Slip Joints
(1)	[F81-OH1.1] [F81-OH2.1]
(2)	[F81-OH1.1] [F81-OH2.1]
7.3.3.5.	Increaser or Reducer
	[F81-OH1.1] [F70, F80-OH2.2]
(1)	
7.3.3.6.	Connection of Dissimilar Materials
(1)	[F80-OH1.1] [F80-OH2.1] [F80-OP5]
7.3.3.7.	Connection of Roof Drain to Leader
(1)	[F21, F61, F81-OP5]
7.3.3.8.	Connection of Floor Outlet Fixtures
(1)	[F80-OH2.1] [F80-OP5]
(2)	[F80-OH2.1] [F80-OP5]
(3)	
(4)	[F20-OH2.1] [F20-OP5] [F20-OS3.1]
(4.1)	[F81-OH2.1]
(5)	[F21-OH2.1] [F21-OP5]
7.3.3.9.	Expansion and Contraction
(1)	[F21-OH1.1] [F21-OH2.1] [F21-OH2.2] [F21-OP5]
7.3.3.10.	Copper Tube
(1)	[F20-OH1.1] [F20-OH2.1] [F20-OH2.2] [F20-OP5]
(2)	[F20-OH1.1] [F20-OH2.1] [F20-OH2.2] [F20-OP5]
7.3.3.11.	Indirect Connections
(1)	[F81-OH2.2, OH2.4]
(2)	[F81-OH2.2, OH2.4]
7.3.3.12.	Copper Joints Used Underground
(1)	[F20, F80, F81, F113-OP5] Applies to drainage pipe. [F20, F46, F80, F81-OP5] Applies to water pipe.
(2)	[F80-OP5]
7.3.4.1.	Capability of Support
(1)	[F20-OH1.1] [F20-OH2.1, OH2.2] [F20-OP5] [F20-OS3.1]
(2)	[F20-OH2.1] [F20-OP5] [F20-OS3.1]

F11.1

Acceptable Solution	Objective and Functional Statement
(3)	[F20-OH2.1] [F20-OP5] [F20-OS3.1]
7.3.4.2.	Independence of Support
(1)	[F20-OH2.1] [F20-OP5] [F20-OS3.1]
7.3.4.3.	Insulation of Support
(1)	[F80-OH1.1] [F80-OH2.1, OH2.2] [F80-OP5] [F80-OS3.1]
7.3.4.4.	Support for Vertical Piping
(1), (2)	[F20-OH1.1] Applies to vent piping. [F20-OH2.1] Applies to drainage piping. [F20-OH2.2] Applies to water piping. [F20-OP5] [F20-OS3.1]
7.3.4.5.	Support for Horizontal Piping
(1) to (3)	[F20-OH1.1] Applies to vent piping. [F20, F81-OH2.1] Applies to drainage piping. [F20-OH2.2] Applies to water piping. [F20-OP5] [F20-OS3.1]
(4)	
(5)	[F20-OH1.1] Applies to vent piping. [F20, F81-OH2.1] Applies to drainage piping. [F20-OH2.2] Applies to water piping. [F20-OP5] [F20-OS3.1]
(6)	[F20-OH1.1] Applies to vent piping. [F20, F81-OH2.1] Applies to drainage piping. [F20-OH2.2] Applies to water piping. [F20-OP5] [F20-OS3.1]
7.3.4.6.	Support for Underground Horizontal Piping
(1)	[F20-OE] Applies to drainage piping. [F20, F81-OH2.1] Applies to drainage piping. [F20-OH2.2] Applies to water piping. [F20-OP5] [F20-OS3.1]
(2)	[F20-OE] Applies to drainage piping. [F20-OH1.1] Applies to vent piping. [F20, F81-OH2.1] Applies to drainage piping. [F20-OH2.2] Applies to water piping. [F20-OP5] [F20-OS3.1]
7.3.4.7.	Support for Vent Pipe Above a Roof
(1)	[F20-OH1.1] [F61, F81-OP2.3] [F81-OS3.1]

Acceptable Solution	Objective and Functional Statement
7.3.4.8.	Compression Fittings
(1)	[F20-OH2.1, OH2.2]
	[F20-OP5]
	[F20-OS3.1]
7.3.4.9.	Thrust Restraint of Water Service Pipes
(1)	[F20, F81-OH2.2]
	[F20, F81-OP5]
(2)	[F20, F81-OH2.2]
(3)	[F20, F81-OH2.2]
(4)	[F20, F81-OH2.2]
7.3.5.1.	Backfill of Pipe Trench
(1)	[F20-OE]
	[F81-OH2.1]
	[F81-OP5]
7.3.5.2.	Protection of Non-Metallic Pipe
(1)	[F20-OE]
	[F81-OH2.1]
	[F81-OP5]
7.3.5.3.	Isolation from Loads
(1)	[F20-OE] Applies to underground drainage piping.
	[F81-OH2.1]
	[F81-OP5]
7.3.5.4.	Protection from Frost
(1)	[F20-OE] Applies to underground drainage piping.
	[F81-OH2.1]
	[F81-OP5]
7.3.5.5.	Protection from Mechanical Damage
(1)	[F81-OH1.1] Applies to venting system.
	[F81-OH2.1] Applies to drainage system.
	[F81-OH2.2] Applies to water system.
	[F81-OP5]
7.3.5.6.	Protection from Condensation
(1)	[F63-OH2.4]
	[F63-OP2.3]
7.3.5.7.	Spatial Separation
(1)	[F46-OH2.2]
	[F46-OP5]
(2)	[F46-OH2.2]
	[F46-OP5]
(3)	
(4)	[F46-OH2.2]
	[F46-OP5]
7.3.6.1.	Tests and Inspection of Drainage or Venting Systems
(1) to (4)	[F81-OH1.1] Applies to venting systems.
	[F81-OH2.1] Applies to drainage systems.
	[F81-OP5] Applies to drainage systems.
(5)	[F81-OH2.1] Applies to drainage systems.
(6)	[F22-OS2.6]
	[F36-OS3.6]
7.3.6.2.	Tests of Pipes in Drainage Systems
(1)	[F81-OE] Applies to underground drainage piping.
	[F81-OH2.1]
	[F81-OP5] Applies to drainage systems.

e6.1

Acceptable Solution	Objective and Functional Statement
7.3.6.3.	Tests of Venting Systems
(1)	[F81-OH1.1]
7.3.6.4.	Water Tests in Drain, Waste and Vent Systems
(1)	[F81-OH1.1] Applies to venting systems. [F81-OH2.1] Applies to drainage systems. [F81-OP5] Applies to drainage systems.
(2)	[F81-OH1.1] Applies to venting systems. [F81-OH2.1] Applies to drainage systems. [F81-OP5] Applies to drainage systems.
7.3.6.5.	Air Tests
(1)	[F81-OH1.1] Applies to venting systems. [F81-OH2.1] Applies to drainage systems. [F81-OP5] Applies to drainage systems.
7.3.6.6.	Final Tests
(1)	[F81-OH1.1] Applies to venting systems. [F81-OH2.1] Applies to drainage systems. [F81-OP5] Applies to drainage systems.
(2)	
7.3.6.7.	Ball Tests
(1)	[F81-OH2.1]
(2)	[F81-OH2.1]
7.3.7.1.	Application of Tests
(1)	[F81-OP5]
(2)	
(3)	[F81-OP5]
(4)	[F81-OP5]
7.3.7.2.	Tests of Potable Water Systems
(1)	[F20-OP5]
7.3.7.3.	Water Tests
(1)	[F81-OP5]
(2)	[F46-OH2.2]
7.4.1.1.	Application of Drainage Systems
(1)	
7.4.2.1.	Connections to Sanitary Drainage Systems
(1)	[F81-OH1.1] [F41, F43-OH2.1, OH2.4]
(2)	[F81-OH1.1] [F43-OH2.1, OH2.4]
(3)	[F81-OH1.1]
(4)	[F81-OH1.1]
(5)	[F81-OH1.1]
7.4.2.2.	Connection of Overflows from Rainwater Tanks
(1)	[F40-OE]
7.4.2.3.	Direct Connections
(1)	[F81-OH2.1]
(2)	[F81-OH2.1, OH2.4]
(3)	[F81-OH2.4]
(4)	[F81-OH2.4]
7.4.3.1.	Plumbing Fixtures
(1)	[F41-OH1.1] [F40, F41-OH2.1, OH2.4] [F80-OP2.3]

Acceptable Solution	Objective and Functional Statement
7.4.3.2.	Restricted Locations of Indirect Connections and Traps
(1)	[F81-OH2.1, OH2.4]
7.4.3.3.	Equipment Restrictions Upstream of Interceptors
(1)	[F81-OH2.1]
(2)	
7.4.3.4.	Fixtures Located in Chemical Storage Locations
(1)	[F44-OE]
	[F44-OH5]
	[F01-OP1.1]
	[F81-OP2.3]
	[F01, F81-OS1.1]
	[F32-OS3.3] [F44-OS3.4]
7.4.3.5.	Macerating Toilet
(1)	[F72-OH2.3]
7.4.3.6.	Drains Serving Elevator Pits
(1)	[F43-OH1.1]
	[F43-OH2.1]
	[F62-OP2.3]
	[F62-OP5]
7.4.4.1.	Sewage Treatment
(1)	[F81-OE] Applies to underground drainage piping.
	[F81-OH2.1]
	[F81-OP2.3]
	[F81-OP5]
	[F44-OS3.4]
7.4.4.2.	Protection for Drainage System
(1)	[F81-OE] Applies to underground drainage piping.
	[F81-OH2.1]
	[F81-OH5]
7.4.4.3.	Interceptors
(1)	[F81, F112-OE].
	[F111-OE] Applies to drainage systems served by a sewage system.
	[F81-OH2.1]
(2)	[F44, F81, F112-OE].
	[F111-OE] Applies to drainage systems served by a sewage system.
	[F81-OH2.1]
	[F44-OH5]
	[F01-OP1.1]
	[F01-OS1.1]
(3)	
(4)	[F81-OH2.1]
	[F111-OE] Applies to drainage systems served by a sewage system.
(5)	[F44-OE] Applies to oil interceptors. [F81, F112-OE]
	[F111-OE] Applies to drainage systems served by a sewage system.
	[F81-OH2.1]
	[F44-OH5] Applies to oil interceptors.
	[F01-OP1.1] Applies to oil interceptors.
	[F01-OS1.1] Applies to oil interceptors.
(6)	[F44-OE] Applies to oil interceptors. [F81, F112-OE]
	[F111-OE] Applies to drainage systems served by a sewage system.
	[F81-OH2.1]
	[F44-OH5] Applies to oil interceptors.

Acceptable Solution	Objective and Functional Statement
(6) (Cont'd)	[F01-OP1.1] Applies to oil interceptors. [F01-OS1.1] Applies to oil interceptors
(7)	[F81, F112-OE] [F111-OE] Applies to drainage systems served by a sewage system. [F81-OH2.1]
(8)	[F81, F112-OE] [F111-OE] Applies to drainage systems served by a sewage system. [F81-OH2.1]
(9)	[F44-OE] Applies to oil interceptors. [F81, F112-OE] [F111-OE] Applies to drainage systems served by a sewage system. [F81-OH2.1] [F44-OH5] Applies to oil interceptors. [F01-OP1.1] Applies to oil interceptors. [F01-OS1.1] Applies to oil interceptors.
(10)	
7.4.4.4.	Neutralizing and Dilution Tanks
(1)	[F40-OE] [F80-OH2.1] [F40-OH5] [F81-OP2.3] [F80-OP5] [F40, F80-OS3.4]
(2)	[F40-OE] [F80-OH2.1] [F40-OH5] [F81-OP2.3] [F80-OP5] [F40, F80-OS3.4]
7.4.5.1.	Traps for Sanitary Drainage Systems
(1)	[F81-OH1.1] [F42-OH2.5]
(2)	
(3)	
(4)	
(5)	[F81-OH1.1]
(6)	[F81-OH1.1] [F42-OH2.5]
7.4.5.2.	Traps for Storm Drainage Systems
(1)	[F81-OH1.1]
7.4.5.3.	Connection of Subsoil Drainage Pipe to a Sanitary Drainage System
(1)	[F40-OH1.1] [F40-OH2.1]
(2)	
(3)	[F81-OH1.1] [F81-OH2.1]
7.4.5.4.	Location and Cleanout for Building Traps
(1)	[F81-OH2.1]
7.4.5.5.	Trap Seals
(1)	[F81-OH1.1] [F42-OH2.5]
(2)	[F81-OH1.1] [F42-OH2.5]

Acceptable Solution	Objective and Functional Statement
7.4.6.1.	Separate Systems
(1)	[F40-OR1]
(2)	[F81-OH1.1] [F41, F81-OH2.1]
7.4.6.2.	Location of Soil or Waste Pipes
(1)	[F81-OH2.1, OH2.2, OH2.4] (a), (b) [F46-OH2.2]
7.4.6.3.	Sumps or Tanks
(1)	[F81-OH2.1]
(2)	[F81-OH1.1] [F81-OH2.1]
(3)	[F72-OH2.1] [F81-OH2.1]
(4)	[F81-OH2.1]
(5)	[F81-OH2.1]
(6)	[F81-OH2.1]
(7)	[F81-OH2.1]
(8)	[F81-OH2.1]
7.4.6.4.	Protection from Backflow
(1)	[F81-OH1.1] [F81-OH2.1]
(2)	[F81-OH1.1] [F81-OH2.1]
(3)	[F81-OH2.1]
(4)	
(5)	[F40-OH1.1] [F40-OH2.1]
7.4.6.5.	Mobile Home Sewer Service
(1)	[F81-OH2.1]
7.4.6.6.	Building Drain Ends
(1)	
7.4.7.1.	Cleanouts for Drainage Systems
(1)	[F81-OH2.1]
(2)	[F81-OH2.1]
(3)	[F81-OH2.1]
(4)	[F81-OH2.1]
(5)	[F81-OH2.1]
(6)	[F81-OH2.1]
(7)	[F81-OH2.1]
(8)	[F81-OH2.1]
(9)	[F81-OH2.1]
(10)	[F81-OH2.1]
7.4.7.2.	Size and Spacing of Cleanouts
(1)	[F81-OH2.1]
(2)	[F81-OH2.1]
(3)	[F81-OH2.1]
(4)	[F81-OH2.1]
(5)	[F81-OH2.1]
(6)	[F81-OH2.1]
7.4.7.3.	Manholes
(1)	[F20-OS3.1]
(2)	(a), (c) [F81-OH1.1]

Acceptable Solution	Objective and Functional Statement
(2) (Cont'd)	(a), (c) [F81-OS1.1] (b), [F20, F30, F80-OS3.1]
(3)	[F30-OS3.1] [F36-OS3.6]
(4)	[F81-OH2.1]
7.4.7.4.	Location of Cleanouts
(1)	[F81-OH2.1]
(2)	[F81-OH1.1] [F30-OS3.1]
(3)	
(4)	[F81-OH2.1]
(5)	[F81-OH2.1]
(6)	[F43-OH2.1] [F43-OH5]
7.4.8.1.	Minimum Slope
(1)	[F81-OH2.1]
(2)	
(3)	[F81-OH2.1]
7.4.8.2.	Length of Fixture Outlet Pipes
(1)	[F81-OH1.1]
7.4.9.1.	No Reduction in Size
(1)	[F81-OH2.1]
(2)	[F81-OH2.1]
(3)	
7.4.9.2.	Serving Water Closets
(1)	[F81-OH2.1]
(2)	[F81-OH2.1]
(3)	[F81-OH2.1]
(4)	[F81-OH2.1]
(5)	[F81-OH1.1, OH2.1, OP5]
7.4.9.3.	Size of Fixture Outlet Pipes
(1)	[F81-OH2.1]
(2)	[F81-OH2.1]
(3)	[F81-OH1.1] [F81-OP5]
7.4.9.4.	Minimum Size of Building Drains and Sewers
(1)	[F81-OH2.1]
(2)	[F81-OH2.1]
7.4.10.1.	Total Load on a Pipe
(1)	
7.4.10.2.	Hydraulic Loads for Fixtures
(1)	
(2)	
7.4.10.3.	Hydraulic Loads from Fixtures with Continuous or Semi-continuous Flow
(1)	
(2)	
(3)	
7.4.10.4.	Hydraulic Loads from Roofs or Paved Surfaces
(1)	
(2)	[F20, F81-OP5] (a), (d), (e) [F41, F81-OH2.4, OH2.5] (b), (c) [F20, F81-OS2.1]
(3)	[F20, F81-OP5]

Acceptable Solution	Objective and Functional Statement
7.4.10.5.	Conversion of Fixture Units to Litres and Gal/min
(1)	
(2)	
7.4.10.6.	Hydraulic Loads to Soil or Waste Pipes
(1)	[F81-OH2.1]
(2)	[F81-OH2.1]
(3)	[F81-OH2.1]
7.4.10.7.	Hydraulic Loads on Branches
(1)	[F81-OH2.1]
7.4.10.8.	Hydraulic Loads on Sanitary Horizontal Drain
(1)	[F81-OH2.1]
(2)	[F81-OH2.1]
7.4.10.9.	Hydraulic Loads on Horizontal Storm Drains
(1)	[F81-OH2.1]
7.4.10.10.	Rain Leaders
(1)	
(2)	[F62, F81-OH1.3]
(3)	[F62, F81-OH1.3]
7.5.1.1.	Venting for Traps
(1)	[F81-OH1.1]
(2)	[F81-OH1.1]
(3)	
(4)	
7.5.2.1.	Wet Venting
(1)	[F40, F81-OH1.1]
7.5.3.1.	Circuit Venting
(1)	[F40, F81-OH1.1]
(2)	[F40, F81-OH1.1]
(3)	[F40, F81-OH1.1]
(4)	[F40, F81-OH1.1]
(5)	[F40, F81-OH1.1]
(6)	[F40, F81-OH1.1]
(7)	[F40, F81-OH1.1]
(8)	[F40, F81-OH1.1]
(9)	[F40, F81-OH1.1]
(10)	[F40, F81-OH1.1]
(11)	
7.5.4.1.	Stack Vents
(1)	[F40, F81-OH1.1]
7.5.4.2.	Vent Stacks
(1)	[F40, F81-OH1.1]
(2)	
(3)	[F40, F81-OH1.1]
(4)	[F40, F81-OH1.1]
7.5.4.3.	Yoke Vents
(1)	[F40, F81-OH1.1]
(2)	[F40, F81-OH1.1]
(3)	[F40, F81-OH1.1]
(4)	
7.5.4.4.	Offset Relief Vents
(1)	[F40, F81-OH1.1]

Acceptable Solution	Objective and Functional Statement
7.5.4.5.	Fixtures Draining into Vent Pipes
(1)	[F40, F81-OH1.1]
7.5.5.1.	Venting of Sanitary Sewage Sumps
(1)	[F40, F81-OH1.1]
7.5.5.2.	Venting of Interceptors
(1)	[F40, F81-OH1.1] [F81-OH2.1] [F01, F40, F81-OP1.1] [F01, F40, F81-OS1.1]
(2)	[F40, F81-OH1.1] [F81-OH2.1] [F01, F40, F81-OP1.1] [F01, F40, F81-OS1.1]
(3)	[F40, F81-OH1.1] [F01, F40, F81-OP1.1] [F01, F40, F81-OS1.1]
(4)	[F40, F81-OH1.1] [F01, F40, F81-OP1.1] [F01, F40, F81-OS1.1]
(5)	[F40, F81-OH1.1] [F01, F40, F81-OP1.1] [F01, F40, F81-OS1.1]
(6)	[F40, F81-OH1.1] [F81-OH2.1]
(7)	[F40, F81-OH1.1] [F81-OH2.1]
(8)	[F40, F81-OH1.1] [F81-OH2.1] [F01, F40, F81-OP1.1] [F01, F40, F81-OS1.1]
7.5.5.3.	Venting of Corrosive Drain Piping and Dilution Tanks
(1)	[F81-OS3.4]
7.5.5.4.	Fresh Air Inlets
(1)	[F81-OH1.1]
7.5.5.5.	Provision for Future Installations
(1)	[F81-OH1.1] Applies to venting systems. [F81-OH2.1] Applies to drainage systems.
(2)	[F40, F81-OH1.1]
7.5.6.1.	Drainage of Vent Pipes
(1)	[F81-OH1.1]
(2)	[F81-OH1.1]
7.5.6.2.	Vent Pipe Connections
(1)	[F81-OH1.1]
(2)	[F81-OH1.1]
(3)	[F40, F81-OH1.1]
7.5.6.3.	Location of Vent
(1)	[F81-OH1.1]
(2)	[F81-OH2.1]
(3)	[F81-OH1.1]
(4)	[F40, F81-OH1.1]
(5)	

Acceptable Solution	Objective and Functional Statement
7.5.6.4.	Connection of Vents above Fixtures Served
(1)	[F81-OH1.1]
(2)	[F81-OH1.1]
7.5.6.5.	Terminals
(1)	[F81-OH1.1]
(2)	[F81-OH1.1]
(3)	
(4)	[F81-OH1.1]
(5)	[F81-OH1.1]
(6)	[F81-OH1.1]
(7)	[F20, F81-OH1.1]
(8)	[F61, F80-OH1.3] [F61, F80-OP2.3]
(9)	[F61-OH1.3] [F61-OP2.3]
(10)	[F81-OH1.1]
7.5.7.1.	General
(1)	[F81-OH1.1]
7.5.7.2.	Size Restriction
(1)	[F81-OH1.1]
(2)	[F81-OH1.1]
(3)	[F81-OH1.1]
7.5.7.3.	Additional Circuit Vents and Relief Vents
(1)	
(2)	[F81-OH1.1]
7.5.7.4.	Offset Relief Vents
(1)	[F81-OH1.1]
7.5.7.5.	Yoke Vents
(1)	[F81-OH2.1]
7.5.7.6.	Vent Pipes for Manholes
(1)	[F81-OH2.1]
7.5.7.7.	Vents for Sanitary Sewage Sumps or Tanks, Dilution Tanks and Macerating Toilet Systems
(1)	[F81-OH2.1]
(2)	[F81-OH2.1]
(3)	[F81-OH1.1]
7.5.8.1.	Hydraulic Loads Draining to Wet Vents
(1)	[F81-OH1.1]
(2)	[F81-OH1.1]
7.5.8.2.	Individual Vents and Dual Vents
(1)	[F81-OH1.1]
(2)	
7.5.8.3.	Branch Vents, Headers, Continuous Vents and Circuit Vents
(1)	[F81-OH1.1]
(2)	
(3)	
(4)	
(5)	
7.5.8.4.	Vent Stacks or Stack Vents
(1)	[F81-OH1.1]
(2)	
(3)	[F81-OH1.1]
(4)	[F81-OH1.1]

Acceptable Solution	Objective and Functional Statement
(5)	[F81-OH1.1]
7.5.8.5.	Lengths for other Vent Pipes
(1)	
7.5.9.1.	Air Admittance Valve as a Vent Terminal
(1)	
7.5.9.2.	Air Admittance Valves
(1)	[F40, F81-OH1.1] (a) [F140-OC]
(2)	[F40, F81-OH1.1]
(3)	[F40, F81-OH1.1]
7.5.9.3.	Installation Conditions
(1)	[F40, F81-OH1.1]
(2)	[F40, F81-OH1.1]
(3)	[F40, F81-OH1.1]
(4)	[F40, F81-OH1.1]
(5)	[F40, F81-OH1.1]
7.6.1.1.	Design, Fabrication and Installation
(1)	[F31-OS3.2]
(2)	[F31-OS3.2]
(3)	[F71-OH2.3]
7.6.1.2.	Drainage
(1)	[F81-OP5]
7.6.1.3.	Control and Shut-off Valves
(1)	[F81-OP5]
(2)	[F81-OP5]
(3)	[F81-OP5]
(4)	[F81-OP5]
(5)	[F81-OP5]
(6)	[F81-OP5]
7.6.1.4.	Shut-off Valves
(1)	[F81-OP5]
7.6.1.5.	Water Closets
(1)	[F81-OP5]
7.6.1.6.	Suites
(1)	[F70-OH2.2] [F81-OP5]
7.6.1.7.	Public Washrooms
(1)	[F81-OP5]
7.6.1.8.	Tanks
(1)	[F81-OP5]
7.6.1.9.	Protection for Exterior Water Supply
(1)	[F81-OP5]
7.6.1.10.	Check Valves
(1)	[F20, F81-OP5]
7.6.1.11.	Flushing Devices
(1)	[F72-OH2.1]
(2)	[F72-OH2.1]
7.6.1.12.	Relief Valves
(1)	[F20, F81-OP1.1] [F20, F81-OS1.1] [F20, F81-OS2.3]

Acceptable Solution	Objective and Functional Statement
(1) (Cont'd)	[F31, F81-OS3.2] Applies to pressure vessels containing hot water.
(2)	[F20, F81-OP1.1]
	[F20, F81-OS1.1]
	[F20, F81-OS2.3]
	[F31, F81-OS3.2]
(3)	
(4)	[F20, F81-OP1.1] [F20, F81-OS1.1] [F20, F81-OS2.3] (b) [F31, F81-OS3.2]
(5)	[F20, F81-OP1.1]
	[F20, F81-OS1.1]
	[F20, F81-OS2.3]
	[F31, F81-OS3.2]
	(b) [F81-OH2.2] Applies to the size of air break.
(6)	[F20, F81-OP1.1]
	[F20, F81-OS1.1]
	[F20, F81-OS2.3]
	[F31, F81-OS3.2]
(7)	[F20, F81-OP1.1]
	[F20, F81-OS1.1]
	[F20, F81-OS2.3]
	[F31, F81-OS3.2]
7.6.1.13.	Solar Domestic Hot Water Systems
(1)	[F70-OH2.2]
	[F20-OS2.2, OS2.3]
	[F31-OS3.2] [F81-OS3.4]
(2)	[F61-OH1.3]
	[F70-OH2.2]
	[F20-OS2.2, OS2.3]
	[F31-OS3.2] [F81-OS3.4]
7.6.1.14.	Water Hammer
(1)	[F20-OH4]
	[F20, F81-OP5]
	[F20, F81-OS3.2]
7.6.1.15.	Mobile Home Water Service
(1)	[F46, F70-OH2.2]
7.6.1.16.	Thermal Expansion
(1)	[F20, F46, F81-OP5]
7.6.2.1.	Connection of Systems
(1)	[F81-OH2.1] [F46, F70, F81-OH2.2]
(2)	[F46, F70, F81-OH2.2]
7.6.2.2.	Back-Siphonage
(1)	[F81-OH2.1] [F46, F70, F81-OH2.2]
(2)	[F81-OH2.1] [F46, F70, F81-OH2.2]
(3)	[F81-OH2.1] [F46, F70, F81-OH2.2]
7.6.2.3.	Protection from Backflow
(1)	[F81-OH2.1] [F46, F70, F81-OH2.2]
(2)	
(3)	
7.6.2.4.	BackFlow from Fire Protection Systems.
(1)	
(2)	[F81-OH2.1] [F46, F70, F81-OH2.2]

Acceptable Solution	Objective and Functional Statement
(3)	[F02, F12, F81-OP1.2] [F02, F12, F81-OS1.2]
(4)	[F81-OH2.1] [F46, F70, F81-OH2.2]
7.6.2.5.	Backflow from Buildings with a Solar Domestic Hot Water System
(1)	[F70, F81, F46-OH2.1, OH 2.2, OH2.3]
(2) to (4)	
7.6.2.6.	Premise Isolation
(1)	[F81-OH2.1] [F46, F70, F81-OH2.2]
(2)	
(3)	[F46, F70, F81-OH2.2]
7.6.2.7.	Reserved
7.6.2.8.	Cleaning of Systems
(1)	[F81-OH2.1] [F46, F70, F81-OH2.2]
7.6.2.9.	Air Gap
(1)	[F81-OH2.1] [F46, F70, F81-OH2.2]
(2)	[F81-OH2.1] [F46, F70, F81-OH2.2]
7.6.2.10.	Vacuum Breakers and Flood Levels
(1)	
(2)	[F81-OH2.1] [F46, F70, F81-OH2.2]
(3)	[F81-OH2.1] [F46, F70, F81-OH2.2]
(4)	[F81-OH2.1] [F46, F70, F81-OH2.2]
7.6.3.1.	Design
(1)	[F70, F81-OH2.2]
(2)	[F70-OH2.2]
(3)	[F70, F81-OH2.2] [F40-OH2.1, OH2.4]
7.6.3.2.	Hydraulic Load
(1)	[F70, F81-OH2.2]
(2)	[F70, F81-OH2.2]
(3)	[F70, F81-OH2.2]
(4)	[F70, F81-OH2.2]
7.6.3.3.	Static Pressure
(1)	[F20, F81-OP1.1] [F20, F81-OP5] [F20, F81-OS1.1] [F20, F81-OS2.3] [F31, F81-OS3.2] Applies to pipes containing hot water
7.6.3.4.	Size
(1)	[F70, F81-OH2.2]
(2)	[F70, F81-OH2.2]
(3)	
(4)	[F70, F81-OH2.2]
(5), (6)	[F71, F72-OH2.1, OH2.3]
7.6.4.1.	Water Supply Fittings
(1)	[F130-OR1]
(2)	
(3)	[F130-OR1]
(4)	[F30-OS3.1] [F31-OS3.2]
(5)	[F130-OR1]
7.6.4.2.	Plumbing Fixtures
(1)	[F130-OR1]
(2)	[F130-OR1]

F6.1

F11.1

F11.1

Acceptable Solution	Objective and Functional Statement
(3)	[F130-OR1]
(4)	
(5)	[F130-OR1]
7.6.5.1.	Maximum Temperature of Hot Water
(1)	[F31-OS3.2]
(2)	[F31-OS3.2]
7.6.5.2.	Showers
(1)	[F31-OH1.2] [F30-OS3.1] [F31-OS3.2]
(2)	
(3)	
(4)	[F31-OH1.2] [F31-OS3.2]
7.6.5.3.	Temperature Control Devices
(1)	[F31-OH1.2] [F31-OS3.2]
7.7.1.1.	Non-Potable Connection
(1)	[F46-OH2.2]
(2)	[F81-OH2.1] [F46, F70, F81-OH2.2]
(3)	[F81-OH2.1] [F46, F70, F81-OH2.2]
7.7.2.1.	Markings Required
(1)	[F46, F81-OH2.2]
(2)	[F46, F81-OH2.2]
(3)	[F46, F81-OH2.2]
7.7.3.1.	Pipes
(1)	[F81-OH2.1, OH2.2, OH2.4] (c), (d) [F46-OH2.2]
7.7.3.2.	Outlets
(1)	[F46-OH2.2] [F40-OH2.4]
7.7.4.1.	Conformance to Standards
(1)	[F81, F82-OH2.1, OH2.2, OH2.4] [F130-OR1]

Table 8
Objectives and Functional Statements Attributed to the Acceptable Solutions in Part 8 of Division B

Acceptable Solution	Objective and Functional Statement
8.1.1.1.	Scope
(1)	
8.1.1.2.	Definitions
(1)	
8.1.2.1.	Classification of Systems
(1)	
8.1.2.2.	Operation and Maintenance
(1)	
8.1.3.1.	Discharge
(1)	[F81, F110, F111-OE] [F81, F110, F111-OH5]
(2)	
(3)	
(4)	
(5)	
(6)	
(7)	[F81, F110, F111-OE] [F81, F110, F111-OH5]
(8)	[F81, F111-OE] [F81, F111-OH5]
8.2.1.1.	Scope
(1)	
8.2.1.2.	Site Evaluation
(1)	[F110, F111, F112-OE] [F110, F111, F112-OH5]
(2)	
(3)	
8.2.1.3.	Sewage System Design Flows
(1)	
(2)	
(3)	
(4)	
8.2.1.4.	Clearances
(1)	
(2)	[F110, F112-OE] [F110, F112-OH5]
(3)	[F110, F112-OE] [F110, F112-OH2.1] [F110, F112-OH5]
(4)	[F110, F111, F112-OE] [F110, F111, F112-OH5]
8.2.1.5.	Clearance Distances for Class 1, 2 and 3 Sewage Systems
(1)	[F110, F112-OE] [F110, F112-OH5]
8.2.1.6.	Clearances for a Class 4 or 5 Sewage System
(1)	[F110, F112-OE] [F110, F112-OH2.1] [F110, F112-OH5]

Acceptable Solution	Objective and Functional Statement
(2)	[F110, F112-OE] [F110, F112-OH2.1] [F110, F112-OH5]
(3)	[F110-OE] [F110-OH2.1] [F110-OH5]
8.2.2.1.	Application
(1)	
8.2.2.2.	Tanks
(1)	[F110, F111, F112-OE] [F110, F111, F112-OH5] [F20-OP2.3]
(2)	[F110, F111, F112-OE] [F110, F111, F112-OH5] [F20-OP2.3]
(3)	
(4)	
(5)	[F82, F111-OE] [F82, F111-OH2.1] [F82, F111-OH5]
(6)	[F20-OP2.3]
(7)	[F81-OP2.6]
8.2.2.3.	Septic Tanks
(1)	[F111-OE] [F111-OH2.1] [F111-OH5]
(2)	[F111, F112-OE] [F111, F112-OH2.1] [F111, F112-OH5]
(3)	[F111, F112-OE] [F111, F112-OH2.1] [F111, F112-OH5]
(4)	[F111, F112-OE] [F111, F112-OH2.1] [F111, F112-OH5] (e) [F110-OE] (e) [F110-OH5]
(5)	[F111, F112-OE] [F111, F112-OH2.1] [F111, F112-OH5]
(6)	[F111, F112-OE] [F111, F112-OH2.1] [F111, F112-OH5]
(7)	[F111, F112-OE] [F111, F112-OH2.1] [F111, F112-OH5]
(8)	[F111, F112-OE] [F111, F112-OH2.1] [F111, F112-OH5]
(9)	[F82, F111-OE] [F82, F111-OH2.1] [F82, F111-OH5]

Acceptable Solution	Objective and Functional Statement
(10)	[F82, F111-OE] [F82, F111-OH2.1] [F82, F111-OH5]
(11)	[F82, F111-OE] [F82, F111-OH2.1] [F82, F111-OH5]
8.2.2.4.	Holding Tanks
(1)	[F82, F111-OE] [F82, F111-OH2.1] [F82, F111-OH5]
(2)	[F111-OE] [F111-OH2.1] [F111-OH5]
(3)	
(4)	
8.3.1.1.	Scope
(1)	
8.3.1.2.	Application
(1)	[F111, F112-OE] [F111, F112-OH2.1] [F111, F112-OH5]
(2)	
(3)	[F110-OE] [F110-OH5]
8.3.2.1.	Construction Requirements
(1)	(a), (b) [F42-OH2.5] (c), (d), (h) [F40-OH2.4] (e) [F101-OH6] (f), (g) [F50-OH1.1] (f), (g) [F42-OH2.5]
8.3.3.1.	Construction Requirements
(1)	(a) [F110, F112-OE] (a) [F110, F112-OH5] (b) [F20-OS2.2] (b), (d) [F113-OH2.6] (c) [F112-OE] (c) [F112-OH5] (d) [F110-OE]
8.3.4.1.	Construction Requirements
(1)	(a) [F40-OH2.4] [F113-OH2.6] (b) [F113-OH2.6] (c) [F111-OE] (c) [F111-OH5]
8.3.5.1.	Construction Requirements
(1)	(a) [F113-OH2.6] (b) [F40-OH2.4] (c) [F20-OS2.1]
8.4.1.1.	Scope
(1)	
8.4.1.2.	Application
(1)	[F110-OE] [F110-OH5]

Acceptable Solution	Objective and Functional Statement
(2)	
8.4.2.1.	Construction Requirements
(1)	[F110, F112-OE] [F110, F112-OH5]
(2)	[F113-OH2.6] [F20-OS2.2]
(3)	[F112-OE] [F112-OH5]
(4)	[F82-OE] [F42-OH2.5] [F113-OH2.6] [F82-OH5] [F30-OS3.1]
(5)	[F113-OH2.6]
(6)	[F111-OE] [F111-OH5]
(7)	[F112-OE] [F112-OH5]
8.4.2.2.	Maximum Sewage Flow
(1)	[F110, F112-OE] [F110, F112-OH5]
8.4.2.3.	Sizing
(1)	[F110, F112-OE] [F110, F112-OH5]
8.5.1.1.	Scope
(1)	
8.5.1.2.	Application
(1)	[F110, F112-OE] [F110, F112-OH5]
(2)	[F112-OE] [F112-OH5]
8.5.2.1.	Construction Requirements
(1)	[F110, F112-OE] [F110, F112-OH5]
(2)	[F113-OH2.6] [F20-OS2.2]
(3)	[F112-OE] [F112-OH5]
(4)	[F82-OE] [F42-OH2.5] [F113-OH2.6] [F82-OH5] [F30-OS3.1]
(5)	[F30-OS3.1]
(6)	[F113-OH2.6]
(7)	[F111-OE] [F111-OH5]
(8)	[F112-OE] [F112-OH5]
8.6.1.1.	Scope
(1)	
8.6.1.2.	General Requirements
(1)	[F112-OE] [F112-OH5]

Acceptable Solution	Objective and Functional Statement	
8.6.1.3.	Pumps and Siphons	
R6.1	(1)	[F110, F111, F112-OE] [F110, F111, F112-OH2.1] [F110, F111, F112-OH5]
	(1.1)	[F110, F111-OE] [F110, F111-OH2.1] [F110, F111-OH5]
	(2)	[F110, F111, F112-OE] [F110, F111, F112-OH5]
	(3)	[F111, F113-OE] [F111, F113-OH5]
	(4)	[F112-OE] [F112-OH5]
	(5)	[F110, F111-OE] [F110, F111-OH2.1] [F110, F111-OH5]
	8.6.2.1.	Septic Tank Systems
	(1)	[F110, F111-OE] [F110, F111-OH5]
	(2)	[F110, F111-OE] [F110, F111-OH5]
	(3)	[F82-OE] [F82-OH2.1]
	8.6.2.2.	Other Treatment Units
	(1)	[F110-OE] [F110-OH5]
(2)	[F110, F111-OE] [F110, F111-OH5]	
(3)	[F111-OE] [F111-OH2.1] [F111-OH5]	
(4)	[F111-OE] [F111-OH2.1] [F111-OH5]	
(5)		
(6)	[F82, F111-OE] [F82, F111-OH2.1] [F82, F111-OH5]	
8.7.1.1.	Application Scope	
R3	(1)	[F110, F111-OE] [F110, F111-OH2.1] [F110, F111-OH5]
	8.7.1.2.	Limitation on Installation
	(1)	[F110, F111, F112-OE] [F110, F111, F112-OH2.1] [F110, F111, F112-OH5]
	8.7.2.1.	General Requirements
	(1)	[F110, F111-OE] [F110, F111-OH2.1] [F110, F111-OH5]

Acceptable Solution	Objective and Functional Statement
(2)	[F104, F110, F111-OE] [F104, F110, F111-OH2.1] [F104, F110, F111-OH5] [F104, F110, F111-OR2]
(3)	[F110, F111-OE] [F110, F111-OH2.1] [F110, F111-OH5]
(4)	[F110, F111-OE] [F110, F111-OH2.1] [F110, F111-OH5]
(5)	[F110, F111-OE] [F110, F111-OH2.1] [F110, F111-OH5]
R3	8.7.2.2. Distribution Pipes within Leaching Beds
(1)	
(2)	[F111-OE]
R6.1	8.7.2.3. Leaching Chambers within Leaching Beds
(1)	
(2)	
(3)	[F111, F112-OE] [F111, F112-OH2.1] [F111, F112-OH5]
(4)	[F111-OE]
	8.7.3.1. Length of Distribution Pipe
(1)	[F110, F111-OE] [F110, F111-OH2.1] [F110, F111-OH5]
(2)	[F110-OE] [F110-OH5]
(3)	[F110-OE] [F110-OH5]
(4)	[F110-OE] [F110-OH5]
R6.1	8.7.3.1A. Length of Leaching Chamber
(1)	[F110, F111-OE] [F110, F111-OH2.1] [F110, F111-OH5]
(2)	[F110, F111-OE] [F110, F111-OH2.1] [F110, F111-OH5]
(3)	[F110-OE] [F110-OH2.1] [F110-OH5]
(4)	[F110-OE] [F110-OH5]
	8.7.3.2. Absorption Trenches
(1)	[F110, F111-OE] [F110, F111-OH2.1] [F110, F111-OH5]
(2)	[F110, F111-OE] [F110, F111-OH2.1] [F110, F111-OH5]

Γ6.1

Γ6.1

Acceptable Solution	Objective and Functional Statement
8.7.3.3.	Distribution Pipe
(1)	[F111-OE] [F111-OH5]
(2)	[F111-OE] [F111-OH5]
(3)	[F110, F111-OE] [F110, F111-OH2.1] [F110, F111-OH5]
(4)	[F110, F111-OE] [F110, F111-OH2.1] [F110, F111-OH5]
(5)	
(6)	
8.7.3.4.	Leaching Chamber
(1)	[F111-OE] [F111-OH5]
(2)	[F111-OE] [F111-OH5]
(3)	[F110, F111-OE] [F110, F111-OH2.1] [F110, F111-OH5]
8.7.4.1.	Loading Requirements
(1)	[F110, F111-OE] [F110, F111-OH2.1] [F110, F111-OH5]
8.7.4.2.	Construction Requirements
(1)	[F110, F111-OE] [F110, F111-OH2.1] [F110, F111-OH5]
(2)	[F110, F111-OE] [F110, F111-OH2.1] [F110, F111-OH5]
(3)	[F110, F111-OE] [F110, F111-OH2.1] [F110, F111-OH5]
(4)	
(5)	[F110, F111-OE] [F110, F111-OH2.1] [F110, F111-OH5]
(6)	[F110, F111-OE] [F110, F111-OH2.1] [F110, F111-OH5]
(7)	[F110, F111-OE] [F110, F111-OH2.1] [F110, F111-OH5]
(8)	[F110, F111-OE] [F110, F111-OH2.1] [F110, F111-OH5]
(9)	[F110, F111-OE] [F110, F111-OH2.1] [F110, F111-OH5]

Acceptable Solution	Objective and Functional Statement
(10)	[F110, F111-OE] [F110, F111-OH2.1] [F110, F111-OH5]
(11)	[F110, F111-OE] [F110, F111-OH2.1] [F110, F111-OH5]
8.7.5.1.	Application
(1)	[F110, F111-OE] [F110, F111-OH2.1] [F110, F111-OH5]
8.7.5.2.	Loading Requirements
(1)	[F110, F111-OE] [F110, F111-OH2.1] [F110, F111-OH5]
(2)	[F110, F111-OE] [F110, F111-OH2.1] [F110, F111-OH5]
(3)	[F110, F111, F112-OE] [F110, F111, F112-OH2.1] [F110, F111, F112-OH5]
(4)	[F110, F111, F112-OE] [F110, F111, F112-OH2.1] [F110, F111, F112-OH5]
(5)	[F110, F111, F112-OE] [F110, F111, F112-OH2.1] [F110, F111, F112-OH5]
8.7.5.3.	Construction Requirements
(1)	
(2)	[F110, F112-OE] [F110, F112-OH2.1] [F110, F112-OH5]
(3)	[F110, F112-OE] [F110, F112-OH2.1] [F110, F112-OH5]
(4)	[F110, F111, F112-OE] [F110, F111, F112-OH2.1] [F110, F111, F112-OH5]
(5)	[F110, F111-OE] [F110, F111-OH2.1] [F110, F111-OH5]
(6)	[F110, F111, F112-OE] [F110, F111, F112-OH2.1] [F110, F111, F112-OH5]
(7)	
8.7.6.1.	Construction Requirements
(1)	[F112-OE] [F112-OH5]
(2)	[F110, F111, F112-OE] [F110, F111, F112-OH2.1] [F110, F111, F112-OH5]

Acceptable Solution	Objective and Functional Statement
(3)	[F110, F111-OE] [F110, F111-OH2.1] [F110, F111-OH5]
(4)	[F20-OS2.2]
(5)	[F110, F111-OE] [F110, F111-OH2.1] [F110, F111-OH5]
(6)	
8.7.7.1.	Construction Requirements
(1)	[F112-OE] [F112-OH5]
(2)	[F110, F111-OE] [F110, F111-OH2.1] [F110, F111-OH5]
(3)	[F110, F112-OE] [F110, F112-OH2.1] [F110, F112-OH5]
(4)	[F110, F112-OE] [F110, F112-OH2.1] [F110, F112-OH5]
(5)	[F110, F111-OE] [F110, F111-OH2.1] [F110, F111-OH5]
R3	(6) [F110, F111-OE] [F110, F111-OH2.1] [F110, F111-OH5]
R6.1	(6.1) [F110, F111-OE] [F110, F111-OH2.1] [F110, F111-OH5]
R3	(7) [F110, F111-OE] [F110, F111-OH2.1] [F110, F111-OH5]
R3	(8) [F111-OE] [F111-OH5]
R6.1	(8.1) [F111-OE] [F111-OH5]
R3	(9) [F110, F112-OE] [F110, F112-OH2.1] [F110, F112-OH5]
R3	8.7.7.2. Construction Requirements
(1)	
(2)	[F111-OE]
8.7.8.1.	General Requirements
(1)	
(2)	[F110, F111-OE] [F110, F111-OH2.1] [F110, F111-OH5]

Acceptable Solution	Objective and Functional Statement
8.7.8.2.	Construction Requirements
(1)	[F112-OE] [F112-OH5]
(2)	[F110, F112-OE] [F110, F112-OH2.1] [F110, F112-OH5]
(3)	[F110, F112-OE] [F110, F112-OH5]
(4)	[F110, F111, F112-OE] [F110, F111, F112-OH2.1] [F110, F111, F112-OH5]
(5)	[F110, F111, F112-OE] [F110, F111, F112-OH2.1] [F110, F111, F112-OH5]
r3	(6)
r3	(7)
r3	(8)
r3	(9)
r3	(10)
8.7.8.3.	Design Requirements
(1)	[F110, F111-OE] [F110, F111-OH2.1] [F110, F111-OH5]
(2)	[F110, F111-OE] [F110, F111-OH2.1] [F110, F111-OH5]
(3)	[F110, F111-OE] [F110, F111-OH2.1] [F110, F111-OH5]
(4)	[F110, F111-OE] [F110, F111-OH2.1] [F110, F111-OH5]
8.8.1.1	Prohibited Installation
(1)	
8.8.1.2.	Acceptable Installation
(1)	[F110-OE] [F110-OH5]
(2)	[F82, F110-OE] [F82, F110-OH5]

Acceptable Solution	Objective and Functional Statement
8.8.2.1.	Construction Requirements
(1)	[F82, F110-OE] [F82, F110-OH5]
(2)	[F82, F110-OE] [F82, F110-OH5]
(3)	[F110-OE] [F110-OH5]
(4)	[F110-OE] [F110-OH5]
8.8.2.2.	Sizing of Holding Tanks
(1)	[F110, F111-OE] [F110, F111-OH2.1] [F110, F111-OH5]
8.9.1.1.	Scope
(1)	
8.9.1.2.	General Requirements for Operation and Maintenance
(1)	[F110-OE] [F110-OH5]
(2)	
8.9.2.1.	Scope
(1)	
8.9.2.2.	General
(1)	[F110, F111-OE] [F110, F111-OH2.1] [F110, F111-OH5]
8.9.2.3.	Class 4 Sewage Systems
(1)	[F110, F111-OE] [F110, F111-OH2.1] [F110, F111-OH5]
(2)	[F82, F110-OE] [F82, F110-OH5]
(3)	
8.9.2.4.	Sampling of Treatment Units
(1)	[F82, F110-OE] [F82, F110-OH5]
(2)	[F82, F110-OE] [F82, F110-OH5]
(3)	[F82, F110-OE] [F82, F110-OH5]
(4)	[F82, F110-OE] [F82, F110-OH5]
8.9.2.5.	Class 5 Sewage Systems
(1)	[F82, F110-OE] [F82, F110-OH5]
(2)	[F110-OE] [F110-OH5]

Acceptable Solution	Objective and Functional Statement
8.9.3.1.	Scope
(1)	
8.9.3.2.	General
(1)	[F110, F111-OE]
	[F110, F111-OH2.1]
	[F110, F111-OH5]
(2)	[F110, F111-OE]
	[F110, F111-OH2.1]
	[F110, F111-OH5]
8.9.3.3.	Interceptors
(1)	[F110, F111-OE]
	[F110, F111-OH2.1]
	[F110, F111-OH5]
8.9.3.4.	Class 4 Sewage Systems
(1)	[F110, F111-OE]
	[F110, F111-OH2.1]
	[F110, F111-OH5]
8.9.3.5.	Pressurized Distribution Systems
(1)	[F110, F111-OE]
	[F110, F111-OH2.1]
	[F110, F111-OH5]

Table 9
Objectives and Functional Statements Attributed to the Acceptable Solutions in Part 9 of Division B

Acceptable Solution	Objectives and Functional Statements
9.1.1.1.	Scope
(1)	
9.1.1.2.	Signs
(1)	
9.1.1.3.	Self-Service Storage Buildings
(1)	
9.1.1.4.	Tents and Air-Supported Structures
(1)	
(2)	
9.1.1.5.	Proximity to Existing Above Ground Electrical Conductors
(1)	
9.1.1.6.	Food Premises
(1)	
9.1.1.7.	Radon
(1)	[F40, F50-OH1.1]
9.1.1.8.	Building in Flood Plains
(1)	(a) [F20-OP2.1]
	(a) [F20-OS2.1, OS2.3]
	(a) [F61-OH1.3]
	(b) [F10, F12-OS3.1] [F10, F30-OS3.7]
9.1.1.9.	Site Assembled and Factory-Built Buildings
e4 (1), (2)	
9.1.1.10.	Public Pools and Public Spas
(1)	
9.1.1.11.	Shelf and Rack Storage Systems
(1)	
r6 9.1.1.12.	Houses
(1)	
9.3.1.1.	General
(1)	[F20-OP2.1, OP2.4] [F21-OP2.3, OP2.4] [F80-OP2.3] [F20-OP2.3] Applies to elements that support or are part of an environmental separator. [F20, F21, F80-OH1.1] Applies where concrete supports or is used in the walls of <i>chimneys</i> or fireplaces. [F20, F21, F55, F61, F80-OH1.1, OH1.2] [F20, F21, F80, F61-OH1.3] Applies where concrete supports or is used in an environmental separator. [F20, F21, F80-OH4] Applies where concrete elements support wood-frame floors. [F20, F21, F80-OS1.1] Applies where concrete supports or is used in <i>chimneys</i> or fireplaces. [F20-OS2.1] [F21, F80-OS2.3] [F20-OS2.3] Applies to elements that support or are part of an environmental separator. [F20, F21, F80-OS3.1] Applies to concrete floors or steps, concrete that supports wood-frame floors or steps, and concrete steps that support <i>guards</i> or handrails. [F20, F21, F80-OS3.4, OS3.7] Applies where concrete supports or is used in <i>chimneys</i> or fireplaces.
e4 (2), (3)	
(4)	[F20-OP2.1, OP2.4] [F21, F80-OP2.3, OP2.4] [F20-OP2.3] Applies to elements that support or are part of an environmental separator. [F20, F21, F80-OH1.1] Applies where concrete supports or is used in the walls of <i>chimneys</i> or fireplaces. [F20, F21, F55, F80, F61-OH1.1, OH1.2] [F20, F21, F80, F61-OH1.3] Applies to elements that support or are part of an environmental separator.

Acceptable Solution	Objectives and Functional Statements
(4) (Cont'd)	[F20, F21, F80-OH4] Applies to elements that support floors. [F20, F80-OS1.1] Applies where concrete supports or is used in <i>chimneys</i> or fireplaces. [F20-OS2.1] [F80-OS2.3] [F20-OS2.3] Applies to elements that support or are part of an environmental separator. [F20, F80-OS3.1] Applies to concrete that supports wood-frame floors or steps. [F20, F80-OS3.4, OS3.7] Applies where concrete supports or is used in <i>chimneys</i> or fireplaces.
9.3.1.2.	Cement
(1)	[F20-OP2.1, OP2.4] [F80-OP2.3, OP2.4] [F20-OP2.3] Applies to elements that support or are part of an environmental separator. [F20, F80-OH1.1] Applies where concrete supports or is used in the walls of <i>chimneys</i> or fireplaces. [F20, F55, F61, F80-OH1.1, OH1.2] [F20, F61, F80-OH1.3] Applies where concrete supports or is used in an environmental separator. [F20, F80-OH4] Applies where concrete elements support wood-frame floors. [F20, F80-OS1.1] Applies where concrete supports or is used in <i>chimneys</i> or fireplaces. [F20-OS2.1] [F80-OS2.3] [F20-OS2.3] Applies to elements that support or are part of an environmental separator. [F20, F80-OS3.1] Applies to concrete floors or steps, concrete that supports wood-frame floors or steps, and concrete steps that support <i>guards</i> or handrails. [F20, F80-OS3.4, OS3.7] Applies where concrete supports or is used in <i>chimneys</i> or fireplaces.
9.3.1.3.	Concrete in Contact with Sulfate Soil
(1)	[F20-OP2.1, OP2.4] [F80-OP2.3, OP2.4] [F20-OP2.3] Applies to elements that support or are part of an environmental separator. [F80-OH1] Applies where concrete supports or is used in the walls of <i>chimneys</i> or fireplaces. [F80-OH1.1, OH1.2, OH1.3] Applies where concrete supports or is used in an environmental separator. [F80-OH4] Applies where concrete elements support wood-frame floors. [F80-OS1.1] Applies where concrete is used in footings for <i>chimneys</i> or fireplaces. [F20-OS2.1] [F80-OS2.3] [F20-OS2.3] Applies to elements that support or are part of an environmental separator. [F80-OS3.1] Applies to concrete floors or steps, concrete that supports wood-frame floors or steps, and concrete steps that support <i>guards</i> or handrails. [F80-OS3.4, OS3.7] Applies where concrete supports or is used in <i>chimneys</i> or fireplaces.
9.3.1.4.	Aggregates
(1)	[F20-OP2.1, OP2.4] [F80-OP2.3, OP2.4] [F20-OP2.3] Applies to elements that support or are part of an environmental separator. [F20, F80-OS1.1] Applies to concrete used in <i>chimneys</i> or fireplaces. [F20-OS2.1] [F80-OS2.3] [F20-OS2.3] Applies to elements that support or are part of an environmental separator. [F20, F80-OS3.1] Applies to floors and elements that support floors. [F20, F80-OS3.4] Applies to concrete used in <i>chimneys</i> or fireplaces. [F20, F55, F61, F80-OH1.1, OH1.2] Applies to elements that support or are part of an environmental separator and to masonry used in <i>chimneys</i> and fireplaces. [F20, F61, F80-OH1.3] Applies to elements that support or are part of an environmental separator and to masonry used in <i>chimneys</i> and fireplaces. [F20, F80-OH4] Applies to floors and elements that support floors.
9.3.1.5.	Water
(1)	[F20-OP2.1, OP2.4] [F80-OP2.3, OP2.4] [F20-OP2.3] Applies to elements that support or are part of an environmental separator. [F20, F80-OS1.1] Applies where concrete supports or is used in <i>chimneys</i> or fireplaces.

Acceptable Solution	Objectives and Functional Statements
(1) (Cont'd)	[F20-OS2.1] [F80-OS2.3] [F20-OS2.3] Applies to elements that support or are part of an environmental separator. [F20, F80-OS3.1] Applies to concrete floors or steps, concrete that supports wood-frame floors or steps, and concrete steps that support <i>guards</i> or handrails. [F20, F80-OS3.4, OS3.7] Applies where concrete supports or is used in chimneys or fireplaces. [F20, F55, F61, F80-OH1.1, OH1.2] Applies to elements that support or are part of an environmental separator and to masonry used in <i>chimneys</i> and fireplaces. [F20, F61, F80-OH1.3] Applies to elements that support or are part of an environmental separator and to masonry used in <i>chimneys</i> and fireplaces. [F20, F80-OH4] Applies where concrete elements support wood-frame floors.
9.3.1.6.	Compressive Strength
(1)	(a) [F20-OP2.1, OP2.4] (a) [F21-OP2.3, OP2.4] (a) [F80-OP2.3] (a) [F20-OP2.3] Applies to elements that support are part of an environmental separator. (a) [F20, F21, F80-OS1.1] Applies where concrete supports or is used in chimneys or fireplaces. (a) [F20-OS2.1] (a) [F21, F80-OP2.3] (a) [F20-OS2.3] Applies to elements that support or are part of an environmental separator. (a) [F20, F80-OS3.1] Applies to elements that support floors or steps. (a) [F20, F80-OS3.4, OS3.7] Applies where concrete supports or is used in <i>chimneys</i> or fireplaces. (a) [F20, F80-OH1.1] Applies where concrete supports or is used in the walls of <i>chimneys</i> or fireplaces. (a) [F20, F55, F61, F80-OH1.1, OH1.2] [F20, F61, F80-OH1.3] Applies where concrete supports or is used in an environmental separator. (a) [F20, F21, F80-OH4] Applies to elements that support floors. (b) [F20-OP2.1, OP2.4] (b) [F21-OP2.3, OP2.4] (b) [F80-OP2.3] (b) [F20-OP2.3] Applies to elements that support or are part of an environmental separator. (b) [F20-OS2.1] (b) [F21, F80-OS2.3] (b) [F20-OS2.3] Applies to elements that support or are part of an environmental separator. (b) [F20, F21, F80-OS3.1] (b) [F20, F21, F55, F61, F80-OH1.1, OH1.2] [F20, F21, F61, F80-OH1.3], (c) [F20-OP2.1] [F20, F21, F80-OP2.3, OP2.4] (c) [F20-OS2.1] [F20, F21, F80-OS2.3] (c) [F20, F21, F80-OS3.1]
(2)	[F80-OS3.1]
9.3.1.7.	Concrete Mixes
(1)	(a) [F20-OP2.1, OP2.4] (a) [F21-OP2.3, OP2.4] (a) [F20, F55, F61-OP2.3] Applies to elements that support or are part of an environmental separator. (a) [F20, F21, F61-OS1.1] Applies where concrete supports or is used in <i>chimneys</i> or fireplaces. (a) [F20-OS2.1] (a) [F21-OS2.3] (a) [F20, F61, F55-OS2.3] Applies to elements that support or are part of an environmental separator. (a) [F20, F21, F61-OS3.1] Applies to concrete floors or steps, concrete that supports wood-frame floors or steps, and concrete steps that support <i>guards</i> or handrails. (a) [F20, F21, F61-OS3.4, OS3.7] Applies where concrete supports or is used in <i>chimneys</i> or fireplaces. (a) [F20, F21, F80-OH1.1] Applies where concrete supports or is used in the walls of <i>chimneys</i> or fireplaces. (a) [F20, F21, F80, F61, F55-OH1.1, OH1.2] [F20, F21, F80, F61-OH1.3] Applies where concrete supports or is used in an environmental separator. (a) [F20, F21, F61-OH4] Applies to elements that support floors.

Acceptable Solution	Objectives and Functional Statements
(1) (Cont'd)	(b) [F20-OP2.1, OP2.4] (b) [F21-OP2.3, OP2.4] (b) [F80-OP2.3] (b) [F20-OP2.3] Applies where concrete is used in an environmental separator. (b) [F20, F21, F55, F61, F80-OH1.1, OH1.2] [F20, F21, F61, F80-OH1.3] (b) [F20-OS2.1] (b) [F21, F80-OS2.3] (b) [F20-OS2.3] Applies where concrete is used in an environmental separator. (b) [F20, F21, F80-OS3.1] (c) [F20, F21, F80-OP2.3, OP2.4] (c) [F20, F21-OS2.1] [F20, F21, F80-OS2.3] (c) [F20, F21, F80-OS3.1]
(2)	[F20-OP2.1, OP2.4] [F21-OP2.3, OP2.4] [F20, F61, F55-OP2.3] Applies where concrete supports or is used in an environmental separator. [F20, F21-OS1.1] Applies where concrete supports or is used in <i>chimneys</i> or fireplaces. [F20-OS2.1] [F21-OS2.3] [F20, F55, F61-OS2.3] Applies to elements that support or are part of an environmental separator. [F20, F80-OS3.1] Applies to concrete floors or steps, concrete that supports wood-frame floors or steps, and concrete steps that support <i>guards</i> or handrails. [F20, F80-OS3.1, OS3.7] Applies where concrete supports or is used in <i>chimneys</i> or fireplaces. [F20, F21, F55, F61-OH1.1] Applies where concrete supports or is used in the walls of <i>chimneys</i> or fireplaces. [F20, F21-OH1.2, OH1.3] Applies where concrete supports or is used in an environmental separator. [F20, F21, F55, F61-OH4] Applies where concrete elements support wood-frame floors.
9.3.1.8.	Admixtures
(1)	[F20-OP2.1, OP2.4] [F21-OP2.3, OP2.4] [F80-OP2.3, OP2.4] [F20-OP2.3] Applies to elements that support or are part of an environmental separator. [F20, F21, F80-OS1.1] Applies where concrete supports or is used in <i>chimneys</i> or fireplaces. [F20-OS2.1] [F21-OS2.3] [F20, F55, F61-OS2.3] Applies to elements that support or are part of an environmental separator. [F20, F80-OS3.1] Applies to concrete floors or steps, concrete that supports wood-frame floors or steps, and concrete steps that support <i>guards</i> or handrails. [F20, F80-OS3.4, OS3.7] Applies where concrete supports or is used in <i>chimneys</i> or fireplaces. [F20, F80-OH1.1] Applies where concrete supports or is used in the walls of <i>chimneys</i> or fireplaces. [F20, F55, F61, F80-OH1.1, OH1.2] [F20, F61, F80-OH1.3] Applies where concrete supports or is used in an environmental separator. [F20, F21, F80-OH4] Applies where concrete elements support wood-frame floors.
9.3.1.9.	Cold Weather Requirements
(1)	[F20-OP2.1, OP2.4] [F21, F80-OP2.3, OP2.4] [F20-OP2.3] Applies to elements that support or are part of an environmental separator. [F20, F21, F80-OS1.1] Applies where concrete supports or is used in <i>chimneys</i> or fireplaces. [F20-OS2.1] [F21-OS2.3] [F20-OS2.3] Applies to elements that support or are part of an environmental separator. [F20, F80-OS3.1] Applies to concrete floors or steps, concrete that supports wood-frame floors or steps, and concrete steps that support <i>guards</i> or handrails. [F20, F80-OS3.4, OS3.7] Applies where concrete supports or is used in <i>chimneys</i> or fireplaces. [F20, F80-OH1.1] Applies where concrete supports or is used in the walls of <i>chimneys</i> or fireplaces. [F20, F55, F61, F80-OH1.1, OH1.2] [F20, F61, F80-OH1.3] Applies where concrete supports or is used in an environmental separator. [F20, F21, F80-OH4] Applies where concrete elements support wood-frame floors.
(2)	[F20-OH1.1] Applies where concrete supports or is used in the walls of <i>chimneys</i> or fireplaces. [F20, F55, F61-OH1.1, OH1.2] [F20, F61-OH1.3] Applies where concrete supports or is used in an environmental separator. [F20, F55, F61-OH4] Applies to elements that support floors.

Acceptable Solution	Objectives and Functional Statements
(2) (Cont'd)	[F20-OP2.1, OP2.4] [F20, F55, F61-OP2.3] [F55, F61-OP2.4] Applies to elements that support or are part of an environmental separator. [F20-OS1.1] Applies to concrete that supports or is used in <i>chimneys</i> or fireplaces. [F20-OS2.1] [F20, F55, F61-OS2.3] Applies to elements that support or are part of an environmental separator. [F20, F55, F61-OS3.1] Applies to floors and elements that support floors. [F20, F55, F61-OS3.4] Applies to concrete that supports or is used in <i>chimneys</i> or fireplaces.
9.3.2.1.	Grade Marking
(1)	
9.3.2.2.	Lumber Grades
(1)	[F20-OP2.1, OP2.4] [F22-OP2.4] [F20, F22-OP2.3] Applies to elements that support or are part of an environmental separator. [F20, F22-OH1.1, OH1.2, OH1.3] Applies to elements that support or are part of an environmental separator. [F20, F22-OH4] Applies to floors and elements that support floors. [F20, F22-OS1.2] Applies to assemblies required to provide fire resistance. [F20-OS2.1] [F20, F22-OS2.3] Applies to elements that support or are part of an environmental separator. [F22-OS3.1] Applies to floors and elements that support floors. [F22-OS3.7] Applies to walls, or elements that support walls, that contain doors or windows required for emergency egress.
9.3.2.3.	Machine Stress Rated Lumber
(1)	
9.3.2.4.	OSB, Waferboard and Plywood Marking
(1)	
9.3.2.5.	Moisture Content
(1)	[F21, F80-OP2.3, OP2.4] [F21, F80-OH1.1, OH1.2, OH1.3] Applies to elements that support or are part of an environmental separator. [F21, F80-OH4] Applies to floors and elements that support floors. [F21, F80-OS1.2] Applies to assemblies required to provide fire resistance. [F21, F80-OS2.3] [F21, F80-OS3.1] Applies to floors and elements that support floors.
9.3.2.6.	Lumber Dimensions
(1)	
9.3.2.7.	Panel Thickness Tolerances
(1)	
9.3.2.8.	Undersized Lumber
(1)	[F20-OP2.1, OP2.4] [F22-OP2.4] [F20, F22-OP2.3] Applies to elements that support or are part of an environmental separator. [F20, F22-OH1.1, OH1.2, OH1.3] Applies to elements that support or are part of an environmental separator. [F20, F22-OH4] Applies to floors and elements that support floors. [F20, F22-OS1.2] Applies to assemblies required to provide fire resistance. [F20-OS2.1] [F20, F22-OS2.3] Applies to elements that support or are part of an environmental separator. [F20, F22-OS3.1] Applies to floors and elements that support floors.
9.3.2.9.	Termite and Decay Protection
(1)	[F80, F82-OP2.3, OP2.4] [F80, F82-OS1.2] Applies where wood elements support or are used in assemblies that are required to provide fire resistance. [F80, F82-OS2.3] [F80, F82-OS3.1] Applies where structural wood elements support or are used in floors.

Acceptable Solution	Objectives and Functional Statements
(1) (Cont'd)	[F55, F61, F80, F82-OH1.1, OH1.2] Applies where structural wood elements support or are used in an environmental separator. [F80, F82-OH4] Applies where structural wood elements support or are used in floors.
(2)	[F80, F82-OP2.3, OP2.4] [F80, F82-OS2.1] Applies where structural wood elements support or are used in assemblies that are required to provide fire resistance. [F80, F82-OS2.3] [F80, F82-OS3.1] Applies where structural wood elements support or are used in floors. [F55, F61, F82, F80-OH1.1, OH1.2] [F61, F80, F82-OH1.3] Applies where structural wood elements support or are used in an environmental separator. [F80, F82-OH4] Applies where structural wood elements support or are used in floors.
(3)	[F80-OP2.3, OP2.4] [F80-OS1.2] Applies where structural wood elements support or are used in assemblies that are required to provide fire resistance. [F80-OS2.3] [F80-OS3.1] Applies where structural wood elements support or are used in floors. [F55, F61, F80, F82-OH1.1, OH1.2] [F61, F80, F82-OH1.3] Applies where structural wood elements support or are used in an environmental separator. [F80-OH4] Applies where structural wood elements support or are used in floors.
(4)	[F55, F61, F80, F82-OH1.1, OH1.2] [F42-OP2.3] [F42-OS2.3]
(5)	[F80-OP2.3, OP2.4, OP2.5] [F80-OS1.2] Applies where cribbing or retaining walls support assemblies that are required to provide fire resistance. [F80-OS2.3, OS2.5] [F80-OS3.1] Applies where cribbing or retaining walls support floors. [F55, F61, F80-OH1.1, OH1.2] [F61, F80-OH1.3] Applies where cribbing or retaining walls support an environmental separator. [F80-OH4] Applies to floors and elements that support floors.
(6)	[F80, F81-OP2.3, OP2.4] [F80, F81-OS1.2] Applies where structural wood elements support or are used in assemblies that are required to provide fire resistance. [F80, F81-OS2.3] [F80, F81-OS3.1] Applies where structural wood elements support or are used in floors. [F55, F61, F80, F81-OH1.1, OH1.2] [F61, F80, F81-OH1.3] Applies where structural wood elements support or are used in an environmental separator. [F80, F81-OH4] Applies where structural wood elements support wood-frame floors.
(7)	[F20, F61-OP2.3, OP2.4] [F80, F81-OS1.2] Applies where structural wood elements support or are used in assemblies that are required to provide fire resistance. [F20, F60-OS2.3] [F20, F61-OS3.1] Applies where structural wood elements support or are used in floors. [F20, F55, F61-OH1.1, OH1.2] [F20, F61-OH1.3] Applies where structural wood elements support or are used in an environmental separator. [F61, F80-OH4] Applies to floors and elements that support floors.
(8)	
9.3.3.1.	Sheet Metal Thickness
(1)	
9.3.3.2.	Galvanized Sheet Steel
(1)	[F80-OP2.3, OP2.4] [F80-OH1.1, OH1.2, OH1.3] Applies where sheet metal is used in an environmental separator. [F80-OH4.1] Applies where sheet metal is used in assemblies that support floors. [F80-OS2.3]

Acceptable Solution	Objectives and Functional Statements
(1) (Cont'd)	[F80-OS3.1] Applies where sheet metal is used in assemblies that support floors.
(2)	[F80-OH1.1, OH1.2, OH1.3]
	[F80-OP2.3]
	[F80-OS2.3]
9.4.1.1. General	
(1)	
(2)	
(3)	
9.4.2.1. Application	
(1)	
9.4.2.2. Specified Design Snow Loads	
(1)	[F20-OP2.1, OP2.3] [F22-OP2.3]
	[F20-OS2.1, OS2.3] [F22-OS2.3]
	[F22-OH1.1, OH1.2, OH1.3]
(2)	[F20-OP2.1]
	[F20-OS2.1]
(3)	
9.4.2.3. Platforms Subject to Snow and Occupancy Loads	
(1)	[F20-OP2.1]
	[F20-OS2.1]
9.4.2.4. Attics and Roof Spaces	
(1)	[F20-OP2.1]
	[F20-OS2.1]
9.4.3.1. Deflections	
(1)	[F22-OH1.1, OH1.2, OH1.3] Applies to elements that support or are part of an environmental separator.
	[F22-OH4]
	[F22-OP2.1, OP2.4]
	[F22-OP2.3] Applies to elements that support or are part of an environmental separator.
	[F22-OS2.3] Applies to elements that support or are part of an environmental separator.
	[F22-OS3.1] Applies to floors and elements that support floors. [F22-OS3.7] Applies to walls, and elements that support walls, that contain doors or windows required for emergency egress.
(2)	
9.4.4.1. Allowable Bearing Pressures	
(1)	[F20-OH1.1, OH1.2, OH1.3] Applies to footings that support an environmental separator.
	[F20-OH4] Applies to footings that support floors and other elements that support floors.
	[F20-OP2.2, OP2.4]
	[F20-OP2.3] Applies to elements that support or are part of an environmental separator.
	[F20-OS2.2]
	[F20-OS2.3] Applies to elements that support or are part of an environmental separator. [F20-OS3.1] Applies to footings that support floors and other elements that support floors. [F20-OS3.7] Applies to footings that support walls that contain doors or windows required for emergency egress.
(2)	
(3)	
9.4.4.2. Foundation Capacity in Weaker Soil and Rock	
(1)	[F20-OH1.1, OH1.2, OH1.3] Applies to elements that support or are part of an environmental separator.
	[F20-OH4] Applies to floors and elements that support floors.
	[F20-OP2.2, OP2.4] [F20-OP2.3] Applies to elements that support or are part of an environmental separator.
	[F20-OS2.2]
	[F20-OS2.3] Applies to elements that support or are part of an environmental separator. [F20-OS3.1] Applies to floors and elements that support floors.
(2)	[F20-OH1.1, OH1.2, OH1.3] Applies to elements that support or are part of an environmental separator.
	[F20-OH4] Applies to floors and elements that support floors.

Acceptable Solution	Objectives and Functional Statements
(2) (Cont'd)	[F20-OP2.2, OP2.4] [F20-OP2.3] Applies to elements that support or are part of an environmental separator. [F20-OS2.2] [F20-OS2.3] Applies to elements that support or are part of an environmental separator. [F20-OS3.1] Applies to floors and elements that support floors.
9.4.4.3.	High Water Table
(1)	[F20-OH1.1, OH1.2, OH1.3] Applies to elements that support or are part of an environmental separator. [F20-OH4] Applies to floors and elements that support floors. [F20-OP2.2, OP2.4] [F20-OP2.3] Applies to elements that support or are part of an environmental separator. [F20-OS2.2] [F20-OS2.3] Applies to elements that support or are part of an environmental separator. [F20-OS3.1] Applies to floors and elements that support floors.
9.4.4.4.	Soil Movement
(1)	[F21-OH1.1, OH1.2, OH1.3] Applies to walls that support or are part of an environmental separator. [F21-OH4] Applies to foundations that support floors and other elements that support floors. [F21-OP2.1, OP2.4] [F21-OP2.3] Applies to elements that support or are part of an environmental separator. [F21-OS2.1] [F21-OS2.3] Applies to elements that support or are part of an environmental separator. [F21-OS3.1] Applies to footings that support floors and other elements that support floors. [F21-OS3.7] Applies to footings that support walls that contain doors or windows required for emergency egress.
9.4.4.5.	Reserved
9.4.4.6.	Walls Supporting Drained Earth
(1)	[F20-OH1.1, OH1.2, OH1.3] [F20-OH4] Applies to floors and elements that support floors. [F20-OP2.1, OP2.3, OP2.4] [F20-OS2.1, OS2.3] [F20-OS3.1] Applies to floors and elements that support floors. [F20-OS3.7] Applies to walls, and elements that support walls, that contain doors or windows required for emergency egress.
(2)	[F20-OH1.1, OH1.2, OH1.3] [F20-OH4] Applies to floors and elements that support floors. [F20-OP2.1, OP2.3, OP2.4] [F20-OS2.1, OS2.3] [F20-OS3.1] Applies to floors and elements that support floors. [F20-OS3.7] Applies to walls, and elements that support walls, that contain doors or windows required for emergency egress.
9.5.1.1.	Application
(1)	
9.5.1.2.	Method of Measurement
(1)	
9.5.1.3.	Floor Areas
(1)	
9.5.1.4.	Combination Rooms
(1)	
(2)	[F10-OS3.7]
(3)	
9.5.1.5.	Lesser Areas and Dimensions
(1)	
9.5.2.1.	General
(1)	
(2)	

Acceptable Solution	Objectives and Functional Statements
9.5.2.2.	Protection on Floor Areas with a Barrier-Free Path of Travel
(1)	
9.5.2.3.	Stud Wall Reinforcement
(1)	[F74-OA2]
9.5.3.1.	Ceiling Heights of Rooms or Spaces
(1)	[F30-OS3.1] [F10-OS3.7]
(2)	
9.5.3.2.	Mezzanines
(1)	[F30-OS3.1] [F10-OS3.7]
9.5.3.3.	Storage Garages
(1)	[F30-OS3.1] [F10-OS3.7]
9.5.4.1.	Areas of Living Rooms and Spaces
(1)	[F10-OS3.7]
(2)	[F10-OS3.7]
9.5.5.1.	Area of Dining Rooms or Spaces
(1)	[F10-OS3.7]
(2)	[F10-OS3.7]
9.5.6.1.	Kitchen Areas
(1)	[F10-OS3.7]
9.5.7.1.	Areas of Bedrooms
(1)	[F10-OS3.7]
9.5.7.2.	Areas of Master Bedrooms
(1)	[F10-OS3.7]
9.5.7.3.	Areas of Combination Bedrooms
(1)	[F10-OS3.7]
9.5.7.4.	Areas of Other Sleeping Rooms
(1)	[F10-OS3.7]
9.5.7.5.	Recreational Camps
(1)	[F10-OS3.7]
9.5.7.6.	Camps for Housing Workers
(1)	[F10-OS3.7]
9.5.8.1.	Combined Living, Dining, Bedroom and Kitchen Spaces
(1)	[F10-OS3.7]
9.5.9.1.	Space to Accommodate Fixtures
(1)	[F70, F71-OH2.3] [F101-OH6]
9.5.9.2.	Doors to Rooms Containing Water Closets
(1)	[F101-OH6] Applies to portion of Code text: "to each room containing a water closet"
9.5.10.1.	Hallway Width
(1)	[F10-OS3.7]
9.5.11.1.	Doorway Opening Sizes
(1)	[F30-OS3.1] [F10-OS3.7]
9.5.11.2.	Doors to Public Water Closet Rooms
(1)	[F30-OS3.1] [F10-OS3.7]
9.5.11.3.	Doors to Bathrooms
(1)	[F74-OA2]
9.6.1.1.	Application
(1)	
9.6.1.2.	Material Standards for Glass
(1)	[F20-OS2.1] [F63-OS2.3]
(2)	[F30-OS3.1] [F10-OS3.7]

Acceptable Solution	Objectives and Functional Statements
(3)	[F30-OS3.1] [F10-OS3.7]
F11.1	9.6.1.3. Structural Sufficiency of Glass
(1)	[F20-OS2.1]
(2)	[F20-OS2.1]
(3)	[F30-OS3.1] [F10-OS3.7]
9.6.1.4.	Types of Glass and Protection of Glass
(1)	[F30-OS3.1] [F10-OS3.7]
(2)	[F30-OS3.1] [F10-OS3.7]
(3)	[F30-OS3.1] [F10-OS3.7]
(4)	[F30-OS3.1] [F10-OS3.7] Applies to portion of Code text: "... except that such <i>partitions</i> shall be suitably marked to indicate their existence and position."
(5)	[F30-OS3.1] [F10-OS3.7]
(6)	[F30-OS3.1]
9.7.1.1.	Application
(1)	
(2)	
(3)	
9.7.2.1.	Entrance Doors
(1)	[F40, F42, F61-OH1.1] [F51, F54-OH1.2] [F42-OH2.5] Applies to portion of Code text: "at each entrance to a <i>dwelling unit</i> " [F131-OR2] Applies to portion of Code text: "at each entrance to a <i>dwelling unit</i> " [F42, F61-OS2.3] Applies to portion of Code text: "at each entrance to a <i>dwelling unit</i> "
(2)	[F35-OS4.2]
9.7.2.2.	Other Requirements for Windows, Doors and Skylights
(1)	
(2)	
(3)	
(4)	
(5)	
(6)	
(7)	
(8)	
(9)	
9.7.2.3.	Minimum Window Areas
(1)	[F102-OH7] [F10-OS3.7]
(2)	
(3)	
(4)	
9.7.3.1.	General Performance Criteria
(1)	[F42, F55, F61, F62, F63-OH1.1] [F81-OH1.1] Applies to windows that provide required non-heating season ventilation. [F54, F55, F61, F62, F63-OH1.2] [F63, F61, F62-OH1.3] [F20, F55, F61-OS2.1, OS2.3] [F42-OH2.5] [F81-OS3.7] [F34-OS4.1]
(2)	F81-OH1.1] Applies to skylights that provide required non-heating season ventilation. [F20, F22-OH1.3] [F20-OS2.1, OS2.3]
(3)	[F42, F55-OH1.1]
	[F42-OH2.5]
	[F81-OS3.7]

Acceptable Solution	Objectives and Functional Statements
(3) (Cont'd)	[F34-OS4.1]
(4)	[F20, F22-OS2.3]
	[F30-OS3.1]
	[F20, F61-OH1.1, OH1.2]
	[F34-OS4.1]
(5)	
9.7.3.2.	Heat Transfer Performance
(1)	[F51, F63-OH1.1, OH1.2]
	[F63-OS2.3]
(2)	
9.7.3.3.	Thermal Characteristics of Windows, Doors and Skylights
(1)	[F63-OH1.1, OH1.2, OH1.3]
	[F63-OS2.3]
(2)	F63-OS2.3]
	F63-OH1.1, OH1.2]
(3)	[F63-OH1.1, OH1.2, OH1.3]
	[F63-OS2.3]
(4)	[F63-OH1.1, OH1.2, OH1.3]
	[F63-OS2.3]
	[F63-OS3.1]
9.7.4.1.	Application
(1)	
9.7.4.2.	General
(1)	[F20, F55, F61, F62, F63-OH1.1]
	[F81-OH1.1] Applies to windows that provide required non-heating season ventilation. [F54, F55, F61, F62, F63-OH1.2] [F63, F20, F61, F62-OH1.3]
	[F20, F21, F61-OS2.3]
	[F10-OS1.5] Applies where windows, doors or skylights serve bedrooms, except bedrooms that have direct access to the exterior through an <i>exit</i> door or bedrooms that are in <i>sprinklered</i> suites.
9.7.4.3.	Performance Requirements
(1)	[[F20, F55, F61-OH1.1]
	[F55-OH1.2] [F20, F61, F62-OH1.3]
(2)	
(3)	
(4)	[F40, F61, F42-OH1.1] [F51, F54-OH1.2]
	[F61, F42-OS2.3]
	[F80-OS3.7]
	[F80-OS4.1]
	[F42-OH2.5]
9.7.5.1.	Application and Compliance
(1)	
(2)	
9.7.5.2.	Resistance to Forced Entry for Doors
(1)	
(2)	[F34-OS4.1]
(3)	[F20-OS4.1]
(4)	[F34-OS4.1]
(5)	[F34-OS4.1]
(6)	[F20-OS4.1]
(7)	[F20-OS4.1]
(8)	[F34-OS4.1]
(9)	[F20-OS4.1]

Acceptable Solution	Objectives and Functional Statements
9.7.5.3.	Resistance to Forced Entry for Windows
(1)	[F34-OS4.1]
9.7.6.1.	Installation of Windows, Doors and Skylights
(1)	[F20, F54, F55, F61, F63-OH1.1, OH1.2, OH1.3] [F20, F61, F63-OS2.3]
(2)	[F54, F55, F61, F63-OH1.1, OH1.2, OH1.3] [F61, F63-OS2.3]
(3)	[F55, F61, F63-OS2.3] [F55, F61, F63-OH1.1, OH1.2]
9.7.6.2.	Sealants, Trim and Flashing
(1)	[F61, F63-OH1.1, OH1.3] [F61, F51, F54, F63-OH1.2] [F61, F63-OS2.3]
(2)	
(3)	
(4)	[F80-OS2.1, OS2.3] [F80-OP2.1, OP2.3] [F80-OH1.1, OH1.2, OH1.3]
9.8.1.1.	General
(1)	
9.8.1.2.	Stairs, Ramps, Landings, Handrails and Guards in Garages
(1)	
9.8.1.3.	Exit Stairs, Ramps and Landings
(1)	
9.8.1.4.	Escalators and Moving Walks
(1)	
r11.2 9.8.2.1.	Stair Width
(1) to (4)	[F30-OS3.1] [F10-OS3.7]
r11.2 9.8.2.2.	Height Over Stairs
(1)	
(2)	[F30-OS3.1] [F10-OS3.7]
(3)	[F30-OS3.1] [F10-OS3.7]
r11.2 9.8.3.1.	Straight and Curved Runs in Stairs
(1)	[F30-OS3.1] [F10-OS3.7]
(2)	[F10-OS3.7]
(3)	[F30-OS3.1] [F10-OS3.7]
(4)	[F30-OS3.1] [F10-OS3.7]
9.8.3.2.	Minimum Number of Risers
(1)	[F30-OS3.1] [F10-OS3.7]
r11.2 9.8.3.3.	Maximum Height of Flights
(1)	[F30-OS3.1]
9.8.4.1.	Dimensions for Risers
(1)	[F30-OS3.1] [F10-OS3.7]
r11.2 9.8.4.2.	Dimensions for Runs and Rectangular Treads
(1), (2)	[F30-OS3.1] [F10-OS3.7]
r11.2 9.8.4.3.	Dimensions for Tapered Treads
(1)	[F30-OS3.1] [F10-OS3.7]
(2)	
(3)	[F30-OS3.1] [F10-OS3.7]
r11.2 9.8.4.4.	Uniformity and Tolerances for Risers, Runs and Treads
(1) to (5)	[F30-OS3.1] [F10-OS3.7]
r11.2 9.8.4.4A.	Uniformity of Runs in Flights with Mixed Treads within a House or Dwelling Unit
(1), (2)	[F30-OS3.1] [F10-OS3.7]

	Acceptable Solution	Objectives and Functional Statements
	9.8.4.5.	Winders
	(1)	[F30-OS3.1] [F10-OS3.7]
	(2)	[F30-OS3.1] [F10-OS3.7]
r11.2	9.8.4.5A.	Spiral Stairs
	(1)	[F30-OS3.1]
	(2)	
	(3)	[F30-OS3.1]
	9.8.4.6.	Leading Edges of Treads
	(1)	[F30-OS3.1] [F10-OS3.7]
	9.8.4.7.	Interior Stairs Extending Through the Roof
	(1)	[F30-OS3.1] [F10-OS3.7]
	9.8.5.1.	Application
	(1)	
	(2)	
r11.2	9.8.5.2.	Ramp Width
	(1), (2)	[F30-OS3.1] [F10-OS3.7]
	9.8.5.3.	Height Over Ramps
	(1)	[F30-OS3.1] [F10-OS3.7]
r11.2	9.8.5.4.	Ramp Slope
	(1)	[F30-OS3.1] [F10-OS3.7]
	9.8.5.5.	Maximum Rise
	(1)	[F30-OS3.1]
	9.8.6.1.	Application
e4	(1) to (3)	
	9.8.6.2.	Required Landings
	(1)	[F30-OS3.1] [F10-OS3.7]
	(2)	
	(3)	
r6	(3.1)	
	(4)	
r11.2	9.8.6.3.	Dimensions of Landings
	(1)	[F30-OS3.1] [F10-OS3.7]
	(2)	[F30-OS3.1] [F10-OS3.7]
	(3)	
	(4)	[F30-OS3.1] [F10-OS3.7]
	(5)	[F30-OS3.1] [F10-OS3.7]
	(6)	[F30-OS3.1] [F10-OS3.7]
	(7)	[F30-OS3.1] [F10-OS3.7]
	9.8.6.4.	Height Over Landings
	(1)	[F30-OS3.1] [F10-OS3.7]
	9.8.7.1.	Required Handrails
	(1)	[F30-OS3.1] [F10-OS3.7]
	(2)	[F30-OS3.1] [F10-OS3.7]
	(3)	
	(4)	
r11.2	(5)	[F30-OS3.1] [F10-OS3.7]
	9.8.7.2.	Continuity of Handrails
	(1)	[F30-OS3.1] [F10-OS3.7]
	(2)	[F30-OS3.1] [F10-OS3.7]
	9.8.7.3.	Termination of Handrails
	(1)	[F30-OS3.1] [F10-OS3.7]
	(2)	[F30-OS3.1] [F10-OS3.7]

	Acceptable Solution	Objectives and Functional Statements
R11.2	9.8.7.4.	Height of Handrails
	(1)	
	(2)	[F30-OS3.1] [F10-OS3.7]
	(3)	
	9.8.7.5.	Ergonomic Design
	(1)	[F30-OS3.1] [F10-OS3.7]
	(2)	[F30-OS3.1] [F10-OS3.7]
	9.8.7.6.	Projections into Stairs and Ramps
	(1)	[F30-OS3.1] [F10-OS3.7]
	9.8.7.7.	Design and Attachment of Handrails
	(1)	[F20-OS2.1] [F20-OS3.1, OS3.7]
	(2)	[F20-OS2.1] [F20-OS3.1, OS3.7]
	9.8.8.1.	Required Guards
R11.2	(1)	[F30-OS3.1] [F10-OS3.7]
	(2)	
	(3)	
	(4)	[F30-OS3.1] [F10-OS3.7]
	(5)	[F30-OS3.1]
	(6)	
	(7)	[F30-OS3.1] [F10-OS3.7]
	(8)	[F30-OS3.1] [F10-OS3.7]
	(9)	[F30-OS3.1]
	9.8.8.2.	Loads on Guards
	(1)	[F20-OS2.1]
	(2)	
	(3)	
	(4)	
	(5)	
	9.8.8.3.	Height of Guards
R11.2	(1)	[F30-OS3.1] [F10-OS3.7]
	(2)	[F30-OS3.1] [F10-OS3.7]
	(3)	[F30-OS3.1] [F10-OS3.7]
	(4)	[F30-OS3.1] [F10-OS3.7]
	(5)	
	(6)	[F30-OS3.1] [F10-OS3.7]
	(7)	
	9.8.8.4.	Guards for Floors and Ramps in Garages
R11.2	(1)	[F10-OS3.1]
	(2)	[F20-OS2.1]
	9.8.8.5.	Openings in Guards
	(1)	[F30-OS3.1]
	(2)	[F30-OS3.1]
	(3)	[F30-OS3.1]
	9.8.8.6.	Guards Designed not to Facilitate Climbing
	(1)	[F30-OS3.1]
	(2)	[F30-OS3.1]
	9.8.8.7.	Glass in Guards
	(1)	[F20-OS2.1] [F20-OS3.1, OS3.7]

Acceptable Solution	Objectives and Functional Statements
9.8.9.1.	Loads on Stairs and Ramps
(1)	[F20-OS2.1] [F22-OH4]
9.8.9.2.	Exterior Concrete Stairs
(1)	[F22-OS3.1, OS3.7]
(2)	
(3)	
9.8.9.3.	Exterior Wood Steps
(1)	[F80-OS2.3] [F80-OS3.1, OS3.7]
9.8.9.4.	Wooden Stair Stringers
(1)	[F20-OS2.1] [F22-OH4]
(2)	[F20-OS2.1] [F22-OH4]
9.8.9.5.	Treads
(1)	[F20-OS2.1] [F22-OH4]
(2)	[F20-OS2.1] [F22-OH4]
9.8.9.6.	Finish for Treads, Landings and Ramps
(1)	[F30, F80-OS3.1] [F10-OS3.7]
(2)	
(3)	[F30-OS3.1] [F10-OS3.7]
(4)	[F73-OA1]
(5)	[F30-OS3.1] [F10-OS3.7]
9.8.10.1.	Design
(1)	[F20-OS2.1] [F22-OS3.1, OS3.7]
9.8.10.2.	Anchorage
(1)	[F20-OH1.1, OH1.2, OH1.3] [F20-OS2.1] [F22-OS3.1, OS3.7]
9.8.10.3.	Prevention of Damage Due to Frost
(1)	[F21-OH1.1, OH1.2, OH1.3] [F21-OS2.1] [F21-OS3.1]
9.9.1.1.	Application
(1)	
9.9.1.2.	Fire Protection
(1)	
9.9.1.3.	Occupant Load
(1)	
9.9.2.1.	Types of Exits
(1)	
(2)	
(3)	[F04-OP1.2, OP1.3] [F06, F12, F81-OP1.2] [F80-OP2.3] [F04-OS1.2, OS1.3] [F05, F10, F12-OS1.5] [F06-OS1.2] [F20, F80-OS2.1] [F80, F81-OS2.3] [F20, F30-OS3.1] [F10, F12-OS3.7]
(4)	

r5
r4

Acceptable Solution	Objectives and Functional Statements
9.9.2.2.	Purpose of Exits
(1)	[F10-OS3.7] Applies to portion of Code text "An <i>exit</i> shall be designed for no purpose other than exiting ..."
9.9.2.3.	Elevators, Slide Escapes and Windows as Means of Egress
(1)	[F10-OS3.7]
(2)	
9.9.2.4.	Principle Entrances
(1)	[F10-OS3.7]
9.9.2.5.	Front Edge of Stair Treads
(1)	[F30-OS1.5] [F30-OS3.1]
9.9.2.6.	Exterior Exit Stairs that Serve a Hotel
(1)	[F30-OS1.5] [F30-OS3.1]
9.9.3.1.	Application
(1)	
9.9.3.2.	Exit Width
(1)	[F10-OS3.7]
9.9.3.3.	Width of Corridors
(1)	[F30-OS3.1] [F10-OS3.7]
9.9.3.4.	Clear Height
(1)	[F30-OS3.1] [F10-OS3.7]
(2)	[F30-OS3.1] [F10-OS3.7]
9.9.4.1.	Application
(1)	
9.9.4.2.	Fire Separation for Exits
(1)	[F03-OP1.2] [F03-OS1.2] [F05-OS1.5]
(2)	[F03-OP1.2] [F03-OS1.2] [F05-OS1.5]
(3)	[F05-OS1.5]
(4)	[F03-OS1.2] [F05-OS1.5]
(5)	
9.9.4.3.	Wired Glass or Glass Block
(1)	
(2)	[F05-OS1.5]
(3)	
9.9.4.4.	Openings Near Unenclosed Exit Stairs and Ramps
(1)	[F05-OS1.5]
9.9.4.5.	Openings in Exterior Walls of Exits
(1)	[F05-OS1.5]
9.9.4.6.	Openings Near Exit Doors
(1)	
(2)	[F05-OS1.5]
9.9.4.7.	Stairways in Group D or E Buildings
(1)	[F05-OS1.5]
9.9.5.1.	Application
(1)	
9.9.5.2.	Occupancies in Corridors
(1)	[F10-OS3.7]

r5

Acceptable Solution	Objectives and Functional Statements
9.9.5.3.	Obstructions in Public Corridors
(1)	[F30-OS3.1]
(2)	
9.9.5.4.	Obstructions in Exits
(1)	[F10-OS3.7]
9.9.5.5.	Obstructions in Means of Egress
(1)	[F10-OS3.7]
(2)	[F10-OS3.7]
(3)	
9.9.5.6.	Mirrors or Draperies
(1)	[F30-OS3.1] [F10-OS3.7]
9.9.5.7.	Fuel-Fired Appliances
(1)	[F10-OS1.5] [F10-OS3.7]
9.9.5.8.	Service Rooms
(1)	[F30-OS3.1] [F10-OS3.7]
9.9.5.9.	Ancillary Rooms
(1)	[F05, F06-OS1.5] [F10-OS3.7]
9.9.6.1.	Obstructions by Doors
(1)	
(2)	[F30-OS3.1] [F10-OS3.7]
(3)	[F30-OS3.1] [F10-OS3.7]
(4)	
9.9.6.2.	Clear Opening Height at Doorways
(1)	[F30-OS3.1] [F10-OS3.7]
(2)	[F30-OS3.1] [F10-OS3.7]
(3)	
9.9.6.3.	Clear Opening Width at Doorways
(1)	
(2)	[F30-OS3.1] [F10-OS3.7]
(3)	[F30-OS3.1] [F10-OS3.7]
(4)	
9.9.6.4.	Door Action
(1)	[F10-OS3.7]
(2)	[F10-OS3.7]
(3) to (5)	
9.9.6.5.	Direction of Door Swing
(1)	[F10-OS3.7]
(2)	
(3)	[F10-OS3.7]
(4)	[F10-OS3.7]
(5)	[F10-OS3.7]
9.9.6.6.	Proximity of Doors to Stairs
(1)	[F30-OS3.1] [F10-OS3.7]
(2)	[F10-OS3.7]
9.9.6.7.	Door Latching, Locking and Opening Mechanisms
(1)	(a) [F10-OS3.7] (b) [F10, F81-OS3.7]
(2)	[F10-OS3.7]
(3)	[F10-OS3.7] [F73-OA1]

Acceptable Solution	Objectives and Functional Statements
(4)	[F10-OS3.7]
9.9.6.8.	Effort Required to Open
(1)	[F10-OS3.7]
9.9.7.1.	Egress from Roof Area, Podiums, Terraces, Platforms and Contained Open Spaces
(1)	[F10-OS3.7]
(2)	[F10-OS3.7]
(3)	
9.9.7.2.	Means of Egress from Suites
(1)	[F10-OS1.5]
(2)	[F10-OS3.7]
9.9.7.3.	Dead End Corridors
(1)	[F10-OS3.7]
(2)	[F10-OS3.7]
(3)	[F31-OS1.2] [F05-OS1.5] [F30-OS3.1] [F10-OS3.7]
9.9.7.4.	Number and Spacing of Egress Doors
(1)	[F10-OS3.7]
(2)	[F10-OS1.5]
9.9.7.5.	Independent Access to Exit
(1)	[F10-OS3.7]
9.9.7.6.	Travel Distance within Rooms and Suites
(1)	
9.9.8.1.	Measurement of Travel Distance
(1)	
(2)	
(3)	
9.9.8.2.	Number of Required Exits
(1)	[F10-OS3.7]
(2)	
(3)	
9.9.8.3.	Contribution of Each Exit
(1)	[F10-OS3.7]
9.9.8.4.	Location of Exits
(1)	[F10-OS1.5]
9.9.8.5.	Exiting through a Lobby
(1)	[F10-OS1.5]
(2)	[F10-OS1.5]
(3)	[F10-OS1.5]
(4)	[F10-OS1.5]
(5)	[F10-OS1.5]
(6)	[F10-OS1.5]
(7)	[F10-OS1.5]
9.9.8.6.	Mezzanine Means of Egress
(1)	[F05-OS1.5]
(2)	
(3)	
(4)	[F05-OS1.5]
9.9.9.1.	Travel Limit to Exits or Egress Doors
(1)	[F10-OS3.7]
(2)	[F10-OS3.7]
(3)	[F10-OS3.7]

Acceptable Solution	Objectives and Functional Statements	
9.9.9.2.	Two Separate Exits	
(1)	[F10-OS3.7]	
9.9.9.3.	Shared Egress Facilities	
(1)	[F10-OS3.7]	
9.9.10.1.	Egress Windows or Doors for Bedrooms	
(1)	[F10-OS3.7]	
(2)	[F10-OS3.7]	
(3)		
(4)		
(5)	[F10-OS3.7]	
(6)	[F10-OS3.7]	
(7)	[F10-OS3.7]	
9.9.11.1.	Application	
(1)		
9.9.11.2.	Visibility of Exits	
(1)	[F10-OS3.7]	
(2)	[F10-OS3.7]	
R11.1	9.9.11.3.	Exit Signs
	(1)	[F10-OS3.7]
	(2)	[F10, F81-OS3.7]
	(3)	[F10, F81-OS3.7]
	(4)	[F10-OS3.7]
	(5)	[F10-OS3.7]
	(6)	[F10-OS3.7]
	(7)	[F10-OS3.7]
	9.9.11.4.	Signs for Stairs and Ramps at Exit Level
	(1)	[F10-OS3.7]
9.9.11.5.	Floor Numbering	
(1)	[F10-OS3.7]	
	[F73-OA1]	
9.9.12.1.	Application	
(1)		
9.9.12.2.	Required Lighting in Egress Facilities	
(1)	[F30-OS3.1] [F10-OS3.7]	
(2)	[F30-OS3.1] [F10-OS3.7]	
9.9.12.3.	Emergency Lighting	
(1)	[F30-OS3.1] [F10-OS3.7]	
(2)	[F30-OS3.1] [F10-OS3.7]	
(3)	[F30-OS3.1] [F10-OS3.7]	
(4)	[F30-OS3.1] [F10-OS3.7]	
(5)	[F30-OS3.1] [F10-OS3.7]	
(6)	[F30-OS3.1] [F10-OS3.7]	
(7)	[F30-OS3.1] [F10-OS3.7]	
9.10.1.1.	Support of Noncombustible Construction	
(1)	[F04-OP1.3]	
	[F04-OS1.3]	
9.10.1.2.	Sloped Roofs	
(1)		
9.10.1.3.	Items Under Part 3 Jurisdiction	
(1)		
(2)		
(3)		

Acceptable Solution	Objectives and Functional Statements
(4)	
(5)	
(6)	
(7)	
(8)	
(9)	
(10)	
9.10.1.4.	Items Under Part 6 Jurisdiction
(1)	
(2)	
9.10.2.1.	Occupancy Classification
(1)	
9.10.2.2.	Reserved
9.10.2.3.	Major Occupancies above Other Major Occupancies
(1)	
9.10.2.4.	Buildings Containing More Than One Major Occupancy
(1)	
9.10.3.1.	Fire-Resistance and Fire-Protection Ratings
(1)	
9.10.3.2.	Flame-Spread Rating
(1)	
(2)	
9.10.3.3.	Fire Exposure
(1)	
(2)	
(3)	
9.10.3.4.	Suspended Membrane Ceiling
(1)	[F03-OP1.3]
	[F04-OS1.3]
9.10.4.1.	Mezzanines not Considered as Storeys
(1)	
(2)	
9.10.4.2.	More Than One Level of Mezzanine
(1)	
9.10.4.3.	Basement Storage Garages
(1)	
9.10.4.4.	Roof-Top Enclosures
(1)	
9.10.5.1.	Permitted Openings in Wall and Ceiling Membranes
(1)	[F03-OP1.2] [F04-OP1.3]
	[F03-OS1.2] [F04-OS1.3]
(2)	[F04-OP1.3]
	[F04-OS1.3]
(3)	[F03-OP1.2]
	[F03-OS1.2]
(4)	[F04-OP1.3]
	[F04-OS1.2, OS1.3]
9.10.6.1.	Combustible Elements in Noncombustible Construction
(1)	
9.10.6.2.	Heavy Timber Construction
(1)	

Acceptable Solution	Objectives and Functional Statements
9.10.7.1.	Protection of Structural Steel Members
(1)	[F03-OP1.2] [F04-OP1.3] [F03-OS1.2] [F04-OS1.3]
9.10.8.1.	Fire-Resistance Ratings for Floors and Roofs
(1)	[F03-OP1.2] [F04-OP1.2, OP1.3] Applies to portion of Code text: "Except as other wise provided in this Subsection, the <i>fire-resistance ratings</i> of floors and roofs shall conform to Table 9.10.8.1." [F03-OS1.2] [F04-OS1.2, OS1.3] Applies to portion of Code text: "Except as otherwise provided in this Subsection, the <i>fire-resistance ratings</i> of floors and roofs shall conform to Table 9.10.8.1."
9.10.8.2.	Fire-Resistance Ratings in Sprinklered Buildings
(1)	(a), (b) [F13-OP1.2] [F02, F82-OP1.3] (a), (b) [F13-OS1.2, OS1.5] [F02, F82-OS1.3]
9.10.8.3.	Fire-Resistance Ratings for Walls, Columns and Arches
(1)	[F04-OP1.2, OP1.3] [F04-OS1.2, OS1.3]
r6 9.10.8.4.	Reserved
9.10.8.5.	Service Rooms
(1)	
9.10.8.6.	Mezzanines
(1)	
9.10.8.7.	Roofs Supporting an Occupancy
(1)	[F03-OP1.2] [F03-OS1.2]
9.10.8.8.	Floors of Exterior Passageways
(1)	[F06-OP1.2] [F04-OP1.3] [F05-OS1.5] [F06-OS1.2, OS1.5]
(2)	
(3)	
9.10.8.9.	Crawl Spaces
(1)	
r6 9.10.8.10.	Non-Application to Houses
(1)	
9.10.8.11.	Part 3 as an Alternative
(1)	
9.10.9.1.	Application
(1)	
9.10.9.2.	Continuous Barrier
(1)	[F03-OP1.2] [F03-OS1.2]
(2)	[F03-OP1.2] [F03-OS1.2]
9.10.9.3.	Openings to be Protected With Closures
(1)	[F03-OP1.2] [F03-OS1.2]
e4 9.10.9.4.	Floor Assemblies
(1)	[F03-OP1.2] [F03-OS1.2]
(2)	
(3)	
(4)	
9.10.9.5.	Interconnected Floor Spaces
(1)	

Acceptable Solution	Objectives and Functional Statements
9.10.9.6.	Penetration of Fire Separations
(1)	[F03-OP1.2]
	[F03-OS1.2]
(2)	[F03-OP1.2]
	[F03-OS1.2]
(3)	[F03-OP1.2] [F04-OP1.3] Applies to portion of Code text: "Except as provided in Sentence (3) to (9) and Article 9.10.9.7., pipes, ducts, electrical boxes, totally enclosed raceways or other similar service equipment that partly or wholly penetrate an assembly required to have a fire-resistance rating shall be <i>noncombustible</i> ..." [F03-OS1.2] [F04-OS1.3] Applies to portion of Code text: "Except as provided in Sentence (3) to (9) and Article 9.10.9.7., pipes, ducts, electrical boxes, totally enclosed raceways or other similar service equipment that partly or wholly penetrate an assembly required to have a fire-resistance rating shall be <i>noncombustible</i> ..."
(4)	
(5)	
(6)	
(7)	
(8)	
(9)	
(10)	
(11)	
(12)	
(13)	
9.10.9.7.	Combustible Piping
(1)	[F03-OP1.2] [F04-OP1.3]
	[F03-OS1.2] [F04-OS1.3]
(2)	
(3)	
(4)	
(5)	
(6)	
9.10.9.8.	Collapse of Combustible Construction
(1)	[F03-OP1.2]
	[F03-OS1.2]
9.10.9.9.	Reduction in Thickness of Fire Separation by Beams and Joists
(1)	[F03-OP1.2]
	[F03-OS1.2]
9.10.9.10.	Concealed Spaces above Fire Separations
(1)	[F03-OP1.2]
	[F03-OS1.2]
(2)	[F03-OP1.2]
	[F03-OS1.2]
9.10.9.11.	Separation of Residential Occupancies
(1)	[F03-OP1.2]
	[F03-OS1.2]
(2)	[F03-OP1.2]
	[F03-OS1.2]
(3)	[F03-OP1.2]
	[F03-OS1.2]
(4)	
9.10.9.12.	Residential Suites, Live/Work Units and Industrial Buildings
(1)	[F02-OS1.2]
(2)	[F02, F03-OS1.2]

Acceptable Solution	Objectives and Functional Statements
9.10.9.13.	Separation of Suites
(1)	[F03-OP1.2] [F03-OS1.2]
(2)	[F02-OP1.2] [F02-OS1.2]
9.10.9.14.	Separation of Residential Suites
(1)	[F03-OP1.2] [F03-OS1.2]
(2)	
(3)	[F03-OS1.2]
(4)	
(5)	
9.10.9.15.	Separation of Public Corridors
(1)	[F03, F06-OP1.2] [F03, F05-OS1.5] [F06-OS1.2, OS1.5]
(2)	[F03-OS1.2] [F06, F05-OS1.5] [F03, F06-OP1.2]
(3)	[F03-OS1.2] [F05, F06-OS1.5] [F03, F06-OP1.2]
9.10.9.16.	Separation of Storage Garages
(1), (2)	[F03-OP1.2] [F03-OS1.2]
(3)	
(4)	[F01-OS1.1] [F44-OS3.4]
(5)	[F01-OS1.1] [F44-OS3.4]
9.10.9.17.	Separation of Repair Garages
(1)	[F03-OP1.2] [F03-OS1.2]
(2)	
(3)	[F03-OP1.2] [F03-OS1.2]
(4)	[F44-OH1.1] [F44-OS1.1] [F44-OS3.4]
(5)	[F44-OH1.1] [F44-OS1.1] [F44-OS3.4]
9.10.9.18.	Exhaust Ducts Serving More Than One Fire Compartment
(1)	[F03-OS1.2]
(2)	[F03-OS1.2]
9.10.9.19.	Central Vacuum Systems
(1)	[F03-OS1.2]
9.10.10.1.	Application
(1)	
9.10.10.2.	Service Room Floors
(1)	
9.10.10.3.	Separation of Service Rooms
(1)	[F03-OP1.2] [F03, F81-OP1.4] [F03-OS1.2] [F03, F81-OS1.4]
(2)	

Acceptable Solution	Objectives and Functional Statements
9.10.10.4.	Appliances and Equipment to be Located in a Service Room
(1)	[F03-OP1.2] [F03, F81-OP1.4] [F03-OS1.2] [F03, F81-OS1.4]
(2)	
(3)	
9.10.10.5.	Incinerators
(1)	[F03-OP1.2] [F03, F81-OP1.4] [F03-OS1.2] [F03, F81-OS1.4]
(2)	[F01-OS1.1]
(3)	[F01-OP1.1] [F20-OP2.1] [F80-OP2.3] [F01-OS1.1] [F20-OS2.1] [F80-OS2.3] [F40, F61-OH1.1, OH1.3]
(4)	[F01, F02-OS1.2]
9.10.10.6.	Storage Rooms
(1)	[F03-OP1.2] [F03-OS1.2]
9.10.10.7.	Emergency Power Installations
(1)	[F03-OS1.2, OS1.4] [F06-OS1.2, OS1.5] [F03-OP1.2, OP1.4] [F06-OP1.2]
9.10.11.1.	Required Firewalls
(1)	[F03-OP1.2] [F03-OP3.1] [F03-OS1.2]
9.10.11.2.	Firewalls Not Required
(1)	
(2)	[F03-OP3.1] [F03-OS1.2]
(3)	[F03-OP3.1] [F03-OS1.2]
9.10.11.3.	Construction of Firewalls
(1)	
9.10.11.4.	Firewalls in Detached Garages
(1)	[F03-OP1.2] [F03-OS1.2]
9.10.12.1.	Termination of Floors or Mezzanines
(1)	[F03-OP1.2, OP1.4] [F03-OS1.5]
(2)	
9.10.12.2	Location of Skylights
(1)	[F03-OP1.2] [F03-OS1.2]
9.10.12.3.	Exterior Walls Meeting at an Angle
(1)	[F03-OP1.2] [F03-OS1.2]
(2)	[F03-OP1.2] [F03-OS1.2]
9.10.12.4.	Protection of Soffits
(1)	
(2)	[F03-OP1.2] [F03-OS1.2]

Acceptable Solution	Objectives and Functional Statements
(3)	[F03-OP1.2] [F03-OS1.2]
(4)	
(5)	
9.10.13.1.	Closures
(1)	[F03-OP1.2] [F03-OS1.2]
9.10.13.2.	Solid Core Wood Door as a Closure
(1)	
(2)	[F03-OP1.2] [F03-OS1.2]
9.10.13.3.	Unrated Wood Door Frames
(1)	
9.10.13.4.	Doors as a Means of Egress
(1)	
9.10.13.5.	Wired Glass as a Closure
(1)	
(2)	[F03-OP1.2] [F03-OS1.2]
(3)	[F03-OP1.2] [F03-OS1.2]
9.10.13.6.	Steel Door Frames
(1)	[F03-OP1.2] [F03-OS1.2]
9.10.13.7.	Glass Block as a Closure
(1)	
9.10.13.8.	Maximum Size of Opening
(1)	[F03-OP1.2] [F03-OS1.2]
(2)	[F03-OP1.2] [F03-OS1.2]
9.10.13.9.	Door Latch
(1)	[F03-OP1.2] [F03-OS1.2]
9.10.13.10.	Self-Closing Device
(1)	[F03-OP1.2] [F03-OS1.2]
(2)	
9.10.13.11.	Hold-Open Devices
(1)	
9.10.13.12.	Service Room Doors
(1)	[F10-OS1.5] Applies to portion of Code text: "... but shall swing outward from such rooms in all other cases." [F30-OS3.1] Applies to portion of Code text: "Swing-type doors shall open into <i>service rooms</i> containing fuel-fired equipment where such doors lead to <i>public corridors</i> or rooms used for assembly ..."
9.10.13.13.	Fire Dampers
(1)	[F03-OP1.2] [F03-OS1.2]
(2)	
(3)	
(4)	
(5)	

r6

Acceptable Solution	Objectives and Functional Statements
9.10.13.14.	Fire Stop Flaps
(1)	[F03-OP1.3]
	[F03-OS1.3]
9.10.13.15.	Doors Between Garages and Houses or Dwelling Units
(1)	[F01-OS1.1]
	[F44-OS3.4]
(2)	[F01-OS1.1]
	[F44-OS3.4]
9.10.13.16.	Door Stops
(1)	[F81-OP1.4]
	[F81-OS1.4]
9.10.14.1.	Application
(1)	
9.10.14.2.	Area and Location of Exposing Building Face
(1)	
(2)	
(3)	
(4)	
(5)	
9.10.14.3.	Inadequate Fire Fighting Facilities
(1)	[F03-OP3.1]
9.10.14.4.	Openings in Exposing Building Face
(1)	[F03-OP3.1]
(2)	[F03-OP3.1]
(3)	[F03-OP3.1]
(4)	[F03-OP3.1]
(5)	
(6)	
(7)	
9.10.14.5.	Construction of Exposing Building Face and Walls above Exposing Building Face
(1)	[F02, F03-OP3.1]
(2)	[F02, F03-OP3.1]
(3)	[F03-OP3.1]
(4)	
(5)	[F03-OP3.1]
(6)	
(7)	
9.10.14.6.	Minor Openings in Exposing Building Face
(1)	
9.10.15.1.	Application
(1)	
9.10.15.2.	Area and Location of Exposing Building Face
(1)	
(2)	
(3)	
(4)	
(5)	
9.10.15.3.	Inadequate Firefighting Facilities
(1)	[F03-OP3.1]
9.10.15.4.	Glazed Openings in Exposing Building Face
(1)	[F03-OP3.1]
(2)	

Acceptable Solution	Objectives and Functional Statements
(3)	
(4)	[F03-OP3.1]
(5)	
9.10.15.5.	Construction of Exposing Building Face of Houses
(1)	[F02, F03-OP3.1]
(2)	[F02, F03-OP3.1]
(3)	[F02, F03-OP3.1]
(4)	
(5)	[F03-OP3.1]
(6)	
9.10.16.1.	Required Fire Blocks in Concealed Spaces
(1) to (4)	[F03-OP1.2]
	[F03-OS1.2]
(5)	[F02, F03-OP1.2]
	[F02, F03-OS1.2]
(6)	[F02, F03-OP1.2]
	[F02, F03-OS1.2]
9.10.16.2.	Required Fire Blocks in Wall Assemblies
(1)	[F03-OP1.2]
	[F03-OS1.2]
(2)	
9.10.16.3.	Fire Block Materials
(1)	[F03-OP1.2]
	[F03-OS1.2]
(2)	[F03-OP1.2]
	[F03-OS1.2]
(3)	[F04-OP1.2]
	[F04-OS1.2]
9.10.16.4.	Penetration of Fire Blocks
(1)	[F03-OP1.2]
	[F03-OS1.2]
9.10.17.1.	Flame-Spread Rating of Interior Surfaces
(1)	[F02-OS1.2]
(2)	
(3)	
9.10.17.2.	Ceilings in Exits or Public Corridors
(1)	[F05-OS1.5]
9.10.17.3.	Walls in Exits
(1)	[F05-OS1.5]
(2)	[F05-OS1.5]
9.10.17.4.	Exterior Exit Passageways
(1)	[F05-OS1.5]
9.10.17.5.	Walls in Public Corridors
(1)	[F05-OS1.5]
9.10.17.6.	Calculation of Wall and Ceiling Areas
(1)	
9.10.17.7.	Corridors Containing an Occupancy
(1)	
9.10.17.8.	Light Diffusers and Lenses
(1)	

Acceptable Solution	Objectives and Functional Statements
9.10.17.9.	Combustible Skylights
(1)	[F02, F05-OS1.5]
r11.1	9.10.17.10. Protection of Foamed Plastics
(1)	[F01, F02, F05-OS1.5]
(2)	[F02-OS1.2] [F05-OS1.5]
	[F02-OP1.2]
(3)	
(4)	[F01, F02-OS1.2]
9.10.17.11.	Walls and Ceilings in Bathrooms
(1)	
9.10.17.12.	Coverings or Linings of Ducts
(1)	
9.10.18.1.	Access Provided through a Firewall
(1)	[F11-OS1.5]
9.10.18.2.	Fire Alarm System Required
(1)	[F11-OS1.5]
(2)	
e2.1	9.10.18.3. Design and Installation Requirements
(1), (2)	
9.10.18.4.	Rooms and Spaces Requiring Heat Detectors or Smoke Detectors
(1)	[F11-OS1.5]
(2)	[F11-OS1.5]
(3)	[F02-OS1.2] Applies to <i>sprinklered buildings</i> .
	[F11-OS1.5] Applies to the supervision of the system and flow alarm.
(4)	[F11-OS1.5]
9.10.18.5.	Smoke Detectors in Recirculating Air Handling Systems
(1)	[F03-OS1.2]
9.10.18.6.	Portions of Buildings Considered as Separate Buildings
(1)	[F03-OS1.2]
(2)	[F11-OS1.2]
9.10.18.7.	Central Vacuum Systems
(1)	[F03-OS1.2]
9.10.18.8.	Open-Air Storage Garages
(1)	
9.10.18.9.	Fire Alarm System in a Hotel
(1)	[F11-OS1.5]
r11.1	9.10.18.10. Testing of Integrated Fire Protection and Life Safety Systems
(1)	[F02, F81, F82-OS1.2, OS1.5]
	[F02, F81, F82-OP1.2]
(2)	
9.10.19.1.	Required Smoke Alarms
r5	(1) [F11, F81-OS1.5]
r5	(2) [F11, F81-OS1.5]
r5	[F74-OA2]
r5	(3)
r5	(4) [F11, F81-OS1.5]
r5	[F74-OA2]
r5	(5) [F11, F81-OS1.5]
r5	[F74-OA2]
9.10.19.2.	Sound Patterns of Smoke Alarms
(1)	[F11-OS1.5]

	Acceptable Solution	Objectives and Functional Statements
	9.10.19.3.	Location of Smoke Alarms
	(1)	[F11-OS1.5]
r6	(2)	[F11-OS1.5]
r6	(3)	[F11, F81-OS1.5]
r6	(4)	[F11-OS1.5]
r6	(5)	
r6	(6)	[F11, F81-OS1.5] [F74-OA2]
r6	(7)	[F11-OS1.5]
	9.10.19.4.	Power Supply
	(1)	[F81-OS1.5]
	(2)	
	(3)	[F81-OS1.5]
	(4)	
	9.10.19.5.	Interconnection of Smoke Alarms
	(1)	[F11-OS1.5]
	9.10.19.6.	Silencing of Smoke Alarms
	(1)	[F11, F81-OS1.5]
	(2)	
	9.10.19.7.	Instructions for Maintenance and Care
	(1)	[F82-OS1.5]
r11.1	9.10.19.8.	Residential Fire Warning Systems
	(1)	[F81, F11-OS1.5]
	9.10.20.1.	Windows or Access Panels Required
e3	(1), (2)	[F12-OP1.2] [F12-OS1.2, OS1.5]
	(3)	
	9.10.20.2.	Access to Basements
	(1)	[F12-OP1.2] [F12-OS1.2, OS1.5]
	(2)	[F12-OP1.2] Applies to portion of Code text: "Access required in Sentence (1) ... provides an opening not less than 1 100 mm high and 550 mm wide, the sill of which shall not be more than 900 mm above the floor." [F12-OS1.2, OS1.5] Applies to portion of Code text: "Access required in Sentence (1) ... provides an opening not less than 1 100 mm high and 550 mm wide, the sill of which shall not be more than 900 mm above the floor."
	(3)	
	9.10.20.3.	Fire Department Access to Buildings
e3	(1), (2)	[F12-OP1.2] [F12-OS1.2, OS1.5]
e2	9.10.20.4.	Portable Fire Extinguishers
	(1)	[F02, F12, F81-OP1.2] [F81, F02, F12-OS1.2]
	9.10.20.5.	Freeze Protection for Fire Protection Systems
	(1)	[F02, F81-OP1.2] [F02, F81-OS1.2]
	9.10.21.1	Requirements for Construction Camps
	(1)	
	9.10.21.2.	Separation of Sleeping Rooms
	(1)	[F03-OP1.2] [F03-OS1.2]
	9.10.21.3.	Floor Assemblies Between the First and Second Storey
	(1)	[F03-OP1.2] [F03-OS1.2, OS1.5]

Acceptable Solution	Objectives and Functional Statements
9.10.21.4.	Walkways Connecting Buildings
(1)	[F03-OP1.2]
	[F03-OP3.1]
	[F03, F06-OS1.2, OS1.5]
9.10.21.5.	Spatial Separations
(1)	[F03-OP3.1]
9.10.21.6.	Flame-Spread Ratings
(1)	[F05-OS1.2, OS1.5]
(2)	
9.10.21.7.	Smoke Detectors
(1)	[F11-OS1.5]
9.10.21.8.	Portable Fire Extinguishers
(1)	[F02, F12, F81-OP1.2]
	[F02, F12, F81-OS1.2]
9.10.21.9.	Hose Stations
(1)	[F02, F12, F81-OP1.2]
	[F02, F12, F81-OS1.2]
(2)	[F12-OP1.2]
	[F12-OS1.2]
(3)	[F12-OP1.2]
	[F12-OS1.2]
9.10.22.1.	Installation of Ranges
(1)	
(2)	
9.10.22.2.	Vertical Clearances above Cooktops
(1)	
(2)	[F01-OS1.1, OS1.2]
9.10.22.3.	Protection Around Cooktops
(1)	[F01-OS1.1, OS1.2]
(2)	
(3)	[F01-OS1.1, OS1.2]
F11.1 9.11.1.1.	Required Protection
(1)	[F56-OH3.1]
(2)	[F56-OH3.1]
F11.1 9.11.1.2.	Determination of Sound Transmission Ratings
(1)	[F56-OH3.1]
(2)	[F56-OH3.1]
F11.1 9.11.1.3.	Compliance with Required Ratings
(1)	
(2)	
F11.1 9.11.1.4.	Adjoining Construction
(1)	
(2)	[F56-OH3.1]
(3)	[F56-OH3.1]
(4)	[F56-OH3.1]
9.12.1.1.	Removal of Topsoil and Organic Matter
(1)	[F20, F40, F41-OH1.1]
(2)	[F81-OP2.3, OP2.4]
	[F81-OH1.1, OH1.2, OH1.3] Applies to elements that support or are part of an environmental separator.
	[F81-OS1.2] Applies to assemblies required to provide fire resistance.
	[F81-OS2.3]
	[F81-OS3.1] Applies to floors and elements that support floors.

Acceptable Solution	Objectives and Functional Statements
(3)	[F20-OP2.2] [F20, F21-OP2.3, OP2.4] [F20-OS2.2, OS2.3] [F21-OS2.3] [F20, F21-OS3.1] Applies to floors and elements that support floors. [F20, F21, F40, F41-OH1.1] [F20, F21-OH1.2, OH1.3] Applies to elements that support or are part of an environmental separator. [F20, F21-OH4] Applies to floors and elements that support floors.
9.12.1.2.	Standing Water
(1)	[F60-OP2.2, OP2.3, OP2.4] [F60-OS2.2, OS2.3] [F60-OS3.1] Applies to floors and elements that support floors. [F60-OH1.1, OH1.2, OH1.3] Applies to elements that support or are part of an environmental separator. [F60-OH4] Applies to floors and elements that support floors.
9.12.1.3.	Protection from Freezing
(1)	[F21-OP2.3, OP2.4] [F21-OS2.3] [F21-OS3.1] Applies to floors and elements that support floors. [F21-OH1.1, OH1.2, OH1.3] Applies to elements that support or are part of an environmental separator. [F21-OH4] Applies to floors and elements that support floors.
9.12.1.4.	Precautions During Excavation
(1)	[F20-OP2.3] [F20, F21, F22, F62, F80-OP4.1] [F20, F22, F80-OS2.6]
(2)	[F20-OP2.3] [F20, F21, F80-OP4.1] [F20, F80-OS2.6]
9.12.2.1.	Excavation to Undisturbed Soil
(1)	[F20-OP2.2, OP2.3, OP2.4] [F20-OS2.2, OS2.3] [F20-OS3.1] Applies to floors and elements that support floors. [F20-OH1.1, OH1.2, OH1.3] Applies to elements that support or are part of an environmental separator. [F20-OH4] Applies to floors and elements that support floors.
9.12.2.2.	Minimum Depth of Foundations
(1)	[F21-OP2.3, OP2.4] [F21-OS2.3] [F21-OS3.1] Applies to floors, elements that support floors, and concrete steps with more than 2 risers. [F21-OH1.1, OH1.2, OH1.3] Applies to elements that support or are part of an environmental separator. [F21-OH4] Applies to floors and elements that support floors.
(2)	
(3)	
(4)	
(5)	
(6)	
(7)	
9.12.3.1.	Placement of Backfill
(1)	[F81-OH1.1, OH1.2, OH1.3] Applies to elements that support or are part of an environmental separator. [F22-OH4] Applies to floors and elements that support floors. [F81-OP2.1] [F22-OP2.4] [F81-OP2.3] Applies to elements that support or are part of an environmental separator. [F81-OS2.1] [F81-OS2.3] Applies to elements that support or are part of an environmental separator. [F22-OS3.1] Applies to floors and elements that support floors. [F22-OS3.7] Applies to walls, and elements that support walls, that contain doors or windows required for emergency egress.

Acceptable Solution	Objectives and Functional Statements
9.12.3.2.	Grading of Backfill
(1)	[F60, F61-OH1.1, OH1.2, OH1.3] [F60, F61-OP2.3] [F60, F61-OS2.3]
9.12.3.3.	Deleterious Debris and Boulders
(1)	[F81-OH1.1, OH1.2, OH1.3] [F81-OP2.3] [F81-OS2.3] [F81-OS3.1] Applies to floors and elements that support floors.
(2)	[F20-OH1.1, OH1.2, OH1.3] [F20-OP2.1, OP2.3] [F20-OS2.1, OS2.3] [F20-OS3.1] Applies to floors and elements that support floors.
(3)	[F20-OH1.1, OH1.2, OH1.3] [F20-OP2.1, OP2.3] [F20-OS2.1, OS2.3] [F20-OS3.1] Applies to floors and elements that support floors.
9.12.3.4.	Lateral Support of Foundation Wall
(1)	[F20, F22-OP2.1] [F20, F22-OS2.1]
9.12.4.1.	Compacting or Filling With Concrete
(1)	[F21-OH1.1, OH1.2, OH1.3] [F21-OH2.1] Applies to sewer-line locations beneath footings. [F21-OP2.2] [F21-OP2.3] Applies to elements that support or are part of an environmental separator. [F21-OS2.1] [F21-OS2.3] Applies to elements that support or are part of an environmental separator. [F21-OS3.1] Applies to floors and elements that support floors.
9.13.1.1.	Scope and Application
(1)	
(2)	
(3)	
(4)	
9.13.2.1.	Dampproofing
(1)	[F61-OH1.1, OH1.2, OH1.3] [F61-OS2.3]
(2)	[F61-OH1.1, OH1.2, OH1.3] [F61-OS2.3]
(3)	
(4)	
9.13.2.2.	Dampproofing Materials
(1)	[F61-OS2.3] [F61-OH1.1, OH1.2, OH1.3]
(2)	[F61-OS2.3] [F61-OH1.1, OH1.2, OH1.3]
9.13.2.3.	Preparation of Surface
(1)	[F61-OS2.3] [F61-OH1.1, OH1.2, OH1.3]
(2)	[F61-OS2.3] [F61-OH1.1, OH1.2, OH1.3]
(3)	[F61-OS2.3] [F61-OH1.1, OH1.2, OH1.3]

Acceptable Solution	Objectives and Functional Statements
(4)	[F61-OS2.3]
	[F61-OH1.1, OH1.2, OH1.3]
(5)	[F61-OS2.3]
	[F61-OH1.1, OH1.2, OH1.3]
(6)	[F61-OS2.3]
	[F61-OH1.1, OH1.2, OH1.3]
R11.1	9.13.2.4. Application of Dampproofing Material
(1)	[F61-OS2.3]
	[F61-OH1.1, OH1.2, OH1.3]
(2)	[F61-OS2.3]
	[F61-OH1.1, OH1.2, OH1.3]
(3)	[F61-OS2.3]
	[F61-OH1.1, OH1.2, OH1.3]
R11.1	9.13.2.5. Moisture Protection for Interior Finishes
(1) to (3)	[F61-OS2.3]
	[F61-OH1.1, OH1.2]
R11.1	9.13.2.6. Dampproofing of Floors-on-Ground
(1)	[F61-OS2.3]
	[F61-OH1.1, OH1.2, OH1.3]
(2)	[F61-OS2.3]
	[F61-OH1.1, OH1.2, OH1.3]
R11.1	9.13.2.7. Dampproofing of Preserved Wood Foundation Walls
(1)	[F61-OS2.3]
	[F61-OH1.1, OH1.2, OH1.3]
R11.1	9.13.3.1. Required Waterproofing
(1)	[F61-OS2.3]
	[F61-OH1.1, OH1.2, OH1.3]
(2)	[F61-OS2.3]
	[F61-OH1.1, OH1.2, OH1.3]
R11.1	9.13.3.2. Waterproofing Materials
(1)	[F61-OS2.3]
	[F61-OH1.1, OH1.2, OH1.3]
(2)	[F61-OS2.3]
	[F61-OH1.1, OH1.2, OH1.3]
R11.1	9.13.3.3. Preparation of Surfaces
(1) to (5)	[F61-OS2.3]
	[F61-OH1.1, OH1.2, OH1.3]
R11.1	9.13.3.4. Application of Waterproofing Membranes
(1) to (4)	[F61-OS2.3]
	[F61-OH1.1, OH1.2, OH1.3]
R11.1	9.13.3.5. Floor Waterproofing System
(1)	[F61-OS2.3]
	[F61-OH1.1, OH1.2, OH1.3]
R11.1	9.13.4.1. Soil Gas Control
(1)	[F40-OH1.1]
R11.1	9.13.4.2. Required Soil Gas Control
(1)	[F40-OH1.1]
(2)	
(3)	[F40-OH1.1]
(4)	[F40-OH1.1]
R11.1	9.13.4.3. Material Standards
(1)	[F40-OH1.1]

Acceptable Solution	Objectives and Functional Statements
9.14.1.1.	Application
(1)	
9.14.1.2.	Crawl Spaces
(1)	
9.14.1.3.	Floors-on-Ground
(1)	
9.14.2.1.	Foundation Wall Drainage
(1)	[F60-OH1.1, OH1.2, OH1.3]
(1)	[F60-OP2.1, OP2.2, OP2.3]
(1)	[F60-OS2.1, OS2.2, OS2.3]
(2)	[F60-OH1.1, OH1.2, OH1.3]
(3)	(a) [F60-OH1.1, OH1.2, OH1.3] Applies where <i>foundations</i> serve as or support an environmental separator.
(3)	(a) [F60-OS2.1]
(3)	(a) [F60-OS2.3] Applies where <i>foundations</i> serve as or support an environmental separator.
(3)	(b) [F21-OH1.1, OH1.2, OH1.3] Applies where <i>foundations</i> serve as or support an environmental separator.
(3)	(b) [F21-OH4.1] Applies where <i>foundations</i> support floors or elements supporting floors.
(3)	(b) [F21-OP2.1]
(3)	(b) [F21-OP2.3] Applies where <i>foundations</i> serve as or support an environmental separator.
(3)	(b) [F21-OP2.4] Applies where <i>foundations</i> support walls or floors.
(3)	(b) [F21-OS2.1]
(3)	(b) [F21-OS2.3] Applies where <i>foundations</i> serve as or support an environmental separator.
(3)	(b) [F21-OS3.1] Applies where <i>foundations</i> support floors or elements supporting floors.
(3)	(b) [F21-OS3.7] Applies where <i>foundations</i> support walls that contain windows or doors required for emergency egress.
(4)	[F60-OH1.1, OH1.2, OH1.3]
(5)	
(6)	
9.14.3.1.	Material Standards
(1)	[F60-OH1.1, OH1.2, OH1.3]
(1)	[F60-OP2.1, OP2.3]
(1)	[F60-OS2.1, OS2.3]
9.14.3.2.	Minimum Size
(1)	[F60-OH1.1, OH1.2, OH1.3]
(1)	[F60-OP2.1, OP2.2, OP2.3]
(1)	[F60-OS2.1, OS2.2, OS2.3]
9.14.3.3.	Installation
(1)	[F60-OH1.1, OH1.2, OH1.3]
(1)	[F60-OP2.1, OP2.2, OP2.3]
(1)	[F60-OS2.1, OS2.2, OS2.3]
(2)	[F60-OH1.1, OH1.2, OH1.3]
(2)	[F60-OP2.1, OP2.2, OP2.3]
(2)	[F60-OS2.1, OS2.2, OS2.3]
(3)	[F60-OH1.1, OH1.2, OH1.3]
(3)	[F60-OP2.1, OP2.2, OP2.3]
(3)	[F60-OS2.1, OS2.2, OS2.3]
(4)	[F60-OH1.1, OH1.2, OH1.3]
(4)	[F60-OP2.1, OP2.2, OP2.3]
(4)	[F60-OS2.1, OS2.2, OS2.3]
9.14.4.1.	Type of Granular Material
(1)	(a) [F60-OH1.1, OH1.2, OH1.3]
(1)	(a) [F60-OP2.3] [F21-OP2.6]
(1)	(a) [F21-OS2.2] [F60-OS2.3]
(1)	(b) [F21-OH1.1, OH1.2, OH1.3] Applies to elements that support or are part of an environmental separator.

Acceptable Solution	Objectives and Functional Statements
(1) (Cont'd)	(b) [F21-OH4] Applies to floors and elements that support floors.
	(b) [F21-OP2.1, OP2.4]
	(b) [F21-OP2.3] Applies to elements that support or are part of an environmental separator.
	(b) [F21-OS2.1]
	(b) [F21-OS2.3] Applies to elements that support or are part of an environmental separator
	(b) [F21-OS3.1] Applies to floors and elements that support floors.
9.14.4.2.	Installation
(1)	[F60-OH1.1, OH1.2, OH1.3]
	[F60-OP2.1, OP2.2, OP2.3]
	[F60-OS2.1, OS2.2, OS2.3]
9.14.4.3.	Grading
(1)	[F60-OH1.1, OH1.2, OH1.3]
	[F60-OP2.1, OP2.2, OP2.3]
	[F60-OS2.1, OS2.2, OS2.3]
9.14.4.4.	Wet Site Conditions
(1)	[F60-OH1.1, OH1.2, OH1.3]
	[F60-OP2.1, OP2.2, OP2.3]
	[F60-OS2.1, OS2.2, OS2.3]
9.14.5.1.	Drainage Disposal
(1)	[F60-OH1.1, OH1.2, OH1.3]
	[F60-OP2.1, OP2.2, OP2.3]
	[F60-OS2.1, OS2.2, OS2.3]
9.14.5.2.	Sump Pits
(1)	[F60-OH1.1, OH1.2, OH1.3]
	[F60-OP2.1, OP2.2, OP2.3]
	[F60-OS2.1, OS2.2, OS2.3]
(2)	[F30-OS3.1]
	[F40-OH1.1]
9.14.5.3.	Dry Wells
(1)	[F60-OH1.1, OH1.2, OH1.3]
	[F60-OP2.1, OP2.2, OP2.3]
	[F60-OS2.1, OS2.2, OS2.3]
(2)	[F60-OH1.1, OH1.2, OH1.3]
	[F60-OP2.1, OP2.2, OP2.3]
	[F60-OS2.1, OS2.2, OS2.3]
9.14.6.1.	Surface Drainage
(1)	[F60-OH1.1, OH1.2, OH1.3]
	[F60-OP2.1, OP2.2, OP2.3]
	[F60-OS2.1, OS2.2, OS2.3]
9.14.6.2.	Drainage away from Wells or Leaching Beds
(1)	[F46-OH2.2] Applies to directing drainage away from the location of a water supply.
	[F44-OH2.1] Applies to directing drainage away from a septic tank disposal system.
9.14.6.3.	Window Wells
(1)	[F60-OH1.1, OH1.2, OH1.3]
	[F60-OP2.1, OP2.3]
	[F60-OS2.1, OS2.3]
9.14.6.4.	Catch Basin
(1)	[F60-OH1.1, OH1.2, OH1.3]
	[F61-OP2.3]
	[F61-OS2.3]
	[F61-OS3.1]

Acceptable Solution	Objectives and Functional Statements
9.14.6.5.	Downspouts
(1)	
9.15.1.1.	General
(1)	
(2)	
(3)	
(4)	
9.15.1.2.	Permafrost
(1)	
9.15.1.3.	Foundations for Deformation Resistant Buildings
(1)	[F20-OP2.2] [F22-OP2.4] [F20, F22-OP2.3] Applies to elements that support or are part of an environmental separator. [F22-OH1.1, OH1.2, OH1.3] Applies to elements that support or are part of an environmental separator. [F22-OH4] Applies to floors and elements that support floors. [F20-OS2.2] [F20, F22-OS2.3] Applies to elements that support or are part of an environmental separator. [F22-OS3.1] Applies to floors and elements that support floors. [F22-OS3.7] Applies to walls, and elements that support walls, that contain doors or windows required for emergency egress.
9.15.2.1.	Concrete
(1)	
9.15.2.2.	Unit Masonry Construction
(1)	[F20-OP2.1] [F21, F61-OP2.4] [F20, F21, F61-OP2.3] Applies to elements that support or are part of an environmental separator. [F20, F21, F61-OH1.1, OH1.2, OH1.3] Applies to elements that support or are part of an environmental separator. [F20, F21, F61-OH4] Applies to floors and elements that support floors. [F20-OS2.1] [F20, F21, F61-OS2.3] Applies to elements that support or are part of an environmental separator. [F20, F21, F61-OS3.1] Applies to floors and elements that support floors.
(2)	
(3)	(a) [F20-OP2.1] (a) [F80-OP2.4] (a) [F20, F80-OP2.3] Applies to elements that support or are part of an environmental separator. (a) [F20, F80-OH1.1, OH1.2, OH1.3] Applies to elements that support or are part of an environmental separator. (a) [F20, F80-OH4] Applies to floors and elements that support floors. (a) [F20-OS2.1] (a) [F20, F80-OS2.3] Applies to elements that support or are part of an environmental separator. (a) [F20, F80-OS3.1] Applies to floors and elements that support floors. (b) [F20-OP2.1] (b) [F20-OP2.4] (b) [F20, F80-OP2.3] Applies to elements that support or are part of an environmental separator. (b) [F20, F80-OH1.1, OH1.2, OH1.3] Applies to elements that support or are part of an environmental separator. (b) [F20, F80-OH4] Applies to floors and elements that support floors. (b) [F20-OS2.1] (b) [F20, F80-OS2.3] Applies to elements that support or are part of an environmental separator. (b) [F20, F80-OS3.1] Applies to floors and elements that support floors. (c) [F20-OP2.1] (c) [F61-OP2.4] (c) [F20, F61-OP2.3] Applies to elements that support or are part of an environmental separator. (c) [F20, F61-OH1.1, OH1.2, OH1.3] Applies to elements that support or are part of an environmental separator. (c) [F20, F61-OH4] Applies to floors and elements that support floors.

Acceptable Solution	Objectives and Functional Statements
(3) (Cont'd)	(c) [F20-OS2.1] (c) [F20, F61-OS2.3] Applies to elements that support or are part of an environmental separator. (c) [F20, F61-OS3.1] Applies to floors and elements that support floors.
9.15.2.3.	Pier Type Foundations
(1)	[F20-OP2.1, OP2.2] [F22-OP2.4] [F20, F22-OP2.3] Applies to elements that support or are part of an environmental separator. [F20, F22-OH1.1, OH1.2, OH1.3] Applies to elements that support or are part of an environmental separator. [F20, F22-OH4] Applies to floors and elements that support floors. [F20-OS2.1, OS2.2] [F20, F22-OS2.3] Applies to elements that support or are part of an environmental separator. [F20, F22-OS3.1] Applies to floors and elements that support floors.
(2)	[F20-OP2.1, OP2.2] [F22-OP2.4] [F20, F22-OP2.3] Applies to elements that support or are part of an environmental separator. [F20, F22-OH1.1, OH1.2, OH1.3] Applies to elements that support or are part of an environmental separator. [F20, F22-OH4] Applies to floors and elements that support floors. [F20-OS2.1, OS2.2] [F20, F22-OS2.3] Applies to elements that support or are part of an environmental separator. [F20, F22-OS3.1] Applies to floors and elements that support floors.
(3)	[F20-OP2.1, OP2.4, OP2.5] [F22-OP2.4, OP2.5] [F20, F22-OP2.3] Applies to elements that support or are part of an environmental separator. [F20, F22-OH1.1, OH1.2, OH1.3] Applies to elements that support or are part of an environmental separator. [F20, F22-OH4] Applies to floors and elements that support floors [F20, F22-OS2.3] Applies to elements that support or are part of an environmental separator. [F20, F22-OS3.1] Applies to floors and elements that support floors.
(4)	[F20-OP2.1, OP2.4] [F22-OP2.4, OP2.5] [F20, F22-OP2.3] Applies to elements that support or are part of an environmental separator. [F20, F22-OH1.1, OH1.2, OH1.3] Applies to elements that support or are part of an environmental separator. [F20, F22-OH4] Applies to floors and elements that support floors. [F20-OS2.1, OS2.4] [F22-OS2.4, OS2.5] [F20, F22-OS2.3] Applies to elements that support or are part of an environmental separator. [F20, F22-OS3.1] Applies to floors and elements that support floors.
9.15.2.4.	Wood Frame Foundations
(1)	(a) [F20-OP2.1, OP2.2] (a) [F20, F80-OP2.3] Applies to elements support or are part of an environmental separator. (a) [F20, F80-OH1.1, OH1.2, OH1.3] Applies to elements that support or are part of an environmental separator. (a) [F20, F80-OH4] Applies to floors and elements that support floors. (a) [F20-OS2.1, OS2.2] (a) [F20, F80-OS2.3] Applies to elements that support or are part of an environmental separator. (a) [F20, F80-OS3.1] Applies to floors and elements that support floors.
9.15.3.1.	Footings Required
(1)	[F20-OP2.2] [F20, F21-OP2.4] [F20, F21-OP2.3] Applies to elements that support or are part of an environmental separator. [F20, F21-OH1.1, OH1.2, OH1.3] Applies to elements that support or are part of an environmental separator. [F20, F21-OH4] Applies to floors and elements that support floors. [F20-OS2.2] [F20, F21-OS2.3] Applies to elements that support or are part of an environmental separator. [F20, F21-OS3.1] Applies to floors and elements that support floors.

Acceptable Solution	Objectives and Functional Statements
9.15.3.2.	Support of Footings
(1)	[F21-OH1.1, OH1.2, OH1.3] Applies to elements that support or are part of an environmental separator. [F21-OH4] Applies to floors and elements that support floors. [F21-OP2.4] [F21-OP2.3] Applies to elements that support or are part of an environmental separator. [F21-OS2.4] [F21-OS2.3] Applies to elements that support or are part of an environmental separator. [F21-OS3.1] Applies to floors and elements that support floors.
(2)	[F21-OH1.1, OH1.2, OH1.3] Applies to elements that support or are part of an environmental separator. [F21-OH4] Applies to floors and elements that support floors. [F21-OP2.1, OP2.4] [F21-OP2.3] Applies to elements that support or are part of an environmental separator. [F21-OS2.1] [F21-OS2.3] Applies to elements that support or are part of an environmental separator. [F21-OS3.1] Applies to floors and elements that support floors.
9.15.3.3.	Application of Footing Width and Area Requirements
(1)	
(2)	
(3)	
9.15.3.4.	Basic Footing Widths and Areas
(1)	[F20-OP2.1] [F21-OP2.4] [F20, F21-OP2.3] Applies to elements that support or are part of an environmental separator. [F20, F21-OH1.1, OH1.2, OH1.3] Applies to elements that support or are part of an environmental separator. [F20, F21-OH4] Applies to floors and elements that support floors. [F20-OS2.2] [F20, F21-OS2.3] Applies to elements that support or are part of an environmental separator. [F20, F21-OS3.1] Applies to floors and elements that support floors.
(2)	[F20-OP2.2] [F21-OP2.4] [F20, F21-OP2.3] Applies to elements that support or are part of an environmental separator. [F20, F21-OH1.1, OH1.2, OH1.3] Applies to elements that support or are part of an environmental separator. [F20, F21-OH4] Applies to floors and elements that support floors. [F20-OS2.2] [F20, F21-OS2.3] Applies to elements that support or are part of an environmental separator. [F20, F21-OS3.1] Applies to floors and elements that support floors.
(3)	[F20-OP2.2] [F21-OP2.4] [F20, F21-OP2.3] Applies to elements that support or are part of an environmental separator. [F20, F21-OH1.1, OH1.2, OH1.3] Applies to elements that support or are part of an environmental separator. [F20, F21-OH4] Applies to floors and elements that support floors. [F20-OS2.2] [F20, F21-OS2.3] Applies to elements that support or are part of an environmental separator. [F20, F21-OS3.1] Applies to floors and elements that support floors.
9.15.3.5.	Adjustments to Footing Widths for Exterior Walls
(1)	[F20-OP2.2, OP2.3] [F21-OP2.3, OP2.4] [F20-OS2.2, OS2.3] [F21-OS2.3] [F20, F21-OH1.1, OH1.2, OH1.3] [F20, F21-OH4] Applies to floors and elements that support floors. [F20, F21-OS3.1] Applies to floors and elements that support floors.
9.15.3.6.	Adjustments to Footing Widths for Interior Walls
(1)	[F20-OP2.2] [F21-OP2.4] [F20, F21-OP2.3] Applies to elements that support or are part of an environmental separator.

Acceptable Solution	Objectives and Functional Statements
(1) (Cont'd)	[F20, F21-OH1.1, OH1.2, OH1.3] Applies to elements that support or are part of an environmental separator. [F20, F21-OH4] Applies to floors and elements that support floors. [F20-OS2.2] [F20, F21-OS2.3] Applies to elements that support or are part of an environmental separator. [F20, F21-OS3.1] Applies to floors and elements that support floors.
(2)	[F20-OP2.2] [F10-OS2.2]
9.15.3.7.	Adjustments to Footing Area for Columns
(1)	[F20-OP2.2] [F21-OP2.4] [F20, F21-OP2.3] Applies to elements that support or are part of an environmental separator. [F20, F21-OH1.1, OH1.2, OH1.3] Applies to elements that support or are part of an environmental separator. [F20, F21-OH4] Applies to floors and elements that support floors. [F20-OS2.2] [F20, F21-OS2.3] Applies to elements that support or are part of an environmental separator. [F20, F21-OS3.1] Applies to floors and elements that support floors.
9.15.3.8.	Footing Thickness
(1)	[F20-OH1.1, OH1.2, OH1.3] Applies to elements that support or are part of an environmental separator. [F20-OH4] Applies to floors and elements that support floors. [F20-OP2.1, OP2.4] [F20-OP2.3] Applies to elements that support or are part of an environmental separator. [F20-OS2.1] [F20-OS2.3] Applies to elements that support or are part of an environmental separator. [F20-OS3.1] Applies to floors and elements that support floors.
9.15.3.9.	Step Footings
(1)	[F20, F22-OP2.3, OP2.4] [F20, F22-OH1.1, OH1.2, OH1.3] Applies where the <i>foundation</i> supports or is part of an environmental separator. [F20, F22-OH4] Applies to <i>foundations</i> that support floors. [F20, F22-OS2.3, OS2.4] [F20, F22-OS3.1] Applies to <i>foundations</i> that support floors.
9.15.4.1.	Permanent Form Material
(1)	[F22, F55, F63-OH1.1, OH1.2, OH1.3]
9.15.4.2.	Foundation Wall Thickness and Required Lateral Support
(1)	[F20-OP2.1, OP2.3] [F22-OP2.3, OP2.4] [F20, F22-OH1.1, OH1.2, OH1.3] [F20, F22-OH4] Applies to floors and elements that support floors. [F20-OS2.1, OS2.3] [F22-OS2.3] [F20, F22-OS3.1] Applies to floors and elements that support floors.
(2)	[F20-OP2.1, OP2.3] [F22-OP2.3, OP2.4] [F20, F22-OH1.1, OH1.2, OH1.3] [F20, F22-OH4] Applies to floors and elements that support floors. [F20-OS2.1, OS2.3] [F22-OS2.3] [F20, F22-OS3.1] Applies to floors and elements that support floors.
(3)	[F20-OP2.1, OP2.3] [F22-OP2.3, OP2.4] [F20, F22-OH1.1, OH1.2, OH1.3] [F20, F22-OH4] Applies to floors and elements that support floors. [F20-OS2.1, OS2.3] [F22-OS2.3, OS2.4] [F20, F22-OS3.1] Applies to floors and elements that support floors.
(4)	[F20-OP2.1, OP2.3] [F22-OP2.3, OP2.4] [F20, F22-OH1.1, OH1.2, OH1.3] [F20, F22-OH4] Applies to floors and elements that support floors. [F20-OS2.1, OS2.3] [F22-OS2.3] [F20, F22-OS3.1] Applies to floors and elements that support floors.

Acceptable Solution	Objectives and Functional Statements
(5)	[F20-OP2.1, OP2.3] [F22-OP2.3, OP2.4] [F20, F22-OH1.1, OH1.2, OH1.3] [F20, F22-OH4] Applies to floors and elements that support floors. [F20-OS2.1, OS2.3] [F22-OS3.2, OS2.4] [F20, F22-OS3.1] Applies to floors and elements that support floors.
(6)	[F20-OP2.1, OP2.3] [F22-OP2.3, OP2.4] [F20, F22-OH1.1, OH1.2, OH1.3] [F20, F22-OH4] Applies to floors and elements that support floors. [F20-OS2.1, OS2.3] [F22-OS2.3, OS2.4] [F20, F22-OS3.1] Applies to floors and elements that support floors.
(7)	[F20-OP2.1, OP2.3] [F22-OP2.3, OP2.4] [F20, F22-OH1.1, OH1.2, OH1.3] [F20, F22-OH4] Applies to floors and elements that support floors. [F20-OS2.1, OS2.3] [F22-OS2.3, OS2.4] [F20, F22-OS3.1] Applies to floors and elements that support floors.
(8)	[F20-OP2.1, OP2.3] [F22-OP2.3, OP2.4] [F20, F22-OH1.1, OH1.2, OH1.3] [F20, F22-OH4] Applies to floors and elements that support floors. [F20-OS2.1, OS2.3] [F22-OS2.3, OS2.4] [F20, F22-OS3.1] Applies to floor and elements that support floors.
9.15.4.3.	Foundation Walls Considered to be Laterally Supported at the Top
(1)	
(2)	
(3)	
(4)	
(5)	
9.15.4.4.	Foundation Walls Considered to be Laterally Supported at the Bottom
(1)	
9.15.4.5.	Reinforcement for Flat Insulating Concrete Form Foundation Walls
(1)	[F20-OP2.1, OP2.3] [F22-OP2.3, OP2.4] [F20, F22-OH1.1, OH1.2, OH1.3] [F20, F22-OH4] Applies to floors and elements that support floors. [F20-OS2.1, OS2.3] [F22-OS2.3, OS2.4] [F20, F22-OS3.1] Applies to floors and elements that support floors.
(2)	[F20-OP2.1, OP2.3] [F22-OP2.3, OP2.4] [F20, F22-OH1.1, OH1.2, OH1.3] [F20, F22-OH4] Applies to floors and elements that support floors. [F20-OS2.1, OS2.3] [F22-OS2.3, OS2.4] [F20, F22-OS3.1] Applies to floors and elements that support floors.
(3)	[F20-OP2.1, OP2.3] [F22-OP2.3, OP2.4] [F20, F22-OH1.1, OH1.2, OH1.3] [F20, F22-OH4] Applies to floors and elements that support floors. [F20-OS2.1, OS2.3] [F22-OS2.3, OS2.4] [F20, F22-OS3.1] Applies to floors and elements that support floors.
(4)	[F20-OP2.1, OP2.3] [F22-OP2.3, OP2.4] [F20, F22-OH1.1, OH1.2, OH1.3] [F20, F22-OH4] Applies to floors and elements that support floors. [F20-OS2.1, OS2.3] [F22-OS2.3, OS2.4] [F20, F22-OS3.1] Applies to floors and elements that support floors.
9.15.4.6.	Extension above Ground Level
(1)	[F61-OH1.1, OH1.2, OH1.3] [F61-OP2.3]

Acceptable Solution	Objectives and Functional Statements
(1) (Cont'd)	[F61-OS2.3]
9.15.4.7.	Reduction in Thickness
(1)	[F20-OH1.1, OH1.2, OH1.3] Applies to elements that support or are part of an environmental separator. [F20-OH4] Applies to floors and elements that support floors. [F20-OP2.1, OP2.4] [F20-OP2.3] Applies to elements that support or are part of an environmental separator. [F20-OS2.1] [F20-OS2.3] Applies to elements that support or are part of an environmental separator. [F20-OS3.1] Applies to floors and elements that support floors.
(2)	[F20-OH1.1, OH1.2, OH1.3] Applies to elements that support or are part of environmental separator. [F20-OH4] Applies to floors and elements that support floors. [F20-OP2.1, OP2.4] [F20-OP2.3] Applies to elements that support or are part of an environmental separator. [F20-OS2.1] [F20-OS2.3] Applies to elements that support or are part of an environmental separator. [F20-OS3.1] Applies to floors and elements that support floors.
(3)	[F20-OH1.1, OH1.2, OH1.3] Applies to elements that support or are part of an environmental separator. [F20-OH4] Applies to floors and elements that support floors. [F20-OP2.1, OP2.4] [F20-OP2.3] Applies to elements that support or are part of an environmental separator. [F20-OS2.1] [F20-OS2.3] Applies to elements that support or are part of an environmental separator. [F20-OS3.1] Applies to floors and elements that support floors.
9.15.4.8.	Corbelling
(1)	
9.15.4.9.	Crack Control Joints
(1)	[F21-OP2.3] [F21-OS2.3] [F21-OH1.1, OH1.2, OH1.3] Applies to elements that support or are part of an environmental separator.
(2)	[F20-OP2.1] [F20, F61-OP2.3] Applies to elements that support or are part of an environmental separator. [F20-OS2.1] [F20, F61-OS2.3] Applies to elements that support or are part of an environmental separator. [F61-OH1.1, OH1.2, OH1.3] Applies to elements that support or are part of an environmental separator.
9.15.4.10.	Interior Masonry Walls
(1)	
9.15.5.1.	Support of Floor Joists
(1)	[F20-OP2.1, OP2.4] [F20-OP2.3] [F40, F61-OP2.3, OP2.4] Applies to elements that support or are part of an environmental separator. [F20, F40, F61-OH1.1, OH1.2, OH1.3] Applies to elements that support or are part of an environmental separator. [F20, F40, F61-OH4] Applies to floors and elements that support floors. [F20-OS2.1] [F40, F61-OS2.3] Applies to elements that support or are part of an environmental separator. [F20, F40, F61-OS3.1] Applies to floors and elements that support floors.
(2)	
9.15.5.2.	Support of Beams
(1)	[F20-OH1.1, OH1.2, OH1.3] Applies to elements that support or are part of an environmental separator. [F20-OH4] Applies to floors and elements that support floors. [F20-OP2.1, OP2.4] [F20-OP2.3] Applies to elements that support or are part of an environmental separator. [F20-OS2.1] [F20-OS2.3] Applies to elements that support or are part of an environmental separator. [F20-OS3.1] Applies to floors and elements that support floors.

Acceptable Solution	Objectives and Functional Statements
(2)	[F80-OH1.1, OH1.2, OH1.3] Applies to elements that support or are part of an environmental separator. [F80-OH4] Applies to floors and elements that support floors. [F80-OP2.3, OP2.4] Applies to elements that support or are part of an environmental separator. [F80-OS2.3] Applies to elements that support or are part of an environmental separator. [F80-OS3.1] Applies to floors and elements that support floors.
9.15.5.3.	Pilasters
(1)	[F20-OH1.1, OH1.2, OH1.3] Applies to elements that support or are part of an environmental separator. [F20-OH4] Applies to floors and elements that support floors. [F20-OP2.1, OP2.4] [F20-OP2.3] Applies to elements that support or are part of an environmental separator. [F20-OS2.1] [F20-OS2.3] Applies to elements that support or are part of an environmental separator. [F20-OS3.1] Applies to floors and elements that support floors.
(2)	[F20-OH1.1, OH1.2, OH1.3] Applies to elements that support or are part of an environmental separator. [F20-OH4] Applies to floors and elements that support floors. [F20-OP2.1, OP2.4] [F20-OP2.3] Applies to elements that support or are part of an environmental separator. [F20-OS2.1] [F20-OS2.3] Applies to elements that support or are part of an environmental separator. [F20-OS3.1] Applies to floors and elements that support floors.
(3)	[F20-OH1.1, OH1.2, OH1.3] Applies to elements that support or are part of an environmental separator. [F20-OH4] Applies to floors and elements that support floors. [F20-OP2.1, OP2.4] [F20-OP2.3] Applies to elements that support or are part of an environmental separator. [F20-OS2.1] [F20-OS2.3] Applies to elements that support or are part of an environmental separator. [F20-OS3.1] Applies to floors and elements that support floors.
9.15.6.1.	Foundation Walls Below Ground
(1)	
9.15.6.2.	Foundation Walls Above Ground
(1)	[F61-OH1.1, OH1.2, OH1.3] [F61-OP2.3] [F61-OS2.3]
9.15.6.3.	Form Ties
(1)	[F61-OH1.1, OH1.2, OH1.3] Applies to elements that support or are part of an environmental separator. [F61-OP2.3] Applies to elements that support or are part of an environmental separator. [F61-OS2.3] Applies to elements that support or are part of an environmental separator. [F30-OS3.1]
9.16.1.1.	Application
(1)	
9.16.1.2.	Structural Floor Slabs
(1)	
9.16.1.3.	Required Floors-on-Ground
(1)	(a), (b) [F30-OS3.1] (a), (b) [F40-OH2.4]
9.16.1.4.	Dampproofing and Waterproofing
(1)	
9.16.2.1.	Required Installation of Granular Fill
(1)	[F40, F61-OH1.1] [F61, F60-OH1.2, OH1.3] [F60-OS2.3]
(2)	

Acceptable Solution	Objectives and Functional Statements
9.16.2.2.	Support of Floors
(1)	[F21-OH1.1, OH1.2, OH1.3] [F21-OP2.1, OP2.3, OP2.4] [F21-OS2.1, OS2.3] [F21-OS3.1]
(2)	[F21-OH1.1, OH1.2, OH1.3] [F21-OP2.1, OP2.3, OP2.4] [F21-OS2.1, OS2.3] [F21-OS3.1]
(3)	[F22-OS3.1]
(4)	
9.16.3.1.	Control of Water Ingress
(1)	[F60-OH1.1, OH1.2, OH1.3] [F60-OS2.3] [F60-OS3.1]
9.16.3.2.	Hydrostatic Pressure
(1)	[F20-OH1.1, OH1.2, OH1.3] [F20-OP2.1] [F61-OP2.6] [F20-OS2.1] [F61-OS2.3] [F20-OS3.1]
9.16.3.3.	Floor Drains
(1)	[F62-OH1.1, OH1.2, OH1.3] [F62-OS2.3] [F62-OS3.1]
9.16.4.1.	Surface Finish
(1)	[F30, F80-OS3.1] [F40-OH2.4] [F62-OH1.1, OH1.2, OH1.3]
(2)	[F20, F80-OS3.1] [F41-OH1.1]
9.16.4.2.	Topping Course
(1)	[F20, F80-OS3.1]
(2)	[F20, F80-OS3.1]
9.16.4.3.	Thickness
(1)	[F20-OH1.1, OH1.2, OH1.3] [F20-OH4] [F20-OP2.1, OP2.3] [F20-OS2.1, OS2.3] [F20-OS3.1]
9.16.4.4.	Bond Break
(1)	[F21-OS3.1]
9.16.4.5.	Compressive Strength
(1)	[F61-OH1.1, OH1.2, OH1.3] [F61-OS2.3]
(2)	[F20, F80-OS2.1, OS2.3] [F20, F80-OP2.3]
9.16.5.1.	Wood Frame Floors
(1)	[F20-OH1.1, OH1.2, OH1.3] Applies where wood-frame floors-on-ground serve as an environmental separator. [F20-OH4] [F20-OP2.1] [F20-OP2.3] Applies where wood-frame floors-on-ground serve as an environmental separator.

Acceptable Solution	Objectives and Functional Statements
(1) (Cont'd)	[F20-OS2.1] [F20-OS2.3] Applies where wood-frame floors-on-ground serve as an environmental separator. [F20-OS3.1]
9.17.1.1.	Application
(1)	
(2)	
9.17.2.1.	Location
(1)	[F20-OH1.1, OH1.2, OH1.3] Applies to elements that support or are part of an environmental separator. [F20-OH4] Applies to floors and elements that support floors. [F20-OP2.2, OP2.4] [F20-OP2.3] Applies to elements that support or are part of an environmental separator. [F20-OS2.2] [F20-OS2.3] Applies to elements that support or are part of an environmental separator. [F20-OS3.1] Applies to floors and elements that support floors.
9.17.2.2.	Lateral Support
(1)	[F22-OH1.1, OH1.2, OH1.3] Applies to elements that support or are part of an environmental separator. [F22-OH4] Applies to floors and elements that support floors. [F22-OP2.4, OP2.5] [F22-OP2.3] Applies to elements that support or are part of an environmental separator. [F22-OS2.4, OS2.5] [F22-OS2.3] Applies to elements that support or are part of an environmental separator. [F22-OS3.1] Applies to floors and elements that support floors. [F22-OS3.7] Applies to walls, and elements that support walls, that contain doors or windows required for emergency egress.
(2)	[F22-OH1.1, OH1.2, OH1.3] Applies to elements that support or are part of an environmental separator. [F22-OH4] Applies to floors and elements that support floors. [F22-OP2.4, OP2.5] [F22-OP2.3] Applies to elements that support or are part of an environmental separator. [F22-OS2.4, OS2.5] [F22-OS2.3] Applies to elements that support or are part of an environmental separator. [F22-OS3.1] Applies to floors and elements that support floors. [F22-OS3.7] Applies to walls, and elements that support walls, that contain doors or windows required for emergency egress.
(3)	
9.17.3.1.	Size and Thickness
(1)	[F20-OP2.1] [F20, F22-OP2.4] [F20, F22-OP2.3] Applies to elements that support or are part of an environmental separator. [F20, F22-OH1.1, OH1.2, OH1.3] Applies to elements that support or are part of an environmental separator. [F20, F22-OH4] Applies to floors and elements that support floors. [F20-OS2.1] [F20, F22-OS2.3] Applies to elements that support or are part of an environmental separator. [F20, F22-OS3.1] Applies to floors and elements that support floors.
(2)	[F20-OP2.1] [F20, F22-OP2.4] [F20, F22-OP2.3] Applies to elements that support or are part of an environmental separator. [F20, F22-OH1.1, OH1.2, OH1.3] Applies to elements that support or are part of an environmental separator. [F20, F22-OH4] Applies to floors and elements that support floors. [F20-OS2.1] [F20, F22-OS2.3] Applies to elements that support or are part of an environmental separator. [F20, F22-OS3.1] Applies to floors and elements that support floors.
9.17.3.2.	End Bearing Plates
(1)	[F20-OP2.1] [F20, F22-OP2.4] [F20, F22-OP2.3] Applies to elements that support or are part of an environmental separator.

Acceptable Solution	Objectives and Functional Statements
(1) (Cont'd)	[F20, F22-OH1.1, OH1.2, OH1.3] Applies to elements that support or are part of an environmental separator. [F20, F22-OH4] Applies to floors and elements that support floors. [F20-OS2.1] [F20, F22-OS2.3] Applies to elements that support or are part of an environmental separator. [F20, F22-OS3.1] Applies to floors and elements that support floors.
(2)	
9.17.3.3.	Paint
(1)	[F80-OH1.1, OH1.2, OH1.3] [F80-OP2.3, OP2.4] [F80-OH4] Applies to floors and elements that support floors. [F80-OS2.3] [F80-OS3.1] Applies to floors and elements that support floors.
9.17.3.4.	Design of Adjustable Steel Columns
(1)	[F20-OP2.1] [F22-OP2.4] [F20, F22-OP2.3] Applies to elements that support or are part of an environmental separator. [F20, F22-OH1.1, OH1.2, OH1.3] Applies to elements that support or are part of an environmental separator. [F20, F22-OH4] Applies to floors and elements that support floors. [F20-OS2.1] [F22-OS2.4] [F20, F22-OS2.3] Applies to elements that support or are part of an environmental separator. [F20, F22-OS3.1] Applies to floors and elements that support floors. [F20, F22-OS3.7] Applies to walls, and elements that support walls, that contain doors or windows required for emergency egress.
(2)	
9.17.4.1.	Column Sizes
(1)	[F20-OP2.1] [F20, F22-OP2.4] [F20, F22-OP2.3] Applies to elements that support or are part of an environmental separator. [F20, F22-OH1.1, OH1.2, OH1.3] Applies to elements that support or are part of an environmental separator. [F20, F22-OH4] Applies to floors and elements that support floors. [F20-OS2.1] [F20, F22-OS2.3] Applies to elements that support or are part of an environmental separator. [F20, F22-OS3.1] Applies to floors and elements that support floors.
(2)	[F20-OP2.1] [F20, F22-OP2.4] [F20, F22-OP2.3] Applies to elements that support or are part of an environmental separator. [F20, F22-OH1.1, OH1.2, OH1.3] Applies to elements that support or are part of an environmental separator. [F20, F22-OH4] Applies to floors and elements that support floors. [F20-OS2.1] [F20, F22-OS2.3] Applies to elements that support or are part of an environmental separator. [F20, F22-OS3.1] Applies to floors and elements that support floors.
9.17.4.2.	Materials
(1)	[F20-OP2.1] [F20, F22-OP2.4] [F20, F22-OP2.3] Applies to elements that support or are part of an environmental separator. [F20, F22-OH1.1, OH1.2, OH1.3] Applies to elements that support or are part of an environmental separator. [F20, F22-OH4] Applies to floors and elements that support floors. [F20-OS2.1] [F20, F22-OS2.3] Applies to elements that support or are part of an environmental separator. [F20, F22-OS3.1] Applies to floors and elements that support floors.
(2)	[F20-OP2.1] [F20, F22-OP2.4] [F20, F22-OP2.3] Applies to elements that support or are part of an environmental separator.

Acceptable Solution	Objectives and Functional Statements
(2) (Cont'd)	[F20, F22-OH1.1, OH1.2, OH1.3] Applies to elements that support or are part of an environmental separator. [F20, F22-OH4] Applies to floors and elements that support floors. [F20-OS2.1] [F20, F22-OS2.3] Applies to elements that support or are part of an environmental separator. [F20, F22-OS3.1] Applies to floors and elements that support floors.
(3)	
9.17.4.3.	Columns in Contact with Concrete
(1)	[F80-OH1.1, OH1.2, OH1.3] Applies to elements that support or are part of an environmental separator. [F80-OH4] Applies to floors and elements that support floors. [F80-OP2.4] [F80-OP2.3] Applies to elements that support or are part of an environmental separator. [F80-OS2.3] Applies to elements that support or are part of an environmental separator. [F80-OS3.1] Applies to floors and elements that support floors.
9.17.4.4.	Wood Column Termite Protection
(1)	[F80, F82-OP2.3, OP2.4] [F80, F82-OS2.3]
9.17.5.1.	Materials
(1)	[F20-OP2.1] [F20, F22-OP2.4] [F20, F22-OP2.3] Applies to elements that support or are part of an environmental separator. [F20, F11-OH1.1, OH1.2, OH1.3] Applies to elements that support or are part of an environmental separator. [F20, F22-OH4] Applies to floors and elements that support floors. [F20-OS2.1] [F20, F22-OS2.3] Applies to elements that support or are part of an environmental separator. [F20, F22-OS3.1] Applies to floors and elements that support floors.
9.17.5.2.	Sizes
(1)	[F20-OP2.1] [F20, F22-OP2.4] [F20, F22-OP2.3] Applies to elements that support or are part of an environmental separator. [F20, F22-OH1.1, OH1.2, OH1.3] Applies to elements that support or are part of an environmental separator. [F20, F22-OH4] Applies to floors and elements that support floors. [F20-OS2.1] [F20, F22-OS2.3] Applies to elements that support or are part of an environmental separator. [F20, F22-OS3.1] Applies to floors and elements that support floors.
9.17.6.1.	Materials
(1)	
9.17.6.2.	Sizes
(1)	[F20-OP2.1] [F20, F22-OP2.4] [F20, F22-OP2.3] Applies to elements that support or are part of an environmental separator. [F20, F22-OH1.1, OH1.2, OH1.3] Applies to elements that support or are part of an environmental separator. [F20, F22-OH4] Applies to floors and elements that support floors. [F20-OS2.1] [F20, F22-OS2.3] Applies to elements that support or are part of an environmental separator. [F20, F22-OS3.1] Applies to floors and elements that support floors.
9.18.1.1.	Application
(1)	
9.18.1.2.	Foundations
(1)	
9.18.1.3.	Heated and Unheated Crawl Spaces
(1)	
(2)	
(3)	

Acceptable Solution	Objectives and Functional Statements
9.18.2.1.	Access Openings
(1)	[F82-OH1.1, OH1.2]
(2)	[F42-OH2.4, OH2.5] Applies where crawl spaces are heated or unheated and access is from the exterior. [F51, F63-OS2.3] Applies where crawl spaces are unheated and access is from the interior. [F42, F61-OS2.3] Applies where crawl spaces are heated or unheated and access is from the exterior. [F63-OS2.3] Applies where crawl spaces are unheated and access is from the interior. [F42, F61-OS2.3] Applies where crawl spaces are heated or unheated and access is from the exterior.
9.18.3.1.	Ventilation of Unheated Crawl Spaces
(1)	[F62-OH1.1] [F62-OS2.3]
(2)	[F62-OH1.1] [F62-OS2.3]
(3)	(a) [F62-OH1.1, OH1.2] (a), (b) [F42, F61, F62-OS2.3] (b) [F42, F61-OH1.1, OH1.2] (b) [F42-OH2.3, OH2.5]
9.18.3.2.	Ventilation of Heated Crawl Spaces
(1)	
9.18.4.1.	Access Way to Services
(1)	[F82-OH1.1, OH1.2] [F82-OH2.1]
9.18.5.1.	Drainage
(1)	[F60-OH1.1, OH1.2] [F60-OS2.3]
(2)	
(3)	
(4)	
9.18.6.1.	Ground Cover in Unheated Crawl Spaces
(1)	[F61-OH1.1, OH1.2] [F61-OS2.3]
(2)	[F61-OH1.1, OH1.2] [F61-OS2.3]
9.18.6.2.	Ground Cover in Heated Crawl Spaces
(1)	[F40, F61-OH1.1] [F61-OH1.2] [F61-OS2.3]
(2)	[F40, F61-OH1.1] [F61-OH1.2] [F61-OS2.3]
(3)	[F40-OH1.1]
9.18.7.1.	Crawl Spaces as Warm Air Plenums
(1)	[F51-OH1.1, OH1.2] [F51-OS2.3]
(2)	[F02-OS1.2]
(3)	[F01-OS1.1]
(4)	[F01-OS1.1]
9.19.1.1.	Required Venting
(1)	[F51, F62-OS2.3] [F51, F62-OH1.1, OH1.2] [F51-OH1.3] Applies to sloped roof assemblies that may be subject to ice damming.
9.19.1.2.	Vent Requirements
(1)	[F51, F62-OS2.3] [F51, F62-OH1.1, OH1.2] [F51-OH1.3] Applies to sloped roof assemblies that may be subject to ice damming.

r3

Acceptable Solution	Objectives and Functional Statements
(2)	[F51, F62-OS2.3] [F51, F62-OH1.1, OH1.2] [F51-OH1.3] Applies to sloped roof assemblies that may be subject to ice damming.
(3)	[F51, F62-OS2.3] [F51, F62-OH1.1, OH1.2] [F51-OH1.3] Applies to sloped roof assemblies that may be subject to ice damming.
(4)	[F51, F62-OS2.3] [F51, F61-OH1.1, OH1.2] [F51-OH1.3] Applies to sloped roof assemblies that may be subject to ice damming.
(5)	[F42, F51, F61, F62-OS2.3] [F42-OH1.1] Applies to resistance to the entry of insects. [F51, F61, F62-OH1.1, OH1.2, OH1.3] [F42-OH2.5] Applies to resistance to the entry of insects.
9.19.1.3.	Clearances
(1)	[F51, F62-OH1.1, OH1.2, OH1.3] [F51, F62-OS2.3]
(2)	[F51, F62-OH1.1, OH1.2, OH1.3] [F51, F62-OS2.3]
(3)	[F51, F62-OH1.1, OH1.2, OH1.3] [F51, F62-OS2.3]
9.19.1.4.	Mansard or Gambrel Roof
(1)	
(2)	
9.19.2.1.	Access
(1)	[F82-OH1.1, OH1.2, OH1.3] [F82-OS2.3]
(2)	[F82-OH1.1, OH1.2] [F82-OS2.3]
(3)	[F42-OH1.1] Applies where access is from an unheated enclosed space. [F51-OH1.2] Applies where access is from an interior heated space. [F42-OH1.1] [F61-OH1.1, OH1.2, OH1.3] Applies where access is from the exterior. [F42-OH2.5] Applies where access is from the exterior or an unheated enclosed space. [F42, F61-OS2.3] Applies where access is from the exterior or an unheated enclosed space.
9.20.1.1.	General
(1)	
(2)	
9.20.1.2.	Earthquake Reinforcement
(1)	
(2)	
9.20.2.1.	Masonry Unit Standards
(1)	[F20, F80-OH1.1, OH1.2, OH1.3] Applies to elements that support or are part of an environmental separator and to masonry used in <i>chimneys</i> and fireplaces. [F20, F80-OH4] Applies to floors and elements that support floors. [F01-OP1.2] Applies to masonry used in <i>chimneys</i> and fireplaces. [F20, F80-OP1.2] Applies to assemblies required to provide fire resistance. [F20, F80-OP2.1, OP2.4] [F20, F80-OP2.3] Applies to elements that support or are part of an environmental separator or are exposed to moisture. [F01-OS1.1, OS1.2] Applies to masonry used in <i>chimneys</i> and fireplaces. [F20, F80-OS1.2] Applies to assemblies required to provide fire resistance. [F20, F80-OS2.1] [F20, F80-OS2.3] Applies to elements that support or are part of an environmental separator or are exposed to moisture. [F20, F80-OS3.1] Applies to floors and elements that support floors. [F20, F80-OS3.4] Applies to masonry used in <i>chimneys</i> and fireplaces.

Acceptable Solution	Objectives and Functional Statements
9.20.2.2.	Used Brick
(1)	<p>[F20, F80-OH1.1, OH1.2, OH1.3] Applies to elements that support or are part of an environmental separator and to masonry used in <i>chimneys</i> and fireplaces.</p> <p>[F20, F80-OH4] Applies to floors and elements that support floors.</p> <p>[F01-OP1.2] Applies to masonry used in <i>chimneys</i> and fireplaces. [F20, F80-OP1.2] Applies to assemblies required to provide fire resistance.</p> <p>[F20, F80-OP2.1, OP2.4] [F20, F80-OP2.3] Applies to elements that support or are part of an environmental separator or are exposed to moisture.</p> <p>[F01-OS1.1, OS1.2] Applies to masonry used in <i>chimneys</i> and fireplaces. [F20, F80-OS1.2] Applies to assemblies required to provide fire resistance.</p> <p>[F20, F80-OS2.1] [F20, F80-OS2.3] Applies to elements that support or are part of an environmental separator or are exposed to moisture.</p> <p>[F20, F80-OS3.1] Applies to floors and elements that support floors. [F20, F80-OS3.4] Applies to masonry used in <i>chimneys</i> and fireplaces.</p>
9.20.2.3.	Glass Blocks
(1)	<p>[F20-OH1.1, OH1.2, OH1.3] Applies to elements that support or are part of an environmental separator and to masonry used in <i>chimneys</i> and fireplaces.</p> <p>[F20-OH4] Applies to floors and elements that support floors.</p> <p>[F01, F20-OP1.1] [F20-OP1.2] Applies to assemblies required to provide fire resistance.</p> <p>[F20-OP2.1, OP2.4] [F20-OP2.3] Applies to elements that support or are part of an environmental separator or are exposed to moisture.</p> <p>[F01, F20-OS1.1] [F20-OS1.2] Applies to assemblies required to provided fire resistance.</p> <p>[F20-OS2.1] [F20-OS2.3] Applies to elements that support or are part of an environmental separator or are exposed to moisture.</p> <p>[F20-OS3.1] Applies to floors and elements that support floors. [F01, F20-OS3.4] Applies to masonry used in <i>chimneys</i> and fireplaces.</p>
9.20.2.4.	Cellular Concrete
(1)	<p>[F80-OH1.1, OH1.2, OH1.3] Applies to elements that support or are part of an environmental separator and to masonry used in <i>chimneys</i> and fireplaces.</p> <p>[F80-OH4] Applies to floors and elements that support floors.</p> <p>[F80-OP1.2] Applies to masonry used in <i>chimneys</i> and fireplaces.</p> <p>[F80-OS1.2] Applies to masonry used in <i>chimneys</i> and fireplaces.</p> <p>[F80-OP1.2, OP2.4] [F80-OP2.3] Applies to elements that support or are part of an environmental separator or are exposed to moisture.</p> <p>[F80-OS2.1] [F80-OS2.3] Applies to elements that support or are part of an environmental separator or are exposed to moisture.</p> <p>[F80-OS3.1] Applies to floors and elements that support floors. [F80-OS3.4] Applies to masonry used in <i>chimneys</i> and fireplaces.</p>
9.20.2.5.	Stone
(1)	<p>[F20, F80-OH1.1, OH1.2, OH1.3] Applies to elements that support or are part of an environmental separator and to masonry used in <i>chimneys</i> and fireplaces.</p> <p>[F20, F80-OH4] Applies to floors and elements that support floors.</p> <p>[F01, F20, F80-OP1.2] Applies to masonry used in <i>chimneys</i> and fireplaces. [F20, F80-OP1.2] Applies to assemblies required to provide fire resistance.</p> <p>[F20, F80-OP2.1, OP2.4] [F20, F80-OP2.3] Applies to elements that support or are part of an environmental separator or are exposed to moisture.</p> <p>[F01-OS1.1, OS1.2] Applies to masonry used in <i>chimneys</i> and fireplaces. [F20, F80-OS1.2] Applies to assemblies required to provide fire resistance.</p>

Acceptable Solution	Objectives and Functional Statements
(1) (Cont'd)	[F20, F80-OS2.1] [F20, 80-OS2.3] Applies to elements that support or are part of an environmental separator or are exposed to moisture.
9.20.2.6.	Concrete Units Exposed to the Weather
(1)	[F61, F80-OH1.1, OH1.2, OH1.3] [F80-OH4] Applies to floors and elements that support floors. [F80-OP2.1, OP2.3] [F61-OP2.3] [F80-OP1.2] Applies to concrete blocks in <i>chimneys</i> and fireplaces. [F80-OS2.1, OS2.3] [F61-OS2.3] [F80-OS3.1] Applies to elements that support floors. [F80-OS3.4] Applies to masonry used in <i>chimneys</i> and fireplaces.
9.20.2.7.	Compressive Strength
(1)	[F20, F80-OH1.1, OH1.2, OH1.3] Applies to elements that support or are part of an environmental and to masonry used in <i>chimneys</i> and fireplaces. [F20, F80-OH4] Applies to floors and elements that support floors. [F01, F20, F80-OP1.2] Applies to masonry used in <i>chimneys</i> and fireplaces. [F20, F80-OP1.2] Applies to assemblies required to provide fire resistance. [F20, F80-OP2.1, OP2.4] [F20, F80-OP2.3] Applies to elements that support or are part of an environmental separator or are exposed to moisture. [F01-OS1.1, OS1.2] Applies to masonry used in <i>chimneys</i> and fireplaces. [F20, F80-OS1.2] Applies to assemblies required to provide fire resistance. [F20, F80-OS2.1] [F20, F80-OS2.3] Applies to elements that support or are part of an environmental separator or are exposed to moisture. [F20, F80-OS3.1] Applies to floors and elements that support floors. [F20, F80-OS3.4] Applies to masonry used in <i>chimneys</i> and fireplaces.
9.20.3.1.	Mortar Materials
(1)	[F20, F80-OH1.1, OH1.2, OH1.3] Applies to elements that support or are part of an environmental separator and to masonry used in <i>chimneys</i> and fireplaces. [F20, F80-OH4] Applies to floors and elements that support floors. [F20, F80-OS3.1] Applies to floors and elements that support floors. [F20, F80-OP2.1, OP2.4] [F20, F80-OP2.3] Applies to elements support or are part of an environmental separator. [F20, F80-OS1.2] Applies to assemblies required to provide fire resistance. [F20, F80-OS2.1] [F20, F80-OS2.3] Applies to elements that support or are part of an environmental separator.
(2)	[F20-OH1.1, OH1.2, OH1.3] Applies to elements that support or are part of an environmental separator. [F20-OH4] Applies to floors and elements that support floors. [F20-OP2.1, OP2.4] [F20-OP2.3] Applies to elements that support or are part of an environmental separator or are exposed to moisture. [F20-OS1.2] Applies to assemblies required to provide fire resistance. [F20-OS2.1] [F20-OS2.3] Applies to elements that support or are part of an environmental separator or are exposed to moisture. [F20-OS3.1] Applies to floors and elements that support floors.
(3)	[F21-OH1.1, OH1.2, OH1.3] Applies to elements that support or are part of an environmental separator and to masonry used in <i>chimneys</i> and fireplaces. [F21-OH4] Applies to floors and elements that support floors. [F21-OP2.1, OP2.4] [F21-OP2.3] Applies to elements that support or are part of an environmental separator or are exposed to moisture. [F21-OS1.2] Applies to assemblies required to provide fire resistance.

Acceptable Solution	Objectives and Functional Statements
(3) (Cont'd)	[F21-OS2.1] [F21-OS2.3] Applies to elements that support or are part of an environmental separator or are exposed to moisture. [F21-OS3.1] Applies to floors and elements that support floors.
(4)	[F21-OH1.1, OH1.2, OH1.3] Applies to elements that support or are part of an environmental separator and to masonry used in <i>chimneys</i> and fireplaces. [F21-OH4] Applies to floors and elements that support floors. [F21-OP2.1, OP2.4] [F21-OP2.3] Applies to elements that support or are part of an environmental separator or are exposed to moisture. [F21-OS1.2] Applies to assemblies required to provide fire resistance. [F21-OS2.1] [F21-OS2.3] Applies to elements that support or are part of an environmental separator or are exposed to moisture. [F21-OS3.1] Applies to floors and elements that support floors.
9.20.3.2.	Mortar and Grout Mixes
(1)	[F20, F21, F61-OH1.1, OH1.2, OH1.3] Applies to elements that support or are part of an environmental separator and to masonry used in <i>chimneys</i> and fireplaces. [F20, F21, F61-OH4] Applies to floors and elements that support floors. [F20, F21, F61-OP2.1, OP2.4] [F20, F21, F61-OP2.3] Applies to elements that support or are part of an environmental separator. [F20, F21-OS1.2] Applies to assemblies required to provide fire resistance. [F20, F21, F61-OS2.1] [F20, F21, F61-OS2.3] Applies to elements that support or are part of an environmental separator. [F20, F21, F61-OS3.1] Applies to floors and elements that support floors.
(2)	(a) [F21, F55, F61-OH1.1, OH1.2, OH1.3] (a) [F21, F55, F61-OP2.1, OP2.3] (a) [F21, F55, F61-OS2.1, OS2.3] (b) [F2-OP2.1] (b) [F21, F44-OS1.2] Applies to assemblies required to provide fire resistance. (b) [F21-OS2.1]
(3)	[F20, F21, F61-OH1.1, OH1.2, OH1.3] Applies to elements that support or are part of an environmental separator and to masonry used in <i>chimneys</i> and fireplaces. [F20, F21, F61-OH4] Applies to floors and elements that support floors. [F20, F21, F61-OP2.1, OP2.4] [F20, F21, F61-OP2.3] Applies to elements that support or are part of an environmental separator. [F20, F21-OS1.2] Applies to assemblies required to provide fire resistance. [F20, F21, F61-OS2.1] [F20, F21, F61-OS2.3] Applies to elements that support or are part of an environmental separator. [F20, F21, F61-OS3.1] Applies to floors and elements that support floors.
(4)	[F20, F21-OH1.1, OH1.2, OH1.3] Applies to elements that support or are part of an environmental separator and to masonry used in <i>chimneys</i> and fireplaces. [F20, F21-OH4] Applies to floors and elements that support floors. [F20, F21-OP2.1, OP2.4] [F20, F21-OP2.3] Applies to elements that support or are part of an environmental separator. [F20, F21-OS1.2] Applies to assemblies required to provide fire resistance. [F20, F21-OS2.1] [F20, F21-OS2.3] Applies to elements that support or are part of an environmental separator. [F20, F21-OS3.1] Applies to floors and elements that support floors.
(5)	[F20-OH1.1, OH1.2, OH1.3] Applies to elements that support or are part of an environmental separator and to masonry used in <i>chimneys</i> and fireplaces. [F20-OH4] Applies to floors and elements that support floors. [F20-OP2.1, OP2.4] [F20-OP2.3] Applies to elements that support or are part of an environmental separator. [F20-OS1.2] Applies to assemblies required to provide fire resistance.

Acceptable Solution	Objectives and Functional Statements
(5) (Cont'd)	[F20-OS2.1] [F20-OS2.3] Applies to elements that support or are part of an environmental separator. [F20-OS3.1] Applies to floors and elements that support floors.
(6)	[F20-OH1.1, OH1.2, OH1.3] Applies to elements that support or are part of an environmental separator or are part of an environmental separator and to masonry used in <i>chimneys</i> and fireplaces. [F20-OH4] Applies to floors and elements that support floors. [F20-OP2.1, OP2.4] [F20-OP2.3] Applies to elements that support or are part of an environmental separator. [F20-OS1.2] Applies to assemblies required to provide fire resistance. [F20-OS2.1] [F20-OS2.3] Applies to elements that support or are part of an environmental separator. [F20-OS3.1] Applies to floors and elements that support floors.
(7)	[F20, F21, F61-OH1.1, OH1.2, OH1.3] Applies to elements that support or are part of an environmental separator and to masonry used in <i>chimneys</i> and fireplaces. [F20, F21, F61-OH4] Applies to floors and elements that support floors. [F20, F21, F61-OP2.1, OP2.4] [F20, F21, F61-OP2.3] Applies to elements that support or are part of an environmental separator. [F20, F21, F61-OS1.2] Applies to assemblies required to provide fire resistance. [F20, F21, F61-OS2.1] [F20, F21, F61-OS2.3] Applies to elements that support or are part of an environmental separator. [F20, F21, F61-OS3.1] Applies to floors and elements that support floors.
9.20.4.1.	Thickness
(1)	[F20, F61-OH1.1, OH1.2, OH1.3] Applies to elements that support or are part of an environmental separator. [F20, F61-OH4] Applies to floors and elements that support floors. [F20, F61-OP2.1, OP2.4] [F20, F61-OP2.3] Applies to elements that support or are part of an environmental separator or are exposed to moisture. [F20, F61-OS1.2] Applies to assemblies required to provide fire resistance. [F20, F61-OS2.1] [F20, F61-OS2.3] Applies to elements that support or are part of an environmental separator or are exposed to moisture. [F20, F61-OS3.1] Applies to floors and elements that support floors.
(2)	[F20, F61-OH1.1, OH1.2, OH1.3] Applies to elements that support or are part of an environmental separator. [F20, F61-OH4] Applies to floors and elements that support floors. [F20, F61-OP2.1, OP2.4] [F20, F61-OP2.3] Applies to elements that support or are part of an environmental separator or are exposed to moisture. [F20, F61-OS1.2] Applies to assemblies required to provide fire resistance. [F20, F61-OS2.1] [F20, F61-OS2.3] Applies to elements that support or are part of an environmental separator or are exposed to moisture. [F20, F61-OS3.1] Applies to floors and elements that support floors.
9.20.4.2.	Masonry Units
(1)	[F20-OH1.1, OH1.2, OH1.3] Applies to elements that support or are part of an environmental separator and to masonry used in <i>chimneys</i> and fireplaces. [F20-OH4] Applies to floors and elements that support floors. [F20-OP2.1, OP2.4] [F20-OP2.3] Applies to elements that support or are part of an environmental separator or are exposed to moisture. [F20-OS1.2] Applies to assemblies required to provide fire resistance. [F20-OS2.1] [F20-OS2.3] Applies to elements that support or are part of an environmental separator or are exposed to moisture. [F20-OS3.1] Applies to floors and elements that support floors.

R11.1

Acceptable Solution	Objectives and Functional Statements
(2)	[F20-OH1.1, OH1.2, OH1.3] Applies to elements that support or are part of an environmental separator and to masonry used in <i>chimneys</i> and fireplaces. [F20-OH4] Applies to floors and elements that support floors. [F20-OP2.1, OP2.4] [F20-OP2.3] Applies to elements that support or are part of an environmental separator or are exposed to moisture. [F20-OS1.2] Applies to assemblies required to provide fire resistance. [F20-OS2.1] [F20-OS2.3] Applies to elements that support or are part of an environmental separator or are exposed to moisture. [F20-OS3.1] Applies to floors and elements that support floors.
(3)	[F20-OH1.1, OH1.2, OH1.3] Applies to elements that support or are part of an environmental separator and to masonry used in <i>chimneys</i> and fireplaces. [F20-OH4] Applies to floors and elements that support floors. [F20-OP2.1, OP2.4] [F20-OP2.3] Applies to elements that support or are part of an environmental separator or are exposed to moisture. [F20-OS1.2] Applies to assemblies required to provide fire resistance. [F20-OS2.1] [F20-OS2.3] Applies to elements that support or are part of an environmental separator or are exposed to moisture. [F20-OS3.1] Applies to floors and elements that support floors.
9.20.5.1.	Masonry Support
(1)	[F20, F21-OH1.1, OH1.2, OH1.3] Applies to elements that support or are part of an environmental separator. [F20, F21-OH4] Applies to floors and elements that support floors. [F20, F21-OP2.1, OP2.4] [F20, F21-OP2.3] Applies to elements that support or are part of an environmental separator or are exposed to moisture. [F20, F21-OS1.2] Applies to assemblies required to provide fire resistance. [F20, F21-OS2.1] [F20, F21-OS2.3] Applies to elements that support or are part of an environmental separator or are exposed to moisture. [F20, F21-OS3.1] Applies to floors and elements that support floors.
(2)	[F20-OH1.1, OH1.2, OH1.3] Applies to elements that support or are part of an environmental separator. [F20-OH4] Applies to floors and elements that support floors. [F20-OP2.1, OP2.4] [F20-OP2.3] Applies to elements that support or are part of an environmental separator or are exposed to moisture. [F20-OS1.2] Applies to assemblies required to provide fire resistance. [F20-OS2.1] [F20-OS2.2] Applies to elements that support or are part of an environmental separator or are exposed to moisture. [F20-OS3.1] Applies to floors and elements that support floors.
9.20.5.2.	Lintels or Arches
(1)	[F20, F22-OH1.1, OH1.2, OH1.3] Applies to elements that support or are part of an environmental separator. [F20, F22-OH4] Applies to floors and elements that support floors. [F20, F22-OP2.1, OP2.4] [F20, F22-OP2.3] Applies to elements that support or are part of an environmental separator or are exposed to moisture. [F20, F22-OS1.2] Applies to assemblies required to provide fire resistance. [F20, F22-OS2.1] [F20, F22-OS2.3] Applies to elements that support or are part of an environmental separator or are exposed to moisture. [F20, F22-OS3.1] Applies to floors and elements that support floors.
(2)	[F20, F22-OH1.1, OH1.2, OH1.3] [F20, F22-OP2.1, OP2.3, OP2.4]

Acceptable Solution	Objectives and Functional Statements
(2) (Cont'd)	[F20, F22-OS1.2] Applies to assemblies required to provide fire resistance. [F20, F22-OS2.1, OS2.3]
(3)	[F20, F22-OH1.1, OH1.2, OH1.3] [F20, F22-OP2.1, OP2.3, OP2.4] [F20, F22-OS1.2] Applies to assemblies required to provide fire resistance. [F20, F22-OS2.1, OS2.3]
(4)	[F20, F22-OH1.1, OH1.2, OH1.3] Applies to elements that support or are part of an environmental separator. [F20, F22-OP2.1, OP2.4] [F20, F22-OP2.3] Applies to elements that support or are part of an environmental separator or are exposed to moisture. [F20, F22-OS1.2] Applies to assemblies required to provide fire resistance. [F20, F22-OS2.1] [F20, F22-OS2.3] Applies to elements that support or are part of an environmental separator.
(5)	[F80-OH1.1, OH1.2, OH1.3] Applies to elements that support or are part of an environmental separator. [F80-OH4] Applies to floors and elements that support floors. [F80-OP2.1, OP2.4] [F80-OP2.3] Applies to elements that support or are part of an environmental separator or are exposed to moisture. [F20-OS1.2] Applies to assemblies required to provide fire resistance. [F80-OS2.1] [F80-OS2.3] Applies to elements that support or are part of an environmental separator or are exposed to moisture. [F80-OS3.1] Applies to floors and elements that support floors. [F80-OS3.7] Applies to walls, and elements that support walls, that contain doors or windows required for emergency egress.
(6)	[F20, F22-OH1.1, OH1.2, OH1.3] [F20, F22-OP2.1, OP2.3, OP2.4] [F20, F22-OS1.2] Applies to assemblies required to provide fire resistance. [F20, F22-OS2.1, OS2.3]
(7)	[F20, F22-OH1.1, OH1.2, OH1.3] Applies to elements that support or are part of an environmental separator. [F20, F22-OP2.1, OP2.4] [F20, F22-OP2.3] Applies to elements that support or are part of an environmental separator or are exposed to moisture. [F20, F22-OS1.2] Applies to assemblies required to provide fire resistance. [F20, F22-OS2.1] [F20, F22-OS2.3] Applies to elements that support or are part of an environmental separator.
9.20.6.1.	Thickness of Exterior Walls
(1)	[F20-OP2.1, OP2.4, OP2.5] [F22-OP2.4, OP2.5] [F20, F22-OP2.3] Applies to elements that support or are part of an environmental separator. [F20, F22-OH1.1, OH1.2, OH1.3] Applies to elements that support or are part of an environmental separator. [F20, F22-OH4] Applies to floors and elements that support floors. [F20-OS2.1, OS2.5] [F22-OS2.5] [F20, F22-OS2.3] Applies to elements that support or are part of an environmental separator. [F20, F22-OS3.1] Applies to floors and elements that support floors.
(2)	[F20-OP2.1, OP2.4, OP2.5] [F22-OP2.4, OP2.5] [F20, F22-OP2.3] Applies to elements that support or are part of an environmental separator. [F20, F22-OH1.1, OH1.2, OH1.3] Applies to elements that support or are part of an environmental separator. [F20, F22-OH4] Applies to floors and elements that support floors. [F20-OS2.1, OS2.5] [F22-OS2.5] [F20, F22-OS2.3] Applies to elements that support or are part of an environmental separator. [F20, F22-OS3.1] Applies to floors and elements that support floors.

Acceptable Solution	Objectives and Functional Statements
(3)	[F20-OP2.1, OP2.4, OP2.5] [F22-OP2.4, OP2.5] [F20, F22-OP2.3] Applies to elements that support are or part of an environmental separator. [F20, F22-OH1.1, OH1.2, OH1.3] Applies to elements that support or are part of an environmental separator. [F20, F22-OH4] Applies to floors and elements that support floors. [F20, F22-OS1.2] Applies to assemblies required to provide fire resistance. [F20-OS2.1, OS2.5] [F22-OS2.5] [F20, F22-OS2.3] Applies to elements that support or are part of an environmental separator. [F20, F22-OS3.1] Applies to floors and elements that support floors.
9.20.6.2.	Cavity Walls
(1)	[F20-OP2.1, OP2.4, OP2.5] [F22-OP2.4, OP2.5] [F20, F22-OP2.3] Applies to elements that support or are part of an environmental separator or are exposed to moisture. [F20, F22-OH1.1, OH1.2, OH1.3] Applies to elements that support or are part of an environmental separator. [F20, F22-OH4] Applies to floors and elements that support floors. [F20, F22-OS1.2] Applies to assemblies required to provide fire resistance. [F20-OS2.1, OS2.5] [F22-OS2.5] [F20, F22-OS2.3] Applies to elements that support or are part of an environmental separator or are exposed to moisture. [F20, F22-OS3.1] Applies to floors and elements that support floors.
(2)	[F20-OP2.1, OP2.4, OP2.5] [F22-OP2.4, OP2.5] [F20, F22, F61-OP2.3] Applies to elements that support or are part of an environmental separator. [F61-OS1.2] Applies to assemblies required to provide fire resistance. [F20-OS2.1, OS2.5] [F22-OS2.5] [F20, F22, F61-OS2.3] Applies to elements that support or are part of an environmental separator. [F20, F22-OS3.1] Applies to floors and elements that support floors [F20, F22, F61-OH1.1, OH1.2, OH1.3] Applies to elements that support or are part of an environmental separator. [F20, F22-OH4] Applies to floors and elements that support floors.
(3)	[F20-OP2.1, OP2.4, OP2.5] [F22-OP2.4, OP2.5] [F20, F22-OP2.3] Applies to elements that support or are part of an environmental separator. [F20-OS2.1, OS2.5] [F22-OS2.5] [F20, F22-OS2.3] Applies to elements that support or are part of an environmental separator or are exposed to moisture [F20, F22-OS3.1] Applies to floors and elements that support floors. [F20, F22-OH1.1, OH1.2, OH1.3] Applies to elements that support or are part of an environmental separator. [F20, F22-OH4] Applies to floors and elements that support floors.
9.20.6.3.	Thickness of Interior Walls
(1)	
(2)	(b) [F20-OP2.1, OP2.3, OP2.5] [F22-OP2.5]
	(b) [F20-OS2.1, OS2.3, OS2.5] [F22-OS2.5]
9.20.6.4.	Masonry Veneer
(1)	[F20-OP2.1, OP2.5] [F22-OP2.5] [F20, F22-OP2.3] Applies to elements that are part of an environmental separator. [F20, F22-OH1.1, OH1.2, OH1.3] Applies to elements that are part of an environmental separator. [F20, F22-OS1.2] Applies to assemblies required to provide fire resistance. [F20-OS2.1, OS2.5] [F22-OS2.5] [F20, F22-OS2.3] Applies to elements that are part of an environmental separator.

Acceptable Solution	Objectives and Functional Statements	
(2)	[F61-OH1.1, OH1.2, OH1.3] [F61-OP2.3] [F61-OS1.2] Applies to assemblies required to provide fire resistance. [F61-OS2.3]	
(3)	[F20-OP2.1, OP2.3, OP2.5] [F22-OP2.3, OP2.5] [F20, F22-OH1.1, OH1.2, OH1.3] [F20, F22-OS1.2] Applies to assemblies required to provide fire resistance. [F20-OS2.1, OS2.3, OS2.5] [F22-OS2.3, OS2.5]	
(4)		
9.20.6.5.	Parapet Walls	
(1)	[F20-OP2.1, OP2.3, OP2.5] [F22-OP2.5] [F20-OS2.1, OP2.3, OP2.5] [F22-OS2.5] [F20, F22-OH1.1, OH1.2, OH1.3]	
(2)	[F61-OH1.1, OH1.2, OH1.3] [F61-OP2.3] [F61-OS1.2] [F61-OS2.3]	
R11.1	(3)	[F61-OH1.1, OH1.2, OH1.3] [F61-OP2.3] [F61-OS1.2] [F61-OS2.3]
9.20.6.6.	Stone or Concrete Facings	
(1)		
9.20.7.1.	Maximum Dimensions	
(1)	[F20-OP2.1, OP2.4, OP2.5] [F22-OP2.4, OP2.5] [F20, F22-OP2.3] Applies to elements that support or are part of an environmental separator. [F20, F22-OH1.1, OH1.2, OH1.3] Applies to elements that support or are part of an environmental separator. [F20, F22-OH4] Applies to floors and elements that support floors. [F20, F22-OS1.2] Applies to assemblies required to provide fire resistance. [F20-OS2.1, OS2.5] [F22-OS2.5] [F20, F22-OS2.3] Applies to elements that support or are part of an environmental separator. [F20, F22-OS3.1] Applies to floors and elements that support floors.	
9.20.7.2.	Minimum Wall Thickness	
(1)	[F20-OP2.1, OP2.4, OP2.5] [F22-OP2.4, OP2.5] [F20, F22-OP2.3] Applies to elements that support or are part of an environmental separator. [F20, F22-OH1.1, OH1.2, OH1.3] Applies to elements that support or are part of an environmental separator. [F20, F22-OH4] Applies to floors and elements that support floors. [F20, F22-OS1.2] Applies to assemblies required to provide fire resistance. [F20-OS2.1, OS2.5] [F22-OS2.5] [F20, F22-OS2.3] Applies to elements that support or are part of an environmental separator. [F20, F22-OS3.1] Applies to floors and elements that support floors.	
(2)	[F20-OP2.1, OP2.4, OP2.5] [F22-OP2.4, OP2.5] [F20, F22-OP2.3] Applies to elements that support or are part of an environmental separator. [F20, F22-OH1.1, OH1.2, OH1.3] Applies to elements that support or are part of an environmental separator. [F20, F22-OH4] Applies to floors and elements that support floors. [F20, F22-OS1.2] Applies to assemblies required to provide fire resistance. [F20-OS2.1, OS2.5] [F22-OS2.5] [F20, F22-OS2.3] Applies to elements that support or are a part of an environmental separator. [F20, F22-OS3.1] Applies to floors and elements that support floors.	

Acceptable Solution	Objectives and Functional Statements
9.20.7.3.	Separation of Chases and Recesses
(1)	[F20-OP2.1, OP2.4, OP2.5] [F22-OP2.4, OP2.5] [F20, F22-OP2.3] Applies to elements that support or are part of an environmental separator. [F20, F22-OH1.1, OH1.2, OH1.3] Applies to elements that support or are part of an environmental separator. [F20, F22-OH4] Applies to floors and elements that support floors. [F20, F22-OS1.2] Applies to assemblies required to provide fire resistance. [F20-OS2.1, OS2.5] [F22-OS2.5] [F20, F22-OS2.3] Applies to elements that support or are part of an environmental separator. [F20, F22-OS3.1] Applies to floors and elements that support floors.
9.20.7.4.	Non-Conforming Chases or Recesses
(1)	[F20-OP2.1, OP2.4, OP2.5] [F22-OP2.4, OP2.5] [F20, F22-OP2.3] Applies to elements that support or are part of an environmental separator. [F20, F22-OH1.1, OH1.2, OH1.3] Applies to elements that support or are part of an environmental separator. [F20, F22-OH4] Applies to floors and elements that support floors. [F20, F22-OS1.2] Applies to assemblies required to provide fire resistance. [F20-OS2.1, OS2.5] [F22-OS2.5] [F20, F22-OS2.3] Applies to elements that support or are part of an environmental separator. [F20, F22-OS3.1] Applies to floors and elements that support floors.
9.20.7.5.	Chases or Recesses Cut into Walls
(1)	[F20-OH1.1, OH1.2, OH1.3] Applies to elements that support or are part of an environmental separator. [F20-OH4] Applies to floors and elements that support floors. [F20-OP2.1, OP2.4] [F20-OP2.3] Applies to elements that support or are part of an environmental separator. [F20-OS1.2] Applies to assemblies required to provide fire resistance. [F20-OS2.1] [F20-OS2.3] Applies to elements that support or are part of an environmental separator. [F20-OS3.1] Applies to floors and elements that support floors.
9.20.8.1.	Capping of Hollow Masonry Walls
(1)	[F20-OH1.1, OH1.2, OH1.3] Applies to elements that support or are part of an environmental separator. [F20-OH4] Applies to floors and elements that support floors. [F20-OP2.1, OP2.4] [F20-OP2.3] Applies to elements that support or are part of an environmental separator. [F20-OS1.2] Applies to assemblies required to provide fire resistance. [F20-OS2.1] [F20-OS2.3] Applies to elements that support or are part of an environmental separator. [F20-OS3.1] Applies to floors and elements that support floors.
(2)	[F20-OH1.1, OH1.2, OH1.3] Applies to elements that support or are part of an environmental separator. [F20-OH4] Applies to floors and elements that support floors. [F20-OP2.1, OP2.4] [F20-OP2.3] Applies to elements that support or are part of an environmental separator. [F20-OS2.1] [F20-OS2.3] Applies to elements that support or are part of an environmental separator. [F20-OS3.1] Applies to floors and elements that support floors.
9.20.8.2.	Cavity Walls Supporting Framing Members
(1)	[F20-OH1.1, OH1.2, OH1.3] Applies to elements that support or are part of an environmental separator. [F20-OH4] Applies to floors and elements that support floors. [F20-OP2.1, OP2.4] [F20-OP2.3] Applies to elements that support or are part of an environmental separator. [F20-OS1.2] Applies to assemblies required to provide fire resistance.

Acceptable Solution	Objectives and Functional Statements
(1) (Cont'd)	[F20-OS2.1] [F20-OS2.3] Applies to elements that support or are part of an environmental separator. [F20-OS3.1] Applies to floors and elements that support floors.
(2)	[F80-OP2.3] [F80-OS2.3]
(3)	[F20-OH1.1, OH1.2, OH1.3] Applies to elements that support or are part of an environmental separator. [F20-OH4] Applies to floors and elements that support floors. [F20-OP2.1, OP2.4] [F20-OP2.3] Applies to elements that support or are part of an environmental separator. [F20-OS1.2] Applies to assemblies required to provide fire resistance. [F20-OS2.1] [F20-OS2.3] Applies to elements that support or are part of an environmental separator. [F20-OS3.1] Applies to floors and elements that support floors.
9.20.8.3.	Bearing of Beams and Joists
(1)	[F20-OP2.1] [F20-OP2.3] Applies to elements that support or are part of an environmental separator. [F20-OS2.1] [F20-OS2.3] Applies to elements that support or are part of an environmental separator.
(2)	[F20-OP2.1] [F20-OP2.3] Applies to elements that support or are part of an environmental separator. [F20-OS2.1] [F20-OS2.3] Applies to elements that support or are part of an environmental separator.
(3)	[F20-OP2.1] [F20-OP2.3] Applies to elements that support or are part of an environmental separator. [F20-OS2.1] [F20-OS2.3] Applies to elements that support or are part of an environmental separator.
9.20.8.4.	Support of Beams and Columns
(1)	[F20-OP2.1, OP2.4, OP2.5] [F22-OP2.4, OP2.5] [F20, F22-OP2.3] Applies to elements that support or are part of an environmental separator. [F20, F22-OH1.1, OH1.2, OH1.3] Applies to elements that support or are part of an environmental separator. [F20, F22-OH4] Applies to floors and elements that support floors. [F20, F22-OS1.2] Applies to assemblies required to provide fire resistance. [F20-OS2.1, OS2.5] [F22-OS2.5] [F20, F22-OS2.3] Applies to elements that support or are part of an environmental separator. [F20, F22-OS3.1] Applies to floors and elements that support floors.
(2)	[F20-OH1.1, OH1.2, OH1.3] Applies to elements that support or are part of an environmental separator. [F20-OH4] Applies to floors and elements that support floors. [F20-OP2.1, OP2.2] [F20-OP2.3] Applies to elements that support or are part of an environmental separator. [F20-OS1.2] Applies to assemblies required to provide fire resistance. [F20-OS2.1] [F20-OS2.3] Applies to elements that support or are part of an environmental separator. [F20-OS3.1] Applies to floors and elements that support floors.
(3)	[F20-OP2.1, OP2.4, OP2.5] [F22-OP2.4, OP2.5] [F20, F22-OP2.3] Applies to elements that support or are part of an environmental separator. [F20, F22-OH1.1, OH1.2, OH1.3] Applies to elements that support or are part of an environmental separator. [F20, F22-OH4] Applies to floors and elements that support floors. [F20, F22-OS1.2] Applies to assemblies required to provide fire resistance. [F20-OS2.1, OS2.5] [F22-OS2.5] [F20, F22-OS2.3] Applies to elements that support or are part of an environmental separator. [F20, F22-OS3.1] Applies to floors and elements that support floors.

Acceptable Solution	Objectives and Functional Statements
(4)	[F20-OP2.1, OP2.4, OP2.5] [F22-OP2.4, OP2.5] [F20, F22-OP2.3] Applies to elements that support or are part of an environmental separator. [F20, F22-OH1.1, OH1.2, OH1.3] Applies to elements that support or are part of an environmental separator. [F20, F22-OH4] Applies to floors and elements that support floors. [F20, F22-OS1.2] Applies to assemblies required to provide fire resistance. [F20-OS2.1, OS2.5] [F22-OS2.5] [F20, F22-OS2.3] Applies to elements that support or are part of an environmental separator. [F20, F22-OS3.1] Applies to floors and elements that support floors.
(5)	[F20-OP2.1, OP2.4, OP2.5] [F22-OP2.4, OP2.5] [F20, F22-OP2.3] Applies to elements that support or are part of an environmental separator. [F20, F22-OH1.1, OH1.2, OH1.3] Applies to elements that support or are part of an environmental separator. [F20, F22-OH4] Applies to floors and elements that support floors. [F20, F22-OS1.2] Applies to assemblies required to provide fire resistance. [F20-OS2.1, OS2.4, OS2.5] [F22-OS2.4, OS2.5] [F20, F22-OS2.3] Applies to elements that support or are part of an environmental separator. [F20, F22-OS3.1] Applies to floors and elements that support floors.
9.20.8.5.	Projection of Masonry Veneer Beyond Supporting Members
(1)	[F20-OP2.1, OP2.4, OP2.5] [F22-OP2.4, OP2.5] [F20, F22-OP2.3] Applies to elements that support or are part of an environmental separator. [F20, F22-OH1.1, OH1.2, OH1.3] Applies to elements that support or are part of an environmental separator. [F20, F22-OS1.2] Applies to assemblies required to provide fire resistance. [F20-OS2.1, OS2.5] [F22-OS2.5] [F20, F22-OS2.3] Applies to elements that support or are part of an environmental separator.
(2)	
9.20.9.1.	Joints to be Offset or Reinforced
(1)	[F20-OH1.1, OH1.2, OH1.3] Applies to elements that support or are part of an environmental separator. [F20-OH4] Applies to floors and elements that support floors. [F20-OP2.1, OP2.4] [F20-OP2.3] Applies to elements that support or are part of an environmental separator. [F20-OS1.2] Applies to assemblies required to provide fire resistance. [F20-OS2.1] [F20-OS2.3] Applies to elements that support or are part of an environmental separator. [F20-OS3.1] Applies to floors and elements that support floors.
(2)	[F20-OH1.1, OH1.2, OH1.3] Applies to elements that support or are part of an environmental separator. [F20-OH4] Applies to floors and elements that support floors. [F20-OP2.1, OP2.4] [F20-OP2.3] Applies to elements that support or are part of an environmental separator. [F20-OS1.2] Applies to assemblies required to provide fire resistance. [F20-OS2.1] [F20-OS2.3] Applies to elements that support or are part of an environmental separator. [F20-OS3.1] Applies to floors and elements that support floors.

Acceptable Solution	Objectives and Functional Statements
9.20.9.2.	Bonding or Tying of Other than Masonry Veneer
(1)	[F20-OP2.1, OP2.5] [F22-OP2.4, OP2.5] [F20, F22-OP2.3] Applies to elements that support or are part of an environmental separator. [F20, F22-OH1.1, OH1.2, OH1.3] Applies to elements that support or are part of an environmental separator. [F20, F22-OH4] Applies to floors and elements that support floors. [F20, F22-OS1.2] Applies to assemblies required to provide fire resistance. [F20-OS2.1, OS2.5] [F22-OS2.5] [F20, F22-OS2.3] Applies to elements that support or are part of an environmental separator. [F20, F22-OS3.1] Applies to floors and elements that support floors. [F20, F22-OS3.7] Applies to walls, and elements that support walls, that contains doors or windows required for emergency egress.
9.20.9.3.	Bonding
(1)	[F20-OH1.1, OH1.2, OH1.3] Applies to elements that support or are part of an environmental separator. [F20-OH4] Applies to floors and elements that support floors. [F20-OP2.1, OP2.4] [F20-OP2.3] Applies to elements that support or are part of an environmental separator. [F20-OS1.2] Applies to assemblies required to provide fire resistance. [F20-OS2.1] [F20-OS2.3] Applies to elements that support or are part of an environmental separator. [F20-OS3.1] Applies to floors and elements that support floors.
(2)	[F20-OH1.1, OH1.2, OH1.3] Applies to elements that support or are part of an environmental separator. [F20-OH4] Applies to floors and elements that support floors. [F20-OP2.1, OP2.4] [F20-OP2.3] Applies to elements that support or are part of an environmental separator. [F20-OS1.2] Applies to assemblies required to provide fire resistance. [F20-OS2.1] [F20-OS2.3] Applies to elements that support or are part of an environmental separator. [F20-OS3.1] Applies to floors and elements that support floors.
(3)	[F20-OH1.1, OH1.2, OH1.3] Applies to elements that support or are part of an environmental separator. [F20-OH4] Applies to floors and elements that support floors. [F20-OP2.1, OP2.4] [F20-OP2.3] Applies to elements that support or are part of an environmental separator. [F20-OS1.2] Applies to assemblies required to provide fire resistance. [F20-OS2.1] [F20-OS2.3] Applies to elements that support or are part of an environmental separator. [F20-OS3.1] Applies to floors and elements that support floors.
9.20.9.4.	Tying
(1)	
(2)	[F20, F80-OH1.1, OH1.2, OH1.3] Applies to elements that support or are part of an environmental separator. [F20, F80-OH4] Applies to floors and elements that support floors. [F20, F80-OP2.1, OP2.4] [F20, F80-OP2.3] Applies to elements that support or are part of an environmental separator. [F20, F80-OS1.2] Applies to assemblies required to provide fire resistance. [F20, F80-OS2.1] [F20, F80-OS2.3] Applies to elements that support or are part of an environmental separator. [F20, F80-OS3.1] Applies to floors and elements that support floors. [F20, F80-OS3.7] Applies to walls, and elements that support walls, that contain doors or windows required for emergency egress.
(3)	[F20, F80-OH1.1, OH1.2, OH1.3] Applies to elements that support or are part of an environmental separator. [F20, F80-OH4] Applies to floors and elements that support floors. [F20, F80-OP2.1, OP2.4] [F20, F80-OP2.3] Applies to elements that support or are part of an environmental separator.

Acceptable Solution	Objectives and Functional Statements
(3) (Cont'd)	[F20, F80-OS1.2] Applies to assemblies required to provide fire resistance. [F20, F80-OS2.1] [F20, F80-OS2.3] Applies to elements that support or are part of an environmental separator. [F20, F80-OS3.1] Applies to floors and elements that support floors. [F20, F80-OS3.7] Applies to walls, and elements that support walls, that contain doors or windows for emergency egress.
(4)	[F20, F80-OH1.1, OH1.2, OH1.3] Applies to elements that support or are part of an environmental separator. [F20, F80-OH4] Applies to floors and elements that support floors. [F20, F80-OP2.1, OP2.4] [F20, F80-OP2.3] Applies to elements that support or are part of an environmental separator. [F20, F80-OS1.2] Applies to assemblies required to provide fire resistance. [F20, F80-OS2.1] [F20, F80-OS2.3] Applies to elements that support or are part of an environmental separator. [F20, F80-OS3.7] Applies to floors and elements that support floors. [F20, F80-OS3.7] Applies to walls, and elements that support walls, that contain doors and windows required for emergency egress.
(5)	[F20-OH1.1, OH1.2, OH1.3] Applies to elements that support or are part of an environmental separator. [F20-OH4] Applies to floors and elements that support floors. [F20-OP2.1, OP2.4] [F20-OP2.3] Applies to elements that support or are part of an environmental separator. [F20-OS1.2] Applies to assemblies required to provide fire resistance. [F20-OS2.1] [F20-OS2.3] Applies to elements that support or are part of an environmental separator. [F20-OS3.1] Applies to floors and elements that support floors.
(6)	[F20-OH1.1, OH1.2, OH1.3] Applies to elements that support or are part of an environmental separator. [F20-OH4] Applies to floors and elements that support floors. [F20-OP2.1, OP2.4] [F20-OP2.3] Applies to elements that support or are part of an environmental separator. [F20-OS1.2] Applies to assemblies required to provide fire resistance. [F20-OS2.1] [F20-OS2.3] Applies to elements that support or are part of an environmental separator. [F20-OS3.1] Applies to floors and elements that support floors.
(7)	[F20-OH1.1, OH1.2, OH1.3] Applies to elements that support or are part of an environmental separator. [F20-OH4] Applies to floors and elements that support floors. [F20-OP2.1, OP2.4] [F20-OP2.3] Applies to elements that support or are part of an environmental separator. [F20-OS1.2] Applies to assemblies required to provide fire resistance. [F20-OS2.1] [F20-OS2.3] Applies to elements that support or are part of an environmental separator. [F20-OS3.1] Applies to floors and elements that support floors.
(8)	[F20-OH1.1, OH1.2, OH1.3] Applies to elements that support or are part of an environmental separator. [F20-OH4] Applies to floors and elements that support floors. [F20-OP2.1, OP2.4] [F20-OP2.3] Applies to elements that support or are part of an environmental separator. [F20-OS1.2] Applies to assemblies required to provide fire resistance. [F20-OS2.1] [F20-OS2.3] Applies to elements that support or are part of an environmental separator. [F20-OS3.1] Applies to floors and elements that support floors.
(9)	[F20-OH1.1, OH1.2, OH1.3] Applies to elements that support or are part of an environmental separator. [F20-OH4] Applies to floors and elements that support floors. [F20-OP2.1, OP2.4] [F20-OP2.3] Applies to elements that support or are part of an environmental separator. [F20-OS1.2] Applies to assemblies required to provide fire resistance.

Acceptable Solution	Objectives and Functional Statements
(9) (Cont'd)	[F20-OS2.1] [F20-OS2.3] Applies to elements that support or are part of an environmental separator. [F20-OS3.1] Applies to floors and elements that support floors.
9.20.9.5.	Ties for Masonry Veneer
(1)	[F20, F22, F80-OH1.1, OH1.2, OH1.3] Applies to elements that support or are part of an environmental separator. [F20, F22, F80-OS1.2] Applies to assemblies required to provide fire resistance. [F20, F80-OP2.1] [F20, F22, F80-OP2.5] [F20, F22, F80-OP2.3] Applies to elements that support or are part of an environmental separator. [F20, F80-OS2.1] [F20, F22, F80-OS2.5] [F20, F22, F80-OS2.3] Applies to elements that support or are part of an environmental separator.
(2)	[F20, F80-OH1.1, OH1.2, OH1.3] Applies to elements that support or are part of an environmental separator. [F20, F80-OP2.1] [F20, F80-OP2.3] Applies to elements that support or are part of an environmental separator. [F20, F80-OS1.2] Applies to assemblies required to provide fire resistance. [F20, F80-OS2.1] [F20, F80-OS2.3] Applies to elements that support or are part of an environmental separator.
(3)	
(4)	[F20, F22, F80-OH1.1, OH1.2, OH1.3] Applies to elements that support or are part of an environmental separator. [F20, F22, F80-OS1.2] Applies to assemblies required to provide fire resistance. [F20, F80-OP2.1] [F20, F22, F80-OP2.5] [F20, F22, F80-OP2.3] Applies to elements that support or are part of an environmental separator. [F20, F80-OS2.1] [F20, F22, F80-OS2.5] [F20, F22, F80-OS2.3] Applies to elements that support or are part of an environmental separator.
9.20.9.6.	Reinforcing for Glass Block
(1)	[F20-OH1.1, OH1.2, OH1.3] Applies to elements that are part of an environmental separator. [F20-OP2.1] [F20-OP2.3] Applies to elements that are part of an environmental separator. [F20-OS1.2] Applies to assemblies required to provide fire resistance. [F20-OS2.1] [F20-OS2.3] Applies to elements that are part of an environmental separator.
(2)	[F20-OH1.1, OH1.2, OH1.3] Applies to elements that are part of an environmental separator. [F20-OP2.1] [F20-OP2.3] Applies to elements that are part of an environmental separator. [F20-OS1.2] Applies to assemblies required to provide fire resistance. [F20-OS2.1] [F20-OS2.3] Applies to elements that are part of an environmental separator.
9.20.10.1.	Lateral Support Required
(1)	[F20-OP2.1] [F20, F22-OP2.4, OP2.5] [F20, F22-OP2.3] Applies to elements that support or are part of an environmental separator. [F20, F22-OH1.1, OH1.2, OH1.3] Applies to elements that support or are part of an environmental separator. [F20, F22-OH4] Applies to floors and elements that support floors. [F20, F22-OS1.2] Applies to assemblies required to provide fire resistance. [F20-OS2.1] [F20, F22-OS2.5] [F20, F22-OS2.3] Applies to elements that support or are part of an environmental separator. [F20, F22-OS3.1] Applies to floors and elements that support floors.
(2)	[F20-OP2.1, OP2.4] [F20, F22-OP2.5] [F20, F22-OS1.2] Applies to assemblies required to provide fire resistance. [F20-OS2.1] [F20, F22-OS2.5]

Acceptable Solution	Objectives and Functional Statements
(2) (Cont'd)	(a) [F20, F22-OH1.1, OH1.2, OH1.3] Applies to elements that support or are part of an environmental separator. (a) [F20, F22-OH4] Applies to floors and elements that support floors. (a) [F20, F22-OP2.3] Applies to elements that support or are part of an environmental separator. (a) [F20, F22-OS2.3] Applies to elements that support or are part of an environmental separator. (a) [F20, F22-OS3.1] Applies to floors and elements that support floors.
(3)	
(4)	[F20-OP2.1] [F20, F22-OP2.4, OP2.5] [F20, F22-OP2.3] Applies to elements that support or are part of an environmental separator or are exposed to moisture. [F20, F22-OH1.1, OH1.2, OH1.3] Applies to elements that support or are part of an environmental separator. [F20, F22-OH4] Applies to floors and elements that support fire resistance. [F20, F22-OS1.2] Applies to assemblies required to provide fire resistance. [F20-OS2.1] [F20, F22-OS2.5] [F20, F22-OS2.3] Applies to elements that support or are part of an environmental separator or are exposed to moisture. [F20, F22-OS3.1] Applies to floors and elements that support floors.
9.20.11.1.	Anchorage of Floor or Roof Assemblies
(1)	[F20-OP2.1] [F20, F22-OP2.4, OP2.5] [F20, F22-OP2.3] Applies to elements that support or are part of an environmental separator. [F20, F22-OH1.1, OH1.2, OH1.3] Applies to elements that support or are part of an environmental separator. [F20, F22-OH4] Applies to floors and elements that support floors. [F20, F22-OS1.2] Applies to assemblies required to provide fire resistance. [F20-OS2.1] [F20, F22-OS2.5] [F20, F22-OS2.3] Applies to elements that support or are part of an environmental separator. [F20, F22-OS3.1] Applies to floors and elements that support floors.
(2)	[F20, F80-OH1.1, OH1.2, OH1.3] Applies to elements that support or are part of an environmental separator. [F20, F80-OH4] Applies to floors and elements that support floors. [F20, F80-OP2.3] Applies to elements that support or are part of an environmental separator or are exposed to moisture. [F20, F80-OS1.2] Applies to assemblies required to provide fire resistance. [F20, F80-OS2.1] [F20, F80-OS2.3] Applies to elements that support are part of an environmental separator. [F20, F80-OS3.1] Applies to floors and elements that support walls. [F20, F80-OS3.7] Applies to walls, and elements that support walls, that contain doors or windows required for emergency egress.
(3)	[F20-OH1.1, OH1.2, OH1.3] Applies to elements that support or are part of an environmental separator. [F20-OH4] Applies to floors and elements that support floors. [F20-OP2.1, OP2.4] [F20-OP2.3] Applies to elements that support or are part of an environmental separator or are exposed to moisture. [F20-OS1.2] Applies to assemblies required to provide fire resistance. [F20-OS2.1] [F20-OS2.3] Applies to elements that support or are part of an environmental separator. [F20-OS3.1] Applies to floors and elements that support floors.
(4)	[F20-OP2.1] [F20, F22-OP2.4, OP2.5] [F20, F22-OP2.3] Applies to elements that support or are part of an environmental separator or are exposed to moisture. [F20, F22-OH1.1, OH1.2, OH1.3] Applies to elements that support or are part of an environmental separator. [F20, F22-OH4] Applies to floors and elements that support floors. [F20, F22-OS1.2] Applies to assemblies required to provide fire resistance.

Acceptable Solution	Objectives and Functional Statements
(4) (Cont'd)	[F20-OS2.1] [F20, F22-OS2.5] [F20, F22-OS2.3] Applies to elements that support or are part of an environmental separator. [F20, F22-OS3.1] Applies to floors and elements that support floors.
9.20.11.2.	Bonding and Tying of Intersecting Walls
(1)	[F20-OP2.1] [F20, F22-OP2.4, OP2.5] [F20, F22-OP2.3] Applies to elements that support or are part of an environmental separator or are exposed to moisture. [F20, F22-OH1.1, OH1.2, OH1.3] Applies to elements that support or are part of an environmental separator. [F20, F22-OH4] Applies to floors and elements that support floors. [F20, F22-OS1.2] Applies to assemblies required to provide fire resistance. [F20-OS2.1] [F20, F22-OS2.5] [F20, F22-OS2.3] Applies to elements that support or are part of an environmental separator. [F20, F22-OS3.1] Applies to floors and elements that support floors.
(2)	[F20-OH1.1, OH1.2, OH1.3] Applies to elements that support or are part of an environmental separator. [F20-OH4] Applies to floors and elements that support floors [F20-OP2.1, OP2.4] [F20-OP2.3] Applies to elements that support or are part of an environmental separator. [F20-OS2.1] [F20-OS2.3] Applies to elements that support or are part of an environmental separator. [F20-OS3.1] Applies to floors and elements that support floors.
(3)	[F20, F80-OH1.1, OH1.2, OH1.3] Applies to elements that support floors or are part of an environmental separator. [F20, F80-OH4] Applies to floors and elements that support floors. [F20, F80-OP2.1, OP2.4] [F20, F80-OP2.3] Applies to elements that support or are part of an environmental separator. [F20, F80-OS1.2] Applies to assemblies required to provide fire resistance. [F20, F80-OS2.1] [F20, F80-OS2.3] Applies to elements that support or are part of an environmental separator. [F20, F80-OS3.1] Applies to floors and elements that support floors. [F20, F80-OS3.7] Applies to walls, and elements that support walls, that contain doors or windows required for emergency egress.
9.20.11.3.	Wood Frame Walls Intersecting Masonry Walls
(1)	[F20, F22, F80-OH1.1, OH1.2, OH1.3] Applies to elements that support or are part of an environmental separator. [F20, F22, F80-OH4] Applies to floors and elements that support floors. [F20, F22, F80-OS1.2] Applies to assemblies to provide fire resistance. [F20, F80-OS2.1] [F20, F22, F80-OS2.5] [F20, F22, F80-OS2.3] Applies to elements that support or are part of an environmental separator. [F20, F22, F80-OS3.1] Applies to floors and elements that support floors. [F20, F22, F80-OS3.7] Applies to walls, and elements that support walls, that contain doors or windows required for emergency egress. [F20, F80-OP2.1] [F20, F22, F80-OP2.4, OP2.5] [F20, F22, F80-OP2.3] Applies to elements that support or are part of an environmental separator.
(2)	[F20-OH1.1, OH1.2, OH1.3] Applies to elements that support or are part of an environmental separator. [F20-OH4] Applies to floors and elements that support floors. [F20-OP2.1, OP2.4] [F20-OP2.3] Applies to elements that support or are part of an environmental separator. [F20-OS1.2] Applies to assemblies required to provide fire resistance. [F20-OS2.1] [F20-OS2.3] Applies to elements that support or are part of an environmental separator. [F20-OS3.1] Applies to floors and elements that support floors.

Acceptable Solution	Objectives and Functional Statements
9.20.11.4.	Wood Frame Roof Systems
(1)	[F20-OH1.1, OH1.2, OH1.3] [F20-OP2.1, OP2.3] [F20-OS2.1, OS2.3]
(2)	[F20-OH1.1, OH1.2, OH1.3] [F20-OP2.1, OP2.3] [F20-OS2.1, OS2.3]
9.20.11.5.	Cornices, Sills and Trim
(1)	[F20, F80-OS2.1, OS2.3, OS2.5] [F22-OS2.5]
9.20.11.6.	Piers
(1)	[F20-OH1.1, OH1.2, OH1.3] Applies to elements that support or are part of an environmental separator. [F20-OH4] Applies to floors and elements that support floors. [F20-OP2.1] [F20-OP2.3] Applies to elements that support or are part of an environmental separator. [F20-OS1.2] Applies to assemblies required to provide fire resistance. [F20-OS2.1] [F20-OS2.3] Applies to elements that support or are part of an environmental separator. [F20-OS3.1] Applies to floors and elements that support floors.
9.20.12.1.	Corbelling
(1)	[F20-OH1.1, OH1.2, OH1.3] Applies to elements that support or are part of an environmental separator. [F20-OH4] Applies to floors and elements that support floors. [F20-OP2.1] [F20-OP2.3] Applies to elements that support or are part of an environmental separator. [F20-OS1.2] Applies to assemblies required to provide fire resistance. [F20-OS2.1] [F20-OS2.3] Applies to elements that support or are part of an environmental separator. [F20-OS3.1] Applies to floors and elements that support floors.
(2)	[F20-OH1.1, OH1.2, OH1.3] Applies to elements that support or are part of an environmental separator. [F20-OH4] Applies to floors and elements that support floors. [F20-OP2.1, OP2.4] [F20-OP2.3] Applies to elements that support or are part of an environmental separator. [F20-OS1.2] Applies to assemblies required to provide fire resistance. [F20-OS2.1] [F20-OS2.3] Applies to elements that support or are part of an environmental separator.
9.20.12.2.	Corbelling for Cavity Walls
(1)	[F20-OH1.1, OH1.2, OH1.3] Applies to elements that support or are part of an environmental separator. [F20-OH4] Applies to floors and elements that support floors. [F20-OP2.1, OP2.4] [F20-OP2.3] Applies to elements that support or are part of environmental separator. [F20-OS2.1] [F20-OS2.3] Applies to elements that support or are part of an environmental separator. [F20-OS3.1] Applies to floors and elements that support floors.
(2)	[F20-OH1.1, OH1.2, OH1.3] Applies to elements that support or are part of an environmental separator. [F20-OH4] Applies to floors and elements that support floors. [F20-OP2.1, OP2.4] [F20-OP2.3] Applies to elements that support or are part of an environmental separator. [F20-OS2.1] [F20-OS2.3] Applies to elements that support or are part of an environmental separator. [F20-OS3.1] Applies to floors and elements that support floors.
9.20.12.3.	Corbelling for Masonry Veneer
(1)	[F20-OH1.1, OH1.2, OH1.3] Applies to elements that support or are part of an environmental separator. [F20-OP2.1] [F20-OP2.3] Applies to elements that support or are part of an environmental separator.

Acceptable Solution	Objectives and Functional Statements
(1) (Cont'd)	[F20-OS2.1] [F20-OS2.3] Applies to elements that support or are part of an environmental separator.
(2)	[F20-OH1.1, OH1.2, OH1.3] Applies to elements that support or are part of an environmental separator.
	[F20-OP2.1] [F20-OP2.3] Applies to elements that support or are part of an environmental separator.
	[F20-OS2.1] [F20-OS2.3] Applies to elements that support or are part of an environmental separator.
9.20.13.1.	Materials for Flashing
(1)	[F80-OH1.1, OH1.2, OH1.3]
	[F20-OP2.1, OP2.3]
	[F80-OS1.2] Applies to assemblies required to provide fire resistance.
	[F80-OS2.1, OS2.3]
(2)	[F80-OH1.1, OH1.2, OH1.3]
	[F20-OP2.1, OP2.3]
	[F80-OS1.2] Applies to assemblies required to provide fire resistance.
	[F80-OS2.1, OS2.3]
9.20.13.2.	Fastening of Flashing
(1)	[F80-OH1.1, OH1.2, OH1.3]
	[F20-OP2.1, OP2.3]
	[F80-OS1.2] Applies to assemblies required to provide fire resistance.
	[F80-OS2.1, OS2.3]
9.20.13.3.	Location of Flashing
(1)	[F61, F62-OH1.1, OH1.2, OH1.3]
	[F61, F62-OP2.1, OP2.3]
	[F61, F62-OS2.1, OS2.3]
(2)	[F61, F62-OH1.1, OH1.2, OH1.3]
	[F61, F62-OP2.1, OP2.3]
	[F61, F62-OS2.1, OS2.3]
9.20.13.4.	Extension of Flashing
(1)	[F61-OH1.1, OH1.2, OH1.3]
	[F61-OP2.1, OP2.3]
	[F61-OS1.2] Applies to assemblies required to provide fire resistance.
	[F61-OS2.1, OS2.3]
(2)	
9.20.13.5.	Flashing for Weep Holes in Masonry Veneer/Masonry Walls
(1)	[F61, F62-OH1.1, OH1.2, OH1.3]
	[F61, F62-OP2.1, OP2.3]
	[F61-OS1.2] Applies to assemblies required to provide fire resistance.
	[F61, F62-OS2.1, OS2.3]
9.20.13.6.	Flashing for Weep Holes in Masonry Veneer
(1)	
(2)	[F61, F62-OH1.1, OH1.2, OH1.3]
	[F61, F62-OP2.1, OP2.3]
	[F61-OS1.2] Applies to assemblies required to provide fire resistance.
	[F61, F62-OS2.1, OS2.3]
(3)	[F61-OH1.1, OH1.2, OH1.3]
	[F61-OP2.1, OP2.3]
	[F61-OS1.2] Applies to assemblies required to provide fire resistance.
	[F61-OS2.1, OS2.3]
(4)	

Acceptable Solution	Objectives and Functional Statements
9.20.13.7.	Flashing Joints
(1)	[F61, F62-OH1.1, OH1.2, OH1.3] [F61, F62-OP2.1, OP2.3] [F61-OS1.2] Applies to assemblies required to provide fire resistance. [F61, F62-OS2.1, OS2.3]
9.20.13.8.	Required Weep Holes
(1)	[F62-OH1.1, OH1.2, OH1.3] [F62-OP2.1, OP2.3] [F62-OS1.2] Applies to assemblies required to provide fire resistance. [F62-OS2.1, OS2.3]
(2)	
(3)	[F61, F62-OH1.1, OH1.2, OH1.3] [F61, F62-OP2.1, OP2.3] [F61, F62-OS2.1, OS2.3]
9.20.13.9.	Protection of Interior Finish
(1)	[F61-OH1.1, OH1.2, OH1.3] [F61-OP2.1, OP2.3] [F61-OS2.1, OS2.3]
(2)	[F61, F62-OH1.1, OH1.2, OH1.3] [F61, F62-OP2.1, OP2.3] [F61, F62-OS2.1, OS2.3]
(3)	
9.20.13.10.	Mortar Droppings
(1)	[F61, F62-OH1.1, OH1.2, OH1.3] [F61, F62-OP2.1, OP2.3] [F61, F62-OS1.2] Applies to assemblies required to provide fire resistance. [F61, F62-OS2.1, OS2.3]
9.20.13.11.	Caulking at Door and Window Frames
(1)	
9.20.13.12.	Drips Beneath Window Sills
(1)	[F61, F62-OH1.1, OH1.2, OH1.3] [F61, F62-OP2.1, OP2.3] [F61, F62-OS1.2] Applies to assemblies required to provide fire resistance. [F61, F62-OS2.1, OS2.3]
9.20.14.1.	Laying Temperature of Mortar and Masonry
(1)	[F20, F80-OH1.1, OH1.2, OH1.3] Applies to elements that support or are part of an environmental separator. [F20, F80-OH4] Applies to floors and elements that support floors. [F20, F80-OP2.1, OP2.4] [F20, F80-OP2.3] Applies to elements that support or are part of an environmental separator or are exposed to moisture. [F20, F80-OS1.2] Applies to assemblies required to provide fire resistance. [F20, F80-OS1.3] [F20, F80-OS2.1] [F20, F80-OS2.3] Applies to elements that support or are part of an environmental separator or are exposed to moisture. [F20, F80-OS3.1] Applies to floors and elements that support floors. [F20, F80-OS3.7] Applies to walls, and elements that support walls, that contain doors or windows required for emergency egress.
(2)	[F20, F80-OH1.1, OH1.2, OH1.3] Applies to elements that support or are part of an environmental separator. [F20, F80-OH4] Applies to floors and elements that support floors. [F20, F80-OP2.1, OP2.4] [F20, F80-OP2.3] Applies to elements that support or are part of an environmental separator or are exposed to moisture.

Acceptable Solution	Objectives and Functional Statements	
(2) (Cont'd)	[F20, F80-OS1.2] Applies to assemblies required to provide fire resistance. [F20, F80-OS1.3] [F20, F80-OS2.1] [F20, F80-OS2.3] Applies to elements that support or are part of environmental separator or are exposed to moisture. [F20, F80-OS3.1] Applies to floors and elements that support floors. [F20, F80-OS3.7] Applies to walls, and elements that support walls, that contain doors or windows required for emergency egress.	
9.20.14.2.	Protection from Weather	
(1)	[F80-OP2.1, OP2.3] [F80-OS2.1, OS2.3]	
9.20.15.1.	Amount of Reinforcement	
(1)	[F20-OP2.1, OP2.3] [F20-OS2.1, OS2.3]	
r11.1	9.20.15.2.	Installation Standard
(1)	[F20-OP2.1, OP2.3] [F20-OS2.1, OS2.3]	
9.20.16.1.	Corrosion Resistance of Connectors	
(1)	[F80-OH1.1, OH1.2, OH1.3] Applies to elements that support or are part of an environmental separator. [F80-OH4] Applies to floors and elements that support floors. [F80-OP2.1, OP2.4] [F80-OP2.3] Applies to elements that support or are part of an environmental separator or are exposed to moisture. [F80-OS1.2] Applies to assemblies required to provide fire resistance. [F80-OS2.1] [F80-OS2.3] Applies to elements that support or are part of an environmental separator or are exposed to moisture. [F80-OS3.1] Applies to floors and elements that support floors. [F80-OS3.7] Applies to walls, and elements that support walls, that contain doors or windows required for emergency egress.	
9.20.17.1.	Thickness of Flat Insulating Concrete Form Walls	
(1)	[F20-OP2.1] [F22-OP2.4] [F20, F22-OP2.3] Applies to elements that support or are part of an environmental separator. [F20, F22-OH1.1, OH1.2, OH1.3] Applies to elements that support or are part of an environmental separator. [F20, F22-OH4] Applies to floors and elements that support floors. [F20-OS2.1] [F22-OS2.4] [F20, F22-OS2.3] Applies to elements that support or are part of an environmental separator. [F20, F22-OS3.1] Applies to floors and elements that support floors. [F20, F22-OS3.7] Applies to walls, and elements that support walls, that contain doors or windows required for emergency egress.	
9.20.17.2.	Reinforcement for Flat Insulating Concrete Form Walls	
(1)	[F20-OP2.1] [F22-OP2.4] [F20, F22-OP2.3] Applies to elements that support or are part of an environmental separator. [F20, F22-OH1.1, OH1.2, OH1.3] Applies to elements that support or are part of an environmental separator. [F20, F22-OH4] Applies to floors and elements that support floors. [F20-OS2.1] [F22-OS2.4] [F20, F22-OS2.3] Applies to elements that support or are part of an environmental separator. [F20, F22-OS3.1] Applies to floors and elements that support floors. [F20, F22-OS3.7] Applies to walls, and elements that support walls, that contain doors or windows required for emergency egress.	

Acceptable Solution	Objectives and Functional Statements
(2)	[F20-OP2.1] [F22-OP2.4] [F20, F22-OP2.3] Applies to elements that support or are part of an environmental separator. [F20, F22-OH1.1, OH1.2, OH1.3] Applies to elements that support or are part of an environmental separator. [F20, F22-OH4] Applies to floors and elements that support floors. [F20-OS2.1] [F22-OS2.4] [F20, F22-OS2.3] Applies to elements that support or are part of an environmental separator. [F20, F22-OS3.1] Applies to floors and elements that support floors. [F20, F22-OS3.7] Applies to walls, and elements that support walls, that contain doors or windows required for emergency egress.
(3)	[F20-OP2.1] [F22-OP2.4] [F20, F22-OP2.3] Applies to elements that support or are part of an environmental separator. [F20-OS2.1] [F22-OS2.4] [F20, F22-OS2.3] Applies to elements that support or are part of an environmental separator. [F20, F22-OH1.1, OH1.2, OH1.3] Applies to elements that support or are part of an environmental separator. [F20, F22-OH4] Applies to floors and elements that support floors. [F20, F22-OS3.1] Applies to floors and elements that support floors. [F20, F22-OS3.7] Applies to walls, and elements that support walls, that contain doors or windows required for emergency egress.
9.20.17.3.	Openings in Flat Non-Loadbearing Insulating Concrete Form Walls
(1)	[F20-OP2.1, OP2.3] [F22-OP2.3, OP2.4] [F20, F22-OH1.1, OH1.2, OH1.3] [F20, F22-OH4] Applies to floors and elements that support floors. [F20-OS2.1, OS2.3] [F22-OS2.3, OS2.4] [F20, F22-OS3.1] Applies to floors and elements that support floors. [F20, F22-OS3.7] Applies to walls, and elements that support walls, that contain doors or windows required for emergency egress.
(2)	[F20-OP2.1] [F22-OP2.4] [F20, F22-OP2.3] Applies to elements that support or are part of an environmental separator. [F20, F22-OH1.1, OH1.2, OH1.3] Applies to elements that support or are part of an environmental separator. [F20, F22-OH4] Applies to floors and elements that support floors. [F20-OS2.1] [F22-OS2.4] [F20, F22-OS2.3] Applies to elements that support or are part of an environmental separator. [F20, F22-OS3.1] Applies to floors and elements that support floors. [F20, F22-OS3.7] Applies to walls, and elements that support walls, that contain doors or windows required for emergency egress.
(3)	[F20-OP2.1] [F22-OP2.4] [F20, F22-OP2.3] Applies to elements that support or are part of an environmental separator. [F20, F22-OH1.1, OH1.2, OH1.3] Applies to elements that support or are part of an environmental separator. [F20, F22-OH4] Applies to floors and elements that support floors. [F20-OS2.1] [F22-OS2.4] [F20, F22-OS2.3] Applies to elements that support or are part of an environmental separator. [F20, F22-OS3.1] Applies to floors and elements that support floors. [F20, F22-OS3.7] Applies to walls, and elements that support walls, that contain doors or windows required for emergency egress.
(4)	[F20-OP2.1] [F22-OP2.4] [F20, F22-OP2.3] Applies to elements that support or are part of an environmental separator. [F20, F22-OH1.1, OH1.2, OH1.3] Applies to elements that support or are part of an environmental separator. [F20, F22-OH4] Applies to floors and elements that support floors.

Acceptable Solution	Objectives and Functional Statements
(4) (Cont'd)	[F20-OS2.1] [F22-OS2.4] [F20, F22-OS2.3] Applies to elements that support or are part of an environmental separator. [F20, F22-OS3.1] Applies to floors and elements that support floors. [F20, F22-OS3.7] Applies to walls, and elements that support walls, that contain doors or windows required for emergency egress.
(5)	[F20-OP2.1] [F22-OP2.4] [F20, F22-OP2.3] Applies to elements that support or are part of an environmental separator. [F20, F22-OH1.1, OH1.2, OH1.3] Applies to elements that support or are part of an environmental separator. [F20, F22-OH4] Applies to floors and elements that support floors. [F20-OS2.1] [F22-OS2.4] [F20, F22-OS2.3] Applies to elements that support or are part of an environmental separator. [F20, F22-OS3.1] Applies to floors and elements that support floors. [F20, F22-OS3.7] Applies to walls, and elements that support walls, that contain doors or windows required for emergency egress.
(6)	[F20-OP2.1] [F22-OP2.4] [F20, F22-OP2.3] Applies to elements that support or are part of an environmental separator. [F20, F22-OH1.1, OH1.2, OH1.3] Applies to elements that support or are part of an environmental separator. [F20, F22-OH4] Applies to floors and elements that support floors. [F20-OS2.1] [F22-OS2.4] [F20, F22-OS2.3] Applies to elements that support or are part of an environmental separator. [F20, F22-OS3.1] Applies to floors and elements that support floors. [F20, F22-OS3.7] Applies to walls, and elements that support walls, that contain doors or windows required for emergency egress.
9.20.17.4.	Openings in Loadbearing Flat Insulating Concrete Form Walls
(1)	[F20-OP2.1] [F22-OP2.4] [F20, F22-OP2.3] Applies to elements that support or are part of an environmental separator. [F20, F22-OH1.1, OH1.2, OH1.3] Applies to elements that support or are part of an environmental separator. [F20, F22-OH4] Applies to floors and elements that support floors. [F20-OS2.1] [F22-OS2.4] [F20, F22-OS2.3] Applies to elements that support or are part of an environmental separator. [F20, F22-OS3.1] Applies to floors and elements that support floors. [F20, F22-OS3.7] Applies to walls, and elements that support walls, that contain doors or windows required for emergency egress.
(2)	[F20-OP2.1] [F22-OP2.4] [F20, F22-OP2.3] Applies to elements that support or are part of an environmental separator. [F20, F22-OH1.1, OH1.2, OH1.3] Applies to elements that support or are part of an environmental separator. [F20, F22-OH4] Applies to floors and elements that support floors. [F20-OS2.1] [F22-OS2.4] [F20, F22-OS2.3] Applies to elements that support or are part of an environmental separator. [F20, F22-OS3.1] Applies to floors and elements that support floors. [F20, F22-OS3.7] Applies to walls, and elements that support walls, that contain doors or windows required for emergency egress.
(3)	[F20-OP2.1] [F22-OP2.4] [F20, F22-OP2.3] Applies to elements that support or are part of an environmental separator. [F20, F22-OH1.1, OH1.2, OH1.3] Applies to elements that support or are part of an environmental separator. [F20, F22-OH4] Applies to floors and elements that support floors.

Acceptable Solution	Objectives and Functional Statements
(3) (Cont'd)	[F20-OS2.1] [F22-OS2.4] [F20, F22-OS2.3] Applies to elements that support or are part of an environmental separator. [F20, F22-OS3.7] Applies to floors and elements that support floors. [F20, F22-OS3.7] Applies to walls, and elements that support walls, that contain doors or windows required for emergency egress.
(4)	[F20-OH1.1, OH1.2, OH1.3] Applies to elements that support or are part of an environmental separator. [F20-OH4] Applies to floors and elements that support floors. [F20-OP2.1] [F20-OP2.3] Applies to elements that support or are part of an environmental separator. [F20-OS2.1] [F20-OS2.3] Applies to elements that support or are part of an environmental separator. [F20-OS3.1] Applies to floors and elements that support floors.
9.20.17.5.	Framing Supported on Flat Insulating Concrete Form Walls
(1)	[F20, F22-OH4] [F20-OP2.1] [F22-OP2.4] [F20, F22-OP2.3] Applies to elements that support or are part of an environmental separator. [F20-OS2.1] [F22-OS2.4] [F20, F22-OS2.3] Applies to elements that support or are part of an environmental separator. [F20, F22-OS3.1]
(2)	[F20, F22-OH4] [F20-OP2.1] [F22-OP2.4] [F20, F22-OP2.3] Applies to elements that support or are part of an environmental separator. [F20-OS2.1] [F22-OS2.4] [F20, F22-OS2.3] Applies to elements that support or are part of an environmental separator. [F20, F22-OS3.1]
(3)	[F20, F22-OH4] [F20-OP2.1] [F22-OP2.4] [F20, F22-OP2.3] Applies to elements that support or are part of an environmental separator. [F20-OS2.1] [F22-OS2.4] [F20, F22-OS2.3] Applies to elements that support or are part of an environmental separator. [F20, F22-OS3.1]
(4)	
9.20.17.6.	Anchoring of Roof Framing to Top of Flat Insulating Concrete Form Walls
(1)	[F20-OP2.1, OP2.3] [F22-OP2.3, OP2.4] [F20-OS2.1, OS2.3] [F22-OS2.3, OS2.4] [F20, F22-OH1.1, OH1.2, OH1.3]
(2)	[F20-OH1.1, OH1.2, OH1.3] [F20-OP2.1, OP2.3] [F22-OP2.3, OP2.4] [F20-OS2.1, OS2.3] [F22-OS2.3, OS2.4]
(3)	
9.20.17.7.	Protection from Precipitation and Damage
(1)	
9.21.1.1.	Application
(1)	
(2)	
9.21.1.2.	Factory-Built Chimneys
(1)	[F01-OP1.1] Applies to the walls of any <i>chimney</i> or <i>flue pipe</i> , which are required to be constructed to be flame-tight.

Acceptable Solution	Objectives and Functional Statements
(1) (Cont'd)	[F01-OS1.1] Applies to the walls of any <i>chimney</i> or <i>flue pipe</i> , which are required to be constructed to be flame-tight. [F44-OH1.1] Applies to the walls of any <i>chimney</i> or <i>flue pipe</i> , which are required to be constructed to be smoke-tight.
9.21.1.3.	Flue Pipes
(1)	[F01-OP1.1] Applies to the walls of any <i>chimney</i> or <i>flue pipe</i> , which are required to be constructed to be flame-tight. [F01-OS1.1] Applies to the walls of any <i>chimney</i> or <i>flue pipe</i> , which are required to be constructed to be flame-tight. [F44-OH1.1] Applies to the walls of any <i>chimney</i> or <i>flue pipe</i> , which are required to be constructed to be smoke-tight.
9.21.1.4.	Chimney or Flue Pipe Walls
(1)	[F01-OP1.1] Applies to the walls of any <i>chimney</i> or <i>flue pipe</i> , which are required to be constructed to be flame-tight. [F01-OS1.1] Applies to the walls of any <i>chimney</i> or <i>flue pipe</i> , which are required to be constructed to be flame-tight. [F44-OH1.1] Applies to the walls of any <i>chimney</i> or <i>flue pipe</i> , which are required to be constructed to be smoke-tight.
9.21.2.1.	Chimney Flue Limitations
(1)	[F44-OH1.1] [F44-OS3.4]
(2)	[F44-OH1.1] [F44-OS3.4]
(3)	[F44-OH1.1] [F44-OS3.4]
9.21.2.2.	Connections of More Than One Appliance
(1)	[F44-OH1.1] [F44-OS3.4]
(2)	[F44-OS3.4]
(3)	[F44-OH1.1] [F44-OS3.4]
9.21.2.3.	Inclined Chimney Flues
(1)	[F44-OH1.1] [F44-OS3.4]
9.21.2.4.	Size of Chimney Flues
(1)	
(2)	[F44-OH1.1] [F44-OS3.4]
9.21.2.5.	Fireplace Chimneys
(1)	[F44-OH1.1] [F44-OS3.4]
9.21.2.6.	Oval Chimney Flues
(1)	[F44-OH1.1] [F44-OS3.4]
9.21.3.1.	Lining Materials
(1)	[F20-OH1.1] [F01-OS1.1] [F20-OS2.3] [F44-OS3.4] [F01, F20, F44-OP1.1]
9.21.3.2.	Joints in Chimney Liners
(1)	[F01-OP1.1] [F44-OH1.1]

Acceptable Solution	Objectives and Functional Statements
(1) (Cont'd)	[F01-OS1.1]
	[F20, F44-OS2.3]
	[F01-OS3.4]
(2)	[F01-OP1.1]
	[F44-OH1.1]
	[F01-OS1.1]
	[F01-OS3.4]
9.21.3.3.	Clay Liners
(1)	[F01-OS1.1]
	[F20-OS2.2]
	[F20, F44-OS3.4]
	[F01, F20-OP1.1]
	[F20, F44-OH1.1]
(2)	[F01, F20-OP1.1]
	[F44-OH1.1]
	[F01, F20-OS1.1]
	[F20-OS2.3] Applies to the liners referred to in Sentence (1), which are required to be not less than 15.9 mm thick.
	[F44-OS3.4]
9.21.3.4.	Firebrick Liners
(1)	[F01-OP1.1]
	[F01-OS1.1]
	[F20, F44-OS3.4]
	[F44-OH1.1]
(2)	[F01, F20-OP1.1]
	[F20-OH1.1]
	[F01, F20-OS1.1]
	[F20-OS2.2]
	[F20, F44-OS3.4]
9.21.3.5.	Concrete Liners
(1)	[F01-OP1.1]
	[F01, F20-OS1.1]
	[F20-OS2.3]
	[F20, F44-OS3.4]
	[F44-OH1.1]
9.21.3.6.	Metal Liners
(1)	[F01, F20-OP1.1]
	[F20, F44-OH1.1]
	[F01, F20-OS1.1]
	[F20-OS2.3]
	[F20, F44-OS3.4]
(2)	[F20-OP1.1]
	[F01, F20-OS1.1]
	[F20-OS2.3]
	[F20, F44-OS3.4]
	[F44-OH1.1]
9.21.3.7.	Installation of Chimney Liners
(1)	[F01-OP1.1]
	[F01-OS1.1]
	[F20-OS2.3]
	[F44-OS3.4]
	[F44-OH1.1]

Acceptable Solution	Objectives and Functional Statements
9.21.3.8.	Spaces Between Liners and Surrounding Masonry
(1)	[F01-OP1.1] [F01-OS1.1] [F20-OS2.3]
(2)	[F01-OP1.1] [F44-OH1.1] [F20-OS1.1] [F20-OS2.3] [F44-OS3.4]
9.21.3.9.	Mortar for Chimney Liners
(1)	[F20, F44-OH1.1] [F20, F44-OS3.4] (a), (b) [F01, F20-OP1.1] (a), (b) [F01, F20-OS1.1] (b) [F20-OS2.3]
(2)	[F01, F20-OP1.1] [F20, F44-OH1.1] [F01, F20-OS1.1] [F20-OS2.3] [F44-OS3.4]
9.21.3.10.	Extension of Chimney Liners
(1)	[F01-OP1.1] [F01-OS1.1] [F20-OS2.3] [F44-OS3.4] [F20, F44-OH1.1]
9.21.4.1.	Unit Masonry
(1)	
9.21.4.2.	Concrete
(1)	
9.21.4.3.	Footings
(1)	
9.21.4.4.	Height of Chimney Flues
(1)	(a), (b) [F44-OH1.1] (a), (b) [F44-OS3.4]
9.21.4.5.	Lateral Stability
(1)	
(2)	
9.21.4.6.	Chimney Caps
(1)	[F01-OP1.1] [F20, F44-OH1.1] [F01-OS1.1] [F20-OS2.3] [F44-OS3.4]
(2)	[F20-OS2.3]
(3)	[F01, F20-OP1.1] [F01, F20-OS1.1] [F20-OS2.3] [F20, F44-OS3.4]
(4)	[F01, F20-OP1.1] [F20, F44-OH1.1] [F01, F20-OS1.1]

Acceptable Solution	Objectives and Functional Statements
(4) (Cont'd)	[F20-OS2.3] [F20, F44-OS3.4]
9.21.4.7.	Cleanout
(1)	[F01-OP1.1] [F01-OS1.1]
9.21.4.8.	Wall Thickness
(1)	[F01-OP1.1] [F22-OP2.1] [F01-OS1.1] [F20, F22-OS2.1]
9.21.4.9.	Separation of Flue Liners
(1)	[F01-OS1.1] [F20, F22-OS2.3] [F44-OS3.4] [F01, F20-OP1.1] [F20, F44-OH1.1]
(2)	[F01-OS1.1] [F20, F22-OS2.3] [F20, F44-OS3.4] [F20, F44-OH1.1]
9.21.4.10.	Flashing
(1)	[F20, F61-OS2.3]
9.21.5.1.	Clearance from Combustible Materials
(1)	(a), (b) [F01-OP1.1] (a), (b) [F01-OS1.1]
(2)	[F01-OP1.1] [F01-OS1.1]
(3)	[F01-OP1.1] [F01-OS1.1]
9.21.5.2.	Sealing of Spaces
(1)	[F01-OP1.1] [F01-OS1.1]
9.21.5.3.	Support of Joists or Beams
(1)	[F01-OP1.1] [F01-OS1.1]
9.22.1.1.	Application
(1)	
9.22.1.2.	Masonry and Concrete
(1)	
(2)	[F22, F20-OS2.3]
9.22.1.3.	Footings
(1)	
9.22.1.4.	Combustion Air
(1)	[F50, F81-OH1.1] [F44, F81-OS3.4]
(2)	[F01, F80-OP1.1] [F03-OP1.2] [F01, F80-OS1.1] [F03-OS1.2]
(3)	[F50, F81-OH1.1] [F44, F81-OS3.4]
(4)	[F54-OH1.2]
(5)	[F50, F81-OH1.1] [F44, F81-OS3.4]

Acceptable Solution	Objectives and Functional Statements
(6)	(a) [F50, F81-OH1.1]
	(a) [F44, F81-OS3.4]
	(b) [F03-OP1.2]
	(b) [F03-OS1.2]
(7)	[F01-OP1.1]
	[F01-OS1.1]
9.22.2.1.	Brick or Steel Liners
(1)	[F01, F20-OP1.1]
	[F01, F20-OS1.1]
9.22.2.2.	Firebrick Liners
(1)	(a), (b) [F01-OP1.1]
	(a), (b) [F01-OS1.1]
(2)	[F01-OP1.1]
	[F01-OS1.1]
(3)	[F01-OP1.1]
	[F01-OS1.1]
9.22.2.3.	Steel Liners
(1)	[F01-OP1.1]
	[F01-OS1.1]
	[F44-OS3.4]
	[F44-OH1.1]
9.22.3.1.	Thickness of Walls
(1)	[F01-OP1.1]
	[F01-OS1.1]
(2)	(a), (b) [F01-OP1.1]
	(a), (b) [F01-OS1.1]
9.22.4.1.	Fire Chamber Dimensions
(1)	[F22-OH1.1]
	[F44-OS3.4]
9.22.5.1.	Hearth Extension
(1)	[F01-OP1.1]
	[F01-OS1.1]
(2)	(a), (b) [F01-OP1.1]
	(a), (b) [F01-OS1.1]
9.22.5.2.	Support of Hearth
(1)	[F01-OS1.1]
	[F20-OS2.3]
	[F01, F20-OP1.1]
(2)	[F01-OP1.1]
	[F01-OS1.1]
9.22.6.1.	Required Damper and Size
(1)	[F01-OP1.1]
	[F01-OS1.1]
	[F54-OH1.2]
9.22.7.1.	Slope of Smoke Chamber
(1)	[F44-OH1.1]
	[F44-OS3.4]
9.22.7.2.	Wall Thickness
(1)	[F01-OP1.1]
	[F01-OS1.1]

Acceptable Solution	Objectives and Functional Statements
9.22.8.1.	Conformance to Standard
(1)	[F01-OP1.1]
	[F01-OS1.1]
	[F44-OS3.4]
	[F44-OH1.1]
9.22.9.1.	Clearance to the Fireplace Opening
(1)	[F01-OP1.1]
	[F01-OS1.1]
9.22.9.2.	Metal Exposed to the Interior
(1)	[F01-OP1.1]
	[F01-OS1.1]
9.22.9.3.	Clearance to Combustible Framing
(1)	[F01-OP1.1]
	[F01-OS1.1]
(2)	[F01-OP1.1]
	[F01-OS1.1]
9.22.9.4.	Heat Circulating Duct Openings
(1)	(a), (b) [F01-OP1.1]
	(a), (b) [F01-OS1.1]
9.22.10.1.	Appliance Standard
(1)	[F01-OP1.1]
	[F01-OS1.1]
	[F44-OS3.4]
	[F44-OH1.1]
9.22.10.2.	Installation
(1)	[F01-OP1.1]
	[F01-OS1.1]
	[F44-OS3.4]
	[F44-OH1.1]
(2)	
(3)	[F01-OP1.1]
	[F01-OS1.1]
	[F44-OS3.4]
	[F44-OH1.1]
9.23.1.1.	Limitations
(1)	
(2)	
9.23.2.1.	Strength and Rigidity
(1)	[F20-OP2.1]
	[F20, F22-OP2.4, OP2.5]
	[F20, F22-OP2.3] Applies to elements that support or are part of an environmental separator.
	[F20, F22-OH1.1, OH1.2, OH1.3] Applies to elements that support or are part of an environmental separator.
	[F20, F22-OS1.2] Applies to assemblies required to provide fire resistance.
	[F22-OH4] Applies to floors and elements that support floors.
	[F20-OS2.1]
	[F20, F22-OS2.5]
	[F20, F22-OS2.3] Applies to elements that support or are part of an environmental separator.
	[F22-OS3.1] Applies to floors and elements that support floors.
	[F22-OS3.7] Applies to walls, and elements that support walls, that contain doors or windows required for emergency egress.
9.23.2.2.	Protection from Decay
(1)	[F80-OP2.3, OP2.4]
	[F80-OH1.1, OH1.2, OH1.3] Applies to elements that support or are part of an environmental separator.

Acceptable Solution	Objectives and Functional Statements
(1) (Cont'd)	[F80-OH4] Applies to floors and elements that support floors. [F80-OS1.2] Applies to assemblies required to provide fire resistance. [F80-OS2.3] [F80-OS3.1] Applies to floors and elements that support floors. [F80-OS3.7] Applies to walls, and elements that support walls, that contain doors or windows required for emergency egress.
(2)	[F81-OP2.3] [F81-OH1.1, OH1.2, OH1.3] Applies to elements that support or are part of an environmental separator. [F81-OH4] Applies to floors and elements that support floors. [F81-OS1.2] Applies to assemblies required to provide fire resistance. [F81-OS2.3] [F81-OS3.1] Applies to floors and elements that support floors.
9.23.2.3.	Protection from Dampness
(1)	[F80-OP2.1, OP2.3, OP2.4] [F80-OH1.1, OH1.2, OH1.3] Applies to elements that support or are part of an environmental separator. [F80-OH4] Applies to floors and elements that support floors. [F80-OS1.2] Applies to assemblies required to provide fire resistance. [F80-OS2.1, OS2.3] [F80-OS3.1] Applies to floors and elements that support floors.
(2)	
9.23.2.4.	Lumber
(1)	
9.23.2.5.	Termite Protection
(1)	[F80, F81, F82-OH4] [F80, F81, F82-OP2.3, OP2.4] [F10-OS1.5] [F80, F81, F82-OS2.3] [F80, F81, F82-OS3.1]
(2)	[F80, F81, F82-OH4] [F80, F81, F82-OP2.3, OP2.4] [F80, F81, F82-OS2.3] [F80, F81, F82-OS3.1]
9.23.3.1.	Standards for Nails and Screws
(1)	[F20-OP2.1] [F20, F22-OP2.4, OP2.5] [F20, F22-OP2.3] Applies to elements that support or are part of an environmental separator. [F20, F22-OS1.2] Applies to assemblies required to provide fire resistance. [F20-OS2.1] [F20, F22-OS2.5] [F20, F22-OS2.5] Applies to elements that support or are part of an environmental separator. [F22-OS3.1] Applies to floors and elements that support floors. [F22-OS3.7] Applies to walls, and elements that support walls, that contain doors or windows required for emergency egress. [F20, F22-OH1.1, OH1.2, OH1.3] Applies to elements that support or are part of an environmental separator. [F22-OH4] Applies to floors and elements that support floors.
(2)	[F20-OP2.1] [F20, F22-OP2.4, OP2.5] [F20, F22-OP2.3] Applies to elements that support or are part of an environmental separator. [F20, F22-OS1.2] Applies to assemblies required to provide fire resistance. [F20-OS2.1] [F20, F22-OS2.5] [F20, F22-OS2.3] Applies to elements that support or are part of an environmental separator. [F20, F22-OH1.1, OH1.2, OH1.3] Applies to elements that support or are part of an environmental separator. [F22-OH4] Applies to floors and elements that support floors.

R3

Acceptable Solution	Objectives and Functional Statements
r3 (3)	[F20-OP2.1, OP2.5] [F22-OP2.4, OP2.5] [F20, F22-OP2.3] Applies to elements that support or are part of an environmental separator [F20, F22-OS1.2] Applies to assemblies required to provide fire resistance. [F20-OS2.1] [F20, F22-OS2.5] [F20, F22-OS2.3] Applies to elements that support or are part of an environmental separator. [F22-OS3.1] Applies to floors and elements that support floors. [F22-OS3.7] Applies to walls, and elements that support walls, that contain doors or windows required for emergency egress.
9.23.3.2.	Length of Nails
(1)	[F20-OP2.1, OP2.5] [F22-OP2.4, OP2.5] [F20, F22-OP2.3] Applies to elements that support or are part of an environmental separator. [F20, F22-OS1.2] Applies to assemblies required to provide fire resistance. [F20-OS2.1] [F20, F22-OS2.5] [F20, F22-OS2.3] Applies to elements that support or are part of an environmental separator. [F22-OS3.1] Applies to floors and elements that support floors. [F22-OS3.7] Applies to walls, and elements that support walls, that contain doors or windows required for emergency egress. [F20, F22-OH1.1, OH1.2, OH1.3] Applies to elements that support or are part of an environmental separator. [F22-OH4] Applies to floors and elements that support floors.
9.23.3.3.	Prevention of Splitting
(1)	[F80-OH1.1, OH1.2, OH1.3] Applies to elements that support or are part of an environmental separator. [F80-OH4] Applies to floors and elements that support floors. [F80-OP2.1, OP2.4] [F80-OP2.3] Applies to elements that support or are part of an environmental separator. [F80-OS1.2] Applies to assemblies required to provide fire resistance. [F80-OS2.1] [F80-OS2.3] Applies to elements that support or are part of an environmental separator. [F80-OS3.1] Applies to floors and elements that support floors.
9.23.3.4.	Nailing of Framing
(1)	[F20-OP2.1, OP2.5] [F22-OP2.4, OP2.5] [F20, F22-OP2.3] Applies to elements that support or are part of an environmental separator. [F20, F22-OS1.2] Applies to assemblies required to provide fire resistance. [F20-OS2.1] [F20, F22-OS2.5] [F20, F22-OS2.3] Applies to elements that support or are part of an environmental separator. [F22-OS3.1] Applies to floors and elements that support floors. [F22-OS3.7] Applies to walls, and elements that support walls, that contain doors or windows required for emergency egress. [F20, F22-OH1.1, OH1.2, OH1.3] Applies to elements that support or are part of an environmental separator. [F22-OH4] Applies to floors and elements that support floors.
(2)	[F20-OP2.1, OP2.5] [F22-OP2.4, OP2.5] [F20, F22-OP2.3] Applies to elements that support or are part of an environmental separator. [F20, F22-OS1.2] Applies to assemblies required to provide fire resistance. [F20-OS2.1] [F20, F22-OS2.5] [F20, F22-OS2.3] Applies to elements that support or are part of an environmental separator. [F22-OS3.1] Applies to floors and elements that support floors. [F22-OS3.7] Applies to walls, and elements that support walls, that contain doors or windows required for emergency egress. [F20, F22-OH1.1, OH1.2, OH1.3] Applies to elements that support or are part of an environmental separator.

Acceptable Solution	Objectives and Functional Statements
(2) (Cont'd)	[F22-OH4] Applies to floors and elements that support floors.
9.23.3.5.	Fastening for Sheathing or Subflooring
(1)	[F20-OP2.1, OP2.5] [F22-OP2.4, OP2.5] [F20, F22-OP2.3] Applies to elements that support or are part of an environmental separator. [F20, F22-OS1.2] Applies to assemblies required to provide fire resistance. F20-OS2.1] [F20, F22-OS2.5] [F20, F22-OS2.3] Applies to elements that support or are part of an environmental separator. F22-OS3.1] Applies to floors and elements that support floors. [F22-OS3.7] Applies to walls, and elements that support walls, that contain doors or windows required for emergency egress. F20, F22-OH1.1, OH1.2, OH1.3] Applies to elements that support or are part of an environmental separator. F22-OH4] Applies to floors and elements that support floors.
(2)	[F20-OP2.1, OP2.5] [F22-OP2.4, OP2.5] [F20, F22-OP2.3] Applies to elements that support or are part of an environmental separator. [F20, F22-OS1.2] Applies to assemblies required to provide fire resistance. [F20-OS2.1] [F20, F22-OS2.5] [F20, F22-OS2.3] Applies to elements that support or are part of an environmental separator. [F22-OS3.1] Applies to floors and elements that support floors. [F22-OS3.7] Applies to walls, and elements that support walls, that contain doors or windows required for emergency egress. [F20, F22-OH1.1, OH1.2, OH1.3] Applies to elements that support or are part of an environmental separator. [F22-OH4] Applies to floors and elements that support floors.
(3)	[F20-OP2.1, OP2.5] [F22-OP2.4, OP2.5] [F20, F22-OP2.3] Applies to elements that support or are part of an environmental separator. [F20, F22-OS1.2] Applies to assemblies required to provide fire resistance. [F20-OS2.1] [F20, F22-OS2.5] [F20, F22-OS2.3] Applies to elements that support or are part of an environmental separator. [F22-OS3.1] Applies to floors and elements that support floors. [F22-OS3.7] Applies to walls, and elements that support walls, that contain doors or windows required for emergency egress. [F20, F22-OH1.1, OH1.2, OH1.3] Applies to elements that support or are part of an environmental separator. [F22-OH4] Applies to floors and elements that support floors.
(4)	[F20-OP2.1] [F22-OP2.4] [F20-OS1.2] Applies to assemblies required to provide fire resistance. [F20, F22-OS2.1] [F22-OS3.1] Applies to floors and elements that support floors. [F22-OH4] Applies to floors and elements that support floors.

Acceptable Solution	Objectives and Functional Statements
(5)	[F20-OP2.1, OP2.5] [F22-OP2.4, OP2.5] [F20, F22-OP2.3] Applies to elements that support or are part of an environmental separator. [F20, F22-OS1.2] Applies to assemblies required to provide fire resistance. [F20-OS2.1] [F20, F22-OS2.5] [F20, F22-OS2.3] Applies to elements that support or are part of an environmental separator. [F22-OS3.1] Applies to floors and elements that support floors. [F22-OS3.7] Applies to walls, and elements that support walls, that contain doors or windows required for emergency egress. [F20, F22-OH1.1, OH1.2, OH1.3] Applies to elements that support or are part of an environmental separator. [F22-OH4] Applies to floors and elements that support floors.
9.23.4.1.	Application
(1)	
(2)	
9.23.4.2.	Spans for Joists, Rafters and Beams
(1)	[F20-OP2.1, OP2.5] [F22-OP2.4, OP2.5] [F20, F22-OP2.3] Applies to elements that support or are part of an environmental separator.

This Page
Intentionally Left Blank

Acceptable Solution	Objectives and Functional Statements
(1) (Cont'd)	[F20, F22-OH1.1, OH1.2, OH1.3] Applies to elements that support or are part of an environmental separator. [F22-OH4] Applies to floors and elements that support floors. [F20, F22-OS1.2] Applies to assemblies required to provide fire resistance. [F20-OS2.1, OS2.5] [F22-OS2.4, OS2.5] [F20, F22-OS2.3] Applies to elements that support or are part of an environmental separator. [F22-OS3.1] Applies to floors and elements that support floors. [F22-OS3.7] Applies to walls, and elements that support walls, that contain doors or windows required for emergency egress.
(2)	[F20-OP2.1, OP2.5] [F22-OP2.4, OP2.5] [F20, F22-OP2.3] Applies to elements that support or are part of an environmental separator. [F20, F22-OH1.1, OH1.2, OH1.3] Applies to elements that support or are part of an environmental separator. [F22-OH4] Applies to floors and elements that support floors. [F20, F22-OS1.2] Applies to assemblies required to provide fire resistance. [F20-OS2.1, OS2.5] [F22-OS2.4, OS2.5] [F20, F22-OS2.3] Applies to elements that support or are part of an environmental separator. [F22-OS3.1] Applies to floors and elements that support floors. [F22-OS3.7] Applies to walls, and elements that support walls, that contain doors or windows required for emergency egress.
(3)	[F20-OP2.1, OP2.3, OP2.5] [F20-OS2.1, OS2.3, OS2.5]
(4)	[F20-OP2.1, OP2.3, OP2.5] [F20-OS2.1, OS2.3, OS2.5]
9.23.4.3.	Steel Beams
(1)	[F20-OP2.1, OP2.5] [F22-OP2.4, OP2.5] [F20, F22-OP2.3] Applies to elements that support or are part of an environmental separator. [F20, F22-OH1.1, OH1.2, OH1.3] Applies to elements that support or are part of an environmental separator. [F22-OH4] Applies to floors and elements that support floors. [F20, F22-OS1.2] Applies to assemblies required to provide fire resistance. [F20-OS2.1, OS2.5] [F22-OS2.4, OS2.5] [F20, F22-OS2.3] Applies to elements that support or are part of an environmental separator. [F22-OS3.1] Applies to floors and elements that support floors. [F22-OS3.7] Applies to walls, and elements that support walls, that contain doors or windows required for emergency egress.
(2)	[F20-OP2.1, OP2.5] [F22-OP2.4, OP2.5] [F20, F22-OP2.3] Applies to elements that support or are part of an environmental separator. [F20, F22-OH1.1, OH1.2, OH1.3] Applies to elements that support or are part of an environmental separator. [F22-OH4] Applies to floors and elements that support floors. [F20, F22-OS1.2] Applies to assemblies required to provide fire resistance. [F20-OS2.1, OS2.5] [F22-OS2.4, OS2.5] [F20, F22-OS2.3] Applies to elements that support or are part of an environmental separator. [F22-OS3.1] Applies to floors and elements that support floors. [F22-OS3.7] Applies to walls, and elements that support walls, that contain doors or windows required for emergency egress.
(3)	
9.23.4.4.	Concrete Topping
(1)	[F20-OP2.1, OP2.5] [F22-OP2.4, OP2.5] [F20, F22-OP2.3] Applies to elements that support or are part of an environmental separator.

Acceptable Solution	Objectives and Functional Statements
(1) (Cont'd)	[F20, F22-OH1.1, OH1.2, OH1.3] Applies to elements that support or are part of an environmental separator. [F22-OH4] Applies to floors and elements that support floors. [F20, F22-OS1.2] Applies to assemblies required to provide fire resistance. [F20-OS2.1, OS2.5] [F22-OS2.4, OS2.5] [F20, F22-OS2.3] Applies to elements that support or are part of an environmental separator. [F22-OS3.1] Applies to floors and elements that support floors. [F22-OS3.7] Applies to walls, and elements that support walls, that contain doors or windows required for emergency egress.
(2)	[F20-OP2.1, OP2.5] [F22-OP2.4, OP2.5] [F20, F22-OP2.3] Applies to elements that support or are part of an environmental separator. [F20, F22-OH1.1, OH1.2, OH1.3] Applies to elements that support or are part of an environmental separator. [F22-OH4] Applies to floors and elements that support floors. [F20, F22-OS1.2] Applies to assemblies required to provide fire resistance. [F20-OS2.1, OS2.5] [F22-OS2.4, OS2.5] [F20, F22-OS2.3] Applies to elements that support or are part of an environmental separator. [F22-OS3.1] Applies to floors and elements that support floors. [F22-OS3.7] Applies to walls, and elements that support walls, that contain doors or windows required for emergency egress.
(3)	[F20-OP2.1, OP2.5] [F22-OP2.4, OP2.5] [F20, F22-OP2.3] Applies to elements that support or are part of an environmental separator. [F20, F22-OH1.1, OH1.2, OH1.3] Applies to elements that support or are part of an environmental separator. [F22-OH4] Applies to floors and elements that support floors. [F20, F22-OS1.2] Applies to assemblies required to provide fire resistance. [F20-OS2.1, OS2.5] [F22-OS2.4, OS2.5] [F20, F22-OS2.3] Applies to elements that support or are part of an environmental separator. [F22-OS3.1] Applies to floors and elements that support floors. [F22-OS3.7] Applies to walls, and elements that support walls, that contain doors or windows required for emergency egress.
9.23.4.5.	Heavy Roofing Materials
(1)	[F20-OP2.1, OP2.5] [F22-OP2.4, OP2.5] [F20, F22-OP2.3] Applies to elements that support or are part of an environmental separator. [F20, F22-OH1.1, OH1.2, OH1.3] Applies to elements that support or are part of an environmental separator. [F20, F22-OS1.2] Applies to assemblies required to provide fire resistance. [F20-OS2.1, OS2.5] [F22-OS2.4, OS2.5] [F20, F22-OS2.3] Applies to elements that support or are part of an environmental separator. [F22-OS3.1] Applies to floors and elements that support floors. [F22-OS3.7] Applies to walls, and elements that support walls, that contain doors or windows required for emergency egress.
9.23.5.1.	Holes Drilled in Framing Members
(1)	[F20-OP2.1, OP2.5] [F22-OP2.4, OP2.5] [F20, F22-OP2.3] Applies to elements that support or are part of an environmental separator. [F20, F22-OH1.1, OH1.2, OH1.3] Applies to elements that support or are part of an environmental separator. [F22-OH4] Applies to floors and elements that support floors. [F20, F22-OS1.2] Applies to assemblies required to provide fire resistance. [F20-OS2.1, OS2.5] [F22-OS2.5] [F20, F22-OS2.3] Applies to elements that support or are part of an environmental separator.

Acceptable Solution	Objectives and Functional Statements
(1) (Cont'd)	[F22-OS3.1] Applies to floors and elements that support floors. [F22-OS3.7] Applies to walls, and elements that support walls, that contain doors or windows required for emergency egress.
9.23.5.2.	Notching of Framing Members
(1)	[F20-OP2.1, OP2.5] [F22-OP2.4, OP2.5] [F20, F22-OP2.3] Applies to elements that support or are part of an environmental separator. [F20, F22-OH1.1, OH1.2, OH1.3] Applies to elements that support or are part of an environmental separator. [F22-OH4] Applies to floors and elements that support floors. [F20, F22-OS1.2] Applies to assemblies required to provide fire resistance. [F20-OS2.1, OS2.5] [F22-OS2.5] [F20, F22-OS2.3] Applies to elements that support or are part of an environmental separator. [F22-OS3.1] Applies to floors and elements that support floors. [F22-OS3.7] Applies to walls, and elements that support walls, that contain doors or windows required for emergency egress.
9.23.5.3.	Wall Studs
(1)	[F20-OP2.1, OP2.5] [F22-OP2.4, OP2.5] [F20, F22-OP2.3] Applies to elements that support or are part of an environmental separator. [F20, F22-OH1.1, OH1.2, OH1.3] Applies to elements that support or are part of an environmental separator. [F22-OH4] Applies to floors and elements that support floors. [F20, F22-OS1.2] Applies to assemblies required to provide fire resistance. [F20-OS2.1, OS2.5] [F22-OS2.5] [F20, F22-OS2.3] Applies to elements that support or are part of an environmental separator. [F22-OS3.1] Applies to floors and elements that support floors. [F22-OS3.7] Applies to walls, and elements that support walls, that contain doors or windows required for emergency egress.
9.23.5.4.	Top Plates
(1)	[F20-OP2.1, OP2.5] [F22-OP2.4, OP2.5] [F20, F22-OP2.3] Applies to elements that support or are part of an environmental separator. [F20, F22-OH1.1, OH1.2, OH1.3] Applies to elements that support or are part of an environmental separator. [F22-OH4] Applies to floors and elements that support floors. [F20, F22-OS1.2] Applies to assemblies required to provide fire resistance. [F20-OS2.1, OS2.5] [F22-OS2.5] [F20, F22-OS2.3] Applies to elements that support or are part of an environmental separator. [F22-OS3.1] Applies to floors and elements that support floors. [F22-OS3.7] Applies to walls, and elements that support walls, that contain doors or windows required for emergency egress.
9.23.5.5.	Roof Trusses
(1)	[F20-OP2.1, OP2.5] [F22-OP2.4, OP2.5] [F20, F22-OP2.3] Applies to elements that support or are part of an environmental separator. [F20, F22-OH1.1, OH1.2, OH1.3] Applies to elements that support or are part of an environmental separator. [F20, F22-OS1.2] Applies to assemblies required to provide fire resistance. [F20-OS2.1, OS2.5] [F22-OS2.5] [F20, F22-OS2.3] Applies to elements that support or are part of an environmental separator.
9.23.6.1.	Anchorage of Building Frames
(1)	[F20-OH1.1, OH1.2, OH1.3] Applies to elements that support or are part of an environmental separator. [F22-OH4] Applies to floors and elements that support floors.

Acceptable Solution	Objectives and Functional Statements
(1) (Cont'd)	[F20-OP2.1, OP2.5] [F22-OP2.4, OP2.5] [F20, F22-OP2.3] Applies to elements that support or are part of an environmental separator. [F20-OS2.1, OS2.5] [F22-OS2.5] [F20, F22-OS2.3] Applies to elements that support or are part of an environmental separator. [F20-OS3.1] Applies to floors and elements that support floors.
(2)	[F20-OH1.1, OH1.2, OH1.3] Applies to elements that support or are part of an environmental separator. [F22-OH4] Applies to floors and elements that support floors. [F20-OP2.1, OP2.5] [F22-OP2.4, OP2.5] [F20, F22-OP2.3] Applies to elements that support or are part of an environmental separator. [F20-OS2.1, OS2.5] [F22-OS2.5] [F20, F22-OS2.3] Applies to elements that support or are part of an environmental separator. [F20-OS3.1] Applies to floors and elements that support floors.
(3)	[F20-OH1.1, OH1.2, OH1.3] Applies to elements that support or are part of an environmental separator. [F22-OH4] Applies to floors and elements that support floors. [F20-OP2.1, OP2.5] [F22-OP2.4, OP2.5] [F20, F22-OP2.3] Applies to elements that support or are part of an environmental separator. [F20-OS2.1, OS2.5] [F22-OS2.5] [F20, F22-OS2.3] Applies to elements that support or are part of an environmental separator. [F20, F22-OS3.1] Applies to floors and elements that support floors.
9.23.6.2.	Anchorage of Columns and Posts
(1)	[F22-OH1.1, OH1.2, OH1.3] Applies to elements that support or are part of an environmental separator. [F22-OH4] Applies to floors and elements that support floors. [F22-OP2.4, OP2.5] [F22-OP2.3] Applies to elements that support or are part of an environmental separator. [F22-OS2.4, OS2.5] [F22-OS2.3] Applies to elements that support or are part of an environmental separator. [F22-OS3.1] Applies to floors and elements that support floors. [F22-OS3.7] Applies to walls, and the elements that support walls, that contain doors or windows required for emergency egress.
(2)	[F22-OH1.1, OH1.2, OH1.3] Applies to elements that support or are part of an environmental separator. [F22-OH4] Applies to floors and elements that support floors. [F22-OP2.4, OP2.5] [F22-OP2.3] Applies to elements that support or are part of an environmental separator. [F22-OS2.4, OS2.5] [F22-OS2.3] Applies to elements that support or are part of an environmental separator. [F22-OS3.1] [F22-OS3.7] Applies to floors and elements that support floors.
9.23.6.3.	Anchorage of Smaller Buildings
(1)	[F22-OS2.3, OS2.5]
9.23.7.1.	Size of Sill Plates
(1)	[F20-OP2.1, OP2.5] [F22-OP2.4, OP2.5] [F20, F22-OP2.3] Applies to elements that support or are part of an environmental separator. [F20, F22-OH1.1, OH1.2, OH1.3] Applies to elements that support or are part of an environmental separator. [F22-OH4] Applies to floors and elements that support floors. [F22-OS1.2] Applies to assemblies required to provide fire resistance. [F20-OS2.1, OS2.5] [F22-OS2.5] [F20, F22-OS2.3] Applies to elements that support or are part of an environmental separator.

Acceptable Solution	Objectives and Functional Statements
(1) (Cont'd)	[F22-OS3.1] Applies to floors and elements that support floors. [F22-OS3.7] Applies to walls, and elements that support walls, that contain doors or windows required for emergency egress.
9.23.7.2.	Levelling of Sill Plates
(1)	[F20-OP2.1, OP2.5] [F22-OP2.4, OP2.5] [F20, F22-OP2.3] Applies to elements that support or are part of an environmental separator. [F20, F22-OH1.1, OH1.2, OH1.3] Applies to elements that support or are part of an environmental separator. [F20, F22-OH4] Applies to floors and elements that support floors. [F20-OS2.1, OS2.5] [F22-OS2.4, OS2.5] [F20, F22-OS2.3] Applies to elements that support or are part of an environmental separator. [F20, F22-OS3.1] Applies to floors and elements that support floors.
(2)	
9.23.8.1.	Bearing for Beams
(1)	[F20-OP2.1, OP2.5] [F22-OP2.4, OP2.5] [F20, F22-OP2.3] Applies to elements that support or are part of an environmental separator. [F20, F22-OH1.1, OH1.2, OH1.3] Applies to elements that support or are part of an environmental separator. [F22-OH4] Applies to floors and elements that support floors. [F22-OS1.2] Applies to assemblies required to provide fire resistance. [F20-OS2.1, OS2.5] [F22-OS2.5] [F20, F22-OS2.3] Applies to elements that support or are part of an environmental separator. [F22-OS3.1] Applies to floors and elements that support floors. [F22-OS3.7] Applies to walls, and elements that support walls, that contain doors or windows required for emergency egress.
9.23.8.2.	Priming of Steel Beams
(1)	[F80-OH1.1, OH1.2, OH1.3] Applies to elements that support or are part of an environmental separator. [F80-OH4] Applies to floors and elements that support floors. [F80-OP2.1, OP2.4] [F80-OP2.3] Applies to elements that support or are part of an environmental separator. [F80-OS1.2] Applies to assemblies required to provide fire resistance. [F80-OS2.1] [F80-OS2.3] Applies to floors and elements that support floors. [F80-OS3.1] Applies to floors and elements that support floors.
9.23.8.3.	Built-up Wood Beams
(1)	[F20-OP2.1] [F20-OS2.1]
(2)	[F20-OP2.1] [F20-OS2.1]
(3)	[F20-OP2.1] [F20-OS2.1]
(4)	[F20-OP2.1] [F20-OS2.1]
(5)	[F20-OP2.1] [F20-OS2.1]
(6)	[F20-OP2.1] [F20-OS2.1]
(7)	[F20-OP2.1] [F20-OS2.1]
(8)	[F20-OP2.1] [F20-OS2.1]

Acceptable Solution	Objectives and Functional Statements
9.23.9.1.	End Bearing for Joists
(1)	[F20-OP2.1, OP2.5] [F22-OP2.4, OP2.5] [F20, F22-OP2.3] Applies to elements that support or are part of an environmental separator. [F20, F22-OH1.1, OH1.2, OH1.3] Applies to elements that support or are part of an environmental separator. [F22-OH4] [F20, F22-OS1.2] Applies to assemblies required to provide fire resistance. [F20-OS2.1, OS2.5] [F22-OS2.5] [F20, F22-OS2.3] Applies to elements that support or are part of an environmental separator. [F22-OS3.1]
(2)	[F20-OP2.1, OP2.5] [F22-OP2.4, OP2.5] [F20, F22-OP2.3] Applies to elements that support or are part of an environmental separator. [F20, F22-OH1.1, OH1.2, OH1.3] Applies to elements that support or are part of an environmental separator. [F22-OH4] [F20, F22-OS1.2] Applies to assemblies required to provide fire resistance. [F20-OS2.1, OS2.5] [F22-OS2.5] [F20, F22-OS2.3] Applies to elements that support or are part of an environmental separator. [F22-OS3.1]
9.23.9.2.	Joists Supported by Beams
(1)	[F20-OP2.1, OP2.5] [F22-OP2.4, OP2.5] [F20, F22-OP2.3] Applies to elements that support or are part of an environmental separator. [F20, F22-OH1.1, OH1.2, OH1.3] Applies to elements that support or are part of an environmental separator. [F22-OH4] [F20, F22-OS1.2] Applies to assemblies required to provide fire resistance. [F20-OS2.1, OS2.5] [F22-OS2.5] [F20, F22-OS2.3] Applies to elements that support or are part of an environmental separator. [F22-OS3.1] [F22-OS3.7] Applies to walls, and elements that support walls, that contain doors or windows required for emergency egress.
(2)	[F20-OP2.1, OP2.5] [F22-OP2.4, OP2.5] [F20, F22-OP2.3] Applies to elements that support or are part of an environmental separator. [F20, F22-OH1.1, OH1.2, OH1.3] Applies to elements that support or are part of an environmental separator. [F22-OH4] [F20, F22-OS1.2] Applies to assemblies required to provide fire resistance. [F20-OS2.1, OS2.5] [F22-OS2.5] [F20, F22-OS2.3] Applies to elements that support or are part of an environmental separator. [F22-OS3.1] [F22-OS3.7] Applies to walls, and elements that support walls, that contain doors or windows required for emergency egress.
(3)	[F20-OP2.1, OP2.5] [F22-OP2.4, OP2.5] [F20, F22-OP2.3] Applies to elements that support or are part of an environmental separator. [F22-OH4] [F20, F22-OH1.1, OH1.2, OH1.3] Applies to elements that support or are part of an environmental separator. [F20, F22-OS1.2] Applies to assemblies required to provide fire resistance. [F20-OS2.1, OS2.5] [F22-OS2.5] [F20, F22-OS2.3] Applies to elements that support or are part of an environmental separator.

Acceptable Solution	Objectives and Functional Statements
(3) (Cont'd)	[F22-OS3.1] [F22-OS3.7] Applies to walls, and elements that support walls, that contain doors or windows required for emergency egress.
(4)	[F20-OP2.1, OP2.5] [F22-OP2.4, OP2.5] [F20, F22-OP2.3] Applies to elements that support or are part of an environmental separator. [F20, F22-OH1.1, OH1.2, OH1.3] Applies to elements that support or are part of an environmental separator. [F22-OH4] [F20, F22-OS1.2] Applies to assemblies required to provide fire resistance. [F20-OS2.1, OS2.5] [F22-OS2.5] [F20, F22-OS2.3] Applies to elements that support or are part of an environmental separator. [F22-OS3.1] [F22-OS3.7] Applies to walls, and elements that support walls, that contain doors or windows required for emergency egress.
(5)	[F20-OP2.1, OP2.5] [F22-OP2.4, OP2.5] [F20, F22-OP2.3] Applies to elements that support or are part of an environmental separator. [F20, F22-OH1.1, OH1.2, OH1.3] Applies to elements that support or are part of an environmental separator. [F22-OH4] [F20, F22-OS1.2] Applies to assemblies required to provide fire resistance. [F20-OS2.1, OS2.5] [F22-OS2.5] [F20, F22-OS2.3] Applies to elements that support or are part of an environmental separator. [F22-OS3.1] [F22-OS3.7] Applies to walls, and elements that support walls, that contain doors or windows required for emergency egress.
9.23.9.3.	Restraint of Joist Bottoms
(1)	[F20-OP2.1, OP2.5] [F22-OP2.4, OP2.5] [F20, F22-OP2.3] Applies to elements that support or are part of an environmental separator. [F20, F22-OH1.1, OH1.2, OH1.3] Applies to elements that support or are part of an environmental separator. [F22-OH4] [F20, F22-OS1.2] Applies to assemblies required to provide fire resistance. [F20-OS2.1, OS2.5] [F22-OS2.5] [F20, F22-OS2.3] Applies to elements that support or are part of an environmental separator. [F22-OS3.1] [F22-OS3.7] Applies to walls, and elements that support walls, that contain doors or windows required for emergency egress.
9.23.9.4.	Strapping and Bridging in Tables A-1 and A-2
(1)	[F20-OP2.1, OP2.5] [F22-OP2.4, OP2.5] [F20, F22-OP2.3] Applies to elements that support or are part of an environmental separator. [F20, F22-OH1.1, OH1.2, OH1.3] Applies to elements that support or are part of an environmental separator. [F22-OH4] [F20, F22-OS1.2] Applies to assemblies required to provide fire resistance. [F20-OS2.1, OS2.5] [F22-OS2.5] [F20, F22-OS2.3] Applies to elements that support or are part of an environmental separator. [F22-OS3.1] [F22-OS3.7] Applies to walls, and elements that support walls, that contain doors or windows required for emergency egress.
(2)	[F20-OP2.1, OP2.5] [F22-OP2.4, OP2.5] [F20, F22-OP2.3] Applies to elements that support or are part of an environmental separator.

Acceptable Solution	Objectives and Functional Statements
(2) (Cont'd)	[F20, F22-OH1.1, OH1.2, OH1.3] Applies to elements that support or are part of an environmental separator. [F22-OH4] [F20, F22-OS1.2] Applies to assemblies required to provide fire resistance. [F20-OS2.1, OS2.5] [F22-OS2.5] [F20, F22-OS2.3] Applies to elements that support or are part of an environmental separator. [F22-OS3.1] [F22-OS3.7] Applies to walls, and elements that support walls, that contain doors or windows required for emergency egress.
(3)	[F20-OP2.1, OP2.5] [F22-OP2.4, OP2.5] [F20, F22-OP2.3] Applies to elements that support or are part of an environmental separator. [F20, F22-OH1.1, OH1.2, OH1.3] Applies to elements that support or are part of an environmental separator. [F22-OH4] [F20, F22-OS1.2] Applies to assemblies required to provide fire resistance. [F20-OS2.1, OS2.5] [F22-OS2.5] [F20, F22-OS2.3] Applies to elements that support or are part of an environmental separator. [F22-OS3.1] [F22-OS3.7] Applies to walls, and elements that support walls, that contain doors or windows required for emergency egress.
(4)	[F20-OP2.1, OP2.5] [F22-OP2.4, OP2.5] [F20, F22-OP2.3] Applies to elements that support or are part of an environmental separator. [F20, F22-OH1.1, OH1.2, OH1.3] Applies to elements that support or are part of an environmental separator. [F22-OH4] [F20, F22-OS1.2] Applies to assemblies required to provide fire resistance. [F20-OS2.1, OS2.5] [F22-OS2.5] [F20, F22-OS2.3] Applies to elements that support or are part of an environmental separator. [F22-OS3.1] [F22-OS3.7] Applies to walls, and elements that support walls, that contain doors or windows required for emergency egress.
(5)	[F20-OP2.1, OP2.5] [F22-OP2.4, OP2.5] [F20, F22-OP2.3] Applies to elements that support or are part of an environmental separator. [F20, F22-OH1.1, OH1.2, OH1.3] Applies to elements that support or are part of an environmental separator. [F22-OH4] [F20, F22-OS1.2] Applies to assemblies required to provide fire resistance. [F20-OS2.1, OS2.5] [F22-OS2.5] [F20, F22-OS2.3] Applies to elements that support or are part of an environmental separator. [F22-OS3.1] [F22-OS3.7] Applies to walls, and elements that support walls, that contain doors or windows required for emergency egress.
(6)	[F20-OP2.1, OP2.5] [F22-OP2.4, OP2.5] [F20, F22-OP2.3] Applies to elements that support or are part of an environmental separator. [F20, F22-OH1.1, OH1.2, OH1.3] Applies to elements that support or are part of an environmental separator. [F22-OH4] [F20, F22-OS1.2] Applies to assemblies required to provide fire resistance. [F20-OS2.1, OS2.5] [F22-OS2.5] [F20, F22-OS2.3] Applies to elements that support or are part of an environmental separator.

Acceptable Solution	Objectives and Functional Statements
(6) (Cont'd)	[F22-OS3.1] [F22-OS3.7] Applies to walls, and elements that support walls, that contain doors or windows required for emergency egress.
9.23.9.5.	Header Joists
(1)	[F20-OP2.1, OP2.5] [F22-OP2.4, OP2.5] [F20, F22-OP2.3] Applies to elements that support or are part of an environmental separator. [F20, F22-OH1.1, OH1.2, OH1.3] Applies to elements that support or are part of an environmental separator. [F22-OH4] [F20, F22-OS1.2] Applies to assemblies required to provide fire resistance. [F20-OS2.1, OS2.5] [F22-OS2.5] [F20, F22-OS2.3] Applies to elements that support or are part of an environmental separator. [F22-OS3.1] [F22-OS3.7] Applies to walls, and elements that support walls, that contain doors or windows required for emergency egress.
(2)	
9.23.9.6.	Trimmer Joists
(1)	[F20-OP2.1, OP2.5] [F22-OP2.4, OP2.5] [F20, F22-OP2.3] Applies to elements that support or are part of an environmental separator. [F20, F22-OH1.1, OH1.2, OH1.3] Applies to elements that support or are part of an environmental separator. [F22-OH4] [F20, F22-OS1.2] Applies to assemblies required to provide fire resistance. [F20-OS2.1, OS2.5] [F22-OS2.5] [F20, F22-OS2.3] Applies to elements that support or are part of an environmental separator. [F22-OS3.1] [F22-OS3.7] Applies to walls, and elements that support walls, that contain doors or windows required for emergency egress.
(2)	
9.23.9.7.	Support of Tail and Header Joists
(1)	[F20-OP2.1, OP2.5] [F22-OP2.4, OP2.5] [F20, F22-OP2.3] Applies to elements that support or are part of an environmental separator. [F20, F22-OH1.1, OH1.2, OH1.3] Applies to elements that support or are part of an environmental separator. [F22-OH4] [F20, F22-OS1.2] Applies to assemblies required to provide fire resistance. [F20-OS2.1, OS2.5] [F22-OS2.5] [F20, F22-OS2.3] Applies to elements that support or are part of an environmental separator. [F22-OS3.1] [F22-OS3.7] Applies to walls, and elements that support walls, that contain doors or windows required for emergency egress.
9.23.9.8.	Support of Walls
(1)	[F20-OP2.1, OP2.5] [F22-OP2.4, OP2.5] [F20, F22-OP2.3] Applies to elements that support or are part of an environmental separator. [F20, F22-OH1.1, OH1.2, OH1.3] Applies to elements that support or are part of an environmental separator. [F22-OH4] [F20, F22-OS1.2] Applies to assemblies required to provide fire resistance. [F20-OS2.1, OS2.5] [F22-OS2.5] [F20, F22-OS2.3] Applies to elements that support or are part of an environmental separator.

Acceptable Solution	Objectives and Functional Statements
(1) (Cont'd)	[F22-OS3.1] [F22-OS3.7] Applies to walls, and elements that support walls, that contain doors or windows required for emergency egress.
(2)	[F20-OP2.1, OP2.5] [F22-OP2.4, OP2.5] [F20, F22-OP2.3] Applies to elements that support or are part of an environmental separator. [F20, F22-OH1.1, OH1.2, OH1.3] Applies to elements that support or are part of an environmental separator. [F22-OH4] [F20, F22-OS1.2] Applies to assemblies required to provide fire resistance. [F20-OS2.1, OS2.5] [F22-OS2.5] [F20, F22-OS2.3] Applies to elements that support or are part of an environmental separator. [F22-OS3.1] [F22-OS3.7] Applies to walls, and elements that support walls, that contain doors or windows required for emergency egress.
(3)	
(4)	[F20-OP2.1, OP2.5] [F22-OP2.4, OP2.5] [F20, F22-OP2.3] Applies to elements that support or are part of an environmental separator. [F20, F22-OH1.1, OH1.2, OH1.3] Applies to elements that support or are part of an environmental separator. [F22-OH4] [F20, F22-OS1.2] Applies to assemblies required to provide fire resistance. [F20-OS2.1, OS2.5] [F22-OS2.5] [F20, F22-OS2.3] Applies to elements that support or are part of an environmental separator. [F22-OS3.1] [F22-OS3.7] Applies to walls, and elements that support walls, that contain doors or windows required for emergency egress.
(5)	[F20-OP2.1, OP2.5] [F22-OP2.4, OP2.5] [F20, F22-OP2.3] Applies to elements that support or are part of an environmental separator. [F20, F22-OH1.1, OH1.2, OH1.3] Applies to elements that support or are part of an environmental separator. [F22-OH4] [F20, F22-OS1.2] Applies to assemblies required to provide fire resistance. [F20-OS2.1, OS2.5] [F22-OS2.5] [F20, F22-OS2.3] Applies to elements that support or are part of an environmental separator. [F22-OS3.1] [F22-OS3.7] Applies to walls, and elements that support walls, that contain doors or windows required for emergency egress.
9.23.9.9.	Cantilevered Floor Joists
(1)	[F20-OP2.1, OP2.5] [F22-OP2.4, OP2.5] [F20, F22-OP2.3] Applies to elements that support or are part of an environmental separator. [F20, F22-OH1.1, OH1.2, OH1.3] Applies to elements that support or are part of an environmental separator. [F22-OH4] [F20, F22-OS1.2] Applies to assemblies required to provide fire resistance. [F20-OS2.1, OS2.5] [F22-OS2.5] [F20, F22-OS2.3] Applies to elements that support or are part of an environmental separator. [F22-OS3.1] [F22-OS3.7] Applies to walls, and elements that support walls, that contain doors or windows required for emergency egress.
(2)	[F20-OP2.1, OP2.5] [F22-OP2.4, OP2.5] [F20, F22-OP2.3] Applies to elements that support or are part of an environmental separator.

Acceptable Solution	Objectives and Functional Statements
(2) (Cont'd)	[F20, F22-OH1.1, OH1.2, OH1.3] Applies to elements that support or are part of an environmental separator. [F22-OH4] [F20, F22-OS1.2] Applies to assemblies required to provide fire resistance. [F20-OS2.1, OS2.5] [F22-OS2.5] [F20, F22-OS2.3] Applies to elements that support or are part of an environmental separator. [F22-OS3.1] [F22-OS3.7] Applies to walls, and elements that support walls, that contain doors or windows required for emergency egress.
(3)	[F20-OP2.1, OP2.5] [F22-OP2.4, OP2.5] [F20, F22-OP2.3] Applies to elements that support or are part of an environmental separator. [F20, F22-OH1.1, OH1.2, OH1.3] Applies to elements that support or are part of an environmental separator. [F22-OH4] [F20, F22-OS1.2] Applies to assemblies required to provide fire resistance. [F20-OS2.1, OS2.5] [F22-OS2.5] [F20, F22-OS2.3] Applies to elements that support or are part of an environmental separator. [F22-OS3.1] [F22-OS3.7] Applies to walls, and elements that support walls, that contain doors or windows required for emergency egress.
9.23.10.1.	Stud Size and Spacing
(1)	[F20-OP2.1, OP2.5] [F22-OP2.4, OP2.5] [F20, F22-OP2.3] Applies to elements that support or are part of an environmental separator. [F20, F22-OH1.1, OH1.2, OH1.3] Applies to elements that support or are part of an environmental separator. [F22-OH4] Applies to floors and elements that support floors. [F20, F22-OS1.2] Applies to assemblies required to provide fire resistance. [F20-OS2.1, OS2.5] [F22-OS2.5] [F20, F22-OS2.3] Applies to elements that support or are part of an environmental separator. [F22-OS3.1] Applies to floors and elements that support floors. [F22-OS3.7] Applies to walls, and elements that support walls, that contain doors or windows required for emergency egress.
(2)	[F20-OP2.1, OP2.5] [F22-OP2.4, OP2.5] [F20, F22-OP2.3] Applies to elements that support or are part of an environmental separator. [F20, F22-OH1.1, OH1.2, OH1.3] Applies to elements that support or are part of an environmental separator. [F22-OH4] Applies to floors and elements that support floors. [F20, F22-OS1.2] Applies to assemblies required to provide fire resistance. [F20-OS2.1, OS2.5] [F22-OS2.5] [F20, F22-OS2.3] Applies to elements that support or are part of an environmental separator. [F22-OS3.1] Applies to floors and elements that support floors. [F22-OS3.7] Applies to walls, and elements that support walls, that contain doors or windows required for emergency egress.
9.23.10.2.	Bracing and Lateral Support
(1)	[F20-OP2.1, OP2.3, OP2.5] [F22-OP2.3, OP2.4, OP2.5] [F20, F22-OH1.1, OH1.2, OH1.3] [F20, F22-OH4] Applies to walls that support floors. [F20, F22-OS1.2] Applies to assemblies required to provide fire resistance. [F20-OS2.1, OS2.3, OS2.5] [F22-OS2.3, OS2.4, OS2.5] [F22-OS3.1] Applies to walls that support floors. [F22-OS3.7] Applies to walls that contain doors or windows required for emergency egress.

Acceptable Solution	Objectives and Functional Statements
(2)	[F20-OP2.1, OP2.3, OP2.5] [F22-OP2.3, OP2.4, OP2.5] [F20, F22-OH1.1, OH1.2, OH1.3] [F20, F22-OH4] Applies to walls that support floors. [F20, F22-OS1.2] Applies to assemblies required to provide fire resistance. [F20-OS2.1, OS2.3, OS2.5] [F22-OS2.3, OS2.4, OS2.5] [F22-OS3.1] Applies to walls that support floors. [F22-OS3.7] Applies to walls that contain doors or windows required for emergency egress.
(3)	[F20-OP2.1, OP2.3, OP2.5] [F22-OP2.3, OP2.4, OP2.5] [F20, F22-OH1.1, OH1.2, OH1.3] [F20, F22-OH4] Applies to walls that support floors. [F20, F22-OS1.2] Applies to assemblies required to provide fire resistance. [F20-OS2.1, OS2.3, OS2.5] [F22-OS2.3, OS2.4, OS2.5] [F22-OS3.1] Applies to walls that support floors. [F22-OS3.7] Applies to walls that contain doors or windows required for emergency egress.
(4)	[F20-OP2.1, OP2.3, OP2.5] [F22-OP2.3, OP2.4, OP2.5] [F20, F22-OH1.1, OH1.2, OH1.3] [F20, F22-OH4] Applies to walls that support floors. [F20, F22-OS1.2] Applies to assemblies required to provide fire resistance. [F20-OS2.1, OS2.3, OS2.5] [F22-OS2.3, OS2.4, OS2.5] [F22-OS3.1] Applies to walls that support floors. [F22-OS3.7] Applies to walls that contain doors or windows required for emergency egress.
(5)	[F20-OP2.1, OP2.5] [F22-OP2.4, OP2.5] [F20, F22-OP2.3] Applies to walls that support or are part of an environmental separator. [F20, F22-OH1.1, OH1.2, OH1.3] Applies to walls that support or are part of an environmental separator. [F22-OH4] Applies to walls that support floors. [F20, F22-OS1.2] Applies to assemblies required to provide fire resistance. [F20-OS2.1, OS2.5] [F22-OS2.5] [F20, F22-OS2.3] Applies to walls that support or are part of an environmental separator. [F22-OS3.1] Applies to walls that support floors. [F22-OS3.7] Applies to walls that contain doors or windows required for emergency egress.
9.23.10.3.	Orientation of Studs
(1)	[F20-OP2.1, OP2.5] [F22-OP2.4, OP2.5] [F20, F22-OP2.3] Applies to elements that support or are part of an environmental separator. [F20, F22-OH1.1, OH1.2, OH1.3] Applies to elements that support or are part of an environmental separator. [F22-OH4] Applies to floors and elements that support floors. [F20-OS2.1, OS2.5] [F22-OS2.5] [F20, F22-OS2.3] Applies to elements that support or are part of an environmental separator. [F22-OS3.1] Applies to floors and elements that support floors. [F22-OS3.7] Applies to walls, and elements that support walls, that contain doors or windows required for emergency egress.
(2)	
(3)	[F20-OP2.1, OP2.5] [F22-OP2.4, OP2.5] [F20, F22-OP2.3] Applies to elements that support or are part of an environmental separator. [F20, F22-OH1.1, OH1.2, OH1.3] Applies to elements that support or are part of an environmental separator. [F20, F22-OS1.2] Applies to assemblies required to provide fire resistance. [F20-OS2.1, OS2.5] [F22-OS2.5] [F20, F22-OS2.3] Applies to elements that support or are part of an environmental separator.

Acceptable Solution	Objectives and Functional Statements
(3) (Cont'd)	[F22-OS3.1] Applies to floors and elements that support floors. [F22-OS3.7] Applies to walls, and elements that support walls, that contain doors or windows required for emergency egress.
9.23.10.4.	Continuity of Studs
(1)	[F20-OP2.1, OP2.5] [F22-OP2.4, OP2.5] [F20, F22-OP2.3] Applies to elements that support or are part of an environmental separator. [F20, F22-OH1.1, OH1.2, OH1.3] Applies to elements that support or are part of an environmental separator. [F22-OH4] Applies to floors and elements that support floors. [F20, F22-OS1.2] Applies to assemblies required to provide fire resistance. [F20-OS2.1, OS2.5] [F22-OS2.5] [F20, F22-OS2.3] Applies to elements that support or are part of an environmental separator. [F22-OS3.1] Applies to floors and elements that support floors. [F22-OS3.7] Applies to walls, and elements that support walls, that contain doors or windows required for emergency egress.
9.23.10.5.	Support for Cladding Materials
(1)	[F20-OP2.1, OP2.5] [F22-OP2.4, OP2.5] [F20, F22-OP2.3] Applies to elements that support or are part of an environmental separator. [F20, F22-OH1.1, OH1.2, OH1.3] Applies to elements that support or are part of an environmental separator. [F22-OH4] Applies to floors and elements that support floors. [F20, F22-OS1.2] Applies to assemblies required to provide fire resistance. [F22-OS2.1, OS2.5] [F22-OS2.5] [F20, F22-OS2.3] Applies to elements that support or are part of an environmental separator. [F22-OS3.1] Applies to floors and elements that support floors. [F22-OS3.7] Applies to walls, and elements that support walls, that contain doors or windows required for emergency egress.
(2)	[F20-OP2.1, OP2.5] [F22-OP2.4, OP2.5] [F20, F22-OP2.3] Applies to elements that support or are part of an environmental separator. [F20, F22-OH1.1, OH1.2, OH1.3] Applies to elements that support or are part of an environmental separator. [F22-OH4] Applies to floors and elements that support floors. [F20, F22-OS1.2] Applies to assemblies required to provide fire resistance. [F22-OS2.1, OS2.5] [F22-OS2.5] [F20, F22-OS2.3] Applies to elements that support or are part of an environmental separator. [F22-OS3.1] Applies to floors and elements that support floors. [F22-OS3.7] Applies to walls, and elements that support walls, that contain doors or windows required for emergency egress.
9.23.10.6.	Studs at Sides of Openings
(1)	[F20-OP2.1, OP2.5] [F22-OP2.4, OP2.5] [F20, F22-OP2.3] Applies to elements that support or are part of an environmental separator. [F20, F22-OH1.1, OH1.2, OH1.3] Applies to elements that support or are part of an environmental separator. [F22-OH4] Applies to floors and elements that support floors. [F20, F22-OS1.2] Applies to assemblies required to provide fire resistance. [F22-OS2.1, OS2.5] [F22-OS2.5] [F20, F22-OS2.3] Applies to elements that support or are part of an environmental separator. [F22-OS3.1] Applies to floors and elements that support floors. [F22-OS3.7] Applies to walls, and elements that support walls, that contain doors or windows required for emergency egress.
(2)	(b) [F20, F22-OH1.1, OH1.2, OH1.3] Applies to elements that support or are part of an environmental separator. (b) [F20, F22-OH4] Applies to elements that support floors

Acceptable Solution	Objectives and Functional Statements
(2) (Cont'd)	(b) [F20, F22-OS1.2] Applies to assemblies required to provide fire resistance. (b) [F20, F22-OS3.1] Applies floors and elements that support floors (b) [F20, F22-OS3.7] Applies walls, and elements that support walls, that contain doors or windows required for emergency egress. [F20-OP2.1] (b) [F20-OP2.5] (b) [F20-OP2.4, OP2.5] (b) [F20, F22-OP2.3] Applies to elements that support or are part of an environmental separator. F20-OS2.1] Applies to floors and elements that support floors. (b) [F20, F22-OS2.5] [F20, F22-OS2.3] Applies to elements that support or are part of an environmental separator.
9.23.10.7.	Stud Posts Built into Walls
(1)	
(2)	[F20-OP2.1, OP2.5] [F22-OP2.4, OP2.5] [F20, F22-OP2.3] Applies to elements that support or are part of an environmental separator. [F20, F22-OH1.1, OH1.2, OH1.3] Applies to elements that support or are part of an environmental separator. [F22-OH4] Applies to floors and elements that support floors. [F20, F22-OS1.2] Applies to assemblies required to provide fire resistance. [F22-OS2.1, OS2.5] [F22-OS2.5] [F20, F22-OS2.3] Applies to elements that support or are part of an environmental separator. [F22-OS3.1] Applies to floors and elements that support floors. [F22-OS3.7] Applies to walls, and elements that support walls, that contain doors or windows required for emergency egress.
(3)	[F20-OP2.1, OP2.5] [F22-OP2.4, OP2.5] [F20, F22-OP2.3] Applies to elements that support or are part of an environmental separator. [F20, F22-OH1.1, OH1.2, OH1.3] Applies to elements that support or are part of an environmental separator. [F22-OH4] Applies to floors and roofs and elements that support floors and roofs. [F20, F22-OS1.2] Applies to assemblies required to provide fire resistance. [F22-OS2.1, OS2.5] [F22-OS2.5] [F20, F22-OS2.3] Applies to elements that support or are part of an environmental separator. [F22-OS3.1] Applies to floors and roofs and elements that support floors and roofs. [F22-OS3.7] Applies to walls, and elements that support walls, that contain doors or windows required for emergency egress.
9.23.11.1.	Size of Wall Plates
(1)	[F20-OP2.1, OP2.5] [F22-OP2.4, OP2.5] [F20, F22-OP2.3] Applies to elements that support or are part of an environmental separator. [F20, F22-OH1.1, OH1.2, OH1.3] Applies to elements that support or are part of an environmental separator. [F22-OH4] Applies to floors and elements that support floors. [F20, F22-OS1.2] Applies to assemblies required to provide fire resistance. [F20-OS2.1, OS2.5] [F22-OS2.5] [F20, F22-OS2.3] Applies to elements that support or are part of an environmental separator. [F22-OS3.1] Applies to floors and elements that support floors. [F22-OS3.7] Applies to walls, and elements that support walls, that contain doors or windows required for emergency egress.
(2)	[F20-OP2.1, OP2.5] [F22-OP2.4, OP2.5] [F20, F22-OP2.3] Applies to elements that support or are part of an environmental separator. [F20, F22-OH1.1, OH1.2, OH1.3] Applies to elements that support or are part of an environmental separator. [F22-OH4] Applies to floors and elements that support floors. [F20, F22-OS1.2] Applies to assemblies required to provide fire resistance.

Acceptable Solution	Objectives and Functional Statements
(2) (Cont'd)	[F20-OS2.1, OS2.5] [F22-OS2.5] [F20, F22-OS2.3] Applies to elements that support or are part of an environmental separator. [F22-OS3.1] Applies to floors and elements that support floors. [F22-OS3.7] Applies to walls, and elements that support walls, that contain doors or windows required for emergency egress.
9.23.11.2.	Bottom Wall Plates
(1)	[F20-OP2.1, OP2.5] [F22-OP2.4, OP2.5] [F20, F22-OP2.3] Applies to elements that support or are part of an environmental separator. [F20, F22-OH1.1, OH1.2, OH1.3] Applies to elements that support or are part of an environmental separator. [F22-OH4] Applies to floors and elements that support floors. [F20, F22-OS1.2] Applies to assemblies required to provide fire resistance. [F20-OS2.1, OS2.5] [F22-OS2.5] [F20, F22-OS2.3] Applies to elements that support or are part of an environmental separator. [F22-OS3.1] Applies to floors and elements that support floors. [F22-OS3.7] Applies to walls, and elements that support walls, that contain doors or windows required for emergency egress.
(2)	[F20-OP2.1, OP2.3, OP2.5] [F22-OP2.3, OP2.4, OP2.5] [F20, F22-OH1.1, OH1.2, OH1.3] [F22-OH4] Applies to floors and elements that support floors. [F20, F22-OS1.2] Applies to assemblies required to provide fire resistance. [F20-OS2.1, OS2.3, OS2.5] [F22-OS2.3, OS2.5] [F22-OS3.1] Applies to floors and elements that support floors. [F22-OS3.7] Applies to walls, and elements that support walls, that contain doors or windows required for emergency egress.
9.23.11.3.	Top Plates
(1)	[F20-OP2.1, OP2.5] [F22-OP2.4, OP2.5] [F20, F22-OP2.3] Applies to elements that support or are part of an environmental separator. [F20, F22-OH1.1, OH1.2, OH1.3] Applies to elements that support or are part of an environmental separator. [F22-OH4] Applies to floors and elements that support floors. [F20, F22-OS1.2] Applies to assemblies required to provide fire resistance. [F20-OS2.1, OS2.5] [F22-OS2.5] [F20, F22-OS2.3] Applies to elements that support or are part of an environmental separator. [F22-OS3.1] Applies to floors and elements that support floors. [F22-OS3.7] Applies to walls, and elements that support walls, that contain doors or windows required for emergency egress.
(2)	[F20-OP2.1, OP2.5] [F22-OP2.4, OP2.5] [F20, F22-OP2.3] Applies to elements that support or are part of an environmental separator. [F20, F22-OH1.1, OH1.2, OH1.3] Applies to elements that support or are part of an environmental separator. [F22-OH4] Applies to floors and elements that support floors. [F20, F22-OS1.2] Applies to assemblies required to provide fire resistance. [F20-OS2.1, OS2.5] [F22-OS2.5] [F20, F22-OS2.3] Applies to elements that support or are part of an environmental separator. [F22-OS3.1] Applies to floors and elements that support floors. [F22-OS3.7] Applies to walls, and elements that support walls, that contain doors or windows required for emergency egress.
(3)	[F20-OP2.1, OP2.5] [F22-OP2.4, OP2.5] [F20, F22-OP2.3] Applies to elements that support or are part of an environmental separator. [F20, F22-OH1.1, OH1.2, OH1.3] Applies to elements that support or are part of an environmental separator.

Acceptable Solution	Objectives and Functional Statements
(3) (Cont'd)	[F22-OH4] Applies to floors and elements that support floors. [F20, F22-OS1.2] Applies to assemblies required to provide fire resistance. [F20-OS2.1, OS2.5] [F22-OS2.5] [F20, F22-OS2.3] Applies to elements that support or are part of an environmental separator. [F22-OS3.1] Applies to floors and elements that support floors. [F22-OS3.7] Applies to walls, and elements that support walls, that contain doors or windows required for emergency egress.
(4)	[F20-OP2.1, OP2.5] [F22-OP2.4, OP2.5] [F20, F22-OP2.3] Applies to elements that support or are part of an environmental separator. [F20, F22-OH1.1, OH1.2, OH1.3] Applies to elements that support or are part of an environmental separator. [F22-OH4] Applies to floors and elements that support floors. [F20, F22-OS1.2] Applies to assemblies required to provide fire resistance. [F20-OS2.1, OS2.5] [F22-OS2.5] [F20, F22-OS2.3] Applies to elements that support or are part of an environmental separator. [F22-OS3.1] Applies to floors and elements that support floors. [F22-OS3.7] Applies to walls, and elements that support walls, that contain doors or windows required for emergency egress.
9.23.11.4.	Joints in Top Plates
(1)	[F20-OP2.1, OP2.5] [F22-OP2.4, OP2.5] [F20, F22-OP2.3] Applies to elements that support or are part of an environmental separator. [F20, F22-OH1.1, OH1.2, OH1.3] Applies to elements that support or are part of an environmental separator. [F22-OH4] Applies to floors and elements that support floors. [F20, F22-OS1.2] Applies to assemblies required to provide fire resistance. [F20-OS2.1, OS2.5] [F22-OS2.5] [F20, F22-OS2.3] Applies to elements that support or are part of an environmental separator. [F22-OS3.1] Applies to floors and elements that support floors. [F22-OS3.7] Applies to walls, and elements that support walls, that contain doors or windows required for emergency egress.
(2)	[F20-OP2.1, OP2.5] [F22-OP2.4, OP2.5] [F20, F22-OP2.3] Applies to elements that support or are part of an environmental separator. [F20, F22-OH1.1, OH1.2, OH1.3] Applies to elements that support or are part of an environmental separator. [F22-OH4] Applies to floors and elements that support floors. [F20, F22-OS1.2] Applies to assemblies required to provide fire resistance. [F20-OS2.1, OS2.5] [F22-OS2.5] [F20, F22-OS2.3] Applies to elements that support or are part of an environmental separator. [F22-OS3.1] Applies to floors and elements that support floors. [F22-OS3.7] Applies to walls, and elements that support walls, that contain doors or windows required for emergency egress.
(3)	[F20-OP2.1, OP2.5] [F22-OP2.4, OP2.5] [F20, F22-OP2.3] Applies to elements that support or are part of an environmental separator. [F20, F22-OH1.1, OH1.2, OH1.3] Applies to elements that support or are part of an environmental separator. [F22-OH4] Applies to floors and elements that support floors. [F20, F22-OS1.2] Applies to assemblies required to provide fire resistance. [F20-OS2.1, OS2.5] [F22-OS2.5] [F20, F22-OS2.3] Applies to elements that support or are part of an environmental separator.

Acceptable Solution	Objectives and Functional Statements
(3) (Cont'd)	[F22-OS3.1] Applies to floors and elements that support floors. [F22-OS3.7] Applies to walls, and elements that support walls, that contain doors or windows required for emergency egress.
(4)	[F20-OP2.1, OP2.5] [F22-OP2.4, OP2.5] [F20, F22-OP2.3] Applies to elements that support or are part of an environmental separator. [F20, F22-OH1.1, OH1.2, OH1.3] Applies to elements that support or are part of an environmental separator. [F22-OH4] Applies to floors and elements that support floors. [F20, F22-OS1.2] Applies to assemblies required to provide fire resistance. [F20-OS2.1, OS2.5] [F22-OS2.5] [F20, F22-OS2.3] Applies to elements that support or are part of an environmental separator. [F22-OS3.1] Applies to floors and elements that support floors. [F22-OS3.7] Applies to walls, and elements that support walls, that contain doors or windows required for emergency egress.
9.23.12.1.	Openings in Non-Loadbearing Walls
(1)	[F20-OP2.1, OP2.5] [F22-OP2.4, OP2.5] [F20, F22-OP2.3] Applies to elements that support or are part of an environmental separator. [F20, F22-OH1.1, OH1.2, OH1.3] Applies to elements that support or are part of an environmental separator. [F20-OS2.1, OS2.5] [F22-OS2.5] [F20, F22-OS2.3] Applies to elements that support or are part of an environmental separator. [F22-OS3.1] Applies to floors and elements that support floors. [F22-OS3.7] Applies to walls, and elements that support walls, that contain doors or windows required for emergency egress.
(2)	[F20, F22-OS1.2]
9.23.12.2.	Openings in Loadbearing Walls
(1)	[F20-OP2.1, OP2.5] [F22-OP2.4, OP2.5] [F20, F22-OP2.3] Applies to elements that support or are part of an environmental separator. [F20, F22-OH1.1, OH1.2, OH1.3] Applies to elements that support or are part of an environmental separator. [F22-OH4] Applies to floors and elements that support floors. [F20, F22-OS1.2] Applies to assemblies required to provide fire resistance. [F20-OS2.1, OS2.5] [F22-OS2.5] [F20, F22-OS2.3] Applies to elements that support or are part of an environmental separator. [F22-OS3.1] Applies to floors and elements that support floors. [F22-OS3.7] Applies to walls, and elements that support walls, that contain doors or windows required for emergency egress.
(2)	[F20-OP2.1, OP2.5] [F22-OP2.4, OP2.5] [F20, F22-OP2.3] Applies to elements that support or are part of an environmental separator. [F20, F22-OH1.1, OH1.2, OH1.3] Applies to elements that support or are part of an environmental separator. [F22-OH4] Applies to floors and elements that support floors. [F20, F22-OS1.2] Applies to assemblies required to provide fire resistance. [F20-OS2.1, OS2.5] [F22-OS2.5] [F20, F22-OS2.3] Applies to elements that support or are part of an environmental separator. [F22-OS3.1] Applies to floors and elements that support floors. [F22-OS3.7] Applies to walls, and elements that support walls, that contain doors or windows required for emergency egress.
(3)	

Acceptable Solution	Objectives and Functional Statements
9.23.12.3.	Lintel Spans and Sizes
(1)	[F20-OP2.1, OP2.5] [F22-OP2.4, OP2.5] [F20, F22-OP2.3] Applies to elements that support or are part of an environmental separator. [F20, F22-OH1.1, OH1.2, OH1.3] Applies to elements that support or are part of an environmental separator. [F22-OH4] Applies to floors and elements that support floors. [F20, F22-OS1.2] Applies to assemblies required to provide fire resistance. [F20-OS2.1, OS2.5] [F22-OS2.5] [F20, F22-OS2.3] Applies to elements that support or are part of an environmental separator. [F22-OS3.1] Applies to floors and elements that support floors. [F22-OS3.7] Applies to walls, and elements that support walls, that contain doors or windows required for emergency egress.
(2)	[F20-OP2.1, OP2.5] [F22-OP2.4, OP2.5] [F20, F22-OP2.3] Applies to elements that support or are part of an environmental separator. [F20, F22-OH1.1, OH1.2, OH1.3] Applies to elements that support or are part of an environmental separator. [F22-OH4] Applies to floors and elements that support floors. [F20, F22-OS1.2] Applies to assemblies required to provide fire resistance. [F20-OS2.1, OS2.5] [F22-OS2.5] [F20, F22-OS2.3] Applies to elements that support or are part of an environmental separator. [F22-OS3.1] Applies to floors and elements that support floors. [F22-OS3.7] Applies to walls, and elements that support walls, that contain doors or windows required for emergency egress.
(3)	[F20-OP2.1, OP2.5] [F22-OP2.4, OP2.5] [F20, F22-OP2.3] Applies to elements that support or are part of an environmental separator. [F20, F22-OH1.1, OH1.2, OH1.3] Applies to elements that support or are part of an environmental separator. [F22-OH4] Applies to floors and elements that support floors. [F20, F22-OS1.2] Applies to assemblies required to provide fire resistance. [F20-OS2.1, OS2.5] [F22-OS2.5] [F20, F22-OS2.3] Applies to elements that support or are part of an environmental separator. [F22-OS3.1] Applies to floors and elements that support floors. [F22-OS3.7] Applies to walls, and elements that support walls, that contain doors or windows required for emergency egress.
9.23.13.1.	Continuity of Rafters and Joists
(1)	[F20-OP2.1, OP2.5] [F22-OP2.5] [F20, F22-OP2.3] Applies to elements that support or are part of an environmental separator. [F20-OS2.1, OS2.5] [F22-OS2.5] [F20, F22-OS1.3] Applies to elements that support or are part of an environmental separator. [F20, F22-OH1.1, OH1.2, OH1.3] Applies to elements that support or are part of an environmental separator. [F20, F22-OS1.2] Applies to assemblies required to provide fire resistance.
9.23.13.2.	Framing around Openings
(1)	[F20-OP2.1, OP2.5] [F22-OP2.5] [F20, F22-OP2.3] Applies to elements that support or are part of an environmental separator. [F20, F22-OH1.1, OH1.2, OH1.3] Applies to elements that support or are part of an environmental separator. [F20-OS2.1, OS2.5] [F22-OS2.5] [F20, F22-OS2.3] Applies to elements that support or are part of an environmental separator. [F20, F22-OS1.2] Applies to assemblies required to provide fire resistance.

Acceptable Solution	Objectives and Functional Statements
9.23.13.3.	End Bearing Length
(1)	[F20-OP2.1, OP2.5] [F22-OP2.5] [F20, F22-OP2.3] Applies to elements that support or are part of an environmental separator. [F20, F22-OH1.1, OH1.2, OH1.3] Applies to elements that support or are part of an environmental separator. [F20-OS2.1, OS2.5] [F22-OS2.5] [F20, F22-OS2.3] Applies to elements that support or are part of an environmental separator. [F20, F22-OS1.2] Applies to assemblies required to provide fire resistance.
9.23.13.4.	Location and Attachment of Rafters
(1)	[F20-OP2.1, OP2.3, OP2.5] [F22-OP2.3, OP2.5] [F20, F22-OH1.1, OH1.2, OH1.3] [F20, F22-OS1.2] Applies to assemblies required to provide fire resistance. [F20-OS2.1, OS2.3, OS2.5] [F22-OS2.3, OS2.5]
(2)	[F20-OP2.1, OP2.3, OP2.5] [F22-OP2.3, OP2.5] [F20, F22-OH1.1, OH1.2, OH1.3] [F20, F22-OS1.2] Applies to assemblies required to provide fire resistance. [F20-OS2.1, OS2.3, OS2.5] [F22-OS2.3, OS2.5]
(3)	[F20-OP2.1, OP2.3, OP2.5] [F22-OP2.3, OP2.5] [F20, F22-OH1.1, OH1.2, OH1.3] [F20, F22-OS1.2] Applies to assemblies required to provide fire resistance. [F20-OS2.1, OS2.3, OS2.5] [F22-OS2.3, OS2.5]
9.23.13.5.	Shaping of Rafters
(1)	[F20-OP2.1, OP2.3, OP2.5] [F22-OP2.3, OP2.5] [F20, F22-OH1.1, OH1.2, OH1.3] [F20, F22-OS1.2] Applies to assemblies required to provide fire resistance. [F20-OS2.1, OS2.3, OS2.5] [F22-OS2.3, OS2.5]
9.23.13.6.	Hip and Valley Rafters
(1)	[F20-OP2.1, OP2.3, OP2.5] [F22-OP2.3, OP2.5] [F20-OS2.1, OS2.3, OS2.5] [F22-OS2.3, OS2.5] [F20, F22-OH1.1, OH1.2, OH1.3]
9.23.13.7.	Intermediate Support for Rafters and Joists
(1)	[F20-OP2.1, OP2.3, OP2.5] [F22-OP2.3, OP2.5] [F20, F22-OH1.1, OH1.2, OH1.3] [F20, F22-OS1.2] Applies to assemblies required to provide fire resistance. [F20-OS2.1, OS2.3, OS2.5] [F22-OS2.3, OS2.5]
(2)	[F20-OP2.1, OP2.3, OP2.5] [F22-OP2.3, OP2.5] [F20-OS2.1, OS2.3, OS2.5] [F22-OS2.3, OS2.5]
(3)	
(4)	[F20-OP2.1, OP2.3, OP2.5] [F22-OP2.3, OP2.5] [F20, F22-OH1.1, OH1.2, OH1.3] [F20, F22-OS1.2] Applies to assemblies required to provide fire resistance. [F20-OS2.1, OS2.3, OS2.5] [F22-OS2.3, OS2.5]
(5)	[F20-OP2.1, OP2.3, OP2.5] [F22-OP2.3, OP2.5] [F20, F22-OH1.1, OH1.2, OH1.3] [F20, F22-OS1.2] Applies to assemblies required to provide fire resistance. [F20-OS2.1, OS2.3, OS2.5] [F22-OS2.3, OS2.5]
(6)	[F20-OP2.1, OP2.3, OP2.5] [F22-OP2.3, OP2.4, OP2.5] [F20, F22-OH1.1, OH1.2, OH1.3] [F22-OH4] [F20, F22-OS1.2] Applies to assemblies required to provide fire resistance.

Acceptable Solution	Objectives and Functional Statements
(6) (Cont'd)	[F22-OS3.1] Applies to floors and elements that support floors. [F22-OS3.7] Applies to walls, and elements that support walls, that contain doors or windows required for emergency egress. [F20-OS2.1, OS2.3, OS2.5] [F22-OS2.3, OS2.5]
9.23.13.8.	Ridge Support
(1)	[F20-OP2.1, OP2.3, OP2.5] [F22-OP2.3, OP2.4, OP2.5] [F20, F22-OH1.1, OH1.2, OH1.3] [F20, F22-OS1.2] Applies to assemblies required to provide fire resistance. [F20-OS2.1, OS2.3, OS2.5] [F22-OS2.3, OS2.5] [F22-OS3.7] Applies to walls, and elements that support walls, that contain doors or windows required for emergency egress.
(2)	
(3)	[F20-OP2.1, OP2.3, OP2.5] [F22-OP2.3, OP2.4, OP2.5] [F20, F22-OH1.1, OH1.2, OH1.3] [F20, F22-OS1.2] Applies to assemblies required to provide fire resistance. [F20-OS2.1, OS2.3, OS2.5] [F22-OS2.3, OS2.5] [F22-OS3.7] Applies to walls, and elements that support walls, that contain doors or windows required for emergency egress.
(4)	[F20-OP2.1, OP2.3, OP2.5] [F22-OP2.3, OP2.4, OP2.5] [F20, F22-OH1.1, OH1.2, OH1.3] [F20, F22-OS1.2] Applies to assemblies required to provide fire resistance. [F20-OS2.1, OS2.3, OS2.5] [F22-OS2.3, OS2.5] [F22-OS3.7] Applies to walls, and elements that support walls, that contain doors or windows required for emergency egress.
(5)	[F20-OP2.1, OP2.3, OP2.5] [F22-OP2.3, OP2.4, OP2.5] [F20, F22-OH1.1, OH1.2, OH1.3] [F20, F22-OS1.2] Applies to assemblies required to provide fire resistance. [F20-OS2.1, OS2.3, OS2.5] [F22-OS2.3, OS2.5] [F22-OS3.7] Applies to walls, and elements that support walls, that contain doors or windows required for emergency egress.
(6)	[F20-OP2.1, OP2.3, OP2.5] [F22-OP2.3, OP2.4, OP2.5] [F20, F22-OH1.1, OH1.2, OH1.3] [F20, F22-OS1.2] Applies to assemblies required to provide fire resistance. [F20-OS2.1, OS2.3, OS2.5] [F22-OS2.3, OS2.5] [F22-OS3.7] Applies to walls, and elements that support walls, that contain doors or windows required for emergency egress.
(7)	[F20-OP2.1, OP2.3, OP2.5] [F22-OP2.3, OP2.4, OP2.5] [F20, F22-OH1.1, OH1.2, OH1.3] [F20, F22-OS1.2] Applies to assemblies required to provide fire resistance. [F20-OS2.1, OS2.3, OS2.5] [F22-OS2.3, OS2.5] [F22-OS3.7] Applies to walls, and elements that support walls, that contain doors or windows required for emergency egress.
9.23.13.9.	Restraint of Joist Bottoms
(1)	[F20-OP2.1, OP2.3, OP2.5] [F22-OP2.3, OP2.5] [F20, F22-OH1.1, OH1.2, OH1.3] [F20, F22-OS1.2] Applies to assemblies required to provide fire resistance. [F20-OS2.1, OS2.3, OS2.5] [F22-OS2.3, OS2.5]
9.23.13.10.	Ceiling Joists Supporting Roof Load
(1)	[F20-OP2.1, OP2.3, OP2.5] [F22-OP2.3, OP2.5] [F20, F22-OH1.1, OH1.2, OH1.3] [F20, F22-OS1.2] Applies to assemblies required to provide fire resistance. [F20-OS2.1, OS2.3, OS2.5] [F22-OS2.3, OS2.5]

Acceptable Solution	Objectives and Functional Statements
(2)	[F20-OP2.1, OP2.3, OP2.5] [F22-OP2.3, OP2.5] [F20, F22-OH1.1, OH1.2, OH1.3] [F20, F22-OS1.2] Applies to assemblies required to provide fire resistance. [F20-OS2.1, OS2.3, OS2.5] [F22-OS2.3, OS2.5]
9.23.13.11.	Wood Roof Trusses
(1)	[F20-OP2.1, OP2.3, OP2.5] [F22-OP2.3, OP2.4, OP2.5] [F20-OS2.1, OS2.3, OS2.5] [F22-OS2.3, OS2.5] (b) [F20, F22-OS1.2] Applies to assemblies required to provide fire resistance. (b) [F20, F22-OH1.1, OH1.2, OH1.3]
(2)	
(3)	[F20-OP2.1, OP2.3, OP2.5] [F22-OP2.3, OP2.4, OP2.5] [F20-OS2.1, OS2.3, OS2.5] [F22-OS2.3, OS2.4, OS2.5]
(4)	[F20-OP2.1, OP2.3, OP2.5] [F22-OP2.3, OP2.4, OP2.5] [F20-OS2.1, OS2.3, OS2.5] [F22-OS2.3, OS2.4, OS2.5]
(5)	[F20-OP2.1, OP2.3, OP2.5] [F22-OP2.3, OP2.4, OP2.5] [F20, F22-OH1.1, OH1.2, OH1.3] [F20, F22-OS1.2] Applies to assemblies required to provide fire resistance. [F20-OS2.1, OS2.3, OS2.5] [F22-OS2.3, OS2.4, OS2.5]
(6)	[F20-OP2.1, OP2.3, OP2.5] [F22-OP2.3, OP2.4, OP2.5] [F20, F22-OH1.1, OH1.2, OH1.3] [F20, F22-OS1.2] Applies to assemblies required to provide fire resistance. [F20-OS2.1, OS2.3, OS2.5] [F22-OS2.3, OS2.4, OS2.5]
9.23.14.1.	Subflooring Required
(1)	[F20-OS2.1]
9.23.14.2.	Material Standards
(1)	[F22-OH4] [F22-OP2.4] [F20-OS2.1] [F22-OS3.1]
(2)	[F80-OH4] [F80-OP2.4] [F80-OS2.1] [F80-OS3.1]
(3)	[F22-OH4] [F22-OP2.4] [F20-OS2.1] [F22-OS3.1]
(4)	[F80-OH4] [F80-OP2.4] [F80-OS2.1] [F80-OS3.1]
9.23.14.3.	Edge Support
(1)	[F22-OH4] [F22-OP2.4] [F22-OS3.1]
9.23.14.4.	Direction of Installation
(1)	[F22-OH4] [F22-OP2.4] [F22-OS3.1]
(2)	[F22-OH4] [F22-OP2.4] [F22-OS3.1]

Acceptable Solution	Objectives and Functional Statements
9.23.14.5.	Subfloor Thickness or Rating
(1)	[F22-OH4] [F22-OP2.4] [F20-OS2.1] [F22-OS3.1]
(2)	[F22-OH4] [F22-OP2.4] [F20-OS2.1] [F22-OS3.1]
(3)	[F22-OH4] [F22-OP2.4] [F20-OS2.1] [F22-OS3.1]
9.23.14.6.	Annular Grooved Nails
(1)	[F81-OH1.1] [F81-OP2.3] [F81-OS2.3]
9.23.14.7.	Lumber Subflooring
(1)	[F22-OH4] [F22-OP2.4] [F22-OS3.1]
(2)	[F22-OH4] [F22-OP2.4] [F22-OS3.1]
(3)	[F22-OP2.4] [F22-OS3.1]
9.23.15.1.	Required Roof Sheathing
(1)	[F20-OP2.1, OP2.3, OP2.5] [F22-OP2.3, OP2.4, OP2.5] [F20-OS2.1, OS2.3, OS2.5] [F22-OS2.3, OS2.4, OS2.5] [F20, F22-OH1.1, OH1.2, OH1.3]
9.23.15.2.	Material Standards
(1)	[F20-OP2.1, OP2.3, OP2.5] [F22-OP2.3, OP2.4, OP2.5] [F20, F22-OH1.1, OH1.2, OH1.3] [F20, F22-OS1.2] Applies to assemblies required to provide fire resistance. [F20-OS2.1, OS2.3, OS2.5] [F22-OS2.3, OS2.4, OS2.5]
9.23.15.3.	Direction of Installation
(1)	[F20-OP2.1, OP2.3, OP2.5] [F22-OP2.3, OP2.4, OP2.5] [F20, F22-OH1.1, OH1.2, OH1.3] [F20, F22-OS1.2] Applies to assemblies required to provide fire resistance. [F20-OS2.1, OS2.3, OS2.5] [F22-OS2.3, OS2.4, OS2.5]
(2)	[F20-OP2.1, OP2.3, OP2.5] [F22-OP2.3, OP2.4, OP2.5] [F20, F22-OH1.1, OH1.2, OH1.3] [F20, F22-OS1.2] Applies to assemblies required to provide fire resistance. [F20-OS2.1, OS2.3, OS2.5] [F22-OS2.3, OS2.4, OS2.5]
9.23.15.4.	Joints in Panel-Type Sheathing
(1)	[F20-OP2.1, OP2.3, OP2.5] [F22-OP2.3, OP2.4, OP2.5] [F20, F22-OH1.1, OH1.2, OH1.3] [F20, F22-OS1.2] Applies to assemblies required to provide fire resistance. [F20-OS2.1, OS2.3, OS2.5] [F22-OS2.3, OS2.4, OS2.5]
(2)	[F20-OP2.1, OP2.3, OP2.5] [F22-OP2.3, OP2.4, OP2.5] [F20, F22-OH1.1, OH1.2, OH1.3] [F20, F22-OS1.2] Applies to assemblies required to provide fire resistance.

Acceptable Solution	Objectives and Functional Statements
(2) (Cont'd)	[F20-OS2.1, OS2.3, OS2.5] [F22-OS2.3, OS2.4, OS2.5]
9.23.15.5.	Lumber Roof Sheathing
(1)	[F20-OP2.1, OP2.3, OP2.5] [F22-OP2.3, OP2.4, OP2.5] [F20, F22-OH1.1, OH1.2, OH1.3] [F20, F22-OS1.2] Applies to assemblies required to provide fire resistance. [F20-OS2.1, OS2.3, OS2.5] [F22-OS2.3, OS2.4, OS2.5]
9.23.15.6.	Edge Support
(1)	[F20-OP2.1, OP2.3, OP2.5] [F22-OP2.3, OP2.4, OP2.5] [F20, F22-OH1.1, OH1.2, OH1.3] [F20, F22-OS1.2] Applies to assemblies required to provide fire resistance. [F20-OS2.1, OS2.3, OS2.5] [F22-OS2.3, OS2.4, OS2.5]
(2)	
9.23.15.7.	Thickness or Rating
(1)	[F20-OP2.1, OP2.3, OP2.5] [F22-OP2.3, OP2.4, OP2.5] [F20, F22-OH1.1, OH1.2, OH1.3] [F22-OH4] [F20-OS2.1, OS2.3, OS2.5] [F22-OS2.3, OS2.5] [F22-OS3.1]
(2)	[F20-OP2.1, OP2.3, OP2.5] [F22-OP2.3, OP2.4, OP2.5] [F20, F22-OH1.1, OH1.2, OH1.3] [F20-OS2.1, OS2.3, OS2.5] [F22-OS2.3, OS2.5] [F20, F22-OS1.2] Applies to assemblies required to provide fire resistance.
(3)	[F20-OP2.1, OP2.3, OP2.5] [F22-OP2.3, OP2.4, OP2.5] [F20-OS2.1, OS2.3, OS2.5] [F22-OS2.3, OS2.5] [F20, F22-OH1.1, OH1.2, OH1.3]
(4)	[F20-OP2.1, OP2.3, OP2.5] [F22-OP2.3, OP2.4, OP2.5] [F20-OS2.1, OS2.3, OS2.5] [F22-OS2.3, OS2.5] [F20, F22-OH1.1, OH1.2, OH1.3]
9.23.16.1.	Required Sheathing
(1)	[F20-OP2.1, OP2.3, OP2.5] [F22-OP2.3, OP2.4, OP2.5] [F20, F22-OH1.1, OH1.2, OH1.3] [F20, F22-OH4] Applies to floors and elements that support floors. [F20-OS2.1, OS2.3, OS2.5] [F22-OS2.3, OS2.5] [F22-OS3.1] Applies to floors and elements that support floors. [F22-OS3.7] Applies to walls, and elements that support walls, that contain doors or windows required for emergency egress.
9.23.16.2.	Thickness, Rating and Material Standards
(1)	[F20-OP2.1, OP2.3, OP2.5] [F22-OP2.3, OP2.4, OP2.5] [F20, F22-OH1.1, OH1.2, OH1.3] [F20, F22-OH4] Applies to floors and elements that support floors. [F20, F22-OS1.2] Applies to assemblies required to provide fire resistance. [F20-OS2.1, OS2.3, OS2.5] [F22-OS2.3, OS2.5] [F20, F22-OS3.1] Applies to floors and elements that support floors.
9.23.16.3.	Attachment of Cladding to Sheathing
(1)	
(2)	[F20, F22, F80-OH1.1, OH1.2, OH1.3] [F20, F22, F80-OP2.3] Applies to elements that support or are part of an environmental separator. [F20, F22, F80-OS1.2] Applies to assemblies required to provide fire resistance. [F20, F22, F80-OS2.1] Applies to elements that support or are part of an environmental separator. [F22, F80-OS3.7] Applies to walls, and elements that support walls, that contain doors or windows required for emergency egress.

Acceptable Solution	Objectives and Functional Statements
9.23.16.4.	Lumber Sheathing
(1)	[F20-OP2.1, OP2.3, OP2.5] [F22-OP2.3, OP2.4, OP2.5] [F20, F22-OH1.1, OH1.2, OH1.3] [F20, F22-OH4] Applies to floors and elements that support floors. [F20, F22-OS1.2] Applies to assemblies required to provide fire resistance. [F20-OS2.1, OS2.3, OS2.5] [F22-OS2.3, OS2.5] [F20, F22-OS3.1] Applies to floors and elements that support floors.
(2)	[F20-OP2.1, OP2.3, OP2.5] [F22-OP2.3, OP2.4, OP2.5] [F20, F22-OH1.1, OH1.2, OH1.3] [F20, F22-OH4] Applies to floors and elements that support floors. [F20, F22-OS1.2] Applies to assemblies required to provide fire resistance. [F20-OS2.1, OS2.3, OS2.5] [F22-OS2.3, OS2.5] [F22-OS3.1] Applies to floors and elements that support walls. [F22-OS3.7] Applies to walls, and elements that support walls, that contain doors or windows required for emergency egress.
9.23.16.5.	Joints in Panel-Type Sheathing
(1)	[F80, F81-OH1.1, OH1.2, OH1.3] [F80, F81-OH4] Applies to floors and elements that support floors. [F80, F81-OP2.3, OP2.4] [F80, F81-OS2.3] [F80, F81-OS3.1] Applies to floors and elements that support floors.
9.23.16.6.	Mansard Style Roofs
(1)	
9.24.1.1.	Application
(1)	
(2)	
9.24.1.2.	Material Standards
(1)	[F20, F22, F80-OH1.1, OH1.2, OH1.3] [F20-OP2.1, OP2.4] [F22, F80-OP2.4] [F20, F22, F80-OP2.3] Applies to elements that support or are part of an environmental separator. [F20-OS2.1, OS2.4] [F22, F80-OS2.4] [F20, F22, F80-OS2.3] Applies to elements that support or are part of an environmental separator. [F20, F22, F80-OS1.2] Applies to assemblies required to provide fire resistance. [F22, F80-OS3.7] Applies to walls, and elements that support walls, that contain doors or windows required for emergency egress.
9.24.1.3.	Metal Thickness
(1)	
9.24.1.4.	Screws
(1)	[F20, F22, F80-OH1.1, OH1.2, OH1.3] [F20-OP2.1, OP2.4] [F22, F80-OP2.4] [F20, F22, F80-OP2.3] Applies to elements that support or are part of an environmental separator. [F20, F22, F80-OS1.2] Applies to assemblies required to provide fire resistance. [F20-OS2.1, OS2.4] [F22, F80-OS2.4] [F20, F22, F80-OS2.3] Applies to elements that support or are part of an environmental separator. [F22, F80-OS3.7] Applies to walls, and elements that support walls, that contain doors or windows required for emergency egress.
9.24.1.5.	Cladding, Sheathing and Interior Finish Required
(1)	[F20, F22, F80-OH1.1, OH1.2, OH1.3] [F20, F22, F80-OP2.3] Applies to elements that support or are part of an environmental separator.

Acceptable Solution	Objectives and Functional Statements
(1) (Cont'd)	[F20, F22, F80-OS1.2] Applies to assemblies required to provide fire resistance. [F20, F22, F80-OS2.1] Applies to elements that support or are part of an environmental separator. [F22, F80-OS3.7] Applies to walls, and elements that support walls, that contain doors or windows required for emergency egress.
9.24.2.1.	Size and Spacing of Studs in Interior Walls
(1)	[F20-OP2.1, OP2.4] [F22-OP2.4] [F20-OS2.1, OS2.4] [F22-OS2.4] [F22-OS3.7] Applies to walls, and elements that support walls, that contain doors or windows required for emergency egress.
9.24.2.2.	Thickness of Studs
(1)	[F20-OP2.1, OP2.4] [F22-OP2.4] [F20-OS2.1, OS2.4] [F22-OS2.4] [F22-OS3.7] Applies to walls, and elements that support walls, that contain doors or windows required for emergency egress.
9.24.2.3.	Runners
(1)	[F20, F22-OH1.1, OH1.2, OH1.3] [F20-OP2.1, OP2.4] [F22-OP2.4] [F20, F22-OP2.3] Applies to elements that support or are a part of an environmental separator. [F20-OS2.1, OS2.4] [F22-OS2.4] [F20, F22-OS2.3] Applies to elements that support or are a part of an environmental separator. [F20, F22-OS1.2] Applies to assemblies required to provide fire resistance.
9.24.2.4.	Openings in Fire Separations
(1)	[F20-OS1.2]
(2)	[F20-OS1.2]
(3)	[F20-OS1.2]
(4)	[F20-OS1.2]
9.24.2.5.	Size and Spacing of Studs in Exterior Walls
(1)	[F20-OP2.1, OP2.3, OP2.4] [F22-OP2.3, OP2.4] [F20, F22-OH1.1, OH1.2, OH1.3] [F20, F22-OS1.2] Applies to assemblies required to provide fire resistance. [F20-OS2.1, OS2.3, OS2.4] [F22-OS2.3, OS2.4] [F22, F80-OS3.7] Applies to walls, and elements that support walls, that contain doors or windows required for emergency egress.
9.24.3.1.	Installation of Runners
(1)	[F20, F22-OH1.1, OH1.2, OH1.3] [F20-OP2.1, OP2.4] [F22-OP2.4] [F20, F22-OP2.3] Applies to elements that support or are part of an environmental separator. [F20, F22-OS1.2] Applies to assemblies required to provide fire resistance. [F20-OS2.1, OS2.4] [F22-OS2.4] [F20, F22-OS2.3] Applies to elements that support or are part of an environmental separator. [F22, F80-OS3.7] Applies to walls, and elements that support walls, that contain doors or windows required for emergency egress.
(2)	[F20, F22-OH1.1, OH1.2, OH1.3] [F20-OP2.1, OP2.4] [F22-OP2.4] [F20, F22-OP2.3] Applies to elements that support or are part of an environmental separator. [F20-OS2.1, OS2.4] [F22-OS2.4] [F20, F22-OS2.3] Applies to elements that support or are part of an environmental separator. [F20, F22-OS1.2] Applies to assemblies required to provide fire resistance.

Acceptable Solution	Objectives and Functional Statements
(2) (Cont'd)	[F22, F80-OS3.7] Applies to walls, and elements that support walls, that contain doors or windows required for emergency egress.
(3)	[F20, F22-OH1.1, OH1.2, OH1.3] [F20-OP2.1, OP2.4] [F20, F22-OP2.3] Applies to elements that support or are part of an environmental separator. [F20, F22-OS1.2] Applies to assemblies required to provide fire resistance. [F20-OS2.1, OS2.4] [F22-OS2.4] [F20, F22-OS2.3] Applies to elements that support or are part of an environmental separator. [F22, F80-OS3.7] Applies to walls, and elements that support walls, that contain doors or windows required for emergency egress.
(4)	[F20, F22-OH1.1, OH1.2, OH1.3] [F20-OP2.1, OP2.4] [F22-OP2.4] [F20, F22-OP2.3] Applies to elements that support or are part of an environmental separator. [F20, F22-OS1.2] Applies to assemblies required to provide fire resistance. [F20-OS2.1, OS2.4] [F22-OS2.4] [F20, F22-OS2.3] Applies to elements that support or are part of an environmental separator. [F22, F80-OS3.7] Applies to walls, and elements that support walls, that contain doors or windows required for emergency egress.
9.24.3.2.	Fire-Rated Walls
(1)	[F21-OS1.2]
(2)	[F21-OS1.2]
(3)	[F20-OS1.2]
(4)	[F20-OS1.2]
9.24.3.3.	Orientation of Studs
(1)	[F20, F22-OH1.1, OH1.2, OH1.3] [F20-OP2.1, OP2.4] [F22-OP2.4] [F20, F22-OP2.3] Applies to elements that support or are part of an environmental separator. [F20, F22-OS1.2] Applies to assemblies required to provide fire resistance. [F20-OS2.1, OS2.4] [F22-OS2.4] [F20, F22-OS2.3] Applies to elements that support or are part of an environmental separator. [F22, F80-OS3.7] Applies to walls, and elements that support walls, that contain doors or windows required for emergency egress.
9.24.3.4.	Support for Cladding Materials
(1)	[F20-OH1.1, OH1.2, OH1.3] [F20-OP2.1, OP2.4] [F20-OP2.3] Applies to elements that support or are part of an environmental separator. [F20-OS1.2] Applies to assemblies required to provide fire resistance. [F20-OS2.1, OS2.4] [F20-OS2.3] Applies to elements that support or are part of an environmental separator. [F22-OS3.7] Applies to walls, and elements that support walls, that contain doors or windows required for emergency egress.
9.24.3.5.	Framing around Openings
(1)	[F20, F22-OH1.1, OH1.2, OH1.3] [F20-OP2.1, OP2.4] [F22-OP2.4] [F20, F22-OP2.3] Applies to elements that support or are part of an environmental separator. [F20, F22-OS1.2] Applies to assemblies required to provide fire resistance. [F20-OS2.1, OS2.4] [F22-OS2.4] [F20, F22-OS2.3] Applies to elements that support or are part of an environmental separator.

Acceptable Solution	Objectives and Functional Statements
(1) (Cont'd)	[F22, F80-OS3.7] Applies to walls, and elements that support walls, that contain doors or windows required for emergency egress.
(2)	[F20, F22-OH1.1, OH1.2, OH1.3]
	[F20-OP2.1, OP2.4]
	[F22-OP2.4]
	[F20, F22-OP2.3] Applies to elements that support or are part of an environmental separator.
	[F20-OS2.1, OS2.4]
	[F22-OS2.4]
	[F20, F22-OS2.3] Applies to elements that support or are part of an environmental separator.
	[F20, F22-OS1.2] Applies to assemblies required to provide fire resistance.
	[F22, F80-OS3.7] Applies to walls, and elements that support walls, that contain doors or windows required for emergency egress.
9.24.3.6.	Attachment of Studs to Runners
(1)	[F20, F22-OH1.1, OH1.2, OH1.3]
	[F20-OP2.1, OP2.4]
	[F22-OP2.4]
	[F20, F22-OP2.3] Applies to elements that support or are part of an environmental separator.
	[F20-OS2.1, OS2.4]
	[F22-OS2.4]
	[F20, F22-OS2.3] Applies to elements that support or are part of an environmental separator.
	[F20, F22-OS1.2] Applies to assemblies required to provide fire resistance.
	[F22, F80-OS3.7] Applies to walls, and elements that support walls, that contain doors or windows required for emergency egress.
(2)	[F21-OS1.2]
9.24.3.7.	Openings for Fire Dampers
(1)	[F20-OS1.2]
(2)	[F20-OS1.2]
(3)	[F03-OS1.2]
9.25.1.1.	Scope and Application
(1)	
(2)	[F51, F63-OH1.1, OH1.2] [F63-OS2.3]
(3)	
9.25.2.1.	Required Insulation
(1)	[F51, F63-OH1.1, OH1.2]
	[F63-OS2.3]
9.25.2.2.	Insulation Materials
(1)	[F51, F63, F80-OH1.1, OH1.2]
	[F63, F80-OS2.3]
(2)	
(3)	[F51, F63-OH1.1, OH1.2]
	[F63-OS2.3]
(4)	[F51, F63, F80-OH1.1, OH1.2]
	[F63, F80-OS2.3]
9.25.2.3.	Installation of Thermal Insulation
(1)	[F51, F63-OH1.1, OH1.2]
	[F63-OS2.3]
(2)	[F51, F63-OH1.1, OH1.2]
	[F63-OS2.3]
(3)	[F55-OH1.1, OH1.2]
	[F55-OS2.3]
(4)	[F51, F63, F80-OH1.1, OH1.2]
	[F63, F80-OS2.3]
(5)	[F21-OH1.1, OH1.2, OH1.3]
	[F21-OS2.2, OS2.3]
(6)	[F80-OH1.1, OH1.2]
	[F80-OS2.3]

Acceptable Solution	Objectives and Functional Statements
(7)	[F80-OH1.1, OH1.2] [F80-OS2.3]
(8)	
(9)	[F21-OH1.1, OH1.2] [F21-OS2.3]
9.25.2.4.	Installation of Loose-Fill Insulation
(1)	[F51, F63-OH1.1, OH1.2] [F63-OS2.3]
(2)	[F51-OH1.1, OH1.2, OH1.3] [F51-OS2.3]
(3)	
(4)	(a) [F21, F51-OH1.1, OH1.2] (a) [F21, F51-OS2.3] (c) [F81-OH1.1, OH1.2] (c) [F81-OH1.1, OH1.2, OH1.3] Applies where the interior finish provide the required bracing. (c) [F81-OH4] Applies where the interior finish provides the required bracing of walls that support floors. (c) [F81-OP2.1, OP2.3, OP2.4, OP2.5] Applies where the interior finish provides the required bracing. (c) [F81-OP3.1] Applies where the interior finish contributes to the required fire resistance of the wall. (c) [F81-OS2.1, OS2.3] (c) [F81-OS2.1, OS2.3, OS2.4, OS2.5] Applies where the interior finish provides the required bracing. (c) [F81-OS3.7] Applies where the interior finish provides the required bracing. (c) [F81-OS3.1] Applies where the interior finish provides the required bracing of walls that support floors. (d) [F80-OH1.1, OH1.2, OH1.3] (d) [F80-OS2.3]
(5)	[F51, F63-OH1.1, OH1.2] [F63-OS2.3]
(6)	(a) [F51, F62-OH1.1, OH1.2, OH1.3] (a) [F62, F51-OS2.3] (b) [F51, F63-OH1.1, OH1.2] (b) [F51, F63-OS2.3]
9.25.2.5.	Installation of Spray-Applied Polyurethane
(1)	[F41, F51, F63-OH1.1] [F51, F63-OH1.2] [F63-OS2.3]
9.25.3.1.	Required Barrier to Air Leakage
(1), (2)	[F55-OH1.1, OH1.2, OH1.3] [F44-OS1.1] Applies where the <i>air barrier system</i> separates a garage, or <i>suite</i> containing a garage, from residential space. [F55-OS2.3] [F44-OS3.4] Applies where the <i>air barrier system</i> separates a garage, or <i>suite</i> containing a garage, from residential space.
9.25.3.2.	Air Barrier System Properties
(1)	[F20, F55-OH1.1, OH1.2, OH1.3] [F20, F44-OS1.1] Applies where the <i>air barrier system</i> separates a garage, or <i>suite</i> containing a garage, from residential space. [F55-OS2.3] [F20, F44-OS3.4] Applies where the <i>air barrier system</i> separates a garage, or <i>suite</i> containing a garage, from residential space.
(2)	[F20, F55-OH1.1, OH1.2, OH1.3] [F20, F44-OS1.1] Applies where the <i>air barrier system</i> separates a garage, or <i>suite</i> containing a garage, from residential space. [F55-OS2.3] [F20, F44-OS3.4] Applies where the <i>air barrier system</i> separates a garage, or <i>suite</i> containing a garage, from residential space.

R11.1

Acceptable Solution	Objectives and Functional Statements
9.25.3.3.	Continuity of the Air Barrier System
(1)	[F55-OH1.1, OH1.2, OH1.3] [F44-OS1.1] Applies where the <i>air barrier system</i> separates a garage, or <i>suite</i> containing a garage, from residential space. [F55-OS2.3] [F44-OS3.4] Applies where the <i>air barrier system</i> separates a garage, or <i>suite</i> containing a garage, from residential space.
(2)	[F55-OH1.1, OH1.2, OH1.3] [F40-OH1.1] [F55-OS2.3] (a) [F44-OS1.1] Applies where the <i>air barrier system</i> separates a garage, or <i>suite</i> containing a garage, from residential space. (a) [F44-OS3.4] Applies where the <i>air barrier system</i> separates a garage, or <i>suite</i> containing a garage, from residential space.
(3)	[F55-OH1.1, OH1.2, OH1.3] [F40-OH1.1] [F55-OS2.3] (a) [F44-OS1.1] Applies where the <i>air barrier system</i> separates a garage, or <i>suite</i> containing a garage, from residential space. (a) [F44-OS3.4] Applies where the <i>air barrier system</i> separates a garage, or <i>suite</i> containing a garage, from residential space.
(4)	
(5)	
(6)	[F55-OH1.1, OH1.2, OH1.3][F40-OH1.1] [F44-OS1.1] Applies where the <i>air barrier system</i> separates a garage, or <i>suite</i> containing a garage, from residential space. [F55-OS2.3] [F44-OS3.4] Applies where the <i>air barrier system</i> separates a garage, or <i>suite</i> containing a garage, from residential space.
(7)	[F55-OH1.1, OH1.2, OH1.3] [F40-OH1.1] [F44-OS1.1] Applies where the <i>air barrier system</i> separates a garage, or <i>suite</i> containing a garage, from residential space. [F55-OS2.3] [F44-OS3.4] Applies where the <i>air barrier system</i> separates a garage, or <i>suite</i> containing a garage, from residential space.
(8)	[F55-OH1.1, OH1.2, OH1.3] [F40-OH1.1] [F44-OS1.1] Applies where the <i>air barrier system</i> separates a garage, or <i>suite</i> containing a garage, from residential space. [F55-OS2.3] [F44-OS3.4] Applies where the <i>air barrier system</i> separates a garage, or <i>suite</i> containing a garage, from residential space.
(9)	[F55-OH1.1, OH1.2, OH1.3] [F40-OH1.1] [F44-OS1.1] Applies where the <i>air barrier system</i> separates a garage, or <i>suite</i> containing a garage, from residential space. [F55-OS2.3] [F44-OS3.4] Applies where the <i>air barrier system</i> separates a garage, or <i>suite</i> containing a garage, from residential space.
(10)	[F55-OH1.1, OH1.2, OH1.3] [F40-OH1.1] [F44-OS1.1] Applies where the <i>air barrier system</i> separates a garage, or <i>suite</i> containing a garage, from residential space. [F55-OS2.3] [F44-OS3.4] Applies where the <i>air barrier system</i> separates a garage, or <i>suite</i> containing a garage, from residential space.

Acceptable Solution	Objectives and Functional Statements
(11)	[F55-OH1.1, OH1.2, OH1.3] [F40-OH1.1] [F44-OS1.1] Applies where the <i>air barrier system</i> separates a garage, or <i>suite</i> containing a garage, from residential space. [F55-OS2.3] [F44-OS3.4] Applies where the <i>air barrier system</i> separates a garage, or <i>suite</i> containing a garage, from residential space.
(12)	[F55-OH1.1, OH1.2, OH1.3] [F40-OH1.1] [F44-OS1.1] Applies where the <i>air barrier system</i> separates a garage, or <i>suite</i> containing a garage, from residential space. [F55-OS2.3] [F44-OS3.4] Applies where the <i>air barrier system</i> separates a garage, or <i>suite</i> containing a garage, from residential space.
(13)	[F55-OH1.1, OH1.2, OH1.3] [F55-OS2.3]
(14)	[F01-OS1.1]
(15)	[F55-OH1.1, OH1.2, OH1.3]
(16)	[F55-OH1.1, OH1.2, OH1.3] [F40-OH1.1] [F55-OS2.3]
9.25.3.4.	Vapour Barriers Used as Air Barriers
(1)	
9.25.4.1.	Required Barrier to Vapour Diffusion
(1)	[F63-OH1.1, OH1.2] [F63-OS2.3]
9.25.4.2.	Vapour Barrier Materials
(1)	[F63-OH1.1, OH1.2] [F63-OS2.3]
(2)	[F62, F63-OH1.1, OH1.2] [F62, F63-OS2.3]
(3)	[F63, F80-OH1.1, OH1.2] [F63, F80-OS2.3]
(4)	[F63, F80-OH1.1, OH1.2] [F63, F80-OS2.3]
(5)	[F63, OH1.1, OH1.2] [F63, OS2.3]
(6)	[F63-OH1.1, OH1.2] [F63-OS2.3]
9.25.4.3.	Installation of Vapour Barriers
(1)	[F63-OH1.1, OH1.2] [F63-OS2.3]
(2)	[F63-OH1.1, OH1.2] [F63-OS2.3]
(3)	[F63-OS2.3]
9.25.5.1.	General
(1)	
(2)	[F62, F63-OS2.3] [F62, F63-OH1.1, OH1.2]
(3)	
(4)	
9.25.5.2.	Position of Low Permeance Materials
(1)	[F62, F63-OS2.3] [F62, F63-OH1.1, OH1.2]
(2)	

F11.1

	Acceptable Solution	Objectives and Functional Statements
R11.1	9.26.1.1.	Purpose of Roofing
	(1)	
R11.1	9.26.1.1A.	Required Protection
	(1)	[F61-OH1.1, OH1.2, OH1.3] [F61-OS2.3]
	(2)	
R11.1	9.26.1.2.	Alternate Installation Methods
	(1)	[F61-OH1.1, OH1.2, OH1.3] [F61-OS2.3]
R11.1	9.26.1.3.	Solar Collector Systems
	(1)	
R11.1	9.26.2.1.	Material Standards
	(1), (2)	[F61-OH1.1, OH1.2, OH1.3] [F61-OS2.3]
R11.1	9.26.2.2.	Installation of Materials
	(1)	[F61-OH1.1, OH1.2, OH1.3] [F61-OS2.3]
R11.1	9.26.2.3.	Nails
	(1)	[F20, F80-OH1.1, OH1.2, OH1.3] [F20, F80-OS2.3]
	(2), (3)	[F20-OH1.1, OH1.2, OH1.3] [F20-OS2.3]
	(4)	[F20, F80-OH1.1, OH1.2, OH1.3] [F20, F80-OS2.3]
R11.1	9.26.2.4.	Staples
	(1)	[F20, F80-OH1.1, OH1.2, OH1.3] [F20, F80-OS2.3]
	(2)	[F20-OH1.1, OH1.2, OH1.3] [F20-OS2.3]
	(3)	[F20, F80-OH1.1, OH1.2, OH1.3] [F20, F80-OS2.3]
E6.1	9.26.3.1.	Slope
	(1)	[F20, F61, F80-OH1.1, OH1.2, OH1.3] [F20-OS2.1, OS2.3] [F61, F80-OS2.3]
	(2)	[F20, F61, F80-OH1.1, OH1.2, OH1.3] [F20, F61, F80-OS2.3]
	(3), (4)	[F61, F80-OH1.1, OH1.2, OH1.3] [F61, F80-OS2.3]
	(5)	[F21-OH1.1, OH1.2, OH1.3] [F21-OS2.3]
R11.1	9.26.4.1.	Required Flashing at Intersections
	(1)	[F61-OH1.1, OH1.2, OH1.3] [F61-OS2.3]
	9.26.4.2.	Materials
	(1)	[F61, F62, F80-OH1.1, OH1.2, OH1.3] [F61, F62, F80-OS2.3]
	9.26.4.3.	Valley Flashing
(1)	[F61-OH1.1, OH1.2, OH1.3] [F61-OS2.3]	
(2)	[F20, F22-OH1.1, OH1.2, OH1.3] [F20-OS2.1, OS2.3] [F22-OS2.3, OS2.4]	

Acceptable Solution	Objectives and Functional Statements
(3)	[F61-OH1.1, OH1.2, OH1.3] [F61-OS2.3]
(4)	[F20, F61, F80-OH1.1, OH1.2, OH1.3] [F20, F61, F80-OS2.3]
(5)	[F20, F61, F80-OH1.1, OH1.2, OH1.3] [F20, F61, F80-OS2.3]
(6)	[F20, F61, F80-OH1.1, OH1.2, OH1.3] [F20, F61, F80-OS2.3]
(7)	[F20, F61, F80-OH1.1, OH1.2, OH1.3] [F20, F61, F80-OS2.3]
9.26.4.4.	Intersection of Shingle Roofs and Masonry
(1)	[F61-OH1.1, OH1.2, OH1.3] [F61-OP1.1] Applies where a shingle roof intersects with a masonry <i>chimney</i> . [F61-OS1.1] Applies where a shingle roof intersects with a masonry <i>chimney</i> . [F61-OS2.3] [F61-OS3.4] Applies where a shingle roof intersects with a masonry <i>chimney</i> .
(2)	[F61-OH1.1, OH1.2, OH1.3] [F61-OP1.1] Applies where counter flashing is installed between a shingle roof and a masonry <i>chimney</i> . [F61-OS1.1] Applies where counter flashing is installed between a shingle roof and a masonry <i>chimney</i> . [F61-OS2.3] [F61-OS3.4] Applies where counter flashing is installed between a shingle roof and a masonry <i>chimney</i> .
(3)	[F61-OH1.1, OH1.2, OH1.3] [F61-OP1.1] Applies where flashing is installed between a shingle roof and a masonry <i>chimney</i> . [F61-OS1.1] Applies where flashing is installed between a shingle roof and a masonry <i>chimney</i> . [F61-OS2.3] [F61-OS3.4] Applies where flashing is installed between a shingle roof and a masonry <i>chimney</i> .
(4)	[F61-OH1.1, OH1.2, OH1.3] [F61-OP1.1] Applies where a shingle roof slopes upward from a masonry <i>chimney</i> . [F61-OS1.1] Applies where a shingle roof slopes upward from a masonry <i>chimney</i> . [F61-OS2.3] [F61-OS3.4] Applies where a shingle roof slopes upward from a masonry <i>chimney</i> .
9.26.4.5.	Intersection of Shingle Roofs and Walls Other Than Masonry
(1)	[F61-OH1.1, OH1.2, OH1.3] [F61-OS2.3]
(2)	[F61-OH1.1, OH1.2, OH1.3] [F61-OS2.3]
(3)	[F61-OH1.1, OH1.2, OH1.3] [F61-OS2.3]
9.26.4.6.	Intersection of Built-Up Roofs and Masonry
(1)	[F61-OH1.1, OH1.2, OH1.3] [F61-OP1.1] Applies where a built-up roof intersects with a masonry <i>chimney</i> . [F61-OS1.1] Applies where a built-up roof intersects with a masonry <i>chimney</i> . [F61-OS2.3] [F61-OS3.4] Applies where a built-up roof intersects with a masonry <i>chimney</i> .
(2)	[F61-OH1.1, OH1.2, OH1.3] [F61-OP1.1] Applies where counter flashing is installed between a built-up roof and a masonry <i>chimney</i> . [F61-OS1.1] Applies where counter flashing is installed between a built-up roof and a masonry <i>chimney</i> . [F61-OS2.3] [F61-OS3.4] Applies where counter flashing is installed between a built-up roof and a masonry <i>chimney</i> .
9.26.4.7.	Intersection of Built-Up Roofs and Walls Other Than Masonry
(1)	[F61-OH1.1, OH1.2, OH1.3] [F61-OS2.3]

Acceptable Solution	Objectives and Functional Statements
(2)	[F61-OH1.1, OH1.2, OH1.3] [F61-OS2.3]
(3)	[F61-OH1.1, OH1.2, OH1.3] [F61-OS2.3]
9.26.4.8.	Chimney Saddles
(1)	[F61-OH1.1, OH1.2, OH1.3] [F61-OP1.1] [F61-OS1.1] [F61-OS2.3] [F61-OS3.4]
(2)	[F20, F80-OH1.1, OH1.2, OH1.3] [F20, F80-OP1.1] [F20, F80-OS1.1] [F20, F80-OS2.3] [F20, F80-OS3.4]
(3)	[F61-OH1.1, OH1.2, OH1.3] [F61-OS2.3]
(4)	
(5)	[F61-OH1.1, OH1.2, OH1.3] [F61-OP1.1] [F61-OS1.1] [F61-OS2.3] [F61-OS3.4]
(6)	
9.26.5.1.	Required Eave Protection
(1)	[F61-OH1.1, OH1.2, OH1.3] [F61-OS2.3]
(2)	
9.26.5.2.	Materials
(1)	[F61-OH1.1, OH1.2, OH1.3] [F61-OS2.3]
9.26.6.1.	Materials
(1)	[F61-OH1.1, OH1.2, OH1.3] [F61-OS2.3]
(2)	[F62-OH1.1, OH1.2, OH1.3] [F62-OS2.3]
9.26.6.2.	Installation
(1)	[F61-OH1.1, OH1.2, OH1.3] [F61-OS2.3]
(2)	[F61-OH1.1, OH1.2, OH1.3] [F61-OS2.3]
(3)	[F61-OH1.1, OH1.2, OH1.3] [F61-OS2.3]
9.26.7.1.	Coverage
(1)	[F61, F80-OH1.1, OH1.2, OH1.3] [F61, F80-OS2.1]
9.26.7.2.	Starter Strip
(1)	[F61-OH1.1, OH1.2, OH1.3] [F61-OS2.3]
(2)	[F61, F80-OH1.1, OH1.2, OH1.3] [F61, F80-OS2.3]

Acceptable Solution	Objectives and Functional Statements
(3)	[F61-OH1.1, OH1.2, OH1.3] [F61-OS2.3]
9.26.7.3.	Head Lap
(1)	[F61-OH1.1, OH1.2, OH1.3] [F61-OS2.3]
9.26.7.4.	Fasteners
(1)	[F20, F61-OH1.1, OH1.2, OH1.3] [F20, F61-OS2.3]
(2)	[F20-OH1.1, OH1.2, OH1.3] [F20-OS2.3]
(3)	[F20-OH1.1, OH1.2, OH1.3] [F20-OS2.3]
(4)	[F20-OH1.1, OH1.2, OH1.3] [F20-OS2.3]
(5)	[F20-OH1.1, OH1.2, OH1.3] [F20-OS2.3]
9.26.7.5.	Securing of Tabs
(1)	[F20, F61-OH1.1, OH1.2, OH1.3] [F20, F61-OS2.3]
9.26.7.6.	Hips and Ridges
(1)	[F61-OH1.1, OH1.2, OH1.3] [F61-OS2.3]
(2)	[F20-OH1.1, OH1.2, OH1.3] [F20-OS2.3]
9.26.7.7.	Eave Protection
(1)	
9.26.7.8.	Flashing
(1)	
9.26.8.1.	Coverage
(1)	[F61-OH1.1, OH1.2, OH1.3] [F61-OS2.3]
9.26.8.2.	Starter Strip
(1)	
(2)	[F61-OH1.1, OH1.2, OH1.3] [F61-OS2.3]
9.26.8.3.	Securing of Tabs
(1)	[F61-OH1.1, OH1.2, OH1.3] [F61-OS2.3]
9.26.8.4.	Securing of Shingle Courses
(1)	[F61-OH1.1, OH1.2, OH1.3] [F61-OS2.3]
(2)	[F61-OH1.1, OH1.2, OH1.3] [F61-OS2.3]
(3)	[F61-OH1.1, OH1.2, OH1.3] [F61-OS2.3]
9.26.8.5.	Hips and Ridges
(1)	[F61-OH1.1, OH1.2, OH1.3] [F61-OS2.3]
(2)	[F61, F80-OH1.1, OH1.2, OH1.3] [F61, F80-OS2.3]
9.26.8.6.	Flashing
(1)	

Acceptable Solution	Objectives and Functional Statements
9.26.8.7.	Fastening
(1)	
9.26.9.1.	Decking
(1)	
9.26.9.2.	Grade
(1)	[F61-OH1.1, OH1.2, OH1.3] [F61-OS2.3]
(2)	[F61-OH1.1, OH1.2, OH1.3] [F61-OS2.3]
9.26.9.3.	Size
(1)	[F61-OH1.1, OH1.2, OH1.3] [F61-OS2.3]
9.26.9.4.	Spacing and Joints
(1)	[F61-OH1.1, OH1.2, OH1.3] [F61-OS2.3]
9.26.9.5.	Fastening
(1)	[F20, F80-OH1.1, OH1.2, OH1.3] [F20, F80-OS2.3]
9.26.9.6.	Exposure
(1)	[F61-OH1.1, OH1.2, OH1.3] [F61-OS2.3]
9.26.9.7.	Flashing
(1)	
9.26.9.8.	Eave Protection
(1)	
9.26.10.1.	Size and Thickness
(1)	[F61-OH1.1, OH1.2, OH1.3] [F61-OS2.3]
9.26.10.2.	Underlay
(1)	[F61-OH1.1, OH1.2, OH1.3] [F61-OS2.3]
(2)	[F61-OH1.1, OH1.2, OH1.3] [F61-OS2.3]
(3)	[F61-OH1.1, OH1.2, OH1.3] [F61-OS2.3]
9.26.10.3.	Spacing and Joints
(1)	[F61-OH1.1, OH1.2, OH1.3] [F61-OS2.3]
9.26.10.4.	Fastening
(1)	[F20, F80-OH1.1, OH1.2, OH1.3] [F20, F80-OS2.3]
9.26.10.5.	Exposure
(1)	[F61-OH1.1, OH1.2, OH1.3] [F61-OS2.3]
9.26.10.6.	Flashing
(1)	
9.26.10.7.	Eave Protection
(1)	
9.26.10.8.	Grade
(1)	[F61-OH1.1, OH1.2, OH1.3] [F61-OS2.3]

Acceptable Solution	Objectives and Functional Statements
9.26.11.1.	Quantity of Materials
(1)	[F61-OH1.1, OH1.2, OH1.3] [F61-OS2.3]
9.26.11.2.	Coal-Tar and Asphalt Products
(1)	[F61, F80-OH1.1, OH1.2, OH1.3] [F61, F80-OS2.3]
9.26.11.3.	Roof Felts
(1)	[F20-OH1.1, OH1.2, OH1.3] [F20-OS2.3]
9.26.11.4.	Aggregate Surfacing
(1)	[F61-OH1.1, OH1.2, OH1.3] [F61-OS2.3]
(2)	[F61-OH1.1, OH1.2, OH1.3] [F61-OS2.3]
9.26.11.5.	Flashing
(1)	
9.26.11.6.	Number of Layers
(1)	[F20, F80-OH1.1, OH1.2, OH1.3] [F20, F80-OS2.3]
9.26.11.7.	Installation of Layers
(1)	[F20-OH1.1, OH1.2, OH1.3] [F20-OS2.3]
(2)	[F61, F81-OH1.1, OH1.2, OH1.3] [F61, F81-OS2.3]
(3)	[F20-OH1.1, OH1.2, OH1.3] [F20-OS2.3]
9.26.11.8.	Roofing over Wood-Based Sheathing
(1)	[F61-OH1.1, OH1.2, OH1.3] [F61-OS2.3]
(2)	[F61-OH1.1, OH1.2, OH1.3] [F61-OS2.3]
9.26.11.9.	Attachment to Decking
(1)	[F61-OH1.1, OH1.2, OH1.3] [F61-OS2.3]
9.26.11.10.	Cant Strips
(1)	[F61-OH1.1, OH1.2, OH1.3] [F61-OS2.3] [F61-OS3.1]
(2)	[F61-OH1.1, OH1.2, OH1.3] [F61-OS2.3]
(3)	[F61-OH1.1, OH1.2, OH1.3] [F61-OS2.3]
(4)	[F61-OH1.1, OH1.2, OH1.3] [F61-OS2.3] [F61-OS3.1]
(5)	[F61-OH1.1, OH1.2, OH1.3] [F61-OS2.3]
(6)	[F61-OH1.1, OH1.2, OH1.3] [F61-OS2.3]
9.26.12.1.	Double Coverage
(1)	[F61, F80-OH1.1, OH1.2, OH1.3] [F61, F80-OS2.3]

Acceptable Solution	Objectives and Functional Statements
9.26.12.2.	Joints
(1)	[F61-OH1.1, OH1.2, OH1.3] [F61-OS2.3]
9.26.13.1.	Thickness
(1)	[F61, F80-OH1.1, OH1.2, OH1.3] [F61, F80-OS2.3]
9.26.13.2.	Support
(1)	[F20-OP2.1, OP2.3] [F22-OP2.3, OP2.4] [F20-OS2.1, OS2.3] [F22-OS2.3, OS2.4] [F20, F22-OH1.1, OH1.2, OH1.3]
9.26.14.1.	Support
(1)	[F20-OS2.1, OS2.3] [F22-OS2.3, OS2.4] [F20, F22-OH1.1, OH1.2, OH1.3]
9.26.15.1.	Installation
(1)	[F61, F80-OH1.1, OH1.2, OH1.3] [F61, F80-OS2.3]
9.26.16.1.	Installation
(1)	[F61, F80-OH1.1, OH1.2, OH1.3] [F61, F80-OS2.3]
9.26.17.1.	Installation
(1)	[F61-OH1.1, OH1.2, OH1.3] [F61-OS2.3]
9.26.18.1.	Roof Drains
(1)	
9.26.18.2.	Downspouts
(1)	[F61-OH1.1, OH1.2, OH1.3] [F61-OS2.3]
9.27.1.1.	General
(1)	
(2)	
(3)	
(4)	
r3.1 (5)	
r3.1 (6)	
9.27.2.1.	Minimizing and Preventing Ingress and Damage
r3 (1)	[F61-OH1.1, OH1.2, OH1.3] [F61-OS2.3]
r3 (2)	[F80, F81-OH1.1, OH1.2, OH1.3] [F80, F81-OS2.3]
r3 9.27.2.2.	Minimum Protection from Precipitation Ingress
(1)	[F61-OH1.1, OH1.2, OH1.3] [F61-OS2.3]
r3 9.27.2.3.	First and Second Planes of Protection
(1)	[F61, F62-OH1.1, OH1.2, OH1.3] [F61, F62-OS2.3]
r3 9.27.2.4.	Protection of Cladding from Moisture
(1)	[F61, F80-OH1.1, OH1.2, OH1.3] [F61, F80-OS2.3]
(2)	[F61-OH1.1, OH1.2, OH1.3] [F61, F80-OS2.3]

	Acceptable Solution	Objectives and Functional Statements
R3	9.27.3.1.	Elements of the Second Plane of Protection
	(1)	[F61, F62-OH1.1, OH1.2, OH1.3] [F61, F62-OS2.3]
	(2)	
	(3)	[F61, F62-OH1.1, OH1.2, OH1.3] [F61, F62-OS2.3]
	(4)	
R3	9.27.3.2.	Sheathing Membrane Material Standard
	(1)	[F20, F55, F61, F62-OH1.1, OH1.2, OH1.3] [F20, F55, F61, F62-OS2.3]
R3	9.27.3.3.	Required Sheathing Membrane and Installation
	(1)	[F55, F61-OH1.1, OH1.2, OH1.3] [F55, F61-OS2.3]
	(2)	[F55, F61-OH1.1, OH1.2, OH1.3] [F55, F61-OS2.3]
	(3)	[F61-OH1.1, OH1.2, OH1.3] [F61-OS2.3]
R3	9.27.3.4.	Insulating Sheathing in Lieu of Sheathing Membrane
	(1)	
	(2)	[F55, F61-OH1.1, OH1.2, OH1.3] [F55, F61-OS2.3]
R3	9.27.3.5.	Sheathing Membranes in Lieu of Sheathing
	(1)	[F55, F61-OH1.1, OH1.2, OH1.3] [F55, F61-OS2.3]
	(2)	[F55, F61-OH1.1, OH1.2, OH1.3] [F55, F61-OS2.3]
	(3)	
R3	9.27.3.6.	Face Sealed Cladding
	(1)	
	(2)	[F20, F55, F61-OH1.1, OH1.2, OH1.3] [F20, F55, F61-OS2.3]
	(3)	[F55, F61-OH1.1, OH1.2, OH1.3] [F55, F61-OS2.3]
R3	9.27.3.7.	Flashing Materials
	(1)	[F61, F62, F80-OH1.1, OH1.2, OH1.3] [F61, F62, F80-OS2.3]
	9.27.3.8.	Flashing Installation
	(1)	(a), (b), (c)(i) [F61-OH1.1, OH1.2, OH1.3] (a), (b), (c)(i) [F61-OS2.3] (c)(ii) [F61, F62-OH1.1, OH1.2, OH1.3] (c)(ii) [F61, F62-OS2.3]
	(2)	(a), (b)(ii), (c)(i) [F61-OH1.1, OH1.2, OH1.3] Applies to detailing of horizontal joints. (a), (b)(ii), (c)(i) [F61-OS2.3] Applies to detailing of horizontal joints. (b)(i), (c)(ii) [F61, F62-OH1.1, OH1.2, OH1.3] Applies to cladding installed outboard of a drained and vented air space. (b)(i), (c)(ii) [F61, F62-OS2.3] Applies to cladding installed outboard of a drained and vented air space.
	(3)	[F61, F62-OH1.1, OH1.2, OH1.3] [F61, F62-OS2.3]
	(4)	[F61, F62-OH1.1, OH1.2, OH1.3] [F61, F62-OS2.3]

Acceptable Solution	Objectives and Functional Statements
(5)	[F61, F62-OH1.1, OH1.2, OH1.3] [F61, F62-OS2.3]
9.27.4.1. Required Sealants	
(1)	[F61-OH1.1, OH1.2, OH1.3] [F61-OS2.3]
(2)	[F61-OH1.1, OH1.2, OH1.3] [F61-OS2.3]
(3)	[F61-OH1.1, OH1.2, OH1.3] [F61-OS2.3]
9.27.4.2. Materials	
(1)	[F80-OH1.1, OH1.2, OH1.3] [F80-OS2.3]
(2)	[F80-OH1.1, OH1.2, OH1.3] [F80-OS2.3]
(3)	[F80-OH1.1, OH1.2, OH1.3] [F80-OS2.3]
R11.1	9.27.5.1. Attachment
(1)	[F20-OH1.1, OH1.2, OH1.3] [F20, F22-OH1.1, OH1.2, OH1.3] Applies where panel-type cladding is installed to provide the required bracing. [F20-OP2.1, OP2.3, OP2.4] [F22-OP2.3, OP2.4, OP2.5] Applies where panel-type cladding is installed to provide the required bracing. [F20-OS2.1, OS2.3] [F20-OS2.1, OS2.3, OS2.4] [F22-OS2.3, OS2.4, OS2.5] Applies where panel-type cladding is installed to provide the required bracing. [F20, F22-OH4] Applies where panel-type cladding is installed to provide the required bracing of walls that support floors. [F20, F22-OS3.1] Applies where panel-type cladding is installed to provide the required bracing of walls that support floors. [F20, F22-OS3.7] Applies where panel-type cladding is installed to provide bracing of walls that contain doors or windows required for emergency egress.
(2)	[F20-OH1.1, OH1.2, OH1.3] [F20-OS2.1, OS2.3]
(3)	[F20-OH1.1, OH1.2, OH1.3] [F20-OS2.3]
(4)	[F20-OH1.1, OH1.2, OH1.3] [F20-OS2.1, OS2.3]
9.27.5.2. Blocking	
(1)	[F20-OH1.1, OH1.2, OH1.3] [F20, F22-OH1.1, OH1.2, OH1.3] Applies where panel-type cladding is installed to provide the required bracing. [F20-OP2.1, OP2.3, OP2.4][F22-OP2.3, OP2.4, OP2.5] Applies where panel-type cladding is installed to provide the required bracing. [F20-OS2.1, OS2.3] [F20-OS2.1, OS2.3, OS2.4] [F22-OS2.3, OS2.4, OS2.5] Applies where panel-type cladding is installed to provide the required bracing.

This Page
Intentionally Left Blank

Acceptable Solution	Objectives and Functional Statements
9.27.5.3.	Furring
(1)	[F20-OH1.1, OH1.2, OH1.3] [F20-OS2.1, OS2.3] [F20-OS2.1, OS2.3, OS2.4] [F22-OS2.3, OS2.4, OS2.5] Applies where furring is used for the attachment if panel-type cladding installed to provide the required bracing.
(2)	[F20-OH1.1, OH1.2, OH1.3] [F20, F22-OH1.1, OH1.2, OH1.3] Applies where furring is used for the attachment of panel-type cladding installed to provide the required bracing. [F20-OS2.1, OS2.3] [F20-OS2.1, OS2.3, OS2.4] [F22-OS2.3, OS2.4, OS2.5] Applies where furring is used for the attachment of panel-type cladding installed to provide the required bracing.
(3)	[F20-OH1.1, OH1.2, OH1.3] [F20, F22-OH1.1, OH1.2, OH1.3] Applies where furring is used for the attachment of panel-type cladding installed to provide the required bracing. [F20-OS2.1, OS2.3] [F20-OS2.1, OS2.3, OS2.4] [F22-OS2.3, OS2.4, OS2.5] Applies where furring is used for the attachment of panel-type cladding installed to provide the required bracing.
9.27.5.4.	Size and Spacing of Fasteners
(1)	[F20-OH1.1, OH1.2, OH1.3] [F20, F22-OH1.1, OH1.2, OH1.3] Applies to the attachment of panel-type cladding installed to provide the required bracing. [F20-OS2.1, OS2.3] [F20-OS2.1, OS2.3, OS2.4] [F22-OS2.3, OS2.4, OS2.5] Applies where panel-type cladding is installed to provide the required bracing.
9.27.5.5.	Fastener Materials
(1)	[F80-OH1.1, OH1.2, OH1.3] [F80-OP2.1, OP2.3, OP2.4, OP2.5] Applies where panel-type cladding is installed to provide the required bracing. [F80-OS2.3] [F80-OS2.3, OS2.4] Applies where panel-type cladding is installed to provide required bracing.
9.27.5.6.	Expansion and Contraction
(1)	[F21-OH1.1, OH1.2, OH1.3] [F21-OS2.3]
9.27.5.7.	Penetration of Fasteners
(1)	[F20-OH1.1, OH1.2, OH1.3] [F20-OS2.1, OS2.3]
(2)	[F20-OH1.1, OH1.2, OH1.3] [F20, F22-OH1.1, OH1.2, OH1.3] Applies where panel-type cladding is installed to provide the required bracing. [F20-OP2.1, OP2.3, OP2.4] [F22-OP2.3, OP2.4, OP2.5] Applies where panel-type cladding is installed to provide the required bracing. [F20-OS2.1, OS2.3] [F20-OS2.1, OS2.3, OS2.4] [F22-OS2.3, OS2.4, OS2.5] Applies where panel-type cladding is installed to provide the required bracing.
9.27.6.1.	Materials
(1)	[F20, F61-OH1.1, OH1.2, OH1.3] [F20, F62-OS2.3]
9.27.6.2.	Thickness and Width
(1)	[F20-OH1.1, OH1.2, OH1.3] [F20-OS2.3]
(2)	[F20-OH1.1, OH1.2, OH1.3] [F20-OS2.3]
(3)	[F20-OH1.1, OH1.2, OH1.3] [F20-OS2.3]
9.27.6.3.	Joints
(1)	[F61-OH1.1, OH1.2, OH1.3] [F61-OS2.3]

Acceptable Solution	Objectives and Functional Statements
(2)	[F21, F61-OH1.1, OH1.2, OH1.3] [F21, F61-OS2.3]
9.27.7.1.	Materials
(1)	[F61-OH1.1, OH1.1, OH1.3] [F61-OS2.3]
(2)	[F20, F61-OH1.1, OH1.2, OH1.3] [F20, F61-OS2.3]
(3)	[F20, F61-OH1.1, OH1.2, OH1.3] [F20, F61-OS2.3]
9.27.7.2.	Width
(1)	[F20, F61-OH1.1, OH1.2, OH1.3] [F20, F61-OS2.3]
9.27.7.3.	Fasteners
(1)	[F20, F61-OH1.1, OH1.2, OH1.3] [F20, F61-OS2.3]
9.27.7.4.	Offsetting of Joints
(1)	[F61-OH1.1, OH1.2, OH1.3] [F61-OS2.3]
(2)	[F61-OH1.1, OH1.2, OH1.3] [F61-OS2.3]
9.27.7.5.	Fastening to Lath
(1)	[F81-OH1.1, OH1.2, OH1.3] [F81-OS2.3]
(2)	[F62-OH1.1, OH1.2, OH1.3] [F62-OS2.3]
(3)	[F20-OH1.1, OH1.2, OH1.3] [F20-OS2.3]
(4)	[F20-OH1.1, OH1.2, OH1.3] [F20-OS2.3]
(5)	[F62-OH1.1, OH1.2, OH1.3] [F62-OS2.3]
9.27.7.6.	Exposure and Thickness
(1)	[F20, F62-OH1.1, OH1.2, OH1.3] [F20, F62-OS2.3]
9.27.8.1.	Material Standards
(1)	[F20-OP2.1, OP2.3, OP2.4] [F22-OP2.3, OP2.4, OP2.5] Applies where panel-type cladding is installed to provide the required bracing. [F20-OS2.1, OS2.3] [F20-OS2.1, OS2.3, OS2.4] [F22-OS2.3, OS2.4, OS2.5] Applies where panel-type cladding is installed to provide required bracing. [F20, F22-OH1.1, OH1.2, OH1.3]
9.27.8.2.	Thickness
(1)	[F20, F22-OH1.1, OH1.2, OH1.3] [F20, F22-OS2.1, OS2.3] [F20-OS2.1, OS2.3, OS2.4] [F22-OS2.3, OS2.4, OS2.5] Applies where panel-type cladding is installed to provide required bracing.
(2)	[F20-OP2.1, OP2.3] [F22-OP2.3, OP2.4, OP2.5] Applies where panel-type cladding is installed to provide the required bracing. [F20-OS2.1, OS2.3] [F20-OS2.1, OS2.3, OS2.4] [F22-OS2.3, OS2.4, OS2.5] Applies where panel-type cladding is installed to provide the required bracing. [F20, F22-OH1.1, OH1.2, OH1.3]
(3)	

Acceptable Solution	Objectives and Functional Statements
9.27.8.3.	Edge Treatment
(1)	[F61-OH1.1, OH1.2, OH1.3] [F61-OP2.3, OP2.4, OP2.5] Applies where panel-type cladding is installed to provide the required bracing. [F61-OS2.3] [F61-OS2.3, OS2.4, OS2.5] Applies where panel-type cladding is installed to provide the required bracing.
9.27.8.4.	Panel Cladding
(1)	[F20, F22-OH1.1, OH1.2, OH1.3] [F20-OP2.1, OP2.3, OP2.4] [F22-OP2.3, OP2.4, OP2.5] Applies where panel-type cladding is installed to provide the required bracing. [F20, F22-OS2.1, OS2.3] [F20-OS2.1, OS2.3, OS2.4] [F22-OS2.3, OS2.4, OS2.5] Applies where panel-type cladding is installed to provide the required bracing.
(2)	[F21-OH1.1, OH1.2, OH1.3] [F21-OS2.3]
(3)	[F61-OH1.1, OH1.2, OH1.3] [F61-OS2.3]
(4)	[F61-OH1.1, OH1.2, OH1.3] [F61-OS2.3]
9.27.8.5.	Lapped Strip Siding
(1)	[F21, F61-OH1.1, OH1.2, OH1.3] [F21, F61-OS2.3]
(2)	[F61-OH1.1, OH1.2, OH1.3] [F61-OS2.3]
(3)	[F61-OH1.1, OH1.2, OH1.3] [F61-OS2.3]
9.27.9.1.	Material Standards
(1)	[F20, F22-OH1.1, OH1.2, OH1.3] [F20-OS2.1, OS2.3] [F20-OS2.1, OS2.3, OS2.4] [F22-OS2.3, OS2.4, OS2.5] Applies where panel-type cladding is installed to provide the required bracing.
(2)	[F20, F22-OH1.1, OH1.2, OH1.3] [F20-OS2.1, OS2.3] [F22-OS2.3, OS2.4, OS2.5] Applies where panel-type cladding is installed to provide the required bracing.
9.27.9.2.	Thickness
(1)	[F20, F22-OH1.1, OH1.2, OH1.3] [F20-OP2.1, OP2.3, OP2.4] [F22-OP2.3, OP2.4, OP2.5] Applies where panel-type cladding is installed to provide the required bracing. [F20, F22-OS2.1, OS2.3] [F20-OS2.1, OS2.3, OS2.4] [F22-OS2.3, OS2.4, OS2.5] Applies where panel-type cladding is installed to provide the required bracing.
(2)	[F20, F22-OH1.1, OH1.2, OH1.3] [F20, F22-OS2.1, OS2.3] [F20-OS2.1, OS2.3, OS2.4] [F22-OS2.3, OS2.4, OS2.5] Applies where panel-type cladding is installed to provide the required bracing.
(3)	[F20-OP2.1, OP2.3, OP2.4] [F22-OP2.3, OP2.4, OP2.5] Applies where panel-type cladding is installed to provide the required bracing. [F20, F22-OH1.1, OH1.2, OH1.3] [F20, F22-OS2.1, OS2.3] [F20-OS2.1, OS2.3, OS2.4] [F22-OS2.3, OS2.4, OS2.5] Applies where panel-type cladding is installed to provide the required bracing.
9.27.9.3.	Panel Cladding
(1)	[F20-OP2.1, OP2.3, OP2.4] [F22-OP2.3, OP2.4, OP2.5] Applies where panel-type cladding is installed to provide the required bracing. [F20, F21, F22-OH1.1, OH1.2, OH1.3]

Acceptable Solution	Objectives and Functional Statements
(1) (Cont'd)	[F20, F21, F22-OS2.1, OS2.3] [F20-OS2.1, OS2.3, OS2.4] [F33-OS2.3, OS2.4, OS2.5] Applies where panel-type cladding is installed to provide the required bracing.
(2)	[F61-OH1.1, OH1.2, OH1.3] [F61-OS2.3]
(3)	[F61-OH1.1, OH1.2, OH1.3] [F61-OS2.3]
9.27.9.4.	Lapped Strip Siding
(1)	[F61-OH1.1, OH1.2, OH1.3] [F61-OS2.3]
(2)	[F61-OH1.1, OH1.2, OH1.3] [F61-OS2.3]
9.27.9.5.	Clearance
(1)	[F21-OH1.1, OH1.2, OH1.3] [F21-OP2.1, OP2.3, OP2.4, OP2.5] Applies where panel-type cladding is installed to provide the required bracing. [F21-OS2.1, OS2.3] [F21-OS2.1, OS2.3, OS2.4, OS2.5] Applies where panel-type cladding is installed to provide the required bracing.
9.27.10.1.	Material Standard
(1)	[F20, F22-OH1.1, OH1.2, OH1.3] [F20-OS2.1, OS2.3] [F20-OS2.1, OS2.3, OS2.4] Applies where panel-type cladding is installed to provide required bracing.
9.27.10.2.	Thickness
(1)	[F20, F22-OH1.1, OH1.2, OH1.3] [F20, 22-OS2.1, OS2.3] [F20-OS2.1, OS2.3, OS2.4] [F22-OS2.3, OS2.4, OS2.5] Applies where panel-type cladding is installed to provide the required bracing.
(2)	[F20-OP2.1, OP2.3, OP2.4] [F22-OP2.3, OP2.4, OP2.5] Applies where panel-type cladding is installed to provide the required bracing. [F20, F22-OH1.1, OH1.2, OH1.3] [F20, F22-OS2.1, OS2.3] [F20-OS2.1, OS2.3, OS2.4] [F22-OS2.3, OS2.4, OS2.5] Applies where panel-type cladding is installed to provide the required bracing.
(3)	[F20, F22-OH1.1, OH1.2, OH1.3] [F20, 22-OS2.1, OS2.3] [F20-OS2.1, OS2.3, OS2.4] [F22-OS2.3, OS2.4, OS2.5] Applies where panel-type cladding is installed to provide the required bracing.
(4)	[F20-OP2.1, OP2.3, OP2.4] [F22-OP2.3, OP2.4, OP2.5] Applies where panel-type cladding is installed to provide the required bracing. [F20, F22-OH1.1, OH1.2, OH1.3] [F20, F22-OS2.1, OS2.3] [F20-OS2.1, OS2.3, OS2.4] [F22-OS2.3, OS2.4, OS2.5] Applies where panel-type cladding is installed to provide the required bracing.
9.27.10.3.	Panel Cladding
(1)	[F20, F22, F80-OH1.1, OH1.2, OH1.3] [F20, F22, F80-OS2.1, OS2.3] [F20, F80-OS2.1, OS2.3, OS2.4] [F22, F80-OS2.3, OS2.4, OS2.5] Applies where panel-type cladding is installed to provide the required bracing.
(2)	[F21-OH1.1, OH1.2, OH1.3] [F21-OS2.3]
(3)	[F61-OH1.1, OH1.2, OH1.3] [F61-OS2.3]
(4)	[F61-OH1.1, OH1.2, OH1.3] [F61-OS2.3]

Acceptable Solution	Objectives and Functional Statements
9.27.10.4.	Clearance
(1)	[F21-OH1.1, OH1.2, OH1.3] [F21-OP2.1, OP2.3, OP2.4, OP2.5] Applies where panel-type cladding is installed to provide the required bracing. [F21-OS2.1, OS2.3] [F21-OS2.1, OS2.3, OS2.4, OS2.5] Applies where panel-type cladding is installed to provide the required bracing.
9.27.11.1.	Material Standards
(1)	[F20-OS2.1, OS2.3] [F22, F61-OS2.3] [F20, F22, F61, F62-OH1.1, OH1.2, OH1.3]
(2)	[F20, F22, F61-OH1.1, OH1.2, OH1.3] [F20-OS2.1, OS2.3] [F22, F61-OS2.3] [F20-OS2.1, OS2.3, OS2.4] [F22-OS2.3, OS2.4, OS2.5] Applies where panel-type cladding is installed to provide the required bracing.
(3)	[F20-OS2.1, OS2.3] [F22, F61-OS2.3] [F20, F22, F61-OH1.1, OH1.2, OH1.3]
(4)	[F20, F22, F61-OH1.1, OH1.2, OH1.3] [F20-OS2.1, OS2.3] [F22, F61-OS2.3] [F20-OS2.1, OS2.3, OS2.4] [F22-OS2.3, OS2.4, OS2.5] Applies where panel-type cladding is installed to provide the required bracing.
9.27.12.1.	Material Standard
(1)	[F20, F61, F62-OH1.1, OH1.2, OH1.3] [F20, F61, F62-OS2.3]
9.27.12.2.	Attachment
(1)	
R3.1	9.27.13.1.
I11.1	Application
	(1)
	(2)
R3.1	9.27.13.2.
	Materials
	(1)
	[F20, F61, F62-OH1.1, OH1.2, OH1.3] [F20, F61, F62-OH2.3]
	(2)
	[F20, F22-OH1.1, OH1.2, OH1.3] [F20, F22-OS2.3]
R3.1	9.27.13.3.
	Design and Installation
	(1)
	[F20, F61, F62-OH1.1, OH1.2, OH1.3] [F20, F61, F62-OH2.3]
	(2)
	[F20, F61, F62-OH1.1, OH1.2, OH1.3] [F20, F61, F62-OH2.3]
	9.28.1.1.
	Sheathing Beneath Stucco
	(1)
	[F20, F22-OH1.1, OH1.2, OH1.3] [F20, F22-OS2.3]
	(2)
	9.28.1.2.
	Lath and Reinforcing
	(1)
	[F20-OH1.1, OH1.2, OH1.3] [F20-OS2.3]
	(2)
	[F20-OH1.1, OH1.2, OH1.3] [F20-OS2.3]
	(3)
	[F20, F21-OH1.1] [F20, F21-OP1.1] [F20, F21-OS1.1] [F20, F21-OS2.3] [F20, F21-OS3.4]

Acceptable Solution	Objectives and Functional Statements
9.28.1.3.	Concrete Masonry Units
(1)	[F80-OH1.1, OH1.2, OH1.3] [F80-OP1.1] Applies where stucco is applied to masonry <i>chimneys</i> . [F80-OS1.1] Applies where stucco is applied to masonry <i>chimneys</i> . [F80-OS2.3] [F80-OS3.4] Applies where stucco is applied to masonry <i>chimneys</i> .
9.28.1.4.	Clearance over Ground Level
(1)	[F80-OH1.1, OH1.2, OH1.3] [F80-OS2.3]
9.28.1.5.	Flashing and Sealants
(1)	[F80-OH1.1, OH1.2, OH1.3] Applies to the separation of aluminum flashing from stucco. [F80-OS2.3] Applies to the separation of aluminum flashing from stucco.
9.28.2.1.	Portland Cement
(1)	[F20-OH1.1, OH1.2, OH1.3] [F20-OP1.1] Applies where stucco is applied to masonry <i>chimneys</i> . [F20-OS1.1] Applies where stucco is applied to masonry <i>chimneys</i> . [F20-OS2.3] [F20-OS3.4] Applies where stucco is applied to masonry <i>chimneys</i> .
9.28.2.2.	Aggregate
(1)	[F80-OH1.1, OH1.2, OH1.3] [F80-OP1.1] Applies where stucco is applied to masonry <i>chimneys</i> . [F80-OS1.1] Applies where stucco is applied to masonry <i>chimneys</i> . [F80-OS2.3] [F80-OS3.4] Applies where stucco is applied to masonry <i>chimneys</i> .
(2)	[F20, F80-OH1.1, OH1.2, OH1.3] [F20, F80-OP1.1] Applies where stucco is applied to masonry <i>chimneys</i> . [F20, F80-OS1.1] Applies where stucco is applied to masonry <i>chimneys</i> . [F20, F80-OS2.3] [F20, F80-OS3.4] Applies where stucco is applied to masonry <i>chimneys</i> .
9.28.2.3.	Water
(1)	[F80-OH1.1, OH1.2, OH1.3] [F80-OP1.1] Applies where stucco is applied to masonry <i>chimneys</i> . [F80-OS1.1] Applies where stucco is applied to masonry <i>chimneys</i> . [F80-OS2.3] [F80-OS3.4] Applies where stucco is applied to masonry <i>chimneys</i> .
9.28.3.1.	Materials
(1)	[F80-OH1.1, OH1.2, OH1.3] [F80-OP1.1] Applies where stucco is applied to masonry <i>chimneys</i> . [F80-OS1.1] Applies where stucco is applied to masonry <i>chimneys</i> . [F80-OS2.3] [F80-OS3.4] Applies where stucco is applied to masonry <i>chimneys</i> .
9.28.3.2.	Nails and Staples
(1)	[F20-OH1.1, OH1.2, OH1.3] [F20-OP1.1] Applies where stucco is applied to masonry <i>chimneys</i> . [F20-OS1.1] Applies where stucco is applied to masonry <i>chimneys</i> . [F20-OS2.3] [F20-OS3.4] Applies where stucco is applied to masonry <i>chimneys</i> .
(2)	[F20-OH1.1, OH1.2, OH1.3] [F20-OS2.3]

Acceptable Solution	Objectives and Functional Statements
(3)	[F20-OH1.1, OH1.2, OH1.3]
	[F20-OP1.1] Applies where stucco is applied to masonry <i>chimneys</i> .
	[F20-OS1.1] Applies where stucco is applied to masonry <i>chimneys</i> .
	[F20-OS2.3]
	[F20-OS3.4] Applies where stucco is applied to masonry <i>chimneys</i> .
(4)	[F20-OS2.1]
9.28.4.1.	Materials
(1)	[F80-OH1.1, OH1.2, OH1.3]
	[F80-OP1.1] Applies where stucco is applied to masonry <i>chimneys</i> .
	[F80-OS1.1] Applies where stucco is applied to masonry <i>chimneys</i> .
	[F80-OS2.3]
	[F80-OS3.4] Applies where stucco is applied to masonry <i>chimneys</i> .
(2)	[F80-OH1.1, OH1.2, OH1.3]
	[F80-OP1.1] Applies where stucco is applied to masonry <i>chimneys</i> .
	[F80-OS1.1] Applies where stucco is applied to masonry <i>chimneys</i> .
	[F80-OS2.3]
	[F80-OS3.4] Applies where stucco is applied to masonry <i>chimneys</i> .

This Page
Intentionally Left Blank

Acceptable Solution	Objectives and Functional Statements
9.28.4.2.	No Sheathing Required
(1)	[F20-OH1.1, OH1.2, OH1.3] [F20-OS2.3]
9.28.4.3.	Stucco Lath Specifications
(1)	[F20-OH1.1, OH1.2, OH1.3] [F20-OP1.1] Applies where stucco is applied to masonry <i>chimneys</i> . [F20-OS1.1] Applies where stucco is applied to masonry <i>chimneys</i> . [F20-OS2.3] [F20-OS3.4] Applies where stucco is applied to masonry <i>chimneys</i> .
9.28.4.4.	Self-Furring Devices
(1)	[F20, F80-OH1.1, OH1.2, OH1.3] [F20, F80-OP1.1] Applies where stucco is applied to masonry <i>chimneys</i> . [F20, F80-OS1.1] Applies where stucco is applied to masonry <i>chimneys</i> . [F20, F80-OS2.3] [F20, F80-OS3.4] Applies where stucco is applied to masonry <i>chimneys</i> .
9.28.4.5.	Application of Stucco Lath
(1)	[F20-OH1.1, OH1.2, OH1.3] [F20-OP1.1] Applies where stucco is applied to masonry <i>chimneys</i> . [F20-OS1.1] Applies where stucco is applied to masonry <i>chimneys</i> . [F20-OS2.3] [F20-OS3.4] Applies where stucco is applied to masonry <i>chimneys</i> .
(2)	[F20-OH1.1, OH1.2, OH1.3] [F20-OP1.1] Applies where stucco is applied to masonry <i>chimneys</i> . [F20-OS1.1] Applies where stucco is applied to masonry <i>chimneys</i> . [F20-OS2.3] [F20-OS3.4] Applies where stucco is applied to masonry <i>chimneys</i> .
(3)	[F20-OH1.1, OH1.2, OH1.3] [F20-OS2.3]
(4)	[F20-OH1.1, OH1.2, OH1.3] [F20-OP1.1] Applies where stucco is applied to masonry <i>chimneys</i> . [F20-OS1.1] Applies where stucco is applied to masonry <i>chimneys</i> . [F20-OS2.3] [F20-OS3.4] Applies where stucco is applied to masonry <i>chimneys</i> .
9.28.4.6.	Fastening
(1)	
(2)	[F20-OH1.1, OH1.2, OH1.3] [F20-OP1.1] Applies where stucco is applied to masonry <i>chimneys</i> . [F20-OS1.1] Applies where stucco is applied to masonry <i>chimneys</i> . [F20-OS2.3] [F20-OS3.4] Applies where stucco is applied to masonry <i>chimneys</i> .
(3)	[F20-OH1.1, OH1.2, OH1.3] [F20-OP1.1] Applies where stucco is applied to masonry <i>chimneys</i> . [F20-OS1.1] Applies where stucco is applied to masonry <i>chimneys</i> . [F20-OS2.3] [F20-OS3.4] Applies where stucco is applied to masonry <i>chimneys</i> .
(4)	[F20-OS2.1]
9.28.5.1.	Mixes
(1)	[F20, F61, F80-OH1.1, OH1.2, OH1.3] [F20, F61, F80-OP1.1] Applies where stucco is applied to masonry <i>chimneys</i> . [F20, F61, F80-OS1.1] Applies where stucco is applied to masonry <i>chimneys</i> . [F20, F61, F80-OS2.3] [F20, F61, F80-OS3.4] Applies where stucco is applied to masonry <i>chimneys</i> .

Acceptable Solution	Objectives and Functional Statements
9.28.5.2.	Pigments
(1)	[F20, F80-OH1.1, OH1.2, OH1.3] [F20, F80-OP1.1] Applies where stucco is applied to masonry <i>chimneys</i> . [F20, F80-OS1.1] Applies where stucco is applied to masonry <i>chimneys</i> . [F20, F80-OS2.3] [F20, F80-OS3.4] Applies where stucco is applied to masonry <i>chimneys</i> .
(2)	[F20, F80-OH1.1, OH1.2, OH1.3] [F20, F80-OS2.3]
9.28.5.3.	Mixing
(1)	[F20, F80-OH1.1, OH1.2, OH1.3] [F20, F80-OP1.1] Applies where stucco is applied to masonry <i>chimneys</i> . [F20, F80-OS1.1] Applies where stucco is applied to masonry <i>chimneys</i> . [F20, F80-OS2.3] [F20, F80-OS3.4] Applies where stucco is applied to masonry <i>chimneys</i> .
(2)	[F20, F80-OH1.1, OH1.2, OH1.3] [F20, F80-OP1.1] Applies where stucco is applied to masonry <i>chimneys</i> . [F20, F80-OS1.1] Applies where stucco is applied to masonry <i>chimneys</i> . [F20, F80-OS2.3] [F20, F80-OS3.4] Applies where stucco is applied to masonry <i>chimneys</i> .
9.28.6.1.	Low Temperature Conditions
(1)	[F20, F80-OH1.1, OH1.2, OH1.3] [F20, F80-OP1.1] Applies where stucco is applied to masonry <i>chimneys</i> . [F20, F80-OS1.1] Applies where stucco is applied to masonry <i>chimneys</i> . [F20, F80-OS2.3]. [F20, F80-OS3.4] Applies where stucco is applied to masonry <i>chimneys</i> .
(2)	[F20, F80-OH1.1, OH1.2, OH1.3] [F20, F80-OP1.1] Applies where stucco is applied to masonry <i>chimneys</i> . [F20, F80-OS1.1] Applies where stucco is applied to masonry <i>chimneys</i> . [F20, F80-OS2.3] [F20, F80-OS3.4] Applies where stucco is applied to masonry <i>chimneys</i> .
9.28.6.2.	Number of Coats and Total Thickness
(1)	[F20, F80-OH1.1, OH1.2, OH1.3] [F20, F80-OP1.1] Applies where stucco is applied to masonry <i>chimneys</i> . [F20, F80-OS1.1] Applies where stucco is applied to masonry <i>chimneys</i> . [F20, F80-OS2.3] [F20, F80-OS3.4] Applies where stucco is applied to masonry <i>chimneys</i> .
9.28.6.3.	First Coat
(1)	[F20, F80-OH1.1, OH1.2, OH1.3] [F20, F80-OP1.1] Applies where stucco is applied to masonry <i>chimneys</i> . [F20, F80-OS1.1] Applies where stucco is applied to masonry <i>chimneys</i> . [F20, F80-OS2.3] [F20, F80-OS3.4] Applies where stucco is applied to masonry <i>chimneys</i> .
(2)	[F20-OH1.1, OH1.2, OH1.3] [F20-OP1.1] Applies where stucco is applied to masonry <i>chimneys</i> . [F20-OS1.1] Applies where stucco is applied to masonry <i>chimneys</i> . [F20-OS2.3] [F20-OS3.4] Applies where stucco is applied to masonry <i>chimneys</i> .
9.28.6.4.	Second Coat
(1)	[F20-OH1.1, OH1.2, OH1.3] [F20-OP1.1] Applies where stucco is applied to masonry <i>chimneys</i> . [F20-OS1.1] Applies where stucco is applied to masonry <i>chimneys</i> . [F20-OS2.3]

Acceptable Solution	Objectives and Functional Statements
(1) (Cont'd)	[F20-OS3.4] Applies where stucco is applied to masonry <i>chimneys</i> .
(2)	[F20-OH1.1, OH1.2, OH1.3]
	[F20-OP1.1] Applies where stucco is applied to masonry <i>chimneys</i> .
	[F20-OS1.1] Applies where stucco is applied to masonry <i>chimneys</i> .
	[F20-OS2.3]
	[F20-OS3.4] Applies where stucco is applied to masonry <i>chimneys</i> .
9.28.6.5.	Finish Coat
(1)	[F80-OH1.1, OH1.2, OH1.3]
	[F80-OP1.1] Applies where stucco is applied to masonry <i>chimneys</i> .
	[F80-OS1.1] Applies where stucco is applied to masonry <i>chimneys</i> .
	[F80-OS2.3]
	[F80-OS3.4] Applies where stucco is applied to masonry <i>chimneys</i> .
(2)	[F20-OH1.1, OH1.2, OH1.3]
	[F20-OP1.1] Applies where stucco is applied to masonry <i>chimneys</i> .
	[F20-OS1.1] Applies where stucco is applied to masonry <i>chimneys</i> .
	[F20-OS2.3]
	[F20-OS3.4] Applies where stucco is applied to masonry <i>chimneys</i> .
(3)	[F80-OH1.1, OH1.2, OH1.3]
	[F80-OP1.1] Applies where stucco is applied to masonry <i>chimneys</i> .
	[F80-OS1.1] Applies where stucco is applied to masonry <i>chimneys</i> .
	[F80-OS2.3]
	[F80-OS3.4] Applies where stucco is applied to masonry <i>chimneys</i> .
9.29.1.1.	Fire Protection and Sound Control
(1)	
9.29.2.1.	Where Required
(1)	[F80, F81-OP2.3, OP2.4]
	[F80, F81-OS2.3]
	[F80, F81-OH1.1, OH1.2] Applies where interior finishes support or serve as required environmental separation elements.
	[F80, F81-OS1.2] Applies where interior finishes are required to act as fire protection for foamed plastics or to contribute to the required fire resistance of assemblies.
9.29.2.2.	Materials
(1)	[F80-OP2.3, OP2.4]
	[F80-OS1.2] Applies where interior finishes are required to act as fire protection for foamed plastics or to contribute to the required fire resistance of assemblies.
	[F80-OS2.3]
	[F80, F81-OH1.1, OH1.2] Applies where interior finishes support or serve as required environmental separation elements.
9.29.3.1.	Size and Spacing of Furring
(1)	[F20, F22-OP2.1, OP2.4]
	[F20, F22-OH1.1, OH1.2] Applies where interior finishes support or serve as required environmental separation elements.
	[F20, F22-OS1.2] Applies where interior finishes are required to act as fire protection for foamed plastics or to contribute to the required fire resistance of assemblies.
	[F20, F22-OS2.1]
9.29.3.2.	Fastening
(1)	[F20-OP2.1, OP2.4]
	[F20-OH1.1, OH1.2] Applies where interior finishes support or serve as required environmental separation elements.
	[F20-OS1.2] Applies where interior finishes are required to act as fire protection for foamed plastics or to contribute to the required fire resistance of assemblies.
	[F20-OS2.1]

Acceptable Solution	Objectives and Functional Statements
9.29.4.1.	Application
(1)	[F20, F80-OS2.1, OS2.3] [F20, F80-OP2.1, OP2.3] [F22, F80-OP2.4] [F20, F22, F81, F90-OH1.1, OH1.2] Applies where interior finishes support or serve as required environmental separation elements. [F20, F80-OS1.2] Applies where interior finishes are required to act as fire protection for foamed plastics or to contribute to the required fire resistance of assemblies.
9.29.5.1.	Application
(1)	[F20, F80-OP2.1, OP2.3] [F22, F80-OP2.4] [F20, F22, F80-OS1.2] Applies where interior finishes are required to act as fire protection for foamed plastics or to contribute to the required fire resistance of assemblies. [F20, F80-OS2.1, OS2.3] [F20, F22, F80, F81-OH1.1, OH1.2] Applies where interior finishes support or serve as required environmental separation elements.
(2)	
9.29.5.2.	Materials
(1)	[F20, F80-OP2.1, OP2.3] [F22, F80-OP2.4] [F20, F22, F80-OS1.2] Applies where interior finishes are required to act as fire protection for foamed plastics or to contribute to the required fire resistance of assemblies. [F20, F80-OS2.1, OS2.3] [F20, F22, F80, F81-OH1.1, OH1.2] Applies where interior finishes support or serve as required environmental separation elements.
9.29.5.3.	Maximum Spacing of Supports
(1)	[F20-OP2.1] [F20, F22-OP2.4] [F20, F22-OH1.1, OH1.2] Applies where interior finishes support or serve as required environmental separation elements. [F20, F22-OS1.2] Applies where interior finishes are required to act as fire protection for foamed plastics or to contribute to the required fire resistance of assemblies. [F20-OS2.1]
9.29.5.4.	Support of Insulation
(1)	[F20-OS2.1] [F20-OP2.1] [F20, F22-OP2.4] [F20, F22-OH1.1, OH1.2] Applies where interior finishes support or serve as required environmental separation elements. [F20, F22-OS1.2] Applies where interior finishes are required to act as fire protection for foamed plastics or to contribute to the required fire resistance of assemblies.
9.29.5.5.	Length of Fasteners
(1)	[F20-OP2.1, OP2.4] [F20-OH1.1, OH1.2] Applies where interior finishes support or serve as required environmental separation elements. [F20-OS1.2] Applies where interior finishes are required to act as fire protection for foamed plastics or to contribute to the required fire resistance of assemblies. [F20-OS2.1]
9.29.5.6.	Nails
(1)	[F20-OP2.1, OP2.4] [F20-OH1.1, OH1.2] Applies where interior finishes support or serve as required environmental separation elements. [F20-OS1.2] Applies where interior finishes are required to act as fire protection for foamed plastics or to contribute to the required fire resistance of assemblies. [F20-OS2.1]
9.29.5.7.	Screws
(1)	[F20-OP2.1, OP2.4] [F20-OH1.1, OH1.2] Applies where interior finishes support or serve as required environmental separation elements.

Acceptable Solution	Objectives and Functional Statements
(1) (Cont'd)	[F20-OS1.2] Applies where interior finishes are required to act as fire protection for foamed plastics or to contribute to the required fire resistance of assemblies. [F20-OS2.1]
9.29.5.8.	Spacing of Nails
(1)	[F20-OH1.1, OH1.2] Applies where interior finishes support or serve as required environmental separation elements. [F20-OP1.2] Applies where interior finishes are required to act as fire protection for foamed plastics or to contribute to the required fire resistance of assemblies. [F20-OP2.1] [F20-OP2.3] Applies where interior finishes support or serve as required environmental separation elements. [F20-OS1.2] Applies where interior finishes are required to act as fire protection for foamed plastics or to contribute to the required fire resistance of assemblies. [F20-OS2.1] [F20-OS2.3] Applies where interior finishes support or serve as required environmental separation elements.
(2)	
(3)	[F20-OH1.1, OH1.2] Applies where interior finishes support or serve as required environmental separation elements. [F20-OP2.1] [F20-OP2.3] Applies where interior finishes support or serve as required environmental separation elements. [F20-OS2.1] [F20-OS2.3] Applies where interior finishes support or serve as required environmental separation elements.
(4)	[F20-OP1.2] Applies where interior finishes are required to act as fire protection for foamed plastics or to contribute to the required fire resistance of assemblies. [F20-OP2.1] [F20-OP2.5] [F22-OP2.4, OP2.5] Applies where interior finishes contribute to the required bracing or lateral support for studs. [F20, F22-OP2.3] Applies where interior finishes support or serve as required environmental separation elements. [F20-OP3.1] Applies where interior finishes are installed to contribute to the required fire resistance of exterior walls. [F20-OS1.2] Applies where interior finishes are required to act as fire protection for foamed plastics or to contribute to the required fire resistance of assemblies. [F20-OS2.1] [F20-OS2.5] [F22-OS2.4, OS2.5] Applies where interior finishes contribute to the required bracing or lateral support for studs. [F20, F22-OS2.3] Applies where interior finishes support or serve as required environmental separation elements. [F20, F22-OS3.1, OS3.7] Applies where walls support floors and where interior finishes contribute to the required bracing or lateral support studs or where interior support or serve as required environmental separation elements. [F20, F22-OH1.1, OH1.2, OH1.3] Applies where interior finishes contribute to the required bracing or lateral support for studs or where finishes support or serve as required environmental separation elements. [F20, F22-OH4] Applies where walls support floors and where interior finishes contribute to the required bracing or lateral support studs or where interior support or serve as required environmental separation elements.
(5)	[F20-OP1.2] Applies where interior finishes are required to act as fire protection for foamed plastics or to contribute to the required fire resistance of assemblies. [F20-OP2.1] [F20-OP2.5] [F22-OP2.4, OP2.5] Applies where interior finishes contribute to the required bracing or lateral support for studs. [F20, F22-OP2.3] Applies where interior finishes support or serve as required environmental separation elements. [F20-OP3.1] Applies where interior finishes are installed to contribute to the required fire resistance of exterior walls. [F20-OS1.2] Applies where interior finishes are required to act as fire protection for foamed plastics or to contribute to the required fire resistance of assemblies. [F20-OS2.1] [F20-OS2.5] [F22-OS2.4, OS2.5] Applies where interior finishes contribute to the required bracing or lateral support for studs. [F20, F22-OS2.3] Applies where interior finishes support or serve as required environmental separation elements.

Acceptable Solution	Objectives and Functional Statements
(5) (Cont'd)	<p>[F20-OS3.1, OS3.7] Applies where walls support floors and where interior finishes contribute to the required bracing or lateral support for studs or where interior finishes support or serve as required environmental separation elements.</p> <p>[F20, F22-OH1.1, OH1.2, OH1.3] Applies where interior finishes contribute to the required bracing or lateral support for studs or where interior finishes support or serve as required environmental separation elements.</p> <p>[F20-OH4] Applies where walls support floors and where interior finishes contribute to the required bracing or lateral support for studs or where interior support or serve as required environmental separation elements.</p>
(6)	<p>[F20-OP1.2] Applies where interior finishes are required to act as fire protection for foamed plastics or to contribute to the required fire resistance of assemblies.</p> <p>[F20-OP2.1] [F20-OP2.5] [F22-OP2.4, OP2.5] Applies where interior finishes contribute to the required bracing or lateral support for studs.</p> <p>[F20, F22-OP2.3] Applies where interior finishes support or serve as required environmental separation elements.</p> <p>[F20-OS1.2] Applies where interior finishes are required to act as fire protection for foamed plastics or to contribute to the required fire resistance of assemblies.</p> <p>[F20-OS2.1] [F20-OS2.5] [F22-OS2.4, OS2.5] Applies where interior finishes contribute to the required bracing or lateral support for studs.</p> <p>[F20, F22-OS2.3] Applies where interior finishes support or serve as required environmental separation elements.</p> <p>[F20-OS3.1, OS3.7] Applies where walls support floors and where interior finishes contribute to the required bracing or lateral support for studs or where interior finishes support or serve as required environmental separation elements.</p> <p>[F20, F22-OH1.1, OH1.2, OH1.3] Applies where interior finishes support or serve as required environmental separation elements.</p> <p>[F20-OH4] Applies where walls support floors and where interior finishes contribute to the required bracing or lateral support for studs or where interior support or serve as required environmental separation elements.</p>
(7)	<p>[F20-OP1.2] Applies where interior finishes are required to act as fire protection for foamed plastics or to contribute to the required fire resistance of assemblies.</p> <p>[F20-OP2.1] [F20-OP2.5] [F22-OP2.4, OP2.5] Applies where interior finishes contribute to the required bracing or lateral support for studs.</p> <p>[F20, F22-OP2.3] Applies where interior finishes support or serve as required environmental separation elements.</p> <p>[F20-OP3.1] Applies where interior finishes are installed to contribute to the required fire resistance of exterior walls.</p> <p>[F20-OS1.2] Applies where interior finishes are required to act as fire protection for foamed plastics or to contribute to the required fire resistance of assemblies.</p> <p>[F20-OS2.1] [F20-OS2.5] [F22-OS2.4, OS2.5] Applies where interior finishes contribute to the required bracing or lateral support for studs.</p> <p>[F20, F22-OS2.3] Applies where interior finishes support or serve as required environmental separation elements.</p> <p>[F20-OS3.1, OS3.7] Applies where walls support floors and where interior finishes contribute to the required bracing or lateral support for studs or where interior finishes support or serve as required environmental separation elements.</p> <p>[F20, F22-OH1.1, OH1.2, OH1.3] Applies where interior finishes contribute to the required bracing or lateral support for studs or where interior finishes support or serve as required environmental separation elements.</p> <p>[F20-OH4] Applies where walls support floors and where interior finishes contribute to the required bracing or lateral support for studs or where interior finishes support or serve as required environmental separation elements.</p>
9.29.5.9.	Spacing of Screws
(1)	<p>[F20-OH1.1, OH1.2] Applies where interior finishes support or serve as required environmental separation elements.</p> <p>[F20-OP1.2] Applies where interior finishes are required to act as fire protection for foamed plastics or to contribute to the required fire resistance of assemblies.</p> <p>[F20-OP2.1] [F20-OP2.3] Applies where interior finishes support or serve as required environmental separation elements.</p> <p>[F20-OS1.2] Applies where interior finishes are required to act as fire protection for foamed plastics or to contribute to the required fire resistance of assemblies.</p>

Acceptable Solution	Objectives and Functional Statements
(1) (Cont'd)	[F20-OS2.1] [F20-OS2.3] Applies where interior finishes support or serve as required environmental separation elements.
(2)	
(3)	[F20-OH1.1, OH1.2, OH1.3] Applies where interior finishes support or serve as required environmental separation elements. [F20-OP1.2] Applies where gypsum board is required to provide the fire resistance and the rating of the assembly is determined according to Table 1 in SB-3. [F20-OP2.1] [F20-OP2.3] Applies where interior finishes support or serve as required environmental separation elements. [F20-OP3.1] Applies where interior finishes are installed to contribute to the required fire resistance of exterior walls. [F20-OS1.2] Applies where gypsum board is required to provide the fire resistance and the rating of the assembly is determined according to Table 1 in SB-3. [F20-OS2.1] [F20-OS2.3] Applies where interior finishes support or serve as required environmental separation elements. [F20-OS2.1] [F20-OS2.3] Applies where interior finishes support or serve as required environmental separation elements.
(4)	[F20-OP1.2] Applies where interior finishes are required to act as fire protection for foamed plastics or to contribute to the required fire resistance of assemblies. [F20-OP2.1] [F20-OP2.5] [F22-OP2.4, OP2.5] Applies where interior finishes contribute to the required bracing or lateral support for studs. [F20, F22-OP2.3] Applies where interior finishes support or serve as required environmental separation elements. [F20-OP3.1] Applies where interior finishes are installed to contribute to the required fire resistance of exterior walls. [F20-OS1.2] Applies where interior finishes are required to act as fire protection for foamed plastics or to contribute to the required fire resistance of assemblies. [F20-OS2.1] [F20-OS2.5] [F22-OS2.4, OS2.5] Applies where interior finishes contribute to the required bracing or lateral support for studs. [F20, F22-OS2.3] Applies where interior finishes support or serve as required environmental separation elements. [F20, F22-OS3.1, OS3.7] Applies where the walls support floors and where interior finishes contribute to the required bracing or lateral support for studs or where interior finishes support or serve as required environmental separation elements. [F20, F22-OH1.1, OH1.2, OH1.3] Applies where interior finishes contribute to the required bracing or lateral support for studs or where interior finishes support or serve as required environmental separation elements. [F20, F22-OH4] Applies where the walls support floors and where interior finishes contribute to the required bracing or lateral support for studs or where interior finishes support or serve as required environmental separation elements.
(5)	
(6)	[F20-OP1.2] Applies where interior finishes are required to act as fire protection for foamed plastics or to contribute to the required fire resistance of assemblies. [F20-OP2.1] [F20-OP2.5] [F22-OP2.4, OP2.5] Applies where interior finishes contribute the required bracing or lateral support for studs. [F20, F22-OP2.3] Applies where interior finishes support or serve as required environmental separation elements. [F20-OP3.1] Applies where interior finishes are installed to contribute to the required fire resistance of exterior walls. [F20-OS1.2] Applies where interior finishes are required to act as fire protection for foamed plastics or to contribute to the required fire resistance of assemblies. [F20-OS2.1] [F20-OS2.5] [F22-OS2.4, OS2.5] Applies where interior finishes contribute the required bracing or lateral support for studs. [F20, F22-OS2.3] Applies where interior finishes support or serve as required environmental separation elements. [F20-OS3.1, OS3.7] Applies where the walls support floors and where interior finishes contribute to the required bracing or lateral support for studs or where interior finishes support or serve as required environmental separation elements.

Acceptable Solution	Objectives and Functional Statements
(6) (Cont'd)	<p>[F20, F22-OH1.1, OH1.2, OH1.3] Applies where interior finishes contribute to the required bracing or lateral support for studs or where interior finishes support or serve as required environmental separation elements.</p> <p>[F20-OH4] Applies where walls support floors and where interior finishes contribute to the required bracing or lateral support for studs or where interior finishes support or serve as required environmental separation elements.</p>
(7)	<p>[F20-OP1.2] Applies where interior finishes are required to act as fire protection for foamed plastics or to contribute to the required fire resistance of assemblies.</p> <p>[F20-OP2.1]</p> <p>[F20-OP2.5] [F22-OP2.4, OP2.5] Applies where interior finishes contribute the required bracing or lateral support for studs.</p> <p>[F20, F22-OP2.3] Applies where interior finishes support or serve as required environmental separation elements.</p> <p>[F20-OP3.1] Applies where interior finishes are installed to contribute to the required fire resistance of exterior walls.</p> <p>[F20-OS1.2] Applies where interior finishes are required to act as fire protection for foamed plastics or to contribute to the required fire resistance of assemblies.</p> <p>[F20-OS2.1]</p> <p>[F20-OS2.5] [F22-OS2.4, OS2.5] Applies where interior finishes support or serve as required environmental separation elements.</p> <p>[F20, F22-OS2.3] Applies where interior finishes support or serve as required environmental separation elements.</p> <p>[F20-OS3.1, OS3.7] Applies where the walls support floors and where interior finishes contribute to the required bracing or lateral support for studs or where interior finishes support or serve as required environmental separation elements.</p> <p>[F20, F22-OH1.1, OH1.2, OH1.3] Applies where interior finishes contribute to the required bracing or lateral support for studs or where interior finishes support or serve as required environmental separation elements.</p> <p>[F20-OH4] Applies where walls support floors and where interior finishes contribute to the required bracing or lateral support for studs or where interior finishes support or serve as required environmental separation elements.</p>
9.29.5.10.	Low Temperature Conditions
(1)	[F81-OS1.2] Applies where the finishing of joints is required to maintain required <i>fire-resistance ratings</i> .
9.29.6.1.	Thickness
(1)	<p>[F20-OP2.1] [F20, F22-OP2.4]</p> <p>[F20, F22-OH1.1, OH1.2] Applies where interior finishes support or serve as required environmental separation elements.</p> <p>[F20, F22-OS1.2] Applies where interior finishes are required to act as fire protection for foamed plastics or to contribute to the required fire resistance of assemblies.</p> <p>[F20-OS2.1]</p>
(2)	
(3)	
9.29.6.2.	Grooved Plywood
(1)	<p>[F20, F22-OS1.2] Applies where interior finishes are required to act as fire protection for foamed plastics or to contribute to the required fire resistance of assemblies.</p> <p>[F20-OS2.1]</p> <p>[F20-OP2.1] [F20, F22-OP2.4]</p> <p>[F20, F22-OH1.1, OH1.2] Applies where interior finishes support or serve as required environmental separation elements.</p>
(2)	
9.29.6.3.	Nails and Staples
(1)	<p>[F20-OP2.1] [F20, F22-OP2.4]</p> <p>[F20, F22-OH1.1, OH1.2] Applies where interior finishes support or serve as required environmental separation elements.</p> <p>[F20, F22-OS1.2] Applies where interior finishes are required to act as fire protection for foamed plastics or to contribute to the required fire resistance of assemblies.</p> <p>[F20-OS2.1]</p>
9.29.6.4.	Edge Support
(1)	<p>[F20-OP2.1] [F20, F22-OP2.4]</p> <p>[F20, F22-OH1.1, OH1.2] Applies where interior finishes support or serve as required environmental separation elements.</p>

Acceptable Solution	Objectives and Functional Statements
(1) (Cont'd)	[F20, F22-OS1.2] Applies where interior finishes are required to act as fire protection for foamed plastics or to contribute to the required fire resistance of assemblies. [F20-OS2.1]
9.29.7.1.	Material Standard
(1)	[F20, F80-OP2.1, OP2.3] [F20, F22-OP2.4] [F20, F22, F80-OS1.2] Applies where interior finishes are required to act as fire protection for foamed plastics or to contribute to the required fire resistance of assemblies. [F20, F80-OS2.1, OS2.3] [F20, F22, F80-OH1.1, OH1.2] Applies where interior finishes support or serve as required environmental separation elements.
9.29.7.2.	Thickness
(1)	[F20-OP2.1] [F20, F22-OP2.4] [F20, F22-OH1.1, OH1.2] Applies where interior finishes support or serve as required environmental separation elements. [F20-OS2.1] [F20, F22-OS1.2] Applies where interior finishes are required to act as fire protection for foamed plastics or to contribute to the required fire resistance of assemblies.
9.29.7.3.	Nails
(1)	[F20-OP2.1] [F20, F22-OP2.4] [F20, F22-OH1.1, OH1.2] Applies where interior finishes support or serve as required environmental separation elements. [F20, F22-OS1.2] Applies where interior finishes are required to act as fire protection for foamed plastics or to contribute to the required fire resistance of assemblies. [F20-OS2.1]
9.29.7.4.	Edge Support
(1)	[F20-OP2.1] [F20, F22-OP2.4] [F20, F22-OH1.1, OH1.2] Applies where interior finishes support or serve as required environmental separation elements. [F20, F22-OS1.2] Applies where interior finishes are required to act as fire protection for foamed plastics or to contribute to the required fire resistance of assemblies. [F20-OS2.1]
9.29.8.1.	Material Standard
(1)	[F20F80-OP2.1, OP2.3] [F20, F22-OP2.4] [F20, F22, F80-OS1.2] Applies where interior finishes are required to act as fire protection for foamed plastics or to contribute to the required fire resistance of assemblies. [F20, F80-OS2.1, OS2.3] [F20, F22, F80, F81-OH1.1, OH1.2] Applies where interior finishes support or serve as required environmental separation elements.
9.29.8.2.	Thickness
(1)	[F20-OP2.1] [F20, F22-OP2.4] [F20, F22-OS1.2] Applies where interior finishes are required to act as fire protection for foamed plastics or to contribute to the required fire resistance of assemblies. [F20-OS2.1] [F20, F22-OH1.1, OH1.2] Applies where interior finishes support or serve as required environmental separation elements.
(2)	[F20-OP2.1] [F20, F22-OP2.4] [F20, F22-OS1.2] Applies where interior finishes are required to act as fire protection for foamed plastics or to contribute to the required fire resistance of assemblies. [F20-OS2.1] [F20, F22-OH1.1, OH1.2] Applies where interior finishes support or serve as required environmental separation elements.

Acceptable Solution	Objectives and Functional Statements
9.29.8.3.	Nails
(1)	[F20-OP2.1] [F20, F22-OP2.4] [F20, F22-OS1.2] Applies where interior finishes are required to act as fire protection for foamed plastics or to contribute to the required fire resistance of assemblies. [F20-OS2.1] [F20, F22-OH1.1, OH1.2] Applies where interior finishes support or serve as required environmental separation elements.
(2)	[F20-OP2.1] [F20, F22-OP2.4] [F20, F22-OS1.2] Applies where interior finishes are required to act as fire protection for foamed plastics or to contribute to the required fire resistance of assemblies. [F20-OS2.1] [F20, F22-OH1.1, OH1.2] Applies where interior finishes support or serve as required environmental separation elements.
9.29.8.4.	Edge Support
(1)	[F20-OP2.1] [F20, F22-OP2.4] [F20, F22-OS1.2] Applies where interior finishes are required to act as fire protection for foamed plastics or to contribute to the required fire resistance of assemblies. [F20-OS2.1] [F20, F22-OH1.1, OH1.2] Applies where interior finishes support or serve as required environmental separation elements.
9.29.9.1.	Material Standard
(1)	[F20-OP2.1] [F20, F22-OP2.4] [F20, F22-OS1.2] Applies where interior finishes are required to act as fire protection for foamed plastics or to contribute to the required fire resistance of assemblies. [F20-OS2.1] [F20, F22-OH1.1, OH1.2] Applies where interior finishes support or serve as required environmental separation elements.
(2)	[F20-OP2.1] [F20, F22-OP2.4] [F20, F22-OS1.2] Applies where interior finishes are required to act as fire protection for foamed plastics or to contribute to the required fire resistance of assemblies. [F20-OS2.1] [F20, F22-OH1.1, OH1.2] Applies where interior finishes support or serve as required environmental separation elements.
9.29.9.2.	Minimum Thickness
(1)	[F20-OP2.1] [F20, F22-OP2.4] [F20, F22-OS1.2] Applies where interior finishes are required to act as fire protection for foamed plastics or to contribute to the required fire resistance of assemblies. [F20-OS2.1] [F20, F22-OH1.1, OH1.2] Applies where interior finishes support or serve as required environmental separation elements.
(2)	
(3)	
(4)	[F20-OP2.1] [F20, F22-OP2.4] [F20, F22-OS1.2] Applies where interior finishes are required to act as fire protection for foamed plastics or to contribute to the required fire resistance of assemblies. [F20-OS2.1] [F20, F22-OH1.1, OH1.2] Applies where interior finishes support or serve as required environmental separation elements.
(5)	[F20-OP2.1] [F20-OP2.5] [F22-OP2.4, OP2.5] Applies where interior finishes contribute to the required bracing or lateral support for studs. [F20, F22-OP2.3] Applies where interior finishes support or serve as required environmental separation elements. [F20, F22-OS1.2] Applies where interior finishes are required to act as fire protection for foamed plastics.

Acceptable Solution	Objectives and Functional Statements
(5) (Cont'd)	[F20-OS2.1] [F20-OS2.5] [F22-OS2.4, OS2.5] Applies where interior finishes contribute to the required bracing or lateral support for studs. [F20, F22-OS2.3] Applies where interior finishes support or serve as required environmental separation elements. [F20, F22-OH1.1, OH1.2, OH1.3] Applies where interior finishes support or serve as required environmental separation elements, or where interior finishes contribute to the required bracing of exterior walls.
9.29.9.3.	Nails
(1)	[F20-OP2.1] [F20, F22-OP2.4] [F20, F22-OH1.1, OH1.2] Applies where interior finishes support or serve as required environmental separation elements. [F20, F22-OS1.2] Applies where interior finishes are required to act as fire protection for foamed plastics or to contribute to the required fire resistance of assemblies. [F20-OS2.1]
9.29.9.4.	Edge Support
(1)	[F20-OP2.1] [F20, F22-OP2.4] [F20, F22-OH1.1, OH1.2] Applies where interior finishes support or serve as required environmental separation elements. [F20, F22-OS1.2] Applies where interior finishes are required to act as fire protection for foamed plastics or to contribute to the required fire resistance of assemblies. [F20-OS2.1]
9.29.10.1.	Tile Application
(1)	[F20-OP2.1] [F20-OP2.5] [F22-OP2.4, OP2.5] Applies where the substrate for the tile contribute to the required bracing or lateral support for studs. [F20-OP2.3] Applies where the substrate for the tile serves as a require environmental separation element or where the tile is installed to provide the required waterproof wall finish. [F20-OS1.2] Applies where the substrate is required to act as fire protection for foamed plastics or to contribute to the required fire resistance of assemblies. [F20-OS2.1] [F20-OS2.5] [F22-OS2.4, OS2.5] Applies where the substrate for the tile contributes to the required bracing or lateral support for studs. [F20-OS2.3] Applies where the substrate for the tile serves as a required environmental separation element or where the tile is installed to provide the required waterproof wall finish. [F20, F81-OH1.1, OH1.2] Applies where the substrate serves as a required environmental separation element.
(2)	[F20-OP2.1] [F20-OP2.5] [F22-OP2.4, OP2.5] Applies where the substrate for the tile contribute to the required bracing or lateral support for studs. [F20-OP2.3] Applies where the substrate for the tile serves as a require environmental separation element or where the tile is installed to provide the required waterproof wall finish. [F20-OS1.2] Applies where the substrate is required to act as fire protection for foamed plastics or to contribute to the required fire resistance of assemblies. [F20-OS2.1] [F20-OS2.5] [F22-OS2.4, OS2.5] Applies where the substrate for the tile contributes to the required bracing or lateral support for studs. [F20-OS2.3] Applies where the substrate for the tile serves as a required environmental separation element or where the tile is installed to provide the required waterproof wall finish. [F20, F81-OH1.1, OH1.2] Applies where the substrate serves as a required environmental separation element.
9.29.10.2.	Mortar Base
(1)	[F20-OP2.1] [F20-OP2.5] [F22-OP2.4, OP2.5] Applies where the substrate for the tile contribute to the required bracing or lateral support for studs. [F20-OP2.3] Applies where the substrate for the tile serves as a require environmental separation element or where the tile is installed to provide the required waterproof wall finish. [F20-OS1.2] Applies where the substrate is required to act as fire protection for foamed plastics or to contribute to the required fire resistance of assemblies.

Acceptable Solution	Objectives and Functional Statements
(1) (Cont'd)	[F20-OS2.1] [F20-OS2.5] [F22-OS2.4, OS2.5] Applies where the substrate for the tile contributes to the required bracing or lateral support for studs. [F20-OS2.3] Applies where the substrate for the tile serves as a required environmental separation element or where the tile is installed to provide the required waterproof wall finish. [F20, F81-OH1.1, OH1.2] Applies where the substrate serves as a required environmental separation element.
(2)	[F20-OP2.1] [F20-OP2.5] [F22-OP2.4, OP2.5] Applies where the substrate for the tile contribute to the required bracing or lateral support for studs. [F20-OP2.3] Applies where the substrate for the tile serves as a require environmental separation element or where the tile is installed to provide the required waterproof wall finish. [F20-OS1.2] Applies where the substrate is required to act as fire protection for foamed plastics or to contribute to the required fire resistance of assemblies. [F20-OS2.1] [F20-OS2.5] [F22-OS2.4, OS2.5] Applies where the substrate for the tile contributes to the required bracing or lateral support for studs. [F20-OS2.3] Applies where the substrate for the tile serves as a required environmental separation element or where the tile is installed to provide the required waterproof wall finish. [F20, F81-OH1.1, OH1.2] Applies where the substrate serves as a required environmental separation element.
(3)	[F20-OP2.1] [F20-OP2.5] [F22-OP2.4, OP2.5] Applies where the substrate for the tile contribute to the required bracing or lateral support for studs. [F20-OP2.3] Applies where the substrate for the tile serves as a require environmental separation element or where the tile is installed to provide the required waterproof wall finish. [F20-OS1.2] Applies where the substrate is required to act as fire protection for foamed plastics or to contribute to the required fire resistance of assemblies. [F20-OS2.1] [F20-OS2.5] [F22-OS2.4, OS2.5] Applies where the substrate for the tile contributes to the required bracing or lateral support for studs. [F20-OS2.3] Applies where the substrate for the tile serves as a required environmental separation element or where the tile is installed to provide the required waterproof wall finish. [F20, F81-OH1.1, OH1.2] Applies where the substrate serves as a required environmental separation element.
(4)	[F20-OP2.1] [F20-OP2.5] [F22-OP2.4, OP2.5] Applies where the substrate for the tile contribute to the required bracing or lateral support for studs. [F20-OP2.3] Applies where the substrate for the tile serves as a require environmental separation element or where the tile is installed to provide the required waterproof wall finish. [F20-OS1.2] Applies where the substrate is required to act as fire protection for foamed plastics or to contribute to the required fire resistance of assemblies. [F20-OS2.1] [F20-OS2.5] [F22-OS2.4, OS2.5] Applies where the substrate for the tile contributes to the required bracing or lateral support for studs. [F20-OS2.3] Applies where the substrate for the tile serves as a required environmental separation element or where the tile is installed to provide the required waterproof wall finish. [F20-OH1.1, OH1.2] Applies where the substrate serves as a required environmental separation element.
9.29.10.3.	Adhesives
(1)	[F20-OP2.3, OP2.4] [F20-OH1.1, OH1.2] Applies where the substrate serves as a required environmental separation element. [F20-OS1.2] Applies where the substrate is required to act as fire protection for foamed plastics or to contribute to the required fire resistance of assemblies. [F20-OS2.3]
9.29.10.4.	Moisture Resistant Backing
(1)	[F81-OP2.3, OP2.4] [F20-OS1.2] Applies where the substrate is required to act as fire protection for foamed plastics or to contribute to the required fire resistance of assemblies. [F20-OS2.3] [F81-OH1.1, OH1.2] Applies where the substrate serves as a required environmental separation element.

Acceptable Solution	Objectives and Functional Statements
9.29.10.5.	Joints between Tiles and Bathtub
(1)	[F81-OP2.3, OP2.4] [F81-OH1.1, OH1.2] Applies where the substrate serves as a required environmental separation element. [F81-OS1.2] Applies where the substrate is required to act as fire protection for foamed plastics or to contribute to the required fire resistance of assemblies. [F81-OS2.3]
9.30.1.1.	Required Finish Flooring
(1)	[F30-OS3.1] [F40, F41-OH2.4]
9.30.1.2.	Water Resistance
(1)	[F41, F81-OH1.1] Applies where finished flooring is required to provide water resistance. [F80-OS2.3] Applies where finished flooring is required to provide water resistance.
9.30.1.3.	Sleepers
(1)	[F20, F80-OS3.1] [F80-OH1.1] Applies to portion of Code text: "Wood sleepers support finished flooring over a concrete base supported on the ground ... shall be treated with a wood preservative."
9.30.1.4.	Finish Quality
(1)	
9.30.2.1.	Required Underlay
(1)	[F81-OH1.1] Applies where finished flooring is required to provide water resistance. [F81-OS2.3] Applies where finished flooring is required to provide water resistance. [F81-OS3.1]
(2)	[F81-OH1.1] Applies where finished flooring is required to provide water resistance. [F81-OS2.3] Applies where finished flooring is required to provide water resistance. [F81-OS3.1]
(3)	[F81-OH1.1] Applies where finished flooring is required to provide water resistance. [F81-OS2.3] Applies where finished flooring is required to provide water resistance. [F81-OS3.1]
(4)	[F81-OH1.1] Applies where finished flooring is required to provide water resistance. [F81-OS2.3] Applies where finished flooring is required to provide water resistance. [F81-OS3.1]
9.30.2.2.	Materials and Thickness
(1)	[F81-OH1.1] Applies where finished flooring is required to provide water resistance. [F81-OS2.3] Applies where finished flooring is required to provide water resistance. [F81-OS3.1]
9.30.2.3.	Fastening
(1)	[F81-OH1.1] Applies where finished flooring is required to provide water resistance. [F81-OS2.3] Applies where finished flooring is required to provide water resistance. [F81-OS3.1]
(2)	[F81-OH1.1] Applies where finished flooring is required to provide water resistance. [F81-OS2.3] Applies where finished flooring is required to provide water resistance. [F81-OS3.1]
(3)	[F81-OH1.1] Applies where finished flooring is required to provide water resistance. [F81-OS2.3] Applies where finished flooring is required to provide water resistance. [F81-OS3.1]
9.30.2.4.	Joints Offset
(1)	[F81-OH1.1] Applies where finished flooring is required to provide water resistance. [F81-OS3.1] [F81-OS2.3] Applies where finished flooring is required to provide water resistance.
9.30.2.5.	Surface Defects
(1)	[F81-OH1.1] Applies where finished flooring is required to provide water resistance. [F81-OS2.3] Applies where finished flooring is required to provide water resistance.

Acceptable Solution	Objectives and Functional Statements
(1) (Cont'd)	[F81-OS3.1]
9.30.3.1. Thickness	
(1)	[F20-OS2.1] [F30-OS3.1]
9.30.3.2. Strip Direction and End Joints	
(1)	[F30-OS3.1]
(2)	[F20-OS2.1]
(3)	[F20-OS2.1]
9.30.3.3. Nailing	
(1)	[F30-OS3.1]
(2)	[F30-OS3.1]
9.30.3.4. Staples	
(1)	[F30-OS3.1]
(2)	[F30-OS3.1]
9.30.4.1. Adhesive	
(1)	[F81-OS3.1]
9.30.5.1. Materials	
(1)	[F41, F80-OH1.1] [F80-OS3.1]
(2)	[F41-OH1.1] [F81, F80-OS3.1]
9.30.6.1. Substrate	
(1)	[F81-OH1.1] Applies where finished flooring is required to provide water resistance. [F81-OS2.3] Applies where finished flooring is required to provide water resistance. [F81-OS3.1]
(2)	[F81-OH1.1] Applies where finished flooring is required to provide water resistance. [F81-OS2.3] Applies where finished flooring is required to provide water resistance. [F81-OS3.1]
9.31.1.1. Application	
(1)	
(2)	
(3)	
9.31.2.1. General	
(1)	
9.31.2.2. Corrosion Protection	
(1)	[F80-OH2.1] [F80-OS2.3]
9.31.2.3. Grab Bars	
(1)	[F20-OS3.1]
9.31.3.1. Required Water Supply	
(1)	[F70, F71-OH2.2, OH2.3]
9.31.3.2. Required Connections	
(1)	[F70, F71-OH2.3]
(2)	[F70, F71-OH2.3]
9.31.4.1. Required Fixtures	
(1)	[F70, F71, F72-OH2.1, OH2.3]
9.31.4.2. Laundry Fixtures	
(1)	
9.31.4.3. Hot Water Supply	
(1)	[F40-OH2.1, OH2.4] [F71-OH2.3] applies to "a hot water supply shall be provided"
(2)	

Acceptable Solution	Objectives and Functional Statements
9.31.4.4.	Floor Drains
(1)	[F40, F41, F62-OH1.2, OH1.3] [F62-OH1.1]
9.31.6.1.	Hot Water Temperature
(1)	[F31-OS2.3] Applies to hot water supply equipment. [F41-OH2.2] Applies to hot water supply equipment.
(2)	[F41-OH2.2]
9.31.6.2.	Equipment and Installation
(1)	
(2)	
(3)	[F01-OS1.1] [F23-OS3.4]
9.31.6.3.	Corrosion-Resistant Coating
(1)	[F80, F81-OH2.3]
9.31.6.4.	Fuel-Burning Heaters
(1)	[F01-OS1.1] [F44-OH1.1]
9.31.6.5.	Heating Coils
(1)	[F31-OS2.3] [F71-OH2.3]
9.32.1.1.	Application
(1)	
(2)	
(3)	
(4)	
(5)	
9.32.1.2.	Mechanical Ventilation for Dwelling Units
(1)	[F40, F50, F52-OH1.1] [F51, F52-OH1.2]
9.32.1.3.	Ventilation of Rooms and Spaces
(1)	[F40, F50, F52-OH1.1] [F51, F52-OH1.2]
(2)	
(3)	[F40, F50, F52-OH1.1] [F51, F52-OH1.2]
9.32.1.4.	Venting of Laundry-Drying Equipment
(1)	[F40, F44, F50, F52-OH1.2] [F01-OS1.1] [F01-OP1.1]
(2)	[F40, F80-OH1.1] [F81-OS1.1] [F63, F80-OS2.3] [F81-OP1.1]
(3)	[F40, F44, F50, F52-OH1.2] [F01-OS1.1] [F01-OP1.1]
9.32.2.1.	Natural Ventilation Area
(1)	[F40, F50, F52-OH1.1] [F51, F52-OH1.2]
(2)	
9.32.2.2.	Protection from Weather and Insects
(1)	[F42, F61 -OH1.1] [F42, F61-OS2.3] [F42-OH2.5]
(2)	[F42, F80-OH1.1, OH1.2] [F80-OH2.5]
9.32.3.1.	General
(1), (2)	

F11.1

Acceptable Solution	Objectives and Functional Statements
9.32.3.2.	Required Mechanical Ventilation
(1)	
9.32.3.3.	Total Ventilation Capacity
(1)	[F40, F50, F52-OH1.1] [F51, F52-OH1.2]
9.32.3.4.	Principal Exhaust
(1)	[F40, F50, F52-OH1.1] [F51, F52-OH1.2]
(2)	[F81-OH1.1]
(3)	[F81-OH1.1]
(4)	[F81-OH1.1]
(5)	
(6)	[F131-OR2]
(7)	[F40, F50, F52-OH1.1]
(8)	[F40-OH1.1]
(9)	[F40, F50, F52, F53-OH1.1] [F53-OS3.4]
(10)	
9.32.3.5.	Supplemental Exhaust
(1)	[F40, F50, F52, F53-OH1.1] [F53-OS3.4]
(2)	[F40, F50, F52-OH1.1] [F52-OH1.2]
(3)	[F40-OH1.1]
(4)	[F40, F50, F52, F53-OH1.1] [F53-OS3.4]
(5)	[F40-OH1.1]
(6)	[F40-OH1.1]
(7)	[F40-OH1.1]
(8)	[F40-OH1.1]
(9)	
9.32.3.6.	Ventilation Systems Coupled with Forced Air Heating Systems
(1)	
(2)	
(3)	[F53, F81-OH1.1] [F43, F50, F53, F81-OS3.4]
(4)	[F53, F63-OH1.1] [F53, F63-OS2.3] [F50, F53-OS3.4]
(5)	[F81-OH1.1]
9.32.3.7.	Ventilation Systems Not Coupled with Forced Air Heating Systems
(1)	
(2)	[F40, F50, F52-OH1.1]
(3)	[F53, F81-OH1.1] [F43, F50, F53, F81-OS3.4]
(4)	[F40, F50, F52-OH1.1]
(5)	[F40, F50, F52, F53-OH1.1] [F53-OS3.4]
(6)	
(7)	[F40, F50, F52, F53-OH1.1]
(8)	
(9)	[F40, F50, F52, F53-OH1.1] [F53-OS3.4]
(10)	[F40, F50, F52-OH1.1]

Acceptable Solution	Objectives and Functional Statements
9.32.3.8.	Protection Against Depressurization
(1)	
(2)	[F53, F81-OH1.1] [F43, F50, F53, F81-OS3.4]
(3)	
9.32.3.9.	Fan Ratings
(1)	[F40, F50, F52, F53-OH1.1] [F51, F52-OH1.2] [F53, F63-OS2.3]
(2)	[F81-OH1.1, OH1.2]
(3)	[F53-OH1.1, OH1.2] [F53-OS3.4]
(4)	[F81-OH1.1, OH1.2]
(5)	[F40, F50, F52, F53-OH1.1] [F51, F52-OH1.2] [F53, F63-OS2.3]
(6)	[F40, F50, F52, F53-OH1.1] [F51, F52-OH1.2] [F81-OS3.4]
9.32.3.10.	Ducts
(1)	[F81-OH1.1]
(2)	[F40, F52, F63-OH1.1] [F52, F63-OS2.3]
(3)	[F63-OH1.1] [F63, F80-OS2.3] [F131-OR2]
(4)	[F63-OH1.1] [F131-OR2] [F63, F80-OS2.3]
(5)	[F82-OH1.1] [F82-OP1.1] [F82-OS1.1]
(6)	[F02, F03, F80-OS1.1]
(7)	[F02, F03, F82-OS1.1]
(8)	[F40, F41-OH1.1] [F40, F63-OS2.3]
(9)	[F40, F41-OH1.1] [F40, F63-OS2.3]
(10)	[F40, F50, F52, F53-OH1.1] [F53-OS3.4]
9.32.3.11.	Heat Recovery Ventilators
(1)	
(2)	[F131-OR2]
(3)	[F51, F81-OH1.2]
(4)	[F40, F50, F52-OH1.1]
(5)	[F40, F50, F52-OH1.1]
(6)	[F81-OH1.1]
(7)	[F53-OH1.1, OH1.2] [F53, F63-OS2.3] [F43, F53-OS3.4]
(8)	[F62-OH1.1]
(9)	[F81-OH1.1]
(10)	[F53-OH1.1, OH1.2] [F53, F63-OS2.3] [F43, F53-OS3.4]

F3

Acceptable Solution	Objectives and Functional Statements
9.32.3.12.	Outdoor Intake and Exhaust Openings
(1)	[F40, F50, F52-OH1.1] [F40, F44, F50-OS3.4]
(2)	[F40, F50, F52-OH1.1] [F40, F44, F50-OS3.4]
(3)	[F40, F50, F52, F53-OH1.1] [F43, F53-OS3.4]
(4)	[F40, F50, F52-OH1.1] [F40, F50, F44-OS3.4]
(5)	[F40, F50, F52-OH1.1] [F40, F44, F50, F53-OS3.4]
(6)	[F40, F53-OH1.1]
(7)	[F61-OH1.1] [F61-OS2.3]
(8)	[F42-OH1.1] [F42-OH2.5] [F01, F42-OS1.1]
(9)	[F42, F63-OH1.1] [F01, F42-OS1.1]
(10)	[F42-OH1.1]
(11)	[F53, F82-OH1.1] [F43, F53, F82-OS3.4]
(12)	[F53, F81-OH1.1] [F43, F53-OS3.4]
(13)	[F42, F80-OH2.5] [F01, F42, F80-OS1.1]
(14)	[F53, F81-OH1.1] [F43, F53-OS3.4]
9.32.3.13.	Installation
(1)	[F81-OH1.1] [F81-OS3.4]
(2)	[F40, F43, F50, F53-OH1.1] [F43, F53, F82-OS3.4]
(3)	[F82-OH1.1]
(4)	[F63, F81-OH1.1]
9.33.1.1.	Design and Installation Requirements
(1) to (3)	
9.33.1.2.	Solid Fuel-Burning Appliances
(1)	[F43-OP1.1] [F43-OS1.1] [F43-OS3.4]
9.33.1.3.	Structural Movement
(1)	[F20-OS1.1] [F20-OS3.3, OS3.4]
9.33.2.1.	Residential Heating Systems
(1)	[F51, F52-OH1.2] [F63-OH1.1] [F63-OS2.3]
(2)	[F110-OE]
9.33.2.2.	Equipment Sizing
(1)	[F131, F132, F133, F150-OR1.2]
(2)	[F131, F132, F133, F150-OR1.2]
(3)	[F131, F132, F133, F150-OR1.2]

e2

r3

Acceptable Solution	Objectives and Functional Statements
9.33.3.1.	Indoor Design Temperatures
(1)	(a), (b), (c) [F51-OH1.2]
9.33.3.2.	Outdoor Design Temperatures
(1)	
9.33.4.1.	Application
(1)	
9.33.4.2.	Location of Carbon Monoxide Alarms
(1)	[F44-OS3.4]
(2)	[F44-OS3.4]
(3)	[F44-OS3.4]
(4)	[F44-OS3.4]
(5)	[F44-OS3.4]
9.33.4.3.	Installation and Conformance to Standards
(1)	[F44-OS3.4] (a), (d) [F81-OS3.4]
(2)	
9.34.1.1.	Reserved
9.34.1.2.	Required Facilities
(1)	
9.34.1.3.	Location of Equipment in Public Areas
(1)	[F10-OS3.1] [F32, F81-OS3.3]
9.34.1.4.	Recessed Lighting Fixtures
(1)	[F01-OS1.1]
9.34.1.5.	Wiring and Cables
(1)	[F02-OS1.2] [F02-OP1.2]
(2)	
9.34.2.1.	Lighting of Entrances
(1)	[F30-OS3.1] [F34-OS4.2]
(2)	
r6 e4.1 e5	9.34.2.2. Lighting Outlets in Houses and Dwelling Units
	(1), (2) [F30-OS3.1]
	9.34.2.3. Stairways
	(1), (2) [F30-OS3.1]
	(3)
	9.34.2.4. Basements
	(1) [F30-OS3.1]
	(2) [F30-OS3.1]
	9.34.2.5. Storage Rooms
	(1) [F30-OS3.1]
e4.1	9.34.2.6. Garages and Carports
	(1) to (3) [F30-OS3.1]
	(4)
e4.1	9.34.2.7. Public and Service Areas
	(1) to (3) [F30-OS3.1]
	9.34.3.1. Emergency Lighting
	(1)
r11	9.34.4.1. Revoked
	9.35.1.1. Application
	(1)
	9.35.1.2. Construction Requirements
	(1)

11.1
6.1

Acceptable Solution	Objectives and Functional Statements
9.35.2.1.	Carport Considered to be Garage
(1)	
9.35.2.2.	Garage Floor
(1)	[F40-OS1.1]
9.35.3.1.	Foundation Required
(1)	
(2)	
9.35.3.2.	Protection from Damage due to Soil Movement
(1), (2)	[F21-OH1.1, OH1.2, OH1.3]
	[F21-OH4] Applies to floors and elements that support floors.
	[F21-OP2.3, OP2.4]
	[F21-OS2.3]
	[F21-OS3.1] Applies to floors and elements that support floors.
(3)	
9.35.3.3.	Small Garages
(1)	
9.35.3.4.	Column Piers
(1)	[F80-OP2.3]
	[F80-OS2.3]
(2)	[F20-OP2.1, OP2.2]
	[F20-OS2.1, OS2.2]
9.35.4.1.	Interior Finish
(1)	
9.35.4.2.	Columns
(1)	[F20-OP2.1]
	[F20-OS2.1]
9.35.4.3.	Anchorage
(1)	[F22-OP2.4, OP2.5]
	[F22-OS2.4, OS2.5]
9.36.1.1.	Application
(1)	
(2)	
9.36.2.1.	Exclusions
(1)	
(2)	[F42-OH2.5]
	[F20-OP2.1]
	[F20-OS2.1] [F30-OS3.1]
(3)	
(4)	
(5)	
9.36.2.2.	Foundations
(1)	
(2)	[F20-OP2.1]
	[F20-OS2.1]
(3)	
9.36.2.3.	Waterproofing and Dampproofing
(1)	
9.36.2.4.	Smoke Alarms
(1)	
9.36.3.1.	Buildings for Seasonal Tourist Accommodation or for Rent
(1)	

Acceptable Solution	Objectives and Functional Statements
9.37.1.1.	Material Requirements
(1)	[F20-OP2.1]
	[F20-OS2.1]
9.37.1.2.	Requirement for Wood Preservative
(1)	[F80-OH4]
	[F80-OP2.1, OP2.3]
	[F80-OS2.3, OS3.1]
9.37.1.3.	Exterior Joints
(1)	[F61-OH1.3]
	[F42-OH2.5]
	[F61-OP2.3]
9.37.2.1.	Logs
(1)	
9.37.2.2.	Attachment of Logs
(1)	[F61-OH1.3]
	[F42-OH2.5]
	[F61-OP2.3]
9.37.2.3.	Joining Logs
(1)	[F22-OP2.5]
	[F22-OS2.5]
9.37.2.4.	Vertical Logs
(1)	[F22-OP2.5]
	[F22-OS2.5]
9.37.2.5.	Plates
(1)	[F20-OP2.1]
	[F20-OS2.1]
9.37.3.1.	Support Over Openings
(1)	[F22-OP2.5]
	[F22-OS2.5]
9.37.3.2.	Clearance
(1)	[F21-OP2.4]
	[F21-OS2.4]
9.38.1.1.	Application
(1)	
9.38.2.1.	General
(1)	
9.38.3.1.	Other Building Components
(1)	
9.38.3.2.	Spatial Separation
(1)	
9.38.3.3.	Foundations and Anchorage
(1)	[F20, F22-OS2.1, OS2.2, OS2.5]
	[F20, F22-OP2.1, OP2.2, OP2.4, OP2.5]
9.38.3.4.	Proximity to Above Ground Electrical Conductors
(1)	
9.39.1.1.	Application
(1)	
(2)	
(3)	
9.39.1.2.	Concrete
(1)	

Acceptable Solution	Objectives and Functional Statements
9.39.1.3.	Reinforcing Steel
(1)	[F20, F21-OH4] [F20-OP2.1, OP2.4] [F21-OP2.4] [F20-OS2.1]
9.39.1.4.	Slab Construction
(1)	[F20, F21, F55, F61, F80-OH1.1, OH1.2] [F20, F21, F61, F80-OH1.3] Applies where concrete supports or is used in an environmental separator. [F20, F21, F80-OH4] [F20-OP2.1, OP2.4] [F21-OP2.3, OP2.4] [F80-OP2.3] [F20-OP2.3] Applies to elements that support or are part of an environmental separator. [F20-OS2.1] [F21, F80-OS2.3] [F20-OS2.3] Applies to elements that support or are part of an environmental separator. [F20, F21, F80-OS3.1]
(2)	[F20, F21, F55, F61, F80-OH1.1, OH1.2] [F20, F21, F61, F80-OH1.3] Applies where concrete supports or is used in an environmental separator. [F20, F21, F80-OH4] [F20-OP2.1, OP2.4] [F21-OP2.3, OP2.4] [F80-OP2.3] [F20-OP2.3] Applies to elements that support or are part of an environmental separator. [F20-OS2.1] [F21, F80-OS2.3] [F20-OS2.3] Applies to elements that support or are part of an environmental separator. [F20, F21, F80-OS3.1]
(3)	[F20, F21-OH4] [F20-OP2.1, OP2.4] [F21-OP2.4] [F20-OS2.1]
(4)	[F22-OP2.5] [F22-OS2.5]
(5)	[F61, F62-OH1.1, OH1.2, OH1.3] [F61, F62, F80-OP2.3] [F61, F62, F80-OS2.3] [F30-OS3.1]
9.40.1.1.	Application
(1)	
(2)	
(3)	
9.40.2.1.	Change of Use and Compensating Construction
(1)	9.5 Applies to the design of areas and spaces in buildings. [F74-OA2] [F70, F71-OH2.3] [F101-OH6] [F30-OS3.1] [F10-OS3.7]

Acceptable Solution	Objectives and Functional Statements
(1) (Cont'd)	<p>9.7 Applies to windows and skylights in Part 9 buildings. [F55, F61, F62, F63, F80, F81, F82-OH1.1] [F51, F53, F54, F55, F61, F62, F63, F80, F82-OH1.2] [F61, F62, F63-OH1.3] [F102-OH7] [F42-OP2.3] [F03, F20-OS1.2] [F10-OS1.5] [F20-OS2.1] [F20, F21, F42, F61, F63-OS2.3] [F30-OS3.1] [F10, F30-OS3.7] [F34-OS4.1] [F131-OR2]</p> <p>9.10.17. Applies to flame-spread limits in Part 9 buildings. [F01, F02-OS1.2] [F01, F02, F05-OS1.5]</p> <p>9.31. Applies to plumbing facilities serving Part 9 dwelling units. [F44, F62-OH1.1] [F40, F41, F62-OH1.2, OH1.3] [F70, F71, F72, F80-OH2.1] [F41-OH2.2] [F70, F71, F72, F80, F81-OH2.3] [F01-OS1.1] [F31, F80-OS2.3] [F20-OS3.1] [F23-OS3.4]</p> <p>9.32. Applies to ventilation in Part 9 residential occupancies. [F40, F42, F50, F52, F53, F61, F80, F81, F82-OH1.1] [F42, F51, F52, F80, F81-OH1.2] [F42, F80-OH2.5] [F82-OP1.1] [F131-OR2] [F02, F03, F80, F82-OS1.1] [F42, F53, F61, F63-OS2.3] [F40, F43, F44, F50, F53, F81-OS3.4]</p> <p>9.34.1. [F01-OS1.1] [F10-OS3.1] [F32, F81-OS3.3] Applies to electrical facilities in Part 9 buildings.</p> <p>9.34.2. [F30-OS3.1] Applies to lighting outlets for Part 9 buildings. [F34-OS4.2] Applies to lighting outlets for Part 9 buildings.</p> <p>9.34.3. [F30-OS3.1] [F10-OS3.7] Applies to emergency lighting for Part 9 buildings.</p>
(2)	
9.40.2.2.	Performance Level Evaluation and Compensating Construction
(1)	[F140-OC]
(2)	
(3)	
(4)	

Table 10
Objectives and Functional Statements Attributed to the Acceptable Solutions in Part 10 of Division B

Acceptable Solution	Objectives and Functional Statements
10.1.1.1.	Scope
(1)	
10.1.1.2.	Change in Major Occupancy
(1)	
10.2.1.1.	Classification of Major Occupancy
(1)	
10.2.1.2.	Classification According to Construction and Occupancy
(1)	
10.2.1.3.	Building Size and Construction
(1)	
10.3.1.1.	General
(1)	3.2.6.
	<p>Applies to additional requirements for high <i>buildings</i>. [F03, F06, F12, F13, F82-OP1.2] [F03-OP3.1] [F02, F03, F06, F12, F13, F82-OS1.2] [F02, F03, F05, F06, F10, F11, F12, F82-OS1.5] [F30-OS3.1] [F11, F12-OS3.7]</p>
	3.7.
	<p>Applies to health requirements for <i>buildings</i>. [F74-OA2] [F50-OH1.1] [F40, F72-OH2.1] [F70-OH2.2] [F71-OH2.3] [F40, F41-OH2.4] [F101-OH6] [F102-OH7] [F01-OP1.1] [F01-OS1.1] [F20, F30-OS3.1] [F32-OS3.3] [F43, F44-OS3.4]</p>
	3.11.
	<p>Applies to public pools. [F74-OA2] [F50-OH1.1] [F72-OH2.1] [F46, F70-OH2.2] [F40, F41, F45, F71, F122-OH2.3] [F40, F41-OH2.4] [F101-OH6] [F01-OS1.1] [F04-OS1.3] [F03-OS2.1] [F12, F30, F34, F36, F120, F121, F123, F124-OS3.1] [F31-OS3.2] [F32, F34-OS3.3] [F34, F43, F44, F81, F122-OS3.4] [F10, F11, F12, F34, F123-OS3.7]</p>
	3.12.
	<p>Applies to public spas. [F74-OA2] [F46-OH2.2] [F40, F41, F70, F71, F72, F81, F122-OH2.3] [F40, F41-OH2.4] [F11, F12, F13, F30, F34, F36, F81, F120, F121, F123, F124-OS3.1] [F43, F81, F122-OS3.4] [F10, F34, F123-OS3.7]</p>
	9.5.
	<p>Applies to the design of areas and spaces in <i>buildings</i>. [F74-OA2] [F70, F71-OH2.3] [F101-OH6] [F30-OS3.1] [F10-OS3.7]</p>

Acceptable Solution	Objectives and Functional Statements
(1) (Cont'd)	<p>9.7. Applies to windows and skylights in Part 9 <i>buildings</i>. [F55, F61, F62, F63, F80, F81, F82-OH1.1] [F51, F53, F54, F55, F61, F62, F63, F80, F82-OH1.2] [F61, F62, F63-OH1.3] [F102-OH7] [F42-OP2.3] [F03, F20-OS1.2] [F10-OS1.5] [F20-OS2.1] [F20, F21, F42, F61, F63-OS2.3] [F30-OS3.1] [F10, F30-OS3.7] [F34-OS4.1] [F131-OR2]</p> <p>9.10.17. Applies to flame spread limits in Part 9 <i>buildings</i>. [F01, F02-OS1.2] [F01, F02, F05-OS1.5]</p> <p>9.31. Applies to plumbing facilities serving Part 9 dwelling units. [F44, F62-OH1.1] [F40, F41, F62-OH1.2, OH1.3] [F70, F71, F72, F80-OH2.1] [F41-OH2.2] [F70, F71, F72, F80, F81-OH2.3] [F01-OS1.1] [F31, F80-OS2.3] [F20-OS3.1] [F23-OS3.4]</p> <p>9.32. Applies to ventilation in Part 9 residential occupancies. [F40, F42, F50, F52, F53, F61, F80, F81, F82-OH1.1] [F42, F51, F52, F80, F81-OH1.2] [F42, F80-OH2.5] [F82-OP1.1] [F131-OR2] [F02, F03, F80, F82-OS1.1] [F42, F53, F61, F63-OS2.3] [F40, F43, F44, F50, F53, F81-OS3.4]</p> <p>9.34.1. [F01-OS1.1] [F10-OS3.1] [F32, F81-OS3.3] Applies to electrical facilities in Part 9 <i>buildings</i>.</p> <p>9.34.2. [F30-OS3.1] Applies to lighting outlets for Part 9 <i>buildings</i>. [F34-OS4.2] Applies to lighting outlets for Part 9 <i>buildings</i>.</p> <p>9.34.3. [F30-OS3.1] [F10-OS3.7] Applies to emergency lighting for Part 9 <i>buildings</i>.</p>
10.3.2.1.	General
(1)	[F140-OC]
(2)	
10.3.2.2.	Reduction in Performance Level
(1)	
(2)	
(3)	
(4)	
(5)	
(6)	
(7)	
(8)	
(9)	
(10)	
(11)	
10.4.1.1.	Substitution
(1)	
(2)	

Table 11
Objectives and Functional Statements Attributed to the Acceptable Solutions in Part 11 of Division B

Acceptable Solution	Objectives and Functional Statements
11.1.1.1.	Scope
(1)	
11.1.1.2.	Definitions
(1)	
11.1.2.1.	Extension, Material Alteration or Repair
(1)	
11.2.1.1.	Construction Index and Hazard Index
(1)	
(2)	
(3)	
11.2.1.2.	Multiple Occupancies
(1)	
11.2.1.3.	Prohibition of Occupancy Combinations
(1)	[F41-OH2.1]
	[F02, F03-OS1.2] [F10-OS1.5]
11.3.1.1.	Material Alteration or Repair of a Building System
(1)	[F140-OC]
11.3.1.2.	New Building Systems and Extension of Existing Building Systems
(1)	
r3 11.3.2.1.	Portion of Extended Buildings
(1)	
11.3.3.1.	Basic Renovation
(1)	
(2)	
r5 11.3.3.2.	Extensive Renovation
(1)	
(2)	
(3)	
(4)	[F02, F04-OP1.2, OP1.3]
(5)	[F02, F04-OS1.2, OS1.3]
(6)	
11.3.4.1.	Extension, Material Alteration or Repair
(1)	
11.3.5.1.	Existing Septic Tanks
(1)	
r3 11.3.5.2.	Vertical Separations and Existing Sewage Systems
(1)	[F110-OE]
	[F113- OH2.1,OH5]
11.4.1.1.	Performance Level
(1)	[F140-OC]
(2)	
(3)	
11.4.2.1.	Structural
(1)	
11.4.2.2.	Increase in Occupant Load
e2 (1) to (3)	
11.4.2.3.	Change of Major Occupancy
e3 (1) to (6)	

Acceptable Solution	Objectives and Functional Statements
11.4.2.4.	Plumbing
(1)	
11.4.2.5.	Sewage Systems
(1)	
(2)	
(3)	
(4)	
rs 11.4.2.6.	Extension of Buildings of Combustible Construction
(1)	
11.4.3.1.	General
(1)	
(2)	
(3)	
11.4.3.2.	Structural
(1)	[F110-OE] Applies to manure storage tanks. [F21, F22, F61, F80, F81-OH4] [F04-OP1.2] [F20-OP2.1, OP2.2, OP2.3, OP2.4, OP2.6] [F21-OP2.1, OP2.2, OP2.4, OP2.5, OP2.6] [F22-OP2.1, OP2.3, OP2.4, OP2.5] [F81-OP2.1, OP2.4] [F82-OP2.3] [F61-OP2.3, OP2.4] [F80-OP2.3, OP2.4, OP2.6] [F04-OP3.1] [F21-OP4.1, OP4.4] [F20-OP4.3] [F04-OS1.2] [F20-OS2.1, OS2.2, OS2.3, OS2.4] [F21-OS2.1, OS2.2, OS2.3, OS2.5, OS2.6] [F61-OS2.3] [F80-OS2.3] [F81-OS2.3] [F82-OS2.3] [F30-OS3.1] [F43-OS3.4] Applies to manure storage tanks.
11.4.3.3.	Increase in Occupant Load
(1)	As applied to fire alarm systems in Subsection 3.2.4.: [F12, F13, F81, F82-OP1.2] [F02, F03, F11, F12, F13, F81, F82-OS1.2] [F11, F13-OS1.4] [F10, F11, F12, F13, F81, F82-OS1.5] [F11, F12-OS3.7] Applies to voice communication systems. As applied to smoke control measures, and at least one elevator to permit transport of fire fighters to all floors in hotels whose floor level is more than 18 m high measured between <i>grade</i> and floor level of the top <i>storey</i> in Subsection 3.2.6.: [F02, F03, F06, F12, F13, F82-OP1.2] [F03-OP3.1] [F02, F03, F06, F12, F13, F82-OS1.2] [F02, F03, F05, F06, F10, F12-OS1.5] [F30-OS3.1] As applied to lighting of <i>exits</i> , lighting of access to <i>exits</i> and emergency lighting in Subsection 3.2.7.: [F40-OH2.4] [F12-OH5] Applies to the requirement for a suitably identified shut-off valve outside the <i>building</i> . [F01-OP1.1] [F01, F02, F03, F06, F12, F81-OP1.2] [F02-OP3.1] [F12-OS1.1] Applies to the requirement for a suitably identified shut-off valve outside the <i>building</i> . [F02, F03, F06, F10, F11, F12, F81-OS1.2] [F02, F03, F06, F10, F11, F12, F81-OS1.5] [F02, F06, F30, F81-OS3.1] [F36-OS3.6] [F10, F11, F12, F81-OS3.7]

Acceptable Solution	Objectives and Functional Statements
(1) (Cont'd)	<p>As applied to access to <i>exit</i> widths based on <i>occupant load</i> in Article 3.3.1.16.: [F10-OS3.7]</p> <p>As applied to door release hardware in Article 3.3.1.12.: [F73-OA1] [F30-OS3.1] [F10, F12-OS3.7]</p> <p>As applied to travel distance in Article 3.4.2.4.: [F10-OS3.7]</p> <p>As applied to number of <i>exits</i> in Articles 3.4.2.3. and 3.4.2.5.: [F05, F10-OS1.5] [F10-OS3.7]</p> <p>As applied to exit widths based on <i>occupant load</i> in Article 3.4.3.2.: [F12-OP1.2] [F12-OS1.2] [F30-OS3.1] [F10, F12-OS3.7]</p> <p>As applied to <i>exit</i> signs in Articles 3.4.5.1. and 3.4.5.2.: [F10, F81-OS3.7]</p> <p>As applied to door release hardware in Article 3.4.6.15.: [F73-OA1] [F02-OS1.2] [F10, F81-OS1.5] [F10, F81-OS3.7]</p> <p>As applied to access to <i>exit</i> widths based on <i>occupant load</i> in Subsection 9.9.3.: [F30-OS3.1] [F10-OS3.7]</p> <p>As applied to <i>exit</i> widths based on <i>occupant load</i> in Subsection 9.9.3.: [F30-OS3.1] [F10-OS3.7]</p> <p>As applied to travel distance in Article 9.9.9.1.: [F10-OS3.7]</p> <p>As applied to number of <i>exits</i> in Articles 9.9.8.2. and 9.9.9.2.: [F10-OS3.7]</p> <p>As applied to <i>exit</i> signs in Subsection 9.9.10.: [F73-OA1] [F10-OS1.5] [F10-OS3.7]</p> <p>As applied to lighting of <i>exits</i>, lighting of <i>access to exits</i> and emergency lighting in Article 9.9.11.: [F30-OS3.1] [F10-OS3.7]</p> <p>As applied to fire alarm systems in Subsection 9.10.18.: [F02-OS1.2] Applies to a <i>sprinklered building</i>. [F03, F11-OS1.2] [F11-OS1.5]</p> <p>As applied to smoke alarms in Subsection 9.10.19.: [F11, F81-OS1.4] [F11, F81, F82-OS1.5]</p>
(2)	
(3)	<p>As applied to required ventilation for <i>buildings</i> in Sentence 6.2.2.1.(2): [F50-OH1.1]</p> <p>As applied to plumbing facilities for <i>buildings</i> in Subsection 3.7.4.: [F74-OA2] [F50-OH1.1] [F72-OH2.1] [F70-OH2.2] [F71-OH2.3] [F40-OH2.4] [F101-OH6] [F20, F30-OS3.1]</p> <p>As applied to plumbing facilities serving Part 9 <i>dwelling units</i> in Article 9.31.1.1.: [F44, F62-OH1.1] [F40, F41, F62-OH1.2, OH1.3] [F70, F71, F72, F80-OH2.1] [F41-OH2.2] [F70, F71, F72, F80, F81-OH2.3] [F01-OS1.1] [F31, F80-OS2.3] [F20-OS3.1] [F23-OS3.4]</p>

Acceptable Solution	Objectives and Functional Statements
11.4.3.4.	Change in Major Occupancy
(1)	<p>[F02, F03, F04-OP1.2, OP1.3] Applies to increase in <i>construction index</i>. [F02, F04-OP1.2, OP1.3] Applies where the <i>building</i> is required to be <i>sprinklered</i>. [F02, F03, F04-OS1.2, OS1.3] Applies to increase in <i>construction index</i>. [F02, F04-OS1.2, OS1.3] Applies where the <i>building</i> is required to be <i>sprinklered</i>.</p> <p>Applies where an Early Warning system is provided for a Part 3 <i>building</i>, in accordance with Subsection 3.2.4.: [F12, F13, F81, F82-OP1.2] [F02, F03, F11, F12, F13, F81, F82-OS1.2] [F11, F13-OS1.4] [F10, F11, F12, F13, F81, F82-OS1.5] [F11, F12-OS3.7] Applies to voice communication systems.</p> <p>Applies where an Early Warning system is provided for a Part 9 <i>building</i>, in accordance with Subsection 9.10.18.: [F02-OS1.2] Applies to a <i>sprinklered building</i>. [F03, F11-OS1.2] [F11-OS1.5]</p> <p>Applies where an Early Warning system is provided for a Part 9 <i>building</i>, in accordance with Subsection 9.10.19.: [F11, F81-OS1.4] [F11, F81, F82-OS1.5]</p>
(2)	<p>As applied to additional requirements for high <i>buildings</i> in Subsection 3.2.6.: [F03, F06, F12, F13, F82-OP1.2] [F03-OP3.1] [F02, F03, F06, F12, F13, F82-OS1.2] [F02, F03, F05, F06, F10, F11, F12, F82-OS1.5] [F30-OS3.1] [F11, F12-OS3.7]</p> <p>As applied to health requirements for <i>buildings</i> in Section 3.7.: [F74-OA2] [F50-OH1.1] [F40, F72-OH2.1] [F70-OH2.2] [F71-OH2.3] [F40, F41-OH2.4] [F101-OH6] [F102-OH7] [F01-OP1.1] [F01-OS1.1] [F20, F30-OS3.1] [F32-OS3.3] [F43, F44-OS3.4]</p> <p>As applied to <i>public pools</i> in Section 3.11.: [F74-OA2] [F50-OH1.1] [F72-OH2.1] [F46, F70-OH2.2] [F40, F41, F45, F71, F122-OH2.3] [F40, F41-OH2.4] [F101-OH6] [F01-OS1.1] [F04-OS1.3] [F03-OS2.1] [F12, F30, F34, F36, F120, F121, F123, F124-OS3.1] [F31-OS3.2] [F32, F34-OS3.3] [F34, F43, F44, F81, F122-OS3.4] [F10, F11, F12, F34, F123-OS3.7]</p> <p>As applied to <i>public spas</i> in Section 3.12.: [F74-OA2] [F46-OH2.2] [F40, F41, F70, F71, F72, F81, F122-OH2.3] [F40, F41-OH2.4] [F11, F12, F13, F30, F34, F36, F81, F120, F121, F123, F124-OS3.1] [F43, F81, F122-OS3.4] [F10, F34, F123-OS3.7]</p> <p>As applied to required ventilation for <i>buildings</i> in Sentence 6.2.2.1.(2): [F50-OH1.1]</p> <p>As applied to Sentence 6.2.3.9.(1): [F40-OH1.1] [F44-OS1.1]</p> <p>As applied to Sentence 6.2.4.7.(10): [F40-OH1.1] [F44-OS1.1]</p> <p>As applied to Subsection 9.5.1.: [F10-OS3.7]</p> <p>As applied to Articles 9.5.3.1. to 9.5.10.1.: [F70, F71-OH2.3] [F101-O H6] [F30-OS3.1] [F10-OS3.7]</p>

Acceptable Solution	Objectives and Functional Statements
(2) (Cont'd)	<p>As applied to windows and skylights in Part 9 <i>buildings</i> in Section 9.7.:</p> <p>[F55, F61, F62, F63, F80, F81, F82-OH1.1] [F51, F53, F54, F55, F61, F62, F63, F80, F82-OH1.2] [F61, F62, F63-OH1.3]</p> <p>[F102-OH7]</p> <p>[F42-OP2.3]</p> <p>[F03, F20-OS1.2] [F10-OS1.5]</p> <p>[F20-OS2.1] [F20, F21, F42, F61, F63-OS2.3]</p> <p>[F30-OS3.1] [F10, F30-OS3.7]</p> <p>[F34-OS4.1]</p> <p>[F131-OR2]</p> <p>As applied to flame spread limits in Part 9 <i>buildings</i> Subsection 9.10.17.:</p> <p>[F01, F02-OS1.2] [F01, F02, F05-OS1.5]</p> <p>As applied to plumbing facilities serving Part 9 <i>dwelling units</i> in Section 9.31.:</p> <p>[F44, F62-OH1.1] [F40, F41, F62-OH1.2, OH1.3]</p> <p>[F70, F71, F72, F80-OH2.1] [F41-OH2.2] [F70, F71, F72, F80, F81-OH2.3]</p> <p>[F01-OS1.1]</p> <p>[F31, F80-OS2.3]</p> <p>[F20-OS3.1]</p> <p>As applied to ventilation in Part 9 <i>residential occupancies</i> in Section 9.32.:</p> <p>[F40, F42, F50, F52, F53, F61, F80, F81, F82-OH1.1] [F42, F51, F52, F80, F81-OH1.2]</p> <p>[F42, F80-OH2.5]</p> <p>[F82-OP1.1]</p> <p>[F131-OR2]</p> <p>[F02, F03, F80, F82-OS1.1]</p> <p>[F42, F53, F61, F63-OS2.3]</p> <p>[F40, F43, F44, F50, F53, F81-OS3.4]</p> <p>As applied to Subsection 9.34.1.:</p> <p>[F01-OS1.1]</p> <p>[F10-OS3.1] [F32, F81-OS3.3] Applies to electrical facilities in Part 9 <i>buildings</i>.</p> <p>As applied to Subsection 9.34.2.:</p> <p>[F30-OS3.1] Applies to lighting outlets for Part 9 <i>buildings</i>.</p> <p>[F34-OS4.2] Applies to lighting outlets for Part 9 <i>buildings</i>.</p> <p>As applied to Subsection 9.34.3.:</p> <p>[F30-OS3.1] [F10-OS3.7] Applies to emergency lighting for Part 9 <i>buildings</i>.</p>
(3)	<p>As applied to fire alarm systems in Subsection 3.2.4.:</p> <p>[F12, F13, F81, F82-OP1.2]</p> <p>[F02, F03, F11, F12, F13, F81, F82-OS1.2] [F11, F13-OS1.4] [F10, F11, F12, F13, F81, F82-OS1.5]</p> <p>[F11, F12-OS3.7] Applies to voice communication systems.</p> <p>As applied to smoke control measures, and at least one elevator to permit transport of fire fighters to all floors in hotels whose floor level is more than 18 m high, measured between grade and the floor level of the top storey in Subsection 3.2.6.:</p> <p>[F02, F03, F06, F12, F13, F82-OP1.2]</p> <p>[F03-OP3.1]</p> <p>[F02, F03, F06, F12, F13, F82-OS1.2] [F02, F03, F05, F06, F10, F12-OS1.5]</p> <p>[F30-OS3.1]</p> <p>As applied to lighting of exits, lighting of access to exits and emergency lighting in Subsection 3.2.7.:</p> <p>[F40-OH2.4] Applies to the requirement for a suitably identified shut-off valve outside the <i>building</i>.</p> <p>[F01-OP1.1] [F01, F02, F03, F06, F12, F81-OP1.2]</p> <p>[F02-OP3.1]</p> <p>[F12-OS1.1] Applies to the requirement for a suitably identified shut-off valve outside the <i>building</i>.</p> <p>[F02, F03, F06, F10, F11, F12, F81-OS1.2] [F02, F03, F06, F10, F11, F12, F81-OS1.5]</p> <p>[F02, F06, F30, F81-OS3.1] [F36-OS3.6] [F10, F11, F12, F81-OS3.7]</p> <p>As applied to access to exit widths based on <i>occupant load</i> in Article 3.3.1.16.:</p> <p>[F10-OS3.7]</p> <p>As applied to door release hardware in Article 3.3.1.12.:</p> <p>[F73-OA1]</p> <p>[F30-OS3.1]</p> <p>[F10, F12-OS3.7]</p>

Acceptable Solution	Objectives and Functional Statements
(3) (Cont'd)	<p>As applied to travel distance in Article 3.4.2.4.: [F10-OS3.7]</p> <p>As applied to number of <i>exits</i> in Articles 3.4.2.3. and 3.4.2.5.: [F05, F10-OS1.5] [F10-OS3.7]</p> <p>As applied to <i>exit</i> widths based on <i>occupant load</i> in Article 3.4.3.2.: [F12-OP1.2] [F12-OS1.2] [F30-OS3.1] [F10, F12-OS3.7]</p> <p>As applied to <i>exit</i> signs in Articles 3.4.5.1. and 3.4.5.2.: [F10, F81-OS3.7]</p> <p>As applied to door release hardware in Article 3.4.6.15.: [F73-OA1] [F02-OS1.2] [F10, F81-OS1.5] [F10, F81-OS3.7]</p> <p>As applied to access to <i>exit</i> widths based on <i>occupant load</i> in Subsection 9.9.3.: [F30-OS3.1] [F10-OS3.7]</p> <p>As applied to <i>exit</i> widths based on <i>occupant load</i> in Subsection 9.9.3.: [F30-OS3.1] [F10-OS3.7]</p> <p>As applied to travel distance in Article 9.9.9.1.: [F10-OS3.7]</p> <p>As applied to number of <i>exits</i> in Articles 9.9.8.2. and 9.9.9.2.: [F10-OS3.7]</p> <p>As applied to exit signs in subsection 9.9.10.: [F10-OS1.5] [F10-OS3.7] [F73-OA1]</p> <p>As applied to lighting of exits, lighting of access to exits and emergency lighting in Article 9.9.11.: [F30-OS3.1] [F10-OS3.7]</p> <p>As applied to fire alarm systems in Subsection 9.10.18.: [F02-OS1.2] Applies to a <i>sprinklered building</i>. [F03, F11-OS1.2] [F11-OS1.5]</p> <p>As applied to smoke alarms in Subsection 9.10.19.: [F11, F81-OS1.4] [F11, F81, F82-OS1.5]</p>
(4)	<p>As applied to <i>fire separations</i> in Article 3.1.3.1.: [F03-OP1.2] [F03-OS1.2]</p> <p>As applied to Table 11.4.3.4.B.: [F140-OC]</p>
(5)	
(6)	<p>[F02, F04-OP1.2, OP1.3] [F02, F04-OS1.2, OS1.3]</p>
11.4.3.5.	Plumbing
(1)	<p>[F140-OC]</p> <p>[F20-OE] [F20-OE] Applies to drainage piping. [F20-OE] Applies to underground drainage piping. [F20, F81, F113-OE] [F40-OE] [F44-OE] [F44-OE] Applies to oil interceptors. [F44, F81, F112-OE] [F81-OE] Applies to underground drainage piping. [F81, F112-OE] [F111-OE] Applies to drainage systems served by a sewage system.</p>

Acceptable Solution	Objectives and Functional Statements
(1) (Cont'd)	<p>[F20-OH1.1] [F20-OH1.1] Applies to vent piping. [F20, F43, F81-OH1.1] [F20, F43, F81-OH1.1] Applies to venting system. [F20, F43, F81-OH1.1] Applies to bell and spigot joints in venting systems. [F20, F81-OH1.1] [F21-OH1.1] [F40-OH1.1] [F40, F41, F50-OH1.1] Applies to the requirement for ventilation. [F40, F81-OH1.1] [F41-OH1.1] [F41, F81-OH1.1] Applies to vent pipes. [F43-OH1.1] [F43, F80, F81-OH1.1] Applies to venting system. [F43, F81-OH1.1] Applies to venting system. [F44, F81-OH1.1] [F80-OH1.1] [F81-OH1.1] [F81-OH1.1] Applies to venting system. [F31-OH1.2] [F20-OH1.3] [F20, F80, F81-OH1.3] [F61-OH1.3] [F61, F80-OH1.3] [F62-OH1.3] [F62, F81-OH1.3] [F80, F81-OH1.3] [F81-OH1.3] Applies to water pipes.</p>
	<p>[F20-OH2.1] [F20-OH2.1] Applies to drainage piping. [F20, F80, F81, F113-OH2.1] [F20, F80, F81, F113-OH2.1] Applies to building sewer. [F20, F80, F81, F113-OH2.1] Applies to drainage system. [F20, F80, F81, F113-OH2.1] Applies to Waste Fittings. [F20, F81-OH2.1] Applies to drainage piping. [F20, F81-OH2.1] Applies to bell and spigot joints in drainage systems. [F21-OH2.1] [F40-OH2.1] [F41, F81-OH2.1] [F43-OH2.1] [F45-OH2.1] [F62-OH2.1] [F62, F70-OH2.1] [F70-OH2.1] [F72-OH2.1] [F80-OH2.1] [F80, F81-OH2.1] Applies to drainage system. [F80, F81, F113-OH2.1] [F80, F81, F113-OH2.1] Applies to drainage system. [F81-OH2.1] [F81-OH2.1] Applies to drainage system. [F81, F113-OH2.1] [F20-OH2.2] [F20-OH2.2] Applies to water piping. [F20, F46, F80, F81-OH2.2] [F20, F46, F80, F81-OH2.2] Applies to water piping. [F20, F46, F80, F81-OH2.2] Applies to Supply Fittings. [F20, F46, F81-OH2.2] Applies to water piping. [F20, F80, F81-OH2.2] [F20, F81-OH2.2] [F21-OH2.2]</p>

Acceptable Solution	Objectives and Functional Statements
(1) (Cont'd)	[F41, F46-OH2.2] [F46-OH2.2] [F46-OH2.2] Applies to Water Systems. [F46, F70-OH2.2] [F46, F70, F81-OH2.2] [F46, F80, F81-OH2.2] [F46, F80, F81-OH2.2] Applies to water piping. [F46, F81-OH2.2] [F46, F81-OH2.2] Applies to water piping. [F70-OH2.2] [F70, F80-OH2.2] [F70, F81-OH2.2] [F80-OH2.2] [F81-OH2.2] Applies to the size of air break. [F81-OH2.2] Applies to water service pipe. [F81-OH2.2] Applies to private water supply. [F81-OH2.2] Applies to water system. [F82-OH2.2] [F71-OH2.3] [F71, F72-OH-2.3] Applies to equipment. [F72-OH2.3] [F40-OH2.4] [F40, F46-OH2.4] [F41-OH2.4] [F41-OH2.4] Applies to floor drains in garbage rooms. [F41, F81-OH2.4] [F63-OH2.4] [F81-OH2.4] [F42-OH2.5] [F81-OH2.6] Applies to drainage pipe. [F81-OH2.6] Applies to private sewers. [F20-OH2.1, OH2.2] [F20, F46, F80, F81, F113-OH2.1, OH2.2] [F80-OH2.1, OH2.2] [F80-OH2.1, OH2.2, OH2.3, OH2.4] [F82-OH2.1, OH2.2, OH2.3, OH2.4] Applies to the need for maintenance. [F81-OH2.1, OH2.2, OH2.4] [F20, F81-OH2.1, OH2.3] [F20, F81, F113-OH2.1, OH2.3] [F80-OH2.1, OH2.3] Applies to Drainage Systems. [F81-OH2.1, OH2.3, OH2.4] [F81, F82-OH2.1, OH2.3, OH2.4] [F40-OH2.1, OH2.4] [F40, F41-OH2.1, OH2.4]
	[F41, F43-OH2.1, OH2.4] [F41, F81-OH2.1, OH2.4] [F43-OH2.1, OH2.4] [F80-OH2.1, OH2.4] [F80, F81-OH2.1, OH2.4] [F81-OH2.1, OH2.4] [F82-OH2.1, OH2.4] [F20, F80, F81-OH2.1, OH2.6] [F20, F80, F81, F113-OH2.1, OH2.6] [F20, F81-OH2.1, OH2.6] [F81-OH2.2, OH2.4] [F41, F81-OH2.4, OH2.5]
	[F20-OH4]
	[F43-OH5] [F44-OH5] [F44-OH5] Applies to oil interceptors. [F81-OH5]

Acceptable Solution	Objectives and Functional Statements
(1) (Cont'd)	[F20-OS2.2, OS2.3]
	[F01-OP1.1] [F01-OP1.1] Applies to oil interceptors. [F01, F40, F81-OP1.1] [F20, F81-OP1.1] [F02, F12, F81-OP1.2] [F12-OP1.4]
	[F61-OP2.3] [F61, F80-OP2.3] [F61, F81-OP2.3] [F62-OP2.3] [F63-OP2.3] [F80-OP2.3] [F81-OP2.3]
	[F20-OP5] [F20, F31, F46, F80, F81-OP5] [F20, F46, F80, F81-OP5] [F20, F46, F80, F81-OP5] Applies to Supply Fittings. [F20, F46, F80, F81-OP5] Applies to water piping. [F20, F46, F80, F81, F113-OP5] [F20, F46, F81-OP5] [F20, F46, F81-OP5] Applies to water piping. [F20, F80, F81-OP5] [F20, F80, F81-OP5] Applies to drainage system. [F20, F80, F81, F113-OP5] [F20, F80, F81, F113-OP5] Applies to drainage system. [F20, F80, F81, F113-OP5] Applies to Waste Fittings. [F20, F81-OP5] [F20, F81-OP5] Applies to drainage system. [F20, F81-OP5] Applies to bell and spigot joints in drainage systems. [F20, F81, F113-OP5] [F21-OP5] [F21, F61, F81-OP5] [F40-OP5] [F46-OP5] [F46, F80, F81-OP5] [F46, F80, F81-OP5] Applies to water piping. [F62-OP5] [F62, F72-OP5] [F72-OP5]
	[F80-OP5] [F80, F81-OP5] [F80, F81-OP5] Applies to drainage system. [F80, F81, F113-OP5] [F80, F81, F113-OP5] Applies to drainage system. [F81-OP5] [F81-OP5] Applies to water pipes. [F81-OP5] Applies to Drainage Systems. [F81, F113-OP5] [F81, F113-OP5] Applies to drainage pipes. [F82-OP5]
	[F01-OS1.1] [F01-OS1.1] Applies to oil interceptors. [F01, F40, F81-OS1.1] [F01, F81-OS1.1] [F20, F81-OS1.1] [F81-OS1.1] [F02, F12, F81-OS1.2] [F12-OS1.4]
	[F20, F81-OS2.1] [F20, F81-OS2.3]
	[F20-OS3.1] [F20, F30, F80-OS3.1] [F30-OS3.1] [F30-OS3.1] Applies to the requirement for lighting. [F80-OS3.1] [F81-OS3.1] [F20, F81-OS3.2] [F31-OS3.2] [F31, F81-OS3.2] [F31, F81-OS3.2] Applies to pipes containing hot water. [F31, F81-OS3.2] Applies to pressure vessels containing hot water. [F81-OS3.2]

Acceptable Solution	Objectives and Functional Statements
(1) (Cont'd)	[F32-OS3.3] [F40, F80-OS3.4] [F43-OS3.4] Applies to equipment. [F44-OS3.4] [F81-OS3.4] [F36-OS3.6] [F40-OR1] [F130-OR1]
11.4.3.6.	Sewage Systems
(1)	[F81, F110, F111-OE] [F81, F111-OE] [F82-OE] [F82, F110-OE] [F82, F111-OE] [F104, F110, F111-OE] [F110-OE] [F110, F111-OE] [F110, F111, F112-OE] [F110, F112-OE] [F111-OE] [F111, F112-OE] [F111, F113-OE] [F112-OE] [F50-OH1.1] [F82-OH2.1] [F82, F111-OH2.1] [F104, F110, F111-OH2.1] [F110-OH2.1] [F110, F111-OH2.1] [F110, F111, F112 -OH2.1] [F110, F112-OH2.1] [F111-OH2.1] [F111, F112-OH2.1] [F40-OH2.4] [F42-OH2.5] [F113-OH2.6] [F81, F110, F111-OH5] [F81, F111-OH5] [F82-OH5] [F82, F110-OH5] [F82, F111-OH5] [F104, F110, F111-OH5] [F110-OH5] [F110, F111-OH5] [F110, F111, F112-OH5] [F110, F112-OH5] [F111-OH5] [F111, F112-OH5] [F111, F113-OH5] [F112-OH5] [F101-OH6] [F20-OP2.3] [F81-OP2.6] [F104, F110, F111-OR2] [F20-OS2.1] [F20-OS2.2] [F30-OS3.1]

Acceptable Solution	Objectives and Functional Statements
11.4.3.7.	Extension of Buildings of Combustible Construction
(1)	
11.5.1.1.	Compliance Alternatives
(1)	
(2)	

Table 12
Objectives and Functional Statements Attributed to the Acceptable Solutions in Part 12 of Division B

Acceptable Solution	Objectives and Functional Statements
12.1.1.1.	Scope
(1)	
12.1.1.2.	Application
(1)	
12.2.1.1.	Energy Efficiency Design Before January 1, 2017
(1)	
(2)	[F131-OR2] [F131-OR1, OR1.2]
(3)	(a) [F131-OR2] [F131-OR1, OR1.2] (b) [F131-OR1.2]
(4)	
12.2.1.2.	Energy Efficiency Design After December 31, 2016
(1)	
(2)	[F131-OR2] [F131-OR1, OR1.2]
(3)	[F131-OR2] [F131-UR1, OR1.2]
(4)	
12.2.2.1.	Carbon Dioxide Equivalents
(1)	[F131-OR1, OR1.2]
(2)	
12.2.3.1.	Peak Electric Demand
(1)	[F131-OR1, OR1.2] [F133-OR2.1]
(2)	
12.2.4.1.	Motion Sensors
(1)	
(2)	[F30-OS3.1] [F10-OS3.7]
(3)	[F30-OS3.1] [F10-OS3.7]
12.3.1.1.	Application
(1)	
12.3.1.2.	Windows and Sliding Glass Doors
(1)	[F131-OR1.2]
r6 12.3.1.3.	Temperature Control in Houses and Dwelling Units
(1)	[F131-OR1.2]
(2)	(a) [F131-OR1.2] [F133-OR2.1] (b) [F131-OR1.2] [F133-OR2.1] (c) [F131-OR1.2] [F133-OR2.1]
(3)	[F131-OR1.2] [F132-OR2.1]
12.3.1.4.	Hot Water Piping Insulation
(1)	[F131-OR1.2] [F132-OR2.1]
(2)	[F131-OR1.2] [F132-OR2.1]
(3)	[F131-OR1.2] [F132-OR2.1]
r6 12.3.1.5.	Residential Furnaces
(1)	[F131-OR1.2] [F132-OR2.1] [F150-OE1.1]
r6 12.3.1.6.	Energy Supply for Kitchen and Laundry Facilities
(1)	[F131-OR1.2]
12.4.1.1.	Plumbing Systems
(1)	

MMAH Supplementary Standard SB-1

Climatic and Seismic Data

January 15, 2019 update

COMMENCEMENT

MMAH Supplementary Standard SB-1 comes into force on the 1st day of January, 2014.

r5 SB-1 as amended by Ontario Regulation 191/14 comes into force on the 1st day of January, 2015.

r11.1 SB-1 as amended by Ontario Regulation 88/19 comes into force on the 1st day of January, 2020.

© Copyright

© Copyright Queen's Printer for Ontario 2019

All rights reserved.

Questions regarding copyright, including reproduction and distribution, may be directed to the Director,
Building and Development Branch of the Ministry of Municipal Affairs and Housing.

r11.1 SB-1 Climatic and Seismic Data

Introduction

The great diversity of climate in Ontario has a considerable effect on the performance of buildings; consequently, building design must reflect this diversity. This Supplementary Standard briefly describes how climatic design values are computed and provides recommended design data for a number of cities, towns, and lesser populated locations. Through the use of such data, appropriate allowances can be made for climate variations in different localities of Ontario and the Building Code can be applied provincially.

The climatic design data provided in Table 2 are based on weather observations collected by the Atmospheric Environment Service, Environment Canada. The climatic design data were researched and analyzed for the Canadian Commission on Building and Fire Codes by Environment Canada .

As it is not practical to list values for all municipalities in Ontario, recommended climatic design values for locations not listed can be obtained by contacting the Atmospheric Environment Service, Environment Canada, 4905 Dufferin Street, Downsview, Ontario M3H 5T4, (416) 739-4365. It should be noted, however, that these recommended values may differ from the values accepted by municipal building authorities based on local experience.

The seismic design data in Table 3 has been provided by the Geological Survey of Canada of Natural Resources Canada. Information for municipalities not listed may be obtained at www.earthquakescanada.nrcan.gc.ca, or by writing to the Geological Survey of Canada at 7 Observatory Crescent, Ottawa, Ontario KIA OY3, or at P.O. Box 6000, Sidney, B.C. V8L 4B2.

General

The choice of climatic elements tabulated in this Supplementary Standard and the form in which they are expressed have been dictated largely by the requirements for specific values in several sections of the Building Code. These elements include the Ground Snow Loads, Wind Pressures, Design Temperatures, Heating Degree-Days, One-Day and 15-Minute Rainfalls, the Annual Total Precipitation values. The following notes briefly explain the significance of these particular elements in building design, and indicate which weather observations were used and how they were analyzed to yield the required design values.

Climatic design data in Table 2 provides weather information for over 230 locations which have been chosen based on a variety of reasons. Many incorporated cities and towns with significant populations are included unless located close to larger cities. For sparsely populated areas, many smaller towns and villages are listed. Other locations have been added to the list when the demand for climatic design recommendations at these sites has been significant. The named locations refer to the specific latitude and longitude defined by the Gazetteer of Canada (Natural Resources Canada), available from Publishing and Depository Services Canada, Public Works and Government Services Canada, Ottawa, Ontario KIA OS5.

Almost all of the weather observations used in preparing Table 2 were, of necessity, observed at inhabited locations. To estimate design values for arbitrary locations, the observed or computed values for the weather stations were mapped and interpolated appropriately. Where possible, adjustments have been applied for the influence of elevation and known topographical effects. Such influences include the tendency of cold air to collect in depressions, for precipitation to increase with elevation, and for generally stronger winds near large bodies of water. Elevations have been added to the Table because of their potential to significantly influence climatic design values. The elevations are given in metres and refer to heights above sea level.

Since interpolation from the values in Table 2 to other locations may not be valid due to local and other effects, Environment Canada will provide climatic design element recommendations for locations not listed in Table 2. Local effects are particularly significant in mountainous areas, where the values apply only to populated valleys and not to the mountain slopes and high passes, where very different conditions are known to exist.

Changing and Variable Climates

Climate is not static. At any location, weather and climatic conditions vary from season to season, year to year, and over longer time periods (climate cycles). This has always been the case. Evidence is mounting that the climates of Ontario are changing and will continue to change significantly in the future. When estimating climatic design loads, this variability can be considered using appropriate statistical analysis, data records spanning sufficient periods, and meteorological judgement. The analysis generally assumes that the past climate will be representative of the future climate.

Past and ongoing modifications to atmospheric chemistry (from greenhouse gas emissions and land use changes) are expected to alter most climatic regimes in the future despite the success of the most ambitious greenhouse gas mitigation plans.⁽¹⁾ Some regions could see an increase in the frequency and intensity of many weather extremes, which will accelerate weathering processes. Consequently, many buildings will need to be designed, maintained and operated to adequately withstand ever changing climatic loads.

Similar to global trends, the last decade in Canada was noted as the warmest in instrumented record. Canada has warmed, on average, at almost twice the rate of the global average increase, while the western Arctic is warming at a rate that is unprecedented over the past 400 years.⁽¹⁾ Mounting evidence from Arctic communities indicates that rapid changes to climate in the North have resulted in melting permafrost and impacts from other climate changes have affected nearly every type of built structure. Furthermore, analyses of Canadian precipitation data shows that many regions of the country have, on average, also been tending towards wetter conditions.⁽¹⁾ In the United States, where the density of climate monitoring stations is greater, a number of studies have found an unambiguous upward trend in the frequency of heavy to extreme precipitation events, with these increases coincident with a general upward trend in the total amount of precipitation. Climate change model results, based on an ensemble of global climate models worldwide, project that future climate warming rates will be greatest in higher latitude countries such as Canada.⁽²⁾

January Design Temperatures

A building and its heating system should be designed to maintain the inside temperature at some pre-determined level. To achieve this, it is necessary to know the most severe weather conditions under which the system will be expected to function satisfactorily. Failure to maintain the inside temperature at the pre-determined level will not usually be serious if the temperature drop is not great and if the duration is not long. The outside conditions used for design should, therefore, not be the most severe in many years, but should be the somewhat less severe conditions that are occasionally but not greatly exceeded.

The January design temperatures are based on an analysis of January air temperatures only. Wind and solar radiation also affect the inside temperature of most buildings and may need to be considered for energy-efficient design.

The January design temperature is defined as the lowest temperature at or below which only a certain small percentage of the hourly outside air temperatures in January occur. In the past, stations with records from all or part of the period 1951-1966 formed the basis for calculation of the 2.5 and 1% January temperatures. Where necessary, the data were adjusted for consistency. Since most of the temperatures were observed at airports, design values for the core areas of large cities could be 1° or 2°C milder, although the values for the fringe areas are probably about the same as for the airports. No adjustments were made for this urban heat island effect. The design values for the next 20 to 30 years will probably differ from these tabulated values due to year-to-year climate variability and global climate change resulting from the impact of human on atmospheric chemistry.

The design temperatures were reviewed and updated using hourly temperature observations from stations for a 25-year period up to 2006 with at least 8 years of complete data. These data are consistent with data shown for Canadian locations in the 2009 Handbook of Fundamentals⁽³⁾ published by the American Society of Heating, Refrigerating, and Air-Conditioning Engineers (ASHRAE). The most recent 25 years of record were used to provide a balance between accounting for trends in the climate and the sampling variation owing to year-to-year variation. The 1% and 2.5% values used for the design conditions represent percentiles of the cumulative frequency distribution of hourly temperatures and correspond to January temperatures that are colder for 8 and 19 hours, respectively, on average over the long term.

The 2.5% January design temperature is the value ordinarily used in the design of heating systems. In special cases, when the control of inside temperature is more critical, the 1% value may be used. Other temperature-dependent climatic design parameters may be considered for future issues of this document.

July Design Temperatures

A building and its cooling and dehumidifying system should be designed to maintain the inside temperature and humidity at certain pre-determined levels. To achieve this, it is necessary to know the most severe weather conditions under which the system is expected to function satisfactorily. Failure to maintain the inside temperature and humidity at the pre-determined levels will usually not be serious if the increases in temperature and humidity are not great and the duration is not long. The outside conditions used for design should, therefore, not be the most severe in many years, but should be the somewhat less severe conditions that are occasionally but not greatly exceeded.

The summer design temperatures in this Supplementary Standard are based on an analysis of July air temperatures and humidities. Wind and solar radiation also affect the inside temperature of most buildings and may, in some cases, be more important than the outside air temperature. More complete summer and winter design information can be obtained from Environment Canada.

The July design dry-bulb and wet-bulb temperatures were reviewed and updated using hourly temperature observations from stations for a 25-year period up to 2006. These data are consistent with data shown for Canadian locations in the 2009 Handbook of Fundamentals⁽³⁾ published by ASHRAE. As with January design temperatures, data from the most recent 25-year period were analyzed to reflect any recent climatic changes or variations. The 2.5% values used for the dry- and wet-bulb design conditions represent percentiles of the cumulative frequency distribution of hourly dry- and wet-bulb temperatures and correspond to July temperatures that are higher for 19 hours on average over the long term.

Heating Degree-Days

The rate of consumption of fuel or energy required to keep the interior of a small building at 21°C when the outside air temperature is below 18°C is roughly proportional to the difference between 18°C and the outside temperature. Wind speed, solar radiation, the extent to which the building is exposed to these elements and the internal heat sources also affect the heat required and may have to be considered for energy-efficient design. For average conditions of wind, radiation, exposure, and internal sources, however, the proportionality with the temperature difference generally still holds.

Since the fuel required is also proportional to the duration of the cold weather, a convenient method of combining these elements of temperature and time is to add the differences between 18°C and the mean temperature for every day in the year when the mean temperature is below 18°C. It is assumed that no heat is required when the mean outside air temperature for the day is 18°C or higher.

Although more sophisticated computer simulations using other forms of weather data have now almost completely replaced degree-day-based calculation methods for estimating annual heating energy consumption, degree-days remain a useful indicator of relative severity of climate and can form the basis for certain climate-related code requirements.

The degree-days below 18°C were compiled for stations for the 25-year period ending in 2006. This analysis period is consistent with the one used to derive the design temperatures described above and with the approach used by ASHRAE.⁽³⁾

A difference of only one Celsius degree in the mean annual temperature will cause a difference of 250 to 350 in the Celsius degree-days. Since differences of 0.5 of a Celsius degree in the mean annual temperature are quite likely to occur between two stations in the same town, heating degree-days cannot be relied on to an accuracy of less than about 100 degree-days.

Heating degree-day values for the core areas of larger cities can be 200 to 400 degree-days less (warmer) than for the surrounding fringe areas. The observed degree-days, which are based on daily temperature observations, are often most representative of rural settings or the fringe areas of cities.

Climatic Data for Energy Consumption Calculations

The climatic elements tabulated in this Supplementary Standard represent commonly used design values but do not include detailed climatic profiles, such as hourly weather data. Where hourly values of weather data are needed for the purpose of simulating the annual energy consumption of a building, they can be obtained from multiple sources, such as Environment Canada, Natural Resources Canada, the Regional Conservation Authority and other such public agencies that record this information. Hourly weather data are also available from public and private agencies that format this information for use with annual energy consumption simulation software; in some cases, these data have been incorporated into the software.

Snow Loads

The roof of a building should be able to support the greatest weight of snow that is likely to accumulate on it in many years. Some observations of snow on roofs have been made in Canada, but not enough to form the basis for estimating roof snow loads throughout the country. Similarly, observations of the weight, or water equivalent, of the snow on the ground have not been available in digital form in the past. The observations of roof loads and water equivalents are very useful, as noted below, but the measured depth of snow on the ground is used to provide the basic information for a consistent set of snow loads.

The estimation of the design snow load on a roof from snow depth observations involves the following steps:

1. The depth of snow on the ground, which has an annual probability of exceedance of 1-in-50, is computed.
2. The appropriate unit weight is selected and used to convert snow depth to loads, S_s .
3. The load, S_r , which is due to rain falling on the snow, is computed.
4. Because the accumulation of snow on roofs is often different from that on the ground, adjustments are applied to the ground snow load to provide a design snow load on a roof.

The annual maximum depth of snow on the ground has been assembled from stations for which data has been recorded by the Atmospheric Environment Service (AES). The period of record used varied from station to station, ranging from 7 to 38 years. These data were analyzed using a Gumbel extreme value distribution fitted using the method of moments⁽⁴⁾ as reported by Newark et al.⁽⁵⁾ The resulting values are the snow depths, which have a probability of 1-in-50 of being exceeded in any one year.

The specific weight of old snow generally ranges from 2 to 5 kN/m³, and it is usually assumed in Canada that 1 kN/m³ is the average for new snow. Average unit weights of the seasonal snow pack have been derived for different regions across the country⁽⁶⁾ and an appropriate value has been assigned to each weather station. Typically, the values average 2.01 kN/m³ east of the continental divide (except for 2.94 kN/m³ north of the treeline), and range from 2.55 to 4.21 kN/m³ west of the divide. The product of the 1-in-50 snow depth and the average unit weight of the seasonal snow pack at a station is converted to the snow load (SL) in units of kilopascals (kPa).

Except for the mountainous areas of western Canada, the values of the ground snow load at AES stations were normalized assuming a linear variation of the load above sea level in order to account for the effects of topography. They were then smoothed using an uncertainty-weighted moving-area average in order to minimize the uncertainty due to snow depth sampling errors and site-specific variations. Interpolation from analyzed maps of the normalized values yielded a value for each location in Table 2, which could then be converted to the listed code values (S_s) by means of an equation in the form:

$$S_s = \text{smooth normalized SL} + bZ$$

where b is the assumed rate of change of SL with elevation at the location and Z is the location's elevation above mean sea level (MSL). Although they are listed in Table 2 to the nearest tenth of a kilopascal, values of S_s typically have an uncertainty of about 20%. Areas of sparse data in northern Canada were an exception to this procedure. In these regions, an analysis was made of the basic SL values. The effects of topography, variations due to local climates, and smoothing were all subjectively assessed. The values derived in this fashion were used to modify those derived objectively.

Tabulated values cannot be expected to indicate all the local differences in S_s . For this reason, especially in complex terrain areas, values should not be interpolated from Table 2 for unlisted locations. The values of S_s in Table 2 apply for the elevation and the latitude and longitude of the location, as defined by the Gazetteer of Canada. Values at other locations can be obtained from Environment Canada.

The heaviest loads frequently occur when the snow is wetted by rain, thus the rain load, S_r , was estimated to the nearest 0.1 kPa and is provided in Table 2. When values of S_r are added to S_s , this provides a 1-in-50-year estimate of the combined ground snow and rain load. The values of S_r are based on an analysis from weather station values of the 1-in-50-year one-day maximum rain amount. This return period is appropriate because the rain amounts correspond approximately to the joint frequency of occurrence of the one-day rain on maximum snow packs. For the purpose of estimating rain on snow, the individual observed one-day rain amounts were constrained to be less than or equal to the snow pack water equivalent, which was estimated by a snow pack accumulation model reported by Bruce and Clark.⁽⁷⁾

The results from surveys of snow loads on roofs indicate that average roof loads are generally less than loads on the ground. The conditions under which the design snow load on the roof may be taken as a percentage of the ground snow load are given in Subsection 4.1.6. of Division B of the Building Code. The Code also permits further decreases in design snow loads for steeply sloping roofs, but requires substantial increases for roofs where snow accumulation may be more rapid due to such factors as drifting. Recommended adjustments are given in the User's Guide - NBC 2015, Structural Commentaries (Part 4 of Division B).

The ground snow values, S_s , were updated for this edition of the Building Code using a similar approach to the one used for the ground snow load update in the 1990 edition. The Gumbel extreme value distribution was fitted to the annual maxima of daily snow depth observations made at weather stations, which were compiled from 1990 onward – to as recently as 2012 for some stations – to calculate the 50-year return period snow depth. The 50-year ground snow load was then calculated for each weather station by combining the 50-year snow pack with the assigned snow pack density. The S_s values for each location in Table 2 were compared with the updated weather station values and revised accordingly. As a result, S_s values remain unchanged for about 89% of the locations, have increased for 5.7% of the locations, and have decreased for 5.3% of the locations.

Annual Total Precipitation

Total precipitation is the sum in millimetres of the measured depth of rainwater and the estimated or measured water equivalent of the snow (typically estimated as 0.1 of the measured depth of snow, since the average density of fresh snow is about 0.1 that of water).

The average annual total precipitation amounts in Table 2 have been interpolated from an analysis of precipitation observations from stations for the 30-year period from 1961 to 1990.

Annual Rainfall

The total amount of rain that normally falls in one year is frequently used as a general indication of the wetness of a climate, and is therefore included in this Supplementary Standard.

Rainfall Intensity

Roof drainage systems are designed to carry off rainwater from the most intense rainfall that is likely to occur. A certain amount of time is required for the rainwater to flow across and down the roof before it enters the gutter or drainage system. This results in the smoothing out of the most rapid changes in rainfall intensity. The drainage system, therefore, need only cope with the flow of rainwater produced by the average rainfall intensity over a period of a few minutes, which can be called the concentration time.

In Canada, it has been customary to use the 15-minute rainfall that will probably be exceeded on an average of once in 10 years. The concentration time for small roofs is much less than 15 minutes and hence the design intensity will be exceeded more frequently than once in 10 years. The safety factors in Part 7 of Division B of the Building Code will probably reduce the frequency to a reasonable value and, in addition, the occasional failure of a roof drainage system will not be particularly serious in most cases.

The rainfall intensity values were updated for the 2012 edition of the Building Code using observations of annual maximum 15-minute rainfall amounts from stations with 10 or more years of record, including data up to 2007 for some stations. Ten-year return period values – the 15-minute rainfall having a probability of 1-in-10 of being exceeded in any year – were calculated by fitting the annual maximum values to the Gumbel extreme value distribution⁽⁴⁾ using the method of moments. The updated values are compiled from the most recent short-duration rainfall intensity-duration-frequency (IDF) graphs and tables available from Environment Canada.

It is very difficult to estimate the pattern of rainfall intensity in mountainous areas, where precipitation is extremely variable and rainfall intensity can be much greater than in other types of areas. Many of the observations for these areas were taken at locations in valley bottoms or in extensive, fairly level areas.

One-Day Rainfall

If for any reason a roof drainage system becomes ineffective, the accumulation of rainwater may be great enough in some cases to cause a significant increase in the load on the roof. In the past, when the period during which rainwater could accumulate was unknown, it had been common practice to use the maximum one-day rainfall ever observed for estimating the additional load. Since the length of record for weather stations in Canada is quite variable, the maximum one-day rainfall amounts in previous editions often reflected the variable length of record at nearby stations as much as the climatology. As a result, the maximum values often differed greatly within relatively small areas where little difference should be expected. The current values have been standardized to represent the one-day rainfall amounts that have 1 chance in 50 of being exceeded in any one year or the 1-in-50-year return value one-day rainfalls.

The one-day rainfall values were updated using daily rainfall observations from stations with 10 years or more of record, including data up to 2008 for some stations. The 50-year return period values were calculated by fitting the annual maximum one-day rainfall observations to the Gumbel extreme value distribution using the method of moments.⁽⁴⁾

Rainfall frequency observations can vary considerably over time and space. This is especially true for mountainous areas, where elevation effects can be significant. In other areas, small scale intense storms or local influences can produce significant spatial variability in the data. As a result, the analysis incorporates some spatial smoothing.

Driving Rain Wind Pressure (DRWP)

The presence of rainwater on the face of a building, with or without wind, must be addressed in the design and construction of the building envelope so as to minimize the entry of water into the assembly. Wind pressure on the windward faces of a building will promote the flow of water through any open joints or cracks in the facade.

Driving rain wind pressure (DRWP) is the wind load that is coincident with rain, measured or calculated at a height of 10 m. The values provided in Table 2 represent the loads for which there is 1 chance in 5 of being reached or exceeded in any one year, or a probability of 20% within any one year. Approximate adjustments for height can be made using the values for C_e given in Sentence 4.1.7.3.(5) of Division B as a multiplier.

Because of inaccuracies in developing the DRWP values related to the averaging of extreme wind pressures, the actual heights of recording anemometers, and the use of estimated rather than measured rainfall values, the values are considered to be higher than actual loads.⁽⁸⁾⁽⁹⁾ Thus the actual probability of reaching or exceeding the DRWP in a particular location is less than 20% per year and these values can be considered to be conservative.

DRWP can be used to determine the height to which wind will drive rainwater up enclosed vertical conduits. This provides a conservative estimate of the height needed for fins in window extrusions and end dams on flashings to control water ingress. This height can be calculated as:

$$\text{height of water, mm} = \text{DRWP} / 10, \text{ Pa}$$

Note that the pressure difference across the building envelope may be augmented by internal pressures induced in the building interior by the wind. These additional pressures can be estimated using the information provided in the Commentary entitled *Wind Load and Effects of the User's Guide - NBC 2015, Structural Commentaries (Part 4 of Division B)*.

Wind Effects

All structures need to be designed to ensure that the main structural system and all secondary components, such as cladding and appurtenances, will withstand the pressures and suction caused by the strongest wind likely to blow at that location in many years. Some flexible structures, such as tall buildings, slender towers and bridges, also need to be designed to minimize excessive wind-induced oscillations or vibrations.

At any time, the wind acting upon a structure can be treated as a mean or time-averaged component and as a gust or unsteady component. For a small structure, which is completely enveloped by wind gusts, it is only the peak gust velocity that needs to be considered. For a large structure, the wind gusts are not well correlated over its different parts and the effects of individual gusts become less significant. The *User's Guide - NBC 2015, Structural Commentaries (Part 4 of Division B)* evaluates the mean pressure acting on a structure, provide appropriate adjustments for building height and exposure and for the influence of the surrounding terrain and topography (including wind speed-up for hills), and then incorporate the effects of wind gusts by means of the gust factor, which varies according to the type of structure and the size of the area over which the pressure acts.

The wind speeds and corresponding velocity pressures used in the Code are regionally representative or reference values. The reference wind speeds are nominally one-hour averages of wind speeds representative of the 10 m height in flat open terrain corresponding to Exposure A or open terrain in the terminology of the *User's Guide - NBC 2015, Structural Commentaries (Part 4 of Division B)*. The reference wind speeds and wind velocity pressures are based on long-term wind records observed at a large number of weather stations across Canada.

Reference wind velocity pressures in previous versions of the Code were based mostly on records of hourly averaged wind speeds (i.e, the number of miles of wind passing an anemometer in an hour) from stations across Canada with 10 to 22 years of observations ending in the 1950s. The wind pressure values derived from these measurements represented true hourly wind pressures.

The reference wind velocity pressures were reviewed and updated for the 2012 edition of the Building Code. The primary data set used for the analysis comprised wind records compiled from stations with hourly averaged wind speeds and from stations with aviation (one- or two-minute average) speeds or surface weather (ten-minute average) speeds observed once per hour at the top of the hour; the periods of record used ranged from 10 to 54 years. In addition, peak wind gust records from stations with periods of record ranging from 10 to 43 years were used. Peak wind gusts (gust durations of approximately 3 to 7 seconds) were used to supplement the primary once-per-hour observations in the analysis.

Several steps were involved in updating the reference wind values. Where needed, speeds were adjusted to represent the standard anemometer height above ground of 10 m. The data from years when the anemometer at a station was installed on the top of a lighthouse or building were eliminated from the analysis since it is impractical to adjust for the effects of wind flow over the structure. (Most anemometers were moved to 10 m towers by the 1960s.) Wind speeds of the various observation types—hourly averaged, aviation, surface weather and peak wind gust — were adjusted to account for different measure durations to represent a one-hour averaging period and to account for differences in the surface roughness of flat open terrain at observing stations.

The annual maximum wind speed data was fitted to the Gumbel distribution using the method of moments⁽⁴⁾ to calculate hourly wind speeds having the annual probability of occurrence of 1-in-10 and 1-in-50 (10-year and 50-year return periods). The values were plotted on maps, then analyzed and abstracted for the locations in Table 2.

The wind velocity pressures, q , were calculated in Pascals using the following equation:

$$q = \frac{1}{2} \rho V^2$$

where ρ is an average air density for the windy months of the year and V is wind speed in metres per second. While air density depends on both air temperature and atmospheric pressure, the density of dry air at 0°C and standard atmospheric pressure of 1.2929 kg/m³ was used as an average value for the wind pressure calculations. As explained by Boyd⁽¹⁰⁾, this value is within 10% of the monthly average air densities for most of Canada in the windy part of the year.

As a result of the updating procedure, the 1-in-50 reference wind velocity pressures remain unchanged for most of the locations listed in Table 2; both increases and decreases were noted for the remaining locations. Many of the decreases resulted from the fact that anemometers at most of the stations used in the previous analysis were installed on lighthouses, airport hangers and other structures. Wind speeds on the tops of buildings are often much higher compared to those registered by a standard 10 m tower. Eliminating anemometer data recorded on the tops of buildings from the analysis resulted in lower values at several locations.

Hourly wind speeds that have 1 chance in 10 and 50¹ of being exceeded in any one year were analyzed using the Gumbel extreme value distribution fitted using the method of moments with correction for sample size. Values of the 1-in-30-year wind speeds for locations in Table 2 were estimated from a mapping analysis of wind speeds. The 1-in-10- and 1-in-50-year speeds were then computed from the 1-in-30-year speeds using a map of the dispersion parameter that occurs in the Gumbel analysis.⁽⁴⁾

Table 1 has been arranged to give pressures to the nearest one-hundredth of a kPa and their corresponding wind speeds. The value of " q " in kPa is assumed to be equal to 0.00064645 V^2 , where V is given in m/s.

¹ Wind speeds that have a 1-in-" n "-year chance of being exceeded in any year can be computed from the 1-in-10 and 1-in-50 return values in Table 2 using the following equation:

$$V_{1/n} = \frac{1}{1.4565} \left\{ V_{1/50} + 0.4565 V_{1/10} + \frac{V_{1/50} - V_{1/10}}{1.1339} \times \ln \frac{-0.0339}{\ln(1 - 1/n)} \right\}$$

Seismic Hazard

The parameters used to represent seismic hazard for specific geographical locations in Table 3 are the 5%-damped horizontal spectral acceleration values for 0.2, 0.5, 1.0, 2.0, 5.0 and 10.0 second periods, the horizontal Peak Ground Acceleration (PGA) and the horizontal Peak Ground Velocity (PGV) with all values given for a 2% probability of being exceeded in 50 years. The six spectral parameters are deemed sufficient to define spectra closely matching the shape of the Uniform Hazard Spectra (UHS). Hazard values are mean values based on a statistical analysis of the earthquakes that have been experienced in Canada and adjacent regions.⁽¹¹⁾ The seismic hazard values were updated for the January 1, 2020 amendments to the 2012 Building Code by updating the earthquake catalogue, revising the seismic hazard source zones, adding fault sources for the Cascadia subduction zone and other certain active faults, revising the Ground Motion Prediction Equations (GMPEs),⁽¹²⁾ and using a probabilistic model to combine all inputs.

For most locations, the new GMPEs are the most significant reason for changes in the hazard results from the 2012 Building Code prior to the January 1, 2020 amendments. One exception is for areas of western Canada for which adding the Cascadia subduction source contribution to the model probabilistically causes the most significant change. In general, for locations in eastern Canada, the seismic hazard at long periods has increased while the seismic hazard at short periods has decreased— in some places significantly for areas affected by the Cascadia interface. For other areas, the explicit inclusion of fault sources, such as those in Haida Gwaii and the Yukon, has also affected the estimated hazard.

Further details regarding the representation of seismic hazard can be found in the Commentary on Design for Seismic Effects in the User's Guide - NBC 2015, Structural Commentaries (Part 4 of Division B).

References

- (1) Environment Canada, Climate Trends and Variation Bulletin: 2007, 2008.
- (2) Intergovernmental Panel on Climate Change (IPCC), Climate Change 2007: The Physical Science Basis. Contribution of Working Group I to the Fourth Assessment Report of the Intergovernmental Panel on Climate Change. S. Solomon, D. Qin, M. Manning, Z. Chen, M. Marquis, K.B. Averyt, M. Tignor and H.L. Miller (Eds.) Cambridge University Press, Cambridge, United Kingdom and New York, NY, USA, 996 pp., 2007.
- (3) American Society of Heating, Refrigerating, and Air-Conditioning Engineers, Handbook of Fundamentals, Chapter 14 – Climatic Design Information, Atlanta, GA. 2009.
- (4) Lowery, M.D. and Nash, J.E., A comparison of methods of fitting the double exponential distribution. *J. of Hydrology*, 10 (3), pp. 259-275, 1970.
- (5) Newark, M.J., Welsh, L.E., Morris, R.J. and Dnes, W.V. Revised Ground Snow Loads for the 1990 NBC of Canada. *Can. J. Civ. Eng.*, Vol. 16, No. 3, June 1989.
- (6) Newark, M.J. A New Look at Ground Snow Loads in Canada. Proceedings, 41st Eastern Snow Conference, Washington, D.C., Vol. 29, pp. 59-63, 1984.
- (7) Bruce, J.P. and Clark, R.H. Introduction to Hydrometeorology. Pergammon Press, London, 1966.
- (8) Skerlj, P.F. and Surry, D. A Critical Assessment of the DRWPs Used in CAN/CSA-A440-M90. Tenth International Conference on Wind Engineering, Wind Engineering into the 21st Century, Larsen, Larose & Livesay (eds), 1999 Balkema, Rotterdam, ISBN 90 5809 059 0.
- (9) Cornick, S., Chown, G.A., et al. Committee Paper on Defining Climate Regions as a Basis for Specifying Requirements for Precipitation Protection for Walls. Institute for Research in Construction, National Research Council, Ottawa, April 2001.
- (10) Boyd, D.W. Variations in Air Density over Canada. National Research Council of Canada, Division of Building Research, Technical Note No. 486, June 1967.
- (11) Adams, J., Halchuk, S., Allen, T.I., and Rogers, G.C. Fifth Generation seismic hazard model and values for the 2015 National Building Code of Canada. Geological Survey of Canada Open File, 2014.
- (12) Atkinson, G.M. and Adams, J. Ground motion prediction equations for application to the 2015 Canadian national seismic hazard maps, *Can. J. Civ. Eng.* 40, 988-998, 2013.

Table 1
Wind Speeds

q kPa	V m/s	q kPa	V m/s	q kPa	V m/s	q kPa	V m/s
0.15	15.2	0.53	28.6	0.91	37.5	1.29	44.7
0.16	15.7	0.54	28.9	0.92	37.7	1.30	44.8
0.17	16.2	0.55	29.2	0.93	37.9	1.31	45.0
0.18	16.7	0.56	29.4	0.94	38.1	1.32	45.2
0.19	17.1	0.57	29.7	0.95	38.3	1.33	45.4
0.20	17.6	0.58	30.0	0.96	38.5	1.34	45.5
0.21	18.0	0.59	30.2	0.97	38.7	1.35	45.7
0.22	18.4	0.60	30.5	0.98	38.9	1.36	45.9
0.23	18.9	0.61	30.7	0.99	39.1	1.37	46.0
0.24	19.3	0.62	31.0	1.00	39.3	1.38	46.2
0.25	19.7	0.63	31.2	1.01	39.5	1.39	46.4
0.26	20.1	0.64	31.5	1.02	39.7	1.40	46.5
0.27	20.4	0.65	31.7	1.03	39.9	1.41	46.7
0.28	20.8	0.66	32.0	1.04	40.1	1.42	46.9
0.29	21.2	0.67	32.2	1.05	40.3	1.43	47.0
0.30	21.5	0.68	32.4	1.06	40.5	1.44	47.2
0.31	21.9	0.69	32.7	1.07	40.7	1.45	47.4
0.32	22.2	0.70	32.9	1.08	40.9	1.46	47.5
0.33	22.6	0.71	33.1	1.09	41.1	1.47	47.7
0.34	22.9	0.72	33.4	1.10	41.3	1.48	47.8
0.35	23.3	0.73	33.6	1.11	41.4	1.49	48.0
0.36	23.6	0.74	33.8	1.12	41.6	1.50	48.2
0.37	23.9	0.75	34.1	1.13	41.8	1.51	48.3
0.38	24.2	0.76	34.3	1.14	42	1.52	48.5
0.39	24.6	0.77	34.5	1.15	42.2	1.53	48.6
0.40	24.9	0.78	34.7	1.16	42.4	1.54	48.8
0.41	25.2	0.79	35.0	1.17	42.5	1.55	49.0
0.42	25.5	0.80	35.2	1.18	42.7	1.56	49.1
0.43	25.8	0.81	35.4	1.19	42.9	1.57	49.3
0.44	26.1	0.82	35.6	1.20	43.1	1.58	49.4
0.45	26.4	0.83	35.8	1.21	43.3	1.59	49.6
0.46	26.7	0.84	36.0	1.22	43.4	1.60	49.7
0.47	27.0	0.85	36.3	1.23	43.6	1.61	49.9
0.48	27.2	0.86	36.5	1.24	43.8	1.62	50.1
0.49	27.5	0.87	36.7	1.25	44.0	1.63	50.2
0.50	27.8	0.88	36.9	1.26	44.1	1.64	50.4
0.51	28.1	0.89	37.1	1.27	44.3	1.65	50.5
0.52	28.4	0.90	37.3	1.28	44.5	1.66	50.7
Column 1	2	3	4	5	6	7	8

Table 2
Climatic Design Data

Location	Elevation, m	Design Temperature				Degree Days Below 18°C	15 Min Rainfall, mm	One Day Rainfall, 1/50, mm	Annual Rainfall, mm	Annual Total Precipitation, mm	Driving Rain Wind Pressures, Pa, 1/5	Snow Load, kPa, 1/50		Hourly Wind Pressures, kPa	
		January		July 2.5%								S _s	S _r	1/10	1/50
		2.5%, °C	1%, °C	Dry, °C	Wet, °C										
Ailsa Craig	230	-17	-19	30	23	3840	25	103	800	950	180	2.2	0.4	0.39	0.50
Ajax	95	-20	-22	30	23	3820	23	92	760	825	160	1.0	0.4	0.37	0.48
Alexandria	80	-24	-26	30	23	4600	25	103	800	975	160	2.4	0.4	0.31	0.40
Alliston	220	-23	-25	29	23	4200	28	113	690	875	120	2.0	0.4	0.28	0.36
Almonte	120	-26	-28	30	23	4620	25	97	730	800	140	2.5	0.4	0.32	0.41
Armstrong	340	-37	-40	28	21	6500	23	97	525	725	100	2.7	0.4	0.23	0.30
Arnprior	85	-27	-29	30	23	4680	23	86	630	775	140	2.5	0.4	0.29	0.37
Atikokan	400	-33	-35	29	22	5750	25	103	570	760	100	2.4	0.3	0.23	0.30
Attawapiskat	10	-37	-39	28	21	7100	18	81	450	650	160	2.8	0.3	0.32	0.41
Aurora	270	-21	-23	30	23	4210	28	108	700	800	140	2.0	0.4	0.34	0.44
Bancroft	365	-28	-31	29	23	4740	25	92	720	900	100	3.1	0.4	0.25	0.32
Barrie	245	-24	-26	29	23	4380	28	97	700	900	120	2.5	0.4	0.28	0.36
Barriefield	100	-22	-24	28	23	3990	23	108	780	950	160	2.1	0.4	0.36	0.47
Beaverton	240	-24	-26	30	23	4300	25	108	720	950	120	2.2	0.4	0.28	0.36
Belleville	90	-22	-24	29	23	3910	23	97	760	850	180	1.7	0.4	0.33	0.43
Belmont	260	-17	-19	30	24	3840	25	97	850	950	180	1.7	0.4	0.36	0.47
Big Trout Lake (Kitchenuhmaykoosib)	215	-38	-40	26	20	7450	18	92	400	600	150	3.2	0.2	0.33	0.42
CFB Borden	225	-23	-25	29	23	4300	28	103	690	875	120	2.2	0.4	0.28	0.36
Bracebridge	310	-26	-28	29	23	4800	25	103	830	1050	120	3.1	0.4	0.27	0.35
Bradford	240	-23	-25	30	23	4280	28	108	680	800	120	2.1	0.4	0.28	0.36
Brampton	215	-19	-21	30	23	4100	28	119	720	820	140	1.3	0.4	0.34	0.44
Brantford	205	-18	-20	30	23	3900	23	103	780	850	160	1.3	0.4	0.33	0.42
Brighton	95	-21	-23	29	23	4000	23	94	760	850	160	1.6	0.4	0.37	0.48
Brockville	85	-23	-25	29	23	4060	25	103	770	975	180	2.2	0.4	0.34	0.44
Burk's Falls	305	-26	-28	29	22	5020	25	97	810	1010	120	2.7	0.4	0.27	0.35
Burlington	80	-17	-19	31	23	3740	23	103	770	850	160	1.1	0.4	0.36	0.46
Cambridge	295	-18	-20	29	23	4100	25	113	800	890	160	1.6	0.4	0.28	0.36
Campbellford	150	-23	-26	30	23	4280	25	97	730	850	160	1.7	0.4	0.32	0.41
Cannington	255	-24	-26	30	23	4310	25	108	740	950	120	2.2	0.4	0.28	0.36
Carleton Place	135	-25	-27	30	23	4600	25	97	730	850	160	2.5	0.4	0.32	0.41
Cavan	200	-23	-25	30	23	4400	25	97	740	850	140	2.0	0.4	0.34	0.44
Centralia	260	-17	-19	30	23	3800	25	103	820	1000	180	2.3	0.4	0.38	0.49
Chapleau	425	-35	-38	27	21	5900	20	97	530	850	80	3.6	0.4	0.23	0.30
Chatham	180	-16	-18	31	24	3470	28	103	800	850	180	1.0	0.4	0.33	0.43
Chesley	275	-19	-21	29	22	4320	28	103	810	1125	140	2.8	0.4	0.37	0.48
Column 1	2	3	4	5	6	7	8	9	10	11	12	13	14	15	16

Table 2 (Cont'd)
Climatic Design Data

Location	Elevation, m	Design Temperature				Degree Days Below 18°C	15 Min Rainfall, mm	One Day Rainfall, 1/50, mm	Annual Rainfall, mm	Annual Total Precipitation, mm	Driving Rain Wind Pressures, Pa, 1/5	Snow Load, kPa, 1/50		Hourly Wind Pressures, kPa	
		January		July 2.5%								S _s	S _r	1/10	1/50
		2.5%, °C	1%, °C	Dry, °C	Wet, °C										
Clinton	280	-17	-19	29	23	4150	25	103	810	1000	160	2.6	0.4	0.38	0.49
Coboconk	270	-25	-27	30	23	4500	25	108	740	950	120	2.5	0.4	0.27	0.35
Cobourg	90	-21	-23	29	23	3980	23	94	760	825	160	1.2	0.4	0.38	0.49
Cochrane	245	-34	-36	29	21	6200	20	92	575	875	80	2.8	0.3	0.27	0.35
Colborne	105	-21	-23	29	23	3980	23	94	760	850	160	1.6	0.4	0.38	0.49
Collingwood	190	-21	-23	29	23	4180	28	97	720	950	160	2.7	0.4	0.30	0.39
Cornwall	35	-23	-25	30	23	4250	25	103	780	960	180	2.2	0.4	0.32	0.41
Corunna	185	-16	-18	31	24	3600	25	100	760	800	180	1.0	0.4	0.36	0.47
Deep River	145	-29	-32	30	22	4900	23	92	650	850	100	2.5	0.4	0.27	0.35
Deseronto	85	-22	-24	29	23	4070	23	92	760	900	160	1.9	0.4	0.33	0.43
Dorchester	260	-18	-20	30	24	3900	28	103	850	950	180	1.9	0.4	0.36	0.47
Dorion	200	-33	-35	28	21	5950	20	103	550	725	160	2.8	0.4	0.30	0.39
Dresden	185	-16	-18	31	24	3750	28	97	760	820	180	1.0	0.4	0.33	0.43
Dryden	370	-34	-36	28	22	5850	25	97	550	700	120	2.4	0.3	0.23	0.30
Dundalk	525	-22	-24	29	22	4700	28	108	750	1080	150	3.2	0.4	0.33	0.42
Dunnville	175	-15	-17	30	24	3660	23	108	830	950	160	2.0	0.4	0.36	0.46
Durham	340	-20	-22	29	22	4340	28	103	815	1025	140	2.8	0.4	0.34	0.44
Dutton	225	-16	-18	31	24	3700	28	92	850	925	180	1.3	0.4	0.36	0.47
Earlton	245	-33	-36	29	22	5730	23	92	560	820	120	3.1	0.4	0.35	0.45
Edison	365	-34	-36	28	22	5740	25	108	510	680	120	2.4	0.3	0.24	0.31
Elliot Lake	380	-26	-28	29	21	4950	23	108	630	950	160	2.9	0.4	0.29	0.38
Elmvale	220	-24	-26	29	23	4200	28	97	720	950	140	2.6	0.4	0.28	0.36
Embro	310	-19	-21	30	23	3950	28	113	830	950	160	2.0	0.4	0.37	0.48
Englehart	205	-33	-36	29	22	5800	23	92	600	880	100	2.8	0.4	0.32	0.41
Espanola	220	-25	-27	29	21	4920	23	108	650	840	160	2.3	0.4	0.33	0.42
Exeter	265	-17	-19	30	23	3900	25	113	810	975	180	2.4	0.4	0.38	0.49
Fenelon Falls	260	-25	-27	30	23	4440	25	108	730	950	120	2.3	0.4	0.28	0.36
Fergus	400	-20	-22	29	23	4300	28	108	760	925	160	2.2	0.4	0.28	0.36
Forest	215	-16	-18	31	23	3740	25	103	810	875	160	2.0	0.4	0.37	0.48
Fort Erie	180	-15	-17	30	24	3650	23	108	860	1020	160	2.3	0.4	0.36	0.46
Fort Erie (Ridgeway)	190	-15	-17	30	24	3600	25	108	860	1000	160	2.3	0.4	0.36	0.46
Fort Frances	340	-33	-35	29	22	5440	25	108	570	725	120	2.3	0.3	0.24	0.31
Gananoque	80	-22	-24	28	23	4010	23	103	760	900	180	2.1	0.4	0.36	0.47
Geraldton	345	-36	-39	28	21	6450	20	86	550	725	100	2.9	0.4	0.23	0.30
Glencoe	215	-16	-18	31	24	3680	28	103	800	925	180	1.5	0.4	0.33	0.43
Goderich	185	-16	-18	29	23	4000	25	92	810	950	180	2.4	0.4	0.43	0.55
Column 1	2	3	4	5	6	7	8	9	10	11	12	13	14	15	16

Table 2 (Cont'd)
Climatic Design Data

Location	Elevation, m	Design Temperature				Degree Days Below 18°C	15 Min Rainfall, mm	One Day Rainfall, 1/50, mm	Annual Rainfall, mm	Annual Total Precipitation, mm	Driving Rain Wind Pressures, Pa, 1/5	Snow Load, kPa, 1/50		Hourly Wind Pressures, kPa	
		January		July 2.5%								S _s	S _r	1/10	1/50
		2.5%, °C	1%, °C	Dry, °C	Wet, °C										
Gore Bay	205	-24	-26	28	22	4700	23	92	640	860	160	2.6	0.4	0.34	0.44
Graham	495	-35	-37	29	22	5940	23	97	570	750	140	2.6	0.3	0.23	0.30
Gravenhurst (Muskoka Airport)	255	-26	-28	29	23	4760	25	103	790	1050	120	2.7	0.4	0.28	0.36
Grimsby	85	-16	-18	30	23	3520	23	108	760	875	160	0.9	0.4	0.36	0.46
Guelph	340	-19	-21	29	23	4270	28	103	770	875	140	1.9	0.4	0.28	0.36
Guthrie	280	-24	-26	29	23	4300	28	103	700	950	120	2.5	0.4	0.28	0.36
Haileybury	210	-32	-35	30	22	5600	23	92	590	820	120	2.4	0.4	0.34	0.44
Haldimand (Caledonia)	190	-18	-20	30	23	3750	23	108	810	875	160	1.2	0.4	0.34	0.44
Haldimand (Hagersville)	215	-17	-19	30	23	3760	25	97	840	875	160	1.3	0.4	0.36	0.46
Haliburton	335	-27	-29	29	23	4840	25	92	780	980	100	2.9	0.4	0.27	0.35
Halton Hills (Georgetown)	255	-19	-21	30	23	4200	28	119	750	850	140	1.4	0.4	0.29	0.37
Hamilton															
Above Escarpment - West of John C. Munro Int'l Airport	240	-17	-19	31	23	3460	23	108	810	875	160	1.5	0.4	0.36	0.46
Above Escarpment - East of John C. Munro Int'l Airport	200	-17	-19	31	23	3460	23	108	810	875	160	1.3	0.4	0.36	0.46
Below Escarpment - West of Highway 403	90	-17	-19	31	23	3460	23	108	810	875	160	1.1	0.4	0.36	0.46
Below Escarpment - East of Highway 403	90	-17	-19	31	23	3460	23	108	810	875	160	1.1	0.4	0.36	0.46
Hanover	270	-19	-21	29	22	4300	28	103	790	1050	140	2.6	0.4	0.37	0.48
Hastings	200	-24	-26	30	23	4280	25	92	730	840	140	2.0	0.4	0.32	0.41
Hawkesbury	50	-25	-27	30	23	4610	23	103	800	925	160	2.3	0.4	0.32	0.41
Hearst	245	-35	-37	29	21	6450	20	86	520	825	80	2.8	0.3	0.23	0.30
Honey Harbour	180	-24	-26	29	23	4300	25	97	710	1050	160	2.7	0.4	0.30	0.39
Hornepayne	360	-37	-40	28	21	6340	20	93	420	750	80	3.3	0.4	0.23	0.30
Huntsville	335	-26	-29	29	22	4850	25	103	800	1000	120	2.9	0.4	0.27	0.35
Ingersoll	280	-18	-20	30	23	3920	28	108	840	950	180	1.7	0.4	0.37	0.48
Iroquois Falls	275	-33	-36	29	21	6100	20	86	575	825	100	2.9	0.3	0.29	0.37
Jellicoe	330	-36	-39	28	21	6400	20	86	550	750	100	2.7	0.4	0.23	0.30
Kapuskasing	245	-34	-36	29	21	6250	20	86	550	825	100	3.0	0.3	0.24	0.31
Kemptville	90	-25	-27	30	23	4540	25	92	750	925	160	2.3	0.4	0.32	0.41
Kenora	370	-33	-35	28	22	5630	25	113	515	630	120	2.5	0.3	0.24	0.31
Killaloe	185	-28	-31	30	22	4960	23	86	680	825	120	2.7	0.4	0.27	0.35
Kincardine	190	-17	-19	28	22	3890	25	92	800	950	180	2.6	0.4	0.43	0.55
Column 1	2	3	4	5	6	7	8	9	10	11	12	13	14	15	16

Table 2 (Cont'd)
Climatic Design Data

Location	Elevation, m	Design Temperature				Degree Days Below 18°C	15 Min Rainfall, mm	One Day Rainfall, 1/50, mm	Annual Rainfall, mm	Annual Total Precipitation, mm	Driving Rain Wind Pressures, Pa, 1/5	Snow Load, kPa, 1/50		Hourly Wind Pressures, kPa	
		January		July 2.5%								S _s	S _r	1/10	1/50
		2.5%, °C	1%, °C	Dry, °C	Wet, °C										
Kingston	80	-22	-24	28	23	4000	23	108	780	950	180	2.1	0.4	0.36	0.47
Kinmount	295	-26	-28	29	23	4600	25	108	750	950	120	2.7	0.4	0.27	0.35
Kirkland Lake	325	-33	-36	29	22	6000	23	92	600	875	100	2.9	0.3	0.30	0.39
Kitchener	335	-19	-21	29	23	4200	28	119	780	925	140	2.0	0.4	0.29	0.37
Lakefield	240	-24	-26	30	23	4330	25	92	720	850	140	2.2	0.4	0.29	0.38
Lansdowne House	240	-38	-40	28	21	7150	23	92	500	680	140	3.0	0.2	0.25	0.32
Leamington	190	-15	-17	31	24	3400	28	113	800	875	180	0.8	0.4	0.36	0.47
Lindsay	265	-24	-26	30	23	4320	25	103	720	850	140	2.3	0.4	0.29	0.38
Lion's Head	185	-19	-21	27	22	4300	25	103	700	950	180	2.7	0.4	0.37	0.48
Listowel	380	-19	-21	29	23	4300	28	119	800	1000	160	2.6	0.4	0.36	0.47
London	245	-18	-20	30	24	3900	28	103	825	975	180	1.9	0.4	0.36	0.47
Lucan	300	-17	-19	30	23	3900	25	113	810	1000	180	2.3	0.4	0.39	0.50
Maitland	85	-23	-25	29	23	4080	25	103	770	975	180	2.2	0.4	0.34	0.44
Markdale	425	-20	-22	29	22	4500	28	103	820	1050	160	3.2	0.4	0.32	0.41
Markham	175	-21	-23	31	24	4000	25	86	720	825	140	1.3	0.4	0.34	0.44
Martin	485	-35	-37	29	22	5900	25	103	560	750	120	2.6	0.3	0.23	0.30
Matheson	265	-33	-36	29	21	6080	20	86	580	825	100	2.8	0.3	0.30	0.39
Mattawa	165	-29	-31	30	22	5050	23	86	700	875	100	2.1	0.4	0.25	0.32
Midland	190	-24	-26	29	23	4200	25	97	740	1060	160	2.7	0.4	0.30	0.39
Milton	200	-18	-20	30	23	3920	25	125	750	850	160	1.3	0.4	0.33	0.43
Milverton	370	-19	-21	29	23	4200	28	108	800	1050	160	2.4	0.4	0.33	0.43
Minden	270	-27	-29	29	23	4640	25	97	780	1010	100	2.7	0.4	0.27	0.35
Mississauga	160	-18	-20	30	23	3880	25	113	720	800	160	1.1	0.4	0.34	0.44
Mississauga (Lester B. Pearson International Airport)	170	-20	-22	31	24	3890	26	108	685	790	160	1.1	0.4	0.34	0.44
Mississauga (Port Credit)	75	-18	-20	29	23	3780	25	108	720	800	160	0.9	0.4	0.37	0.48
Mitchell	335	-18	-20	29	23	4100	28	113	810	1050	160	2.4	0.4	0.37	0.48
Moosonee	10	-36	-38	28	22	6800	18	81	500	700	160	2.7	0.3	0.27	0.35
Morrisburg	75	-23	-25	30	23	4370	25	103	800	950	180	2.3	0.4	0.32	0.41
Mount Forest	420	-21	-24	28	22	4700	28	103	740	940	140	2.7	0.4	0.32	0.41
Nakina	325	-36	-38	28	21	6500	20	86	540	750	100	2.8	0.4	0.23	0.30
Nanticoke (Jarvis)	205	-17	-18	30	23	3700	28	108	840	900	160	1.4	0.4	0.37	0.48
Nanticoke (Port Dover)	180	-15	-17	30	24	3600	25	108	860	950	140	1.2	0.4	0.37	0.48
Napanee	90	-22	-24	29	23	4140	23	92	770	900	160	1.9	0.4	0.33	0.43
New Liskeard	180	-32	-35	30	22	5570	23	92	570	810	100	2.6	0.4	0.33	0.43
Newcastle	115	-20	-22	30	23	3990	23	86	760	830	160	1.5	0.4	0.37	0.48
Column 1	2	3	4	5	6	7	8	9	10	11	12	13	14	15	16

Table 2 (Cont'd)
Climatic Design Data

Location	Elevation, m	Design Temperature				Degree Days Below 18°C	15 Min Rainfall, mm	One Day Rainfall, 1/50, mm	Annual Rainfall, mm	Annual Total Precipitation, mm	Driving Rain Wind Pressures, Pa, 1/5	Snow Load, kPa, 1/50		Hourly Wind Pressures, kPa	
		January		July 2.5%								S _s	S _r	1/10	1/50
		2.5%, °C	1%, °C	Dry, °C	Wet, °C										
Newcastle (Bowmanville)	95	-20	-22	30	23	4000	23	86	760	830	160	1.4	0.4	0.37	0.48
Newmarket	185	-22	-24	30	23	4260	28	108	700	800	140	2.0	0.4	0.29	0.38
Niagara Falls	210	-16	-18	30	23	3600	23	96	810	950	160	1.8	0.4	0.33	0.43
North Bay	210	-28	-30	28	22	5150	25	95	775	975	120	2.2	0.4	0.27	0.34
Norwood	225	-24	-26	30	23	4320	25	92	720	850	120	2.1	0.4	0.32	0.41
Oakville	90	-18	-20	30	23	3760	23	97	750	850	160	1.1	0.4	0.36	0.47
Orangeville	430	-21	-23	29	23	4450	28	108	730	875	140	2.3	0.4	0.28	0.36
Orillia	230	-25	-27	29	23	4260	25	103	740	1000	120	2.4	0.4	0.28	0.36
Oshawa	110	-19	-21	30	23	3860	23	86	760	875	160	1.4	0.4	0.37	0.48
Ottawa (Metropolitan)															
Ottawa (City Hall)	70	-25	-27	30	23	4440	23	86	750	900	160	2.4	0.4	0.32	0.41
Ottawa (Barrhaven)	98	-25	-27	30	23	4500	25	92	750	900	160	2.4	0.4	0.32	0.41
Ottawa (Kanata)	98	-25	-27	30	23	4520	25	92	730	900	160	2.5	0.4	0.32	0.41
Ottawa (MacDonald-Cartier Int'l Airport)	125	-25	-27	30	23	4500	24	89	750	900	160	2.4	0.4	0.32	0.41
Ottawa (Orleans)	70	-26	-28	30	23	4500	23	91	750	900	160	2.4	0.4	0.32	0.41
Owen Sound	215	-19	-21	29	22	4030	28	113	760	1075	160	2.8	0.4	0.37	0.48
Pagwa River	185	-35	-37	28	21	6500	20	86	540	825	80	2.7	0.4	0.23	0.30
Paris	245	-18	-20	30	23	4000	23	96	790	925	160	1.4	0.4	0.33	0.42
Parkhill	205	-16	-18	31	23	3800	25	103	800	925	180	2.1	0.4	0.39	0.50
Parry Sound	215	-24	-26	28	22	4640	23	97	820	1050	160	2.8	0.4	0.30	0.39
Pelham (Fonthill)	230	-15	-17	30	23	3690	23	96	820	950	160	2.1	0.4	0.33	0.42
Pembroke	125	-28	-31	30	23	4980	23	105	640	825	100	2.5	0.4	0.27	0.35
Penetanguishene	220	-24	-26	29	23	4200	25	97	720	1050	160	2.8	0.4	0.30	0.39
Perth	130	-25	-27	30	23	4540	25	92	730	900	140	2.3	0.4	0.32	0.41
Petawawa	135	-29	-31	30	23	4980	23	92	640	825	100	2.6	0.4	0.27	0.35
Peterborough	200	-23	-25	30	23	4400	25	92	710	840	140	2.0	0.4	0.32	0.41
Petrolia	195	-16	-18	31	24	3640	25	108	810	920	180	1.3	0.4	0.36	0.47
Pickering (Dunbarton)	85	-19	-21	30	23	3800	23	92	730	825	140	1.0	0.4	0.37	0.48
Picton	95	-21	-23	29	23	3980	23	92	770	940	160	2.0	0.4	0.38	0.49
Plattsville	300	-19	-21	29	23	4150	28	103	820	950	140	1.9	0.4	0.33	0.42
Point Alexander	150	-29	-32	30	22	4960	23	92	650	850	100	2.5	0.4	0.27	0.35
Port Burwell	195	-15	-17	30	24	3800	25	92	930	1000	180	1.2	0.4	0.36	0.47
Port Colborne	180	-15	-17	30	24	3600	23	108	850	1000	160	2.1	0.4	0.36	0.46
Port Elgin	205	-17	-19	28	22	4100	25	92	790	850	180	2.8	0.4	0.43	0.55
Port Hope	100	-21	-23	29	23	3970	23	94	760	825	180	1.2	0.4	0.37	0.48
Column 1	2	3	4	5	6	7	8	9	10	11	12	13	14	15	16

Table 2 (Cont'd)
Climatic Design Data

Location	Elevation, m	Design Temperature				Degree Days Below 18°C	15 Min Rainfall, mm	One Day Rainfall, 1/50, mm	Annual Rainfall, mm	Annual Total Precipitation, mm	Driving Rain Wind Pressures, Pa, 1/5	Snow Load, kPa, 1/50		Hourly Wind Pressures, kPa	
		January		July 2.5%								S _s	S _r	1/10	1/50
		2.5%, °C	1%, °C	Dry, °C	Wet, °C										
Port Perry	270	-22	-24	30	23	4260	25	97	720	850	140	2.4	0.4	0.34	0.44
Port Stanley	180	-15	-17	31	24	3850	25	92	940	975	180	1.2	0.4	0.36	0.47
Prescott	90	-23	-25	29	23	4120	25	103	770	975	180	2.2	0.4	0.34	0.44
Princeton	280	-18	-20	30	23	4000	25	97	810	925	160	1.5	0.4	0.33	0.42
Raith	475	-34	-37	28	22	5900	23	97	570	750	120	2.7	0.4	0.23	0.30
Rayside-Balfour (Chelmsford)	270	-28	-30	29	21	5200	25	92	650	850	180	2.5	0.4	0.35	0.45
Red Lake	360	-35	-37	28	21	6220	20	92	470	630	120	2.6	0.3	0.23	0.30
Renfrew	115	-27	-30	30	23	4900	23	97	620	810	140	2.5	0.4	0.27	0.35
Richmond Hill	230	-21	-23	31	24	4000	25	97	740	850	140	1.5	0.4	0.34	0.44
Rockland	50	-26	-28	30	23	4600	23	92	780	950	160	2.4	0.4	0.31	0.40
Sarnia	190	-16	-18	31	24	3750	25	100	750	825	180	1.1	0.4	0.36	0.47
Sault Ste. Marie	190	-25	-28	29	22	4960	23	97	660	950	200	3.1	0.4	0.34	0.44
Schreiber	310	-34	-36	27	21	5960	20	103	600	850	160	3.3	0.4	0.30	0.39
Seaforth	310	-17	-19	30	23	4100	25	108	810	1025	160	2.5	0.4	0.37	0.48
Shelburne	495	-22	-24	29	23	4700	28	108	740	900	150	3.1	0.4	0.31	0.40
Simcoe	210	-17	-19	30	24	3700	28	113	860	950	160	1.3	0.4	0.35	0.45
Sioux Lookout	375	-34	-36	28	22	5950	25	97	520	710	100	2.6	0.3	0.23	0.30
Smiths Falls	130	-25	-27	30	23	4540	25	92	730	850	140	2.3	0.4	0.32	0.41
Smithville	185	-16	-18	30	23	3650	23	108	800	900	160	1.5	0.4	0.33	0.42
Smooth Rock Falls	235	-34	-36	29	21	6250	20	92	560	850	80	2.7	0.3	0.25	0.32
South River	355	-27	-29	29	22	5090	25	103	830	975	120	2.8	0.4	0.27	0.35
Southampton	180	-17	-19	28	22	4100	25	92	800	830	180	2.7	0.4	0.41	0.53
St. Catharines	105	-16	-18	30	23	3540	23	92	770	850	160	1.0	0.4	0.36	0.46
St. Mary's	310	-18	-20	30	23	4000	28	108	820	1025	160	2.2	0.4	0.36	0.47
St. Thomas	225	-16	-18	31	24	3780	25	103	900	975	180	1.4	0.4	0.36	0.47
Stirling	120	-23	-25	30	23	4220	25	97	740	850	120	1.7	0.4	0.31	0.40
Stratford	360	-18	-20	29	23	4050	28	113	820	1050	160	2.3	0.4	0.35	0.45
Strathroy	225	-17	-19	31	24	3780	25	103	770	950	180	1.9	0.4	0.36	0.47
Sturgeon Falls	205	-28	-30	29	21	5200	25	95	700	910	140	2.4	0.4	0.27	0.35
Sudbury	275	-28	-30	29	21	5180	25	97	650	875	200	2.5	0.4	0.36	0.46
Sundridge	340	-27	-29	29	22	5080	25	97	840	975	120	2.8	0.4	0.27	0.35
Tavistock	340	-19	-21	29	23	4100	28	113	820	1010	160	2.1	0.4	0.35	0.45
Temagami	300	-30	-33	30	22	5420	23	92	650	875	120	2.6	0.4	0.29	0.37
Thamesford	280	-19	-21	30	23	3950	28	108	820	975	160	1.9	0.4	0.37	0.48
Column 1	2	3	4	5	6	7	8	9	10	11	12	13	14	15	16

Table 2 (Cont'd)
Climatic Design Data

Location	Elevation, m	Design Temperature				Degree Days Below 18°C	15 Min Rainfall, mm	One Day Rainfall, 1/50, mm	Annual Rainfall, mm	Annual Total Precipitation, mm	Driving Rain Wind Pressures, Pa, 1/5	Snow Load, kPa, 1/50		Hourly Wind Pressures, kPa	
		January		July 2.5%								S _s	S _r	1/10	1/50
		2.5%, °C	1%, °C	Dry, °C	Wet, °C										
Theftford	205	-16	-18	31	23	3710	25	103	810	900	180	2.1	0.4	0.39	0.50
Thunder Bay	210	-31	-33	29	21	5650	23	108	560	710	160	2.9	0.4	0.30	0.39
Tillsonburg	215	-17	-19	30	24	3840	25	103	880	980	160	1.3	0.4	0.34	0.44
Timmins	300	-34	-36	29	21	5940	20	108	560	875	100	3.1	0.3	0.27	0.35
Timmins (Porcupine)	295	-34	-36	29	21	6000	20	103	560	875	100	2.9	0.3	0.29	0.37
Toronto Metropolitan Region															
Etobicoke	160	-20	-22	31	24	3800	26	108	720	800	160	1.1	0.4	0.34	0.44
North York	175	-20	-22	31	24	3760	25	108	730	850	150	1.2	0.4	0.34	0.44
Scarborough	180	-20	-22	31	24	3800	25	92	730	825	160	1.2	0.4	0.36	0.47
Toronto (City Hall)	90	-18	-20	31	23	3520	25	97	720	820	160	0.9	0.4	0.34	0.44
Trenton	80	-22	-24	29	23	4110	23	97	760	850	160	1.6	0.4	0.36	0.47
Trout Creek	330	-27	-29	29	22	5100	25	103	780	975	120	2.7	0.4	0.27	0.35
Uxbridge	275	-22	-24	30	23	4240	25	103	700	850	140	2.4	0.4	0.33	0.42
Vaughan (Woodbridge)	165	-20	-22	31	24	4100	26	113	700	800	140	1.1	0.4	0.34	0.44
Vittoria	215	-15	-17	30	24	3680	25	113	880	950	160	1.3	0.4	0.36	0.47
Walkerton	275	-18	-20	30	22	4300	28	103	790	1025	160	2.7	0.4	0.39	0.50
Wallaceburg	180	-16	-18	31	24	3600	28	97	760	825	180	0.9	0.4	0.35	0.45
Waterloo	330	-19	-21	29	23	4200	28	119	780	925	160	2.0	0.4	0.29	0.37
Watford	240	-17	-19	31	24	3740	25	108	790	950	160	1.9	0.4	0.36	0.47
Wawa	290	-34	-36	26	21	5840	20	93	725	950	160	3.4	0.4	0.30	0.39
Welland	180	-15	-17	30	23	3670	23	103	840	975	160	2.0	0.4	0.33	0.43
West Lorne	215	-16	-18	31	24	3700	28	103	840	900	180	1.3	0.4	0.36	0.47
Whitby	85	-20	-22	30	23	3820	23	86	760	850	160	1.2	0.4	0.37	0.48
Whitby (Brooklin)	160	-20	-22	30	23	4010	23	86	770	850	140	1.9	0.4	0.35	0.45
White River	375	-39	-42	28	21	6150	20	92	575	825	100	3.6	0.4	0.23	0.30
Warton	185	-19	-21	29	22	4300	25	103	740	1000	180	2.7	0.4	0.37	0.48
Windsor	185	-16	-18	32	24	3400	28	103	800	900	180	0.8	0.4	0.36	0.47
Wingham	310	-18	-20	30	23	4220	28	108	780	1050	160	2.6	0.4	0.39	0.50
Woodstock	300	-19	-21	30	23	3910	28	113	830	930	160	1.9	0.4	0.34	0.44
Wyoming	215	-16	-18	31	24	3700	25	103	815	900	180	1.6	0.4	0.36	0.47
Column 1	2	3	4	5	6	7	8	9	10	11	12	13	14	15	16

Table 3
Seismic Data

Location	Seismic Data							PGA	PGV
	S _a (0.2)	S _a (0.5)	S _a (1.0)	S _a (2.0)	S _a (5.0)	S _a (10.0)			
Ailsa Craig	0.095	0.064	0.039	0.020	0.0049	0.0021	0.056	0.050	
Ajax	0.210	0.114	0.060	0.029	0.0071	0.0028	0.134	0.091	
Alexandria	0.589	0.309	0.148	0.068	0.0180	0.0062	0.376	0.255	
Alliston	0.111	0.076	0.046	0.024	0.0059	0.0025	0.066	0.060	
Almonte	0.337	0.188	0.098	0.048	0.0130	0.0049	0.215	0.157	
Armstrong	0.064	0.037	0.019	0.0081	0.0018	0.0008	0.038	0.025	
Arnprior	0.371	0.201	0.102	0.0490	0.0130	0.0049	0.238	0.168	
Atikokan	0.069	0.038	0.018	0.0072	0.0015	0.0007	0.041	0.025	
Attawapiskat	0.074	0.043	0.022	0.0092	0.0019	0.0010	0.045	0.030	
Aurora	0.138	0.087	0.050	0.0260	0.0064	0.0027	0.085	0.068	
Bancroft	0.151	0.105	0.063	0.0320	0.0084	0.0035	0.090	0.085	
Barrie	0.108	0.077	0.047	0.0250	0.0061	0.0025	0.063	0.060	
Barriefield	0.162	0.110	0.066	0.0340	0.0089	0.0038	0.098	0.091	
Beaverton	0.117	0.082	0.050	0.0260	0.0065	0.0028	0.069	0.064	
Belleville	0.162	0.105	0.061	0.0310	0.0080	0.0034	0.100	0.087	
Belmont	0.116	0.073	0.042	0.0210	0.0053	0.0021	0.070	0.056	
Big Trout Lake (Kitchenuhmaykoosib)	0.054	0.033	0.017	0.0072	0.0015	0.0008	0.032	0.023	
CFB Borden	0.107	0.075	0.046	0.0240	0.0059	0.0025	0.063	0.059	
Bracebridge	0.116	0.084	0.051	0.0270	0.0068	0.0028	0.068	0.067	
Bradford	0.123	0.081	0.048	0.0250	0.0062	0.0027	0.074	0.063	
Brampton	0.168	0.096	0.052	0.0260	0.0064	0.0025	0.106	0.074	
Brantford	0.155	0.089	0.049	0.0240	0.0059	0.0024	0.097	0.068	
Brighton	0.173	0.106	0.060	0.0300	0.0076	0.0032	0.108	0.087	
Brockville	0.259	0.157	0.086	0.0430	0.0110	0.0046	0.164	0.131	
Burk's Falls	0.143	0.096	0.057	0.0290	0.0074	0.0031	0.086	0.076	
Burlington	0.266	0.131	0.062	0.0290	0.0068	0.0027	0.172	0.102	
Cambridge	0.141	0.084	0.047	0.0240	0.0058	0.0024	0.088	0.066	
Campbellford	0.144	0.097	0.058	0.0300	0.0076	0.0032	0.088	0.078	
Cannington	0.122	0.084	0.051	0.0270	0.0067	0.0028	0.073	0.067	
Carleton Place	0.302	0.175	0.093	0.0460	0.0120	0.0048	0.192	0.146	
Cavan	0.140	0.092	0.055	0.0280	0.0071	0.0030	0.086	0.074	
Centralia	0.092	0.064	0.039	0.0200	0.0050	0.0021	0.054	0.050	
Chapleau	0.071	0.050	0.031	0.0160	0.0037	0.0017	0.041	0.039	
Chatham	0.112	0.070	0.039	0.0190	0.0047	0.0020	0.068	0.054	
Chesley	0.083	0.062	0.040	0.0210	0.0052	0.0022	0.047	0.050	
Column 1	2	3	4	5	6	7	8	9	

Table 3 (Cont'd)
Seismic Data

Location	Seismic Data							PGA	PGV
	S _a (0.2)	S _a (0.5)	S _a (1.0)	S _a (2.0)	S _a (5.0)	S _a (10.0)			
Clinton	0.084	0.061	0.038	0.0200	0.0049	0.0021	0.048	0.048	
Coboconk	0.120	0.086	0.052	0.0270	0.0070	0.0030	0.070	0.068	
Cobourg	0.179	0.106	0.059	0.0300	0.0074	0.0031	0.113	0.086	
Cochrane	0.222	0.107	0.052	0.0240	0.0058	0.0022	0.145	0.083	
Colborne	0.176	0.106	0.060	0.0300	0.0076	0.0031	0.111	0.087	
Collingwood	0.096	0.070	0.044	0.0230	0.0058	0.0024	0.055	0.056	
Cornwall	0.587	0.307	0.147	0.0670	0.0170	0.0060	0.375	0.254	
Corunna	0.087	0.060	0.036	0.0180	0.0046	0.0020	0.050	0.047	
Deep River	0.389	0.208	0.104	0.0490	0.0130	0.0048	0.250	0.172	
Deseronto	0.158	0.106	0.062	0.0320	0.0081	0.0035	0.096	0.087	
Dorchester	0.112	0.072	0.042	0.0210	0.0052	0.0021	0.067	0.056	
Dorion	0.059	0.035	0.018	0.0076	0.0016	0.0008	0.035	0.024	
Dresden	0.104	0.067	0.039	0.0190	0.0047	0.0020	0.062	0.051	
Dryden	0.072	0.040	0.019	0.0076	0.0016	0.0008	0.043	0.027	
Dundalk	0.097	0.069	0.043	0.0220	0.0056	0.0024	0.057	0.055	
Dunnville	0.232	0.120	0.059	0.0280	0.0067	0.0027	0.149	0.093	
Durham	0.088	0.065	0.041	0.0210	0.0053	0.0022	0.051	0.051	
Dutton	0.116	0.072	0.041	0.0210	0.0050	0.0021	0.071	0.056	
Earlton	0.182	0.108	0.059	0.0290	0.0074	0.0030	0.114	0.086	
Edison	0.070	0.039	0.019	0.0075	0.0016	0.0008	0.042	0.027	
Elliot Lake	0.074	0.054	0.035	0.0180	0.0046	0.0020	0.043	0.043	
Elmvale	0.101	0.074	0.046	0.0240	0.0061	0.0025	0.059	0.059	
Embro	0.111	0.072	0.042	0.0220	0.0053	0.0022	0.067	0.056	
Englehart	0.175	0.104	0.057	0.0290	0.0073	0.0030	0.109	0.083	
Espanola	0.086	0.063	0.039	0.0210	0.0052	0.0021	0.050	0.050	
Exeter	0.090	0.063	0.039	0.0200	0.0049	0.0021	0.052	0.050	
Fenelon Falls	0.121	0.086	0.052	0.0270	0.0068	0.0030	0.072	0.068	
Fergus	0.115	0.075	0.045	0.0230	0.0056	0.0024	0.069	0.059	
Forest	0.087	0.061	0.037	0.0190	0.0047	0.0020	0.051	0.047	
Fort Erie	0.312	0.152	0.070	0.0320	0.0074	0.0028	0.202	0.117	
Fort Erie (Ridgeway)	0.307	0.149	0.069	0.0310	0.0073	0.0028	0.198	0.115	
Fort Frances	0.064	0.035	0.017	0.0069	0.0015	0.0007	0.039	0.024	
Gananoque	0.180	0.119	0.070	0.0360	0.0095	0.0039	0.110	0.099	
Geraldton	0.057	0.036	0.019	0.0082	0.0018	0.0010	0.033	0.024	
Glencoe	0.107	0.068	0.040	0.0200	0.0049	0.0021	0.064	0.054	
Column 1	2	3	4	5	6	7	8	9	

Table 3 (Cont'd)
Seismic Data

Location	Seismic Data							PGA	PGV
	S _a (0.2)	S _a (0.5)	S _a (1.0)	S _a (2.0)	S _a (5.0)	S _a (10.0)			
Goderich	0.079	0.059	0.037	0.0190	0.0049	0.0020	0.045	0.047	
Gore Bay	0.071	0.055	0.035	0.0180	0.0047	0.0020	0.040	0.044	
Graham	0.071	0.039	0.020	0.0079	0.0016	0.0008	0.043	0.027	
Gravenhurst (Muskoka Airport)	0.112	0.082	0.050	0.0260	0.0067	0.0028	0.065	0.064	
Grimsby	0.301	0.146	0.068	0.0300	0.0073	0.0028	0.195	0.113	
Guelph	0.133	0.082	0.047	0.0240	0.0058	0.0024	0.082	0.063	
Guthrie	0.109	0.078	0.048	0.0250	0.0062	0.0027	0.064	0.062	
Haileybury	0.219	0.127	0.067	0.0330	0.0083	0.0034	0.138	0.101	
Haldimand (Caledonia)	0.215	0.112	0.056	0.0270	0.0064	0.0025	0.138	0.087	
Haldimand (Hagersville)	0.172	0.096	0.051	0.0250	0.0061	0.0024	0.108	0.074	
Haliburton	0.133	0.095	0.057	0.0300	0.0077	0.0032	0.079	0.076	
Halton Hills (Georgetown)	0.155	0.090	0.050	0.0250	0.0062	0.0025	0.097	0.070	
Hamilton	0.260	0.128	0.061	0.0280	0.0068	0.0027	0.168	0.101	
Hanover	0.085	0.063	0.040	0.0210	0.0052	0.0022	0.049	0.050	
Hastings	0.141	0.096	0.057	0.029	0.0074	0.0031	0.085	0.076	
Hawkesbury	0.506	0.268	0.131	0.0620	0.0160	0.0058	0.326	0.224	
Hearst	0.073	0.048	0.028	0.0130	0.0031	0.0014	0.043	0.035	
Honey Harbour	0.103	0.076	0.047	0.0250	0.0062	0.0027	0.060	0.060	
Hornepayne	0.063	0.043	0.025	0.0120	0.0028	0.0014	0.037	0.031	
Huntsville	0.129	0.091	0.054	0.0280	0.0071	0.0031	0.077	0.072	
Ingersoll	0.116	0.073	0.043	0.0220	0.0053	0.0022	0.070	0.058	
Iroquois Falls	0.196	0.101	0.052	0.0250	0.0061	0.0024	0.127	0.079	
Jellicoe	0.057	0.035	0.019	0.0081	0.0018	0.0010	0.033	0.024	
Kapuskasing	0.112	0.064	0.035	0.0170	0.0040	0.0017	0.070	0.048	
Kemptville	0.429	0.229	0.114	0.0540	0.0140	0.0052	0.275	0.189	
Kenora	0.064	0.036	0.018	0.0072	0.0015	0.0007	0.038	0.024	
Killaloe	0.264	0.154	0.083	0.0410	0.0110	0.0044	0.168	0.127	
Kincardine	0.076	0.058	0.037	0.0190	0.0049	0.0021	0.043	0.046	
Kingston	0.161	0.110	0.065	0.0340	0.0089	0.0038	0.098	0.091	
Kinmount	0.123	0.089	0.054	0.0280	0.0071	0.0031	0.072	0.071	
Kirkland Lake	0.159	0.095	0.053	0.0270	0.0067	0.0028	0.099	0.076	
Kitchener	0.122	0.077	0.045	0.0230	0.0056	0.0024	0.074	0.060	
Lakefield	0.130	0.091	0.055	0.0280	0.0073	0.0031	0.078	0.072	
Lansdowne House	0.056	0.035	0.019	0.0078	0.0016	0.0008	0.033	0.024	
Leamington	0.114	0.070	0.038	0.0180	0.0044	0.0018	0.069	0.052	
Column 1	2	3	4	5	6	7	8	9	

Table 3 (Cont'd)
Seismic Data

Location	Seismic Data							PGA	PGV
	S _a (0.2)	S _a (0.5)	S _a (1.0)	S _a (2.0)	S _a (5.0)	S _a (10.0)			
Lindsay	0.126	0.087	0.052	0.0270	0.0068	0.0030	0.076	0.068	
Lion's Head	0.080	0.062	0.040	0.0210	0.0052	0.0022	0.045	0.050	
Listowel	0.093	0.066	0.041	0.0210	0.0052	0.0022	0.054	0.052	
London	0.108	0.070	0.041	0.0210	0.0052	0.0021	0.064	0.055	
Lucan	0.097	0.065	0.039	0.0200	0.0050	0.0021	0.057	0.051	
Maitland	0.282	0.167	0.090	0.0450	0.0120	0.0046	0.179	0.140	
Markdale	0.089	0.066	0.042	0.0220	0.0055	0.0022	0.052	0.052	
Markham	0.182	0.103	0.056	0.0280	0.0068	0.0028	0.115	0.080	
Martin	0.072	0.039	0.019	0.0075	0.0015	0.0008	0.043	0.027	
Matheson	0.160	0.091	0.050	0.0250	0.0062	0.0025	0.101	0.072	
Mattawa	0.446	0.237	0.114	0.0520	0.0130	0.0046	0.285	0.191	
Midland	0.101	0.075	0.046	0.0240	0.0061	0.0025	0.058	0.059	
Milton	0.191	0.103	0.054	0.0260	0.0064	0.0025	0.122	0.080	
Milverton	0.098	0.067	0.041	0.0210	0.0053	0.0022	0.058	0.052	
Minden	0.124	0.089	0.054	0.0280	0.0071	0.0031	0.073	0.071	
Mississauga	0.219	0.115	0.058	0.0280	0.0068	0.0027	0.141	0.090	
Mississauga (Lester B. Pearson International Airport)	0.193	0.105	0.056	0.0270	0.0067	0.0027	0.123	0.082	
Mississauga (Port Credit)	0.247	0.125	0.062	0.0290	0.0070	0.0027	0.159	0.098	
Mitchell	0.093	0.065	0.040	0.0210	0.0052	0.0021	0.054	0.051	
Moosonee	0.081	0.051	0.029	0.0140	0.0033	0.0015	0.049	0.038	
Morrisburg	0.558	0.287	0.135	0.0620	0.0160	0.0056	0.358	0.236	
Mount Forest	0.093	0.067	0.041	0.0220	0.0053	0.0022	0.054	0.052	
Nakina	0.057	0.036	0.019	0.0082	0.0018	0.0010	0.033	0.024	
Nanticoke (Jarvis)	0.156	0.090	0.049	0.0240	0.0059	0.0024	0.098	0.068	
Nanticoke (Port Dover)	0.144	0.085	0.047	0.0230	0.0058	0.0024	0.089	0.066	
Napanee	0.156	0.106	0.063	0.0330	0.0084	0.0037	0.095	0.087	
New Liskeard	0.209	0.122	0.065	0.0320	0.0081	0.0032	0.132	0.097	
Newcastle	0.186	0.107	0.058	0.0290	0.0071	0.0030	0.118	0.086	
Newcastle (Bowmanville)	0.188	0.107	0.058	0.0290	0.0071	0.0030	0.119	0.086	
Newmarket	0.132	0.085	0.050	0.0260	0.0064	0.0027	0.081	0.067	
Niagara Falls	0.321	0.157	0.072	0.0320	0.0076	0.0030	0.207	0.121	
North Bay	0.247	0.145	0.076	0.0370	0.0095	0.0037	0.155	0.114	
Norwood	0.136	0.094	0.057	0.0290	0.0074	0.0031	0.082	0.075	
Oakville	0.260	0.129	0.062	0.0290	0.0070	0.0027	0.167	0.101	
Orangeville	0.115	0.076	0.046	0.0230	0.0058	0.0024	0.069	0.059	
Column 1	2	3	4	5	6	7	8	9	

Table 3 (Cont'd)
Seismic Data

Location	Seismic Data							
	S _a (0.2)	S _a (0.5)	S _a (1.0)	S _a (2.0)	S _a (5.0)	S _a (10.0)	PGA	PGV
Orillia	0.109	0.079	0.049	0.0260	0.0064	0.0027	0.064	0.063
Oshawa	0.192	0.108	0.058	0.0290	0.0071	0.0030	0.122	0.086
Ottawa (Metropolitan)								
Ottawa (City Hall)	0.439	0.237	0.118	0.0560	0.0150	0.0055	0.281	0.196
Ottawa (Barrhaven)	0.427	0.230	0.115	0.0550	0.0150	0.0053	0.273	0.191
Ottawa (Kanata)	0.401	0.218	0.110	0.0530	0.0140	0.0052	0.257	0.181
Ottawa (MacDonald-Cartier International Airport)	0.446	0.240	0.119	0.0560	0.0150	0.0055	0.285	0.199
Ottawa (Orleans)	0.474	0.252	0.124	0.0580	0.0150	0.0056	0.304	0.208
Owen Sound	0.083	0.064	0.041	0.0210	0.0053	0.0022	0.048	0.051
Pagwa River	0.060	0.040	0.023	0.0110	0.0024	0.0013	0.035	0.028
Paris	0.141	0.084	0.047	0.0230	0.0058	0.0024	0.088	0.066
Parkhill	0.092	0.063	0.038	0.0200	0.0049	0.0020	0.054	0.050
Parry Sound	0.110	0.079	0.048	0.0250	0.0064	0.0027	0.064	0.063
Pelham (Fonthill)	0.311	0.152	0.070	0.0310	0.0074	0.0028	0.201	0.117
Pembroke	0.379	0.203	0.101	0.0490	0.0130	0.0048	0.243	0.168
Penetanguishene	0.101	0.074	0.046	0.0240	0.0061	0.0025	0.058	0.059
Perth	0.225	0.142	0.080	0.0410	0.0110	0.0045	0.140	0.119
Petawawa	0.379	0.202	0.101	0.0480	0.0130	0.0048	0.243	0.166
Peterborough	0.135	0.092	0.055	0.0280	0.0071	0.0031	0.082	0.072
Petrolia	0.092	0.062	0.037	0.0190	0.0047	0.0020	0.054	0.048
Pickering (Dunbarton)	0.219	0.117	0.060	0.0290	0.0071	0.0028	0.140	0.094
Picton	0.159	0.104	0.061	0.0310	0.0078	0.0032	0.098	0.086
Plattsville	0.119	0.075	0.044	0.0220	0.0055	0.0022	0.072	0.059
Point Alexander	0.391	0.209	0.104	0.0490	0.0130	0.0048	0.251	0.172
Port Burwell	0.132	0.079	0.044	0.0220	0.0055	0.0022	0.081	0.062
Port Colborne	0.298	0.146	0.068	0.0310	0.0073	0.0028	0.192	0.113
Port Elgin	0.077	0.060	0.038	0.0200	0.0050	0.0021	0.044	0.048
Port Hope	0.181	0.106	0.059	0.0290	0.0073	0.0030	0.114	0.086
Port Perry	0.144	0.091	0.053	0.0270	0.0067	0.0028	0.089	0.071
Port Stanley	0.123	0.075	0.043	0.0210	0.0052	0.0021	0.075	0.058
Prescott	0.350	0.195	0.101	0.0490	0.0130	0.0049	0.224	0.162
Princeton	0.129	0.079	0.045	0.0230	0.0056	0.0022	0.079	0.062
Raith	0.067	0.038	0.019	0.0078	0.0016	0.0008	0.040	0.025
Rayside-Balfour (Chelmsford)	0.104	0.072	0.044	0.0230	0.0058	0.0024	0.061	0.056
Red Lake	0.068	0.038	0.019	0.0076	0.0016	0.0008	0.041	0.025
Renfrew	0.352	0.191	0.097	0.0470	0.0130	0.0048	0.226	0.160
Column 1	2	3	4	5	6	7	8	9

Table 3 (Cont'd)
Seismic Data

Location	Seismic Data							PGA	PGV
	S _a (0.2)	S _a (0.5)	S _a (1.0)	S _a (2.0)	S _a (5.0)	S _a (10.0)			
Richmond Hill	0.163	0.095	0.053	0.0270	0.0065	0.0027	0.102	0.074	
Rockland	0.510	0.266	0.129	0.0600	0.0160	0.0056	0.328	0.221	
Samia	0.085	0.059	0.036	0.0180	0.0046	0.0020	0.049	0.046	
Sault Ste. Marie	0.062	0.044	0.028	0.0140	0.0033	0.0015	0.036	0.034	
Schreiber	0.057	0.035	0.019	0.0079	0.0018	0.0010	0.033	0.024	
Seaforth	0.087	0.062	0.039	0.0200	0.0050	0.0021	0.050	0.048	
Shelburne	0.104	0.072	0.044	0.0230	0.0058	0.0024	0.062	0.056	
Simcoe	0.141	0.084	0.047	0.0230	0.0058	0.0024	0.087	0.064	
Sioux Lookout	0.073	0.040	0.020	0.0078	0.0016	0.0008	0.044	0.028	
Smiths Falls	0.256	0.156	0.086	0.0440	0.0120	0.0046	0.161	0.131	
Smithville	0.296	0.144	0.067	0.0300	0.0071	0.0027	0.191	0.111	
Smooth Rock Falls	0.200	0.098	0.047	0.0210	0.0050	0.0020	0.130	0.074	
South River	0.164	0.106	0.061	0.0310	0.0080	0.0034	0.100	0.085	
Southampton	0.077	0.060	0.038	0.0200	0.0050	0.0021	0.044	0.048	
St. Catharines	0.319	0.155	0.071	0.0320	0.0076	0.0028	0.206	0.121	
St. Mary's	0.101	0.068	0.041	0.0210	0.0052	0.0021	0.060	0.052	
St. Thomas	0.117	0.073	0.042	0.0210	0.0052	0.0021	0.071	0.056	
Stirling	0.149	0.100	0.060	0.0310	0.0078	0.0034	0.091	0.082	
Stratford	0.103	0.069	0.041	0.0210	0.0053	0.0022	0.061	0.054	
Strathroy	0.100	0.066	0.039	0.0200	0.0049	0.0021	0.059	0.051	
Sturgeon Falls	0.183	0.113	0.062	0.0310	0.0080	0.0032	0.113	0.089	
Sudbury	0.110	0.076	0.046	0.0240	0.0059	0.0025	0.065	0.059	
Sundridge	0.157	0.103	0.059	0.0300	0.0078	0.0032	0.095	0.082	
Tavistock	0.108	0.071	0.042	0.0220	0.0053	0.0022	0.065	0.055	
Temagami	0.239	0.138	0.072	0.0350	0.0089	0.0035	0.151	0.109	
Thamesford	0.111	0.071	0.042	0.0210	0.0053	0.0022	0.066	0.056	
Theford	0.089	0.062	0.038	0.0190	0.0047	0.0020	0.052	0.048	
Thunder Bay	0.061	0.035	0.018	0.0075	0.0016	0.0008	0.036	0.024	
Tillsonburg	0.126	0.077	0.044	0.0220	0.0055	0.0022	0.076	0.060	
Timmins	0.125	0.075	0.043	0.0210	0.0053	0.0022	0.078	0.058	
Timmins (Porcupine)	0.140	0.081	0.045	0.0220	0.0055	0.0022	0.088	0.063	
Toronto Metropolitan Region									
Etobicoke	0.193	0.106	0.056	0.0270	0.0067	0.0027	0.124	0.082	
North York	0.195	0.107	0.056	0.0280	0.0067	0.0027	0.125	0.083	
Scarborough	0.219	0.116	0.060	0.0290	0.0070	0.0028	0.140	0.093	
Toronto (City Hall)	0.249	0.126	0.063	0.0290	0.0071	0.0028	0.160	0.099	
Column 1	2	3	4	5	6	7	8	9	

Table 3 (Cont'd)
Seismic Data

Location	Seismic Data							
	S _a (0.2)	S _a (0.5)	S _a (1.0)	S _a (2.0)	S _a (5.0)	S _a (10.0)	PGA	PGV
Trenton	0.167	0.105	0.060	0.0300	0.0077	0.0032	0.104	0.086
Trout Creek	0.186	0.116	0.065	0.0330	0.0084	0.0035	0.115	0.093
Uxbridge	0.139	0.089	0.052	0.0270	0.0067	0.0028	0.086	0.070
Vaughan (Woodbridge)	0.167	0.096	0.053	0.0260	0.0065	0.0027	0.105	0.074
Vittoria	0.139	0.083	0.046	0.0230	0.0056	0.0024	0.086	0.064
Walkerton	0.083	0.062	0.039	0.0210	0.0052	0.0021	0.048	0.050
Wallaceburg	0.098	0.064	0.037	0.0180	0.0044	0.0018	0.058	0.048
Waterloo	0.118	0.075	0.044	0.0230	0.0056	0.0022	0.072	0.059
Watford	0.095	0.064	0.038	0.0190	0.0049	0.0020	0.056	0.050
Wawa	0.062	0.043	0.026	0.0130	0.0030	0.0014	0.036	0.031
Welland	0.308	0.150	0.069	0.0310	0.0074	0.0028	0.199	0.115
West Lorne	0.118	0.072	0.041	0.0210	0.0050	0.0021	0.072	0.056
Whitby	0.203	0.112	0.059	0.0290	0.0071	0.0028	0.130	0.089
Whitby (Brooklin)	0.176	0.102	0.056	0.0280	0.0070	0.0028	0.111	0.080
White River	0.060	0.041	0.024	0.0110	0.0025	0.0013	0.035	0.030
Warton	0.080	0.062	0.040	0.0210	0.0052	0.0022	0.046	0.050
Windsor	0.096	0.063	0.035	0.0170	0.0041	0.0017	0.057	0.048
Wingham	0.083	0.061	0.039	0.0200	0.0050	0.0021	0.048	0.048
Woodstock	0.118	0.075	0.043	0.0220	0.0055	0.0022	0.071	0.058
Wyoming	0.090	0.061	0.037	0.0190	0.0047	0.0020	0.053	0.048
Column 1	2	3	4	5	6	7	8	9

MMAH Supplementary Standard SB-2

Fire Performance Ratings

January 15, 2019 update

COMMENCEMENT

MMAH Supplementary Standard SB-2 comes into force on the 1st day of January, 2014.

r5 SB-2 as amended by Ontario Regulation 191/14 comes into force on the 1st day of January, 2015.

r11.1 SB-2 as amended by Ontario Regulation 88/19 comes into force on the 1st day of January, 2020.

© Copyright

© Copyright Queen's Printer for Ontario 2019

All rights reserved.

Questions regarding copyright, including reproduction and distribution, may be directed to the Director,
Building and Development Branch of the Ministry of Municipal Affairs and Housing.

SB-2 Fire-Performance Ratings

Section 1 General

This Supplementary Standard is based in large measure on Appendix D of the model National Building Code of Canada 2015. The content of Appendix D was prepared on the recommendations of the Standing Committee on Fire Performance Ratings, which was established by the Canadian Commission on Building and Fire Codes (CCBFC) for this purpose.

1.1. Introduction

1.1.1. Scope

- (1) This fire-performance information is presented in a form closely linked to the performance requirements and the minimum materials specifications of the 2012 Building Code.
- (2) The ratings have been assigned only after careful consideration of all available literature on assemblies of common building materials, where they are adequately identified by description. The assigned values based on this information will, in most instances, be conservative when compared to the ratings determined on the basis of actual tests on individual assemblies.
- (3) The fire-performance information set out in this Supplementary Standard applies to materials and assemblies of materials which comply in all essential details with the minimum structural design standards described in Part 4 of Division B in the 2012 Building Code. Additional requirements, where appropriate, are described in other Sections of this Supplementary Standard.
- (4) Section 2 of this Supplementary Standard assigns fire-resistance ratings for walls, floors, roofs, columns and beams related to CAN/ULC-S101, "Fire Endurance Tests of Building Construction and Materials", and describes methods for determining these ratings.
- (5) Section 3 assigns flame-spread ratings and smoke developed classifications for surface materials related to CAN/ULC-S102, "Test for Surface Burning Characteristics of Building Materials and Assemblies" and CAN/ULC-S102.2, "Test for Surface Burning Characteristics of Flooring, Floor Coverings, and Miscellaneous Materials and Assemblies".
- (6) Section 4 describes noncombustibility in building materials when tested in accordance with CAN/ULC-S114, "Test for Determination of Non-Combustibility in Building Materials".
- (7) Section 5 contains requirements for the installation of fire doors and fire dampers in fire-rated stud wall assemblies.
- (8) Section 6 contains background information regarding fire test reports, obsolete materials and assemblies, assessment of archaic assemblies and the development of the component additive method.

1.1.2. Referenced Documents

- (1) Where documents are referenced in this Supplementary Standard, they shall be the editions designated in Table 1.1.2.

Table 1.1.2.
Documents Referenced in SB-2 Fire-Performance Ratings

Issuing Agency	Document Number	Title of Document	Reference
ANSI	A208.1-2009	Particleboard	Table 3.1.1.A.
ASTM	C330 / C330M-13	Lightweight Aggregates for Structural Concrete	1.4.3.(2)
ASTM	C840-13	Application and Finishing of Gypsum Board	2.3.9.(1)
ASTM	C1396 / C1396M-14	Gypsum Board	1.5.1.(1); 1.5.1.(2) Table 3.1.1.A.
CCBFC	NRCC 30629	Supplement to the National Building Code of Canada 1990	6.2.; 6.3.; 6.4.
CGSB	4-GP-36M-1978	Carpet Underlay, Fibre Type	Table 3.1.1.B.
CGSB	CAN/CGSB-4.129-97	Carpets for Commercial Use	Table 3.1.1.B.
CGSB	CAN/CGSB-11.3-M87	Hardboard	Table 3.1.1.A.
CGSB	CAN/CGSB-92.2-M90	Trowel or Spray Applied Acoustical Material	2.3.4.(5)
CSA	A23.1-14 / A23.2-14	Concrete Materials and Methods of Concrete Construction / Test Methods and Standard Practices for Concrete	1.4.3.(1)
CSA	A23.3-14	Design of Concrete Structures	2.1.5.(2); 2.6.6.(1) Table 2.6.6.B. 2.8.2.(1); Table 2.8.2.
CSA	CAN/CSA-A82-14	Fired Masonry Brick Made from Clay or Shale	Table 2.6.1.A.
CSA	A82.22-M1977	Gypsum Plasters	Table 3.1.1.A.
CSA	CAN/CSA-A82.27-M91	Gypsum Board	1.5.1.(1); 1.5.1.(2) Table 3.1.1.A.
CSA	A82.30-M1980	Interior Furring, Lathing and Gypsum Plastering	1.7.2.(1); 2.3.9.(1) Table 2.5.1.
CSA	A165.1-14	Concrete Block Masonry Units	Table 2.1.1.
CSA	O86-14	Engineering Design in Wood	2.11.2.(1); 2.11.2.(2)
CSA	O112.10-08	Evaluation of Adhesives for Structural Wood Products (Limited Moisture Exposure)	2.3.6.(4)
CSA	O121-08	Douglas Fir Plywood	Table 3.1.1.A.
CSA	O141-05	Softwood Lumber	2.3.6.(2); Table 2.4.1.
CSA	O151-09	Canadian Softwood Plywood	Table 3.1.1.A.
CSA	O153-13	Poplar Plywood	Table 3.1.1.A.
CSA	O325-07	Construction Sheathing	Table 3.1.1.A.
CSA	O437.0-93	OSB and Waferboard	Table 3.1.1.A.
CSA	S16-14	Design of Steel Structures	2.6.6.(1); 2.6.6.(3) Table 2.6.6.B.
Column 1	2	3	4

Table 1.1.2. (Cont'd)
Documents Referenced in SB-2 Fire-Performance Ratings

Issuing Agency	Document Number	Title of Document	Code Reference
NFPA	80-2013	Fire Doors and Other Opening Protectives	5.2.1.(1); 5.2.1.(2)
ULC	CAN/ULC-S101-14	Fire Endurance Tests of Building Construction and Materials	1.1.1.(4); 1.12.1. 2.3.2.
ULC	CAN/ULC-S102-10	Test for Surface Burning Characteristics of Building Materials and Assemblies	1.1.1.(5)
ULC	CAN/ULC-S102.2-10	Test for Surface Burning Characteristics of Flooring, Floor Coverings, and Miscellaneous Materials and Assemblies	1.1.1.(5) Table 3.1.1.B.
ULC	CAN/ULC-S112.2-07	Fire Test of Ceiling Firestop Flap Assemblies	2.3.10.; 2.3.11.
ULC	CAN/ULC-S114-05	Test for Determination of Non-Combustibility in Building Materials	1.1.1.(6) 4.1.1.; 4.2.1.
ULC	CAN/ULC-S702-14	Mineral Fibre Thermal Insulation for Buildings	Table 2.3.4.A. Table 2.3.4.D. 2.3.5.(2); 2.3.5.(4) Table 2.6.1.E.; 6.4.
ULC	CAN/ULC-S703-09	Cellulose Fibre Insulation for Buildings	2.3.4.(5)
ULC	CAN/ULC-S706.1-16	Wood Fibre Thermal Insulation for Buildings	Table 3.1.1.A.
Column 1	2	3	4

Notes to Table 1.3.1.2.:

(1) Some titles have been abridged to omit superfluous wording.

1.1.3. Applicability of Ratings

(1) The ratings shown in this document apply if more specific test values are not available. The construction of an assembly that is the subject of an individual test report must be followed in all essential details if the fire-resistance rating reported is to be applied for use with the Building Code.

1.1.4. Higher Ratings

(1) The authority having jurisdiction may allow higher fire-resistance ratings than those derived from this Supplementary Standard, where supporting evidence justifies a higher rating. Additional information is provided in summaries of published test information and the reports of fire tests carried out by NRC, which are included in Section 6, Background Information.

1.1.5. Additional Information on Fire Rated Assemblies

(1) Assemblies containing materials for which there is no nationally recognized standard are not included in this Supplementary Standard. Many such assemblies have been rated by Underwriters Laboratories (UL), Underwriters' Laboratories of Canada (ULC) or Intertek Testing Services NA Ltd. (ITS).

1.2. Interpretation of Test Results

1.2.1. Limitations

- (1) The fire-performance ratings set out in this Supplementary Standard are based on those that would be obtained from the standard methods of test described in the Building Code. The test methods are essentially a means of comparing the performance of one building component or assembly with another in relation to its performance in fire.
- (2) Since it is not practicable to measure the fire resistance of constructions in situ, they must be evaluated under some agreed test conditions. A specified fire-resistance rating is not necessarily the actual time that the assembly would endure in situ in a building fire, but is that which the particular construction must meet under the specified methods of test.
- (3) Considerations arising from departures in use from the conditions established in the standard test methods may, in some circumstances, have to be taken into account by the designer and the authority having jurisdiction. Some of these conditions are covered at present by the provisions of the Building Code.
- (4) For walls and partitions, the stud spacing previously specified as 16 and 24 inch on centre have been converted to 406 and 610 mm respectively to represent actual stud spacing used in the field to accommodate modular sheathing panel dimensions. These metric dimensions are deemed to comply with test results based on reported stud spacing of 400 mm or 600 mm on centre.

1.3. Concrete

1.3.1. Aggregates in Concrete

- (1) Low density aggregate concretes generally exhibit better fire performance than natural stone aggregate concretes. A series of tests on concrete masonry walls, combined with mathematical analysis of the test results, has allowed further distinctions between certain low density aggregates to be made.

1.4. Types of Concrete

1.4.1. Description

- (1) For purposes of this Supplementary Standard, concretes are described as Types S, N, L, L₁, L₂, L40S, L₁20S or L₂20S as described in Sentences (2) to (8).
- (2) Type S concrete is the type in which the coarse aggregate is granite, quartzite, siliceous gravel or other dense materials containing at least 30% quartz, chert or flint.
- (3) Type N concrete is the type in which the coarse aggregate is cinders, broken brick, blast furnace slag, limestone, calcareous gravel, trap rock, sandstone or similar dense material containing not more than 30% of quartz, chert or flint.
- (4) Type L concrete is the type in which all the aggregate is expanded slag, expanded clay, expanded shale or pumice.
- (5) Type L₁ concrete is the type in which all the aggregate is expanded shale.
- (6) Type L₂ concrete is the type in which all the aggregate is expanded slag, expanded clay or pumice.
- (7) Type L40S concrete is the type in which the fine portion of the aggregate is sand and low density aggregate in which the sand does not exceed 40% of the total volume of all aggregates in the concrete.
- (8) Type L₁20S and Type L₂20S concretes are the types in which the fine portion of the aggregate is sand and low density aggregate in which the sand does not exceed 20% of the total volume of all aggregates in the concrete.

1.4.2. Determination of Ratings

(1) Where concretes are described as being of Type S, N, L, L₁ or L₂, the rating applies to the concrete containing the aggregate in the group that provides the least fire resistance. If the nature of an aggregate cannot be determined accurately enough to place it in one of the groups, the aggregate shall be considered as being in the group that requires a greater thickness of concrete for the required fire resistance.

1.4.3. Description of Aggregates

(1) The descriptions of the aggregates in Type S and Type N concretes apply to the coarse aggregates only. Coarse aggregate for this purpose means that retained on a 5 mm sieve using the method of grading aggregates described in CSA A23.1 / A23.2, "Concrete Materials and Methods of Concrete Construction / Test Methods and Standard Practices for Concrete".

(2) Increasing the proportion of sand as fine aggregate in low density concretes requires increased thicknesses of material to produce equivalent fire-resistance ratings. Low density aggregates for Type L and Types L-S concretes used in loadbearing components shall conform to ASTM C330 / C330M, "Lightweight Aggregates for Structural Concrete".

(3) Non-loadbearing low density components of vermiculite and perlite concrete, in the absence of other test evidence, shall be rated on the basis of the values shown for Type L concrete.

1.5. Gypsum Board

1.5.1. Types of Gypsum Board

(1) Where the term "gypsum board" is used in this Supplementary Standard, it is intended to include, in addition to gypsum board, gypsum backing board and gypsum base for veneer plaster as described in

- (a) CAN/CSA-A82.27-M, "Gypsum Board", or
- (b) ASTM C1396 / C1396M, "Gypsum Board".

(2) Where the term "Type X gypsum board" is used in this Supplementary Standard, it applies to special fire-resistant gypsum board as described in

- (a) CAN/CSA-A82.27-M, "Gypsum Board", or
- (b) ASTM C1396 / C1396M, "Gypsum Board".

1.6. Equivalent Thickness

1.6.1. Method of Calculating

(1) The thickness of solid-unit masonry and concrete described in this Supplementary Standard shall be the thickness of solid material in the unit or component thickness. For units that contain cores or voids, the Tables refer to the equivalent thickness determined in conformance with Sentences (2) to (10).

(2) Where a plaster finish is used, the equivalent thickness of a wall, floor, column or beam protection shall be equal to the sum of the equivalent thicknesses of the concrete or masonry units and the plaster finish measured at the point that will give the least value of equivalent thickness.

(3) Except as provided in Sentence (5), the equivalent thickness of a hollow masonry unit shall be calculated as equal to the actual overall thickness of a unit in millimetres multiplied by a factor equal to the net volume of the unit and divided by its gross volume.

(4) Net volume shall be determined using a volume displacement method that is not influenced by the porous nature of the units.

(5) Gross volume of a masonry unit shall be equal to the actual length of the unit multiplied by the actual height of the unit multiplied by the actual thickness of the unit.

(6) Where all the core spaces in a wall of hollow concrete masonry or hollow-core precast concrete units are filled with grout, mortar, or loose fill materials such as expanded slag, burned clay or shale (rotary kiln process), vermiculite or perlite, the equivalent thickness rating of the wall shall be considered to be the same as that of a wall of solid units, or a solid wall of the same concrete type and the same overall thickness.

(7) The equivalent thickness of hollow-core concrete slabs and panels having a uniform thickness and cores of constant cross section throughout their length shall be obtained by dividing the net cross-sectional area of the slab or panel by its width.

(8) The equivalent thickness of concrete panels with tapered cross sections shall be the cross section determined at a distance of $2t$ or 150 mm, whichever is less, from the point of minimum thickness, where t is the minimum thickness.

(9) Except as permitted in Sentence (10), the equivalent thickness of concrete panels with ribbed or undulating surfaces shall be

- (a) t_a for s less than or equal to $2t$,
- (b) $t + (4t/s - 1)(t_a - t)$ for s less than $4t$ and greater than $2t$, and
- (c) t for s greater than or equal to $4t$

where

t = minimum thickness of panel,

t_a = average thickness of panel (unit cross-sectional area divided by unit width), and

s = centre to centre spacing of ribs or undulations.

(10) Where the total thickness of a panel described in Sentence (9), exceeds $2t$, only that portion of the panel which is less than $2t$ from the non-ribbed surface shall be considered for the purpose of the calculations in Sentence (9).

1.7. Contribution of Plaster or Gypsum Board Finish to Fire Resistance of Masonry or Concrete

1.7.1. Determination of Contribution

(1) Except as provided in Sentences (2) to (5), the contribution of a plaster or gypsum board finish to the fire resistance of a masonry or concrete wall, floor or roof assembly shall be determined by multiplying the actual thickness of the finish by the factor shown in Table 1.7.1., depending on the type of masonry or concrete to which it is applied. This corrected thickness shall then be included in the equivalent thickness as described in Subsection 1.6.

(2) Where a plaster or gypsum board finish is applied to a concrete or masonry wall, the calculated fire-resistance rating of the assembly shall not exceed twice the fire-resistance rating provided by the masonry or concrete because structural collapse may occur before the limiting temperature is reached on the surface of the non-fire-exposed side of the assembly.

(3) Where a plaster or gypsum board finish is applied only on the non-fire-exposed side of a hollow clay tile wall, no increase in fire resistance is permitted because structural collapse may occur before the limiting temperature is reached on the surface of the non-fire-exposed side of the assembly.

(4) The contribution to fire resistance of a plaster or gypsum board finish applied to the non-fire-exposed side of a monolithic concrete or unit masonry wall shall be determined in conformance with Sentence (1), but shall not exceed 0.5 times the contribution of the concrete or masonry wall.

(5) When applied to the fire-exposed side, the contribution of a gypsum lath and plaster or gypsum board finish to the fire resistance of masonry or concrete wall, floor or roof assemblies shall be determined from Table 2.3.4.A. or 2.3.4.B.

Table 1.7.1.
Multiplying Factors for Masonry or Concrete Construction

Type of Surface Protection	Type of Masonry or Concrete			
	Solid Clay Brick, Unit Masonry and Monolithic Concrete, Type N or S	Cored Clay Brick, Clay Tile, Monolithic Concrete, Type L40S and Unit Masonry, Type L ₁ 20S	Concrete Unit Masonry, Type L ₁ or L ₂ 20S and Monolithic Concrete, Type L	Concrete Unit Masonry, Type L ₂
Portland cement-sand plaster or lime sand plaster	1.00	0.75	0.75	0.50
Gypsum-sand plaster, wood fibred gypsum plaster or gypsum board	1.25	1.00	1.00	1.00
Vermiculite or perlite aggregate plaster	1.75	1.50	1.25	1.25
Column 1	2	3	4	5

1.7.2. Plaster

- (1) Gypsum plastering shall conform to CSA A82.30-M, "Interior Furring, Lathing and Gypsum Plastering".
- (2) Portland cement-sand plaster shall be applied in 2 coats: the first coat containing 1 part Portland cement to 2 parts sand by volume, and the second coat containing 1 part Portland cement to 3 parts sand by volume.
- (3) Plaster finish shall be securely bonded to the wall or ceiling.
- (4) The thickness of plaster finish applied directly to monolithic concrete without metal lath shall not exceed 10 mm on ceilings and 16 mm on walls.
- (5) Where the thickness of plaster finish on masonry or concrete exceeds 38 mm, wire mesh with 1.57 mm diam wire and openings not exceeding 50 mm by 50 mm shall be embedded midway in the plaster.

1.7.3. Attachment of Gypsum Board and Lath

- (1) Gypsum board and gypsum lath finishes applied to masonry or concrete walls shall be secured to wood or steel furring members in conformance with Article 2.3.9.

1.7.4. Sample Calculations

- (1) The following examples are included as a guide to the method of calculating the fire resistance of concrete or hollow masonry walls with plaster or gypsum board protection:

Example (1)

A 3 h fire-resistance rating is required for a monolithic concrete wall of Type S aggregate with a 20 mm gypsum-sand plaster finish on metal lath on each face.

- (a) The minimum equivalent thickness of Type S monolithic concrete needed to give a 3 h fire-resistance rating = 158 mm (Table 2.1.1.).
- (b) Since the gypsum-sand plaster finish is applied on metal lath, Sentence 1.7.1.(5) does not apply. Therefore, the contribution to the equivalent thickness of the wall of 20 mm gypsum-sand plaster on each face of the concrete is $20 \times 1.25 = 25$ mm (see Sentences 1.7.1.(1) to (4)).
- (c) The total contribution of the plaster finishes is $2 \times 25 = 50$ mm.
- (d) The minimum equivalent thickness of concrete required is $158 \text{ mm} - 50 \text{ mm} = 108$ mm.
- (e) From Table 2.1.1., the 108 mm equivalent thickness of monolithic concrete gives a contribution of less than 1.5 h. This is less than half the rating of the assembly so that the conditions in Sentence 1.7.1.(2) are not met. Thus the equivalent thickness of monolithic concrete must be increased to 112 mm to give 1.5 h contribution.
- (f) The total equivalent thickness of the plaster finishes can then be reduced to $158 \text{ mm} - 112 \text{ mm} = 46$ mm.
- (g) The total actual thickness of the plaster finishes required is therefore $46 \text{ mm} \div 1.25 = 37$ mm (Sentences 1.7.1.(1) to (4)) or 18.5 mm on each face.
- (h) Since the thickness of the plaster finish on each face exceeds 16 mm, metal lath is still required (Sentence 1.7.2.(4)).
- (i) Since this wall is symmetrical with plaster on both faces, the contribution to fire resistance of the plaster finish on either face is limited to one-quarter of the wall rating by virtue of Sentence 1.7.1.(2). Under these circumstances, the conditions in Sentence 1.7.1.(4) are automatically met.

Example (2)

A 2 h fire-resistance rating is required for a hollow masonry wall of Type N concrete with a 12.7 mm Type X gypsum board finish on each face.

- (a) Since gypsum board is used, Sentence 1.7.1.(5) applies. The 12.7 mm gypsum board finish on the fire-exposed side is, therefore, assigned 25 min by using Table 2.3.4.A.
- (b) The fire resistance required of the balance of the assembly is $120 \text{ min} - 25 \text{ min} = 95$ min.
- (c) Interpolating between 1.5 h and 2 h in Table 2.1.1. for 95 min fire resistance, the equivalent thickness for hollow masonry units required is $95 \text{ mm} + (18 \text{ mm} \times 5/30) = 95 \text{ mm} + 3 \text{ mm} = 98$ mm.
- (d) The contribution to the equivalent thickness of the wall of the 12.7 mm gypsum board finish on the non-fire-exposed side using Table 1.7.1. = $12.7 \times 1.25 = 16$ mm.
- (e) Equivalent thickness required of concrete masonry unit = $98 - 16 = 82$ mm.
- (f) The fire-resistance rating of a concrete masonry wall having an equivalent thickness of 82 mm = 1 h for 73 mm + $(9 \text{ mm} \times 30/22) = 1 \text{ h } 12 \text{ min}$. As this is more than 1 h, the conditions of Sentence 1.7.1.(2) are met and the rating of 2 h is justified.

Example (3)

A 2 h fire-resistance rating is required for a hollow masonry exterior wall of Type L₂20S concrete with a 15.9 mm Type X gypsum board finish on the non-fire-exposed side only.

- (a) According to Table 2.1.1., the minimum equivalent thickness for Type L₂20S concrete masonry units needed to achieve a 2 h rating is 94 mm.
- (b) Since gypsum board is not used on the fire-exposed side, Sentence 1.7.1.(5) does not apply. The contribution to the equivalent thickness of the wall by the 15.9 mm Type X gypsum board finish applied on the non-fire-exposed side is $15.9 \times 1 \approx 16$ mm (see Sentence 1.7.1.(1) and Table 1.7.1.).
- (c) Therefore, the equivalent thickness required of the concrete masonry unit is $94 - 16 = 78$ mm.
- (d) The contribution to fire resistance of a 78 mm L₂20S concrete hollow masonry unit is 85 min. The contribution of the Type X gypsum board finish is $120 - 85 = 35$ min, which does not exceed half the 85 min contribution of the masonry unit or 42.5 min, so that the conditions in Sentence 1.7.1.(4) are met.
- (e) The rating of the wall (120 min) is less than twice the contribution of the masonry unit (170 min) so that the conditions in Sentence 1.7.1.(2) are also met.

1.8. Tests on Floors and Roofs

1.8.1. Exposure to Fire

(1) All tests relate to the performance of a floor assembly or floor-ceiling or roof-ceiling assembly above a fire. It has been assumed on the basis of experience that fire on top will take a longer time to penetrate the floor than one below, and that the fire resistance in such a situation will be at least equal to that obtained from below in the standard test.

1.9. Moisture Content

1.9.1. Effect of Moisture

(1) The moisture content of building materials at the time of fire test may have a significant influence on the measured fire resistance. In general, an increase in the moisture content should result in an increase in the fire resistance, though in some materials the presence of moisture may produce disruptive effects and early collapse of the assembly.

(2) Moisture content is now controlled in standard fire test methods and is generally recorded in the test reports. In earlier tests, moisture content was not always properly determined.

1.10. Permanence and Durability

1.10.1. Test Conditions

(1) The ratings in this Supplementary Standard relate to tested assemblies and do not take into account possible changes or deterioration in use of the materials. The standard fire test measures the fire resistance of a sample building assembly erected for the test. No judgment as to the permanence or durability of the assembly is made in the test.

1.11. Steel Structural Members

1.11.1. Thermal Protection

(1) Since the ability of a steel structural member to sustain the loading for which it was designed may be impaired because of elevated temperatures, measures shall be taken to provide thermal protection. The fire-resistance ratings, as established by the provisions of this Supplementary Standard, indicate the time periods during which the effects of heat on protected steel structural members are considered to be within acceptable limits.

1.12. Restraint Effects

1.12.1. Effect on Fire-Resistance Ratings

(1) In fire tests of floors, roofs and beams, it is necessary to state whether the rating applies to a thermally restrained or thermally unrestrained assembly. Edge restraint of a floor or roof, structural continuity, or end restraint of a beam can significantly extend the time before collapse in a standard test. A restrained condition is one in which expansion or rotation at the supports of a load-carrying element resulting from the effects of fire is resisted by forces or moments external to the element. An unrestrained condition is one in which the load-carrying element is free to thermally expand and rotate at its supports.

Whether an assembly or structural member can be considered thermally restrained or thermally unrestrained depends on the type of construction and location in a building. Guidance on this subject can be found in Appendix A of CAN/ULC-S101, "Fire Endurance Tests of Building Construction and Materials". Different acceptance criteria also apply to thermally unrestrained and thermally restrained assemblies. These are described in CAN/ULC-S101.

The ratings for floors, roofs, and beams in this Supplementary Standard meet the conditions of CAN/ULC-S101, "Fire Endurance Tests of Building Construction and Materials" for thermally unrestrained specimens. In a thermally restrained condition, the structural element or assembly would probably have greater fire resistance, but the extent of this increase can be determined only by reference to behavior in a standard test.

Section 2 Fire-Resistance Ratings

2.1. Masonry and Concrete Walls

2.1.1. Minimum Equivalent Thickness for Fire-Resistance Rating

(1) The minimum thicknesses of unit masonry and monolithic concrete walls are shown in Table 2.1.1. Hollow masonry units and hollow-core concrete panels shall be rated on the basis of equivalent thickness as described in Subsection 1.6.

Table 2.1.1.

Minimum Equivalent Thicknesses⁽¹⁾ of Unit Masonry and Monolithic Concrete Walls Loadbearing and Non-Loadbearing, mm

Type of Wall	Fire-Resistance Rating						
	30 min	45 min	1 h	1.5 h	2 h	3 h	4 h
Solid brick units (80% solid and over), actual overall thickness	63	76	90	108	128	152	178
Cored brick units and hollow tile units (less than 80% solid), equivalent thickness	50	60	72	86	102	122	142
Solid and hollow concrete masonry units, equivalent thickness							
Type S or N concrete ⁽²⁾	44	59	73	95	113	142	167
Type L ₁ 20S concrete	42	54	66	87	102	129	152
Type L ₁ concrete	42	54	64	82	97	122	143
Type L ₂ 20S concrete	42	54	64	81	94	116	134
Type L ₂ concrete	42	54	63	79	91	111	127
Monolithic concrete and concrete panels, equivalent thickness							
Type S concrete	60	77	90	112	130	158	180
Type N concrete	59	74	87	108	124	150	171
Type L ₄ 0S or Type L concrete	49	62	72	89	103	124	140
Column 1	2	3	4	5	6	7	8

Notes to Table 2.1.1.:

(1) See definition of equivalent thickness in Subsection 1.6.

(2) Hollow concrete masonry units made with Type S or N concrete shall have a minimum compressive strength of 15 MPa based on net area, as defined in CSA A165.1, "Concrete Block Masonry Units".

2.1.2. Applicability of Ratings

- (1) Ratings obtained as described in Article 2.1.1. apply to either loadbearing or non-loadbearing walls, except for walls described in Sentences (2) to (6).
- (2) Ratings for walls with a thickness less than the minimum thickness prescribed for loadbearing walls in this Supplementary Standard apply to non-loadbearing walls only.
- (3) Masonry cavity walls (consisting of 2 wythes of masonry with an air space between) that are loaded to a maximum allowable compressive stress of 380 kPa have a fire resistance at least as great as that of a solid wall of a thickness equal to the sum of the equivalent thicknesses of the 2 wythes.
- (4) Masonry cavity walls that are loaded to a compressive stress exceeding 380 kPa are not considered to be within the scope of this Supplementary Standard.
- (5) A masonry wall consisting of 2 types of masonry units, either bonded together or in the form of a cavity wall, shall be considered to have a fire-resistance rating equal to that which would apply if the whole of the wall were of the material that gives the lesser rating.
- (6) A non-loadbearing cavity wall made up of 2 precast concrete panels with an air space or insulation in the cavity between them shall be considered to have a fire-resistance rating as great as that of a solid wall of a thickness equal to the sum of the thicknesses of the 2 panels.

2.1.3. Framed Beams and Joists

- (1) Beams and joists that are framed into a masonry or concrete fire separation shall not reduce the thickness of the fire separation to less than the equivalent thickness required for the fire separation.

2.1.4. Credit for Plaster Thickness

- (1) On monolithic walls and walls of unit masonry, the full plaster finish on one or both faces multiplied by the factor shown in Table 1.7.1. shall be included in the wall thickness shown in Table 2.1.1., under the conditions and using the methods described in Subsection 1.7.

2.1.5. Walls Exposed to Fire on Both Sides

- (1) Except as permitted in Sentence (2), portions of loadbearing reinforced concrete walls, which do not form a complete fire separation and thus may be exposed to fire on both sides simultaneously, shall have minimum dimensions and minimum cover to steel reinforcement in conformance with Articles 2.8.2. to 2.8.5.
- (2) A concrete wall exposed to fire from both sides as described in Sentence (1) has a fire-resistance rating of 2 h if the following conditions are met:
 - (a) its equivalent thickness is not less than 200 mm,
 - (b) its aspect ratio (width/thickness) is not less than 4.0,
 - (c) the minimum thickness of concrete cover over the steel reinforcement specified in Clause (d) is not less than 50 mm,
 - (d) each face of the wall is reinforced with both vertical and horizontal steel reinforcement in conformance with either Clause 10 or Clause 14 of CSA A23.3, "Design of Concrete Structures",
 - (e) the structural design of the wall is governed by the minimum eccentricity $(15 + 0.03h)$ specified in Clause 10.15.3.1. of CSA A23.3, "Design of Concrete Structures", and
 - (f) the effective length of the wall, kl_u , is not more than 3.7 m

where

k = effective length factor obtained from CSA A23.3, "Design of Concrete Structures",

l_u = unsupported length of the wall in metres.

2.2. Reinforced and Prestressed Concrete Floor and Roof Slabs

2.2.1. Assignment of Rating

(1) Floors and roofs in a fire test are assigned a fire-resistance rating which relates to the time that an average temperature rise of 140°C or a maximum temperature rise of 180°C at any location is recorded on the unexposed side, or the time required for collapse to occur, whichever is the lesser. The thickness of concrete shown in Table 2.2.1.A. shall be required to resist the transfer of heat during the fire resistance period shown.

(2) The concrete cover over the reinforcement and steel tendons shown in Table 2.2.1.B. shall be required to maintain the integrity of the structure and prevent collapse during the same period.

Table 2.2.1.A.
Minimum Thickness of Reinforced and Prestressed Concrete Floor or Roof Slabs, mm

Type of Concrete	Fire-Resistance Rating						
	30 min	45 min	1 h	1.5 h	2 h	3 h	4 h
Type S concrete	60	77	90	112	130	158	180
Type N concrete	59	74	87	108	124	150	171
Type L40S or Type L concrete	49	62	72	89	103	124	140
Column 1	2	3	4	5	6	7	8

Table 2.2.1.B.
Minimum Concrete Cover Over Reinforcement in Concrete Slabs, mm

Type of Concrete	Fire-Resistance Rating						
	30 min	45 min	1 h	1.5 h	2 h	3 h	4 h
Type S, N, L40S or L concrete	20	20	20	20	25	32	39
Prestressed concrete slabs Type S, N, L40S or L Concrete	20	25	25	32	39	50	64
Column 1	2	3	4	5	6	7	8

2.2.2. Floors With Hollow Units

(1) The fire resistance of floors containing hollow units may be determined on the basis of equivalent thickness as described in Subsection 1.6.

2.2.3. Composite Slabs

(1) For composite concrete floor and roof slabs consisting of one layer of Type S or N concrete and another layer of Type L40S or L concrete in which the minimum thickness of both the top and bottom layers is not less than 25 mm, the combined fire-resistance rating may be determined using the following expressions:

(a) when the base layer consists of Type S or N concrete,

$$R = 0.00018t^2 - 0.00009dt + \frac{8.7}{t}$$

- (b) when the base layer consists of Type L40S or L concrete,

$$R = 0.0001t^2 + 0.0002dt - 0.0001d^2 + \frac{6.4}{t}$$

where

- R = fire resistance of slab, h,
 t = total thickness of slab, mm, and
 d = thickness of base layer, mm.

(2) If the base course described in Sentence (1) is covered by a top layer of material other than Type S, N, L40S or L concrete, the top course thickness may be converted to an equivalent concrete thickness by multiplying the actual thickness by the appropriate factor listed in Table 2.2.3.A. This equivalent concrete thickness may be added to the thickness of the base course and the fire-resistance rating calculated using Table 2.2.1.A.

(3) The minimum concrete cover under the main reinforcement for composite concrete floor and roof slabs with base slabs less than 100 mm thick shall conform to Table 2.2.3.B. For base slabs 100 mm or more thick, the minimum cover thickness requirements of Table 2.2.1.B. shall apply.

(4) Where the top layer of a 2-layer slab is less than 25 mm thick, the fire-resistance rating for the slab shall be calculated as though the entire slab were made up of the type of concrete with the lesser fire resistance.

Table 2.2.3.A.
Multiplying Factors for Equivalent Thickness

Top Course Material	Base Slab Normal Density Concrete (Type S or N)	Base Slab Low Density Concrete (Type L40S or L)
Gypsum board	3.00	2.25
Cellular concrete (mass density 400 - 560 kg/m ³)	2.00	1.50
Vermiculite and perlite concrete (mass density 560 kg/m ³ or less)	1.75	1.50
Portland cement with sand aggregate	1.00	0.75
Terrazzo	1.00	0.75
Column 1	2	3

Table 2.2.3.B.
Minimum Concrete Cover Under Bottom Reinforcement in Composite Concrete Slabs, mm

Base Slab Concrete Type	Fire-Resistance Rating						
	30 min	45 min	1 h	1.5 h	2 h	3 h	4 h
Reinforced concrete							
Type S, N, L40S or L	15	15	20	25	30	40	55
Prestressed concrete							
Type S	20	25	30	40	50	65	75
Type N	20	20	25	35	45	60	70
Type L40S or L	20	20	25	30	40	50	60
Column 1	2	3	4	5	6	7	8

2.2.4. Contribution of Plaster Finish

- (1) The contribution of plaster finish securely fastened to the underside of concrete may be taken into account in floor or roof slabs under the conditions and using the methods described in Subsection 1.7.
- (2) Plaster finish on the underside of concrete floors or roofs may be used in lieu of concrete cover referred to in Sentence 2.2.1.(2) under the conditions and using the methods described in Subsection 1.7.

2.2.5. Concrete Cover

- (1) In prestressed concrete slab construction, the concrete cover over an individual tendon shall be the minimum thickness of concrete between the surface of the tendon and the fire-exposed surface of the slab, except that for ungrouted ducts the assumed cover thickness shall be the minimum thickness of concrete between the surface of the duct and the bottom of the slab. For slabs in which several tendons are used, the cover is assumed to be the average of those of individual tendons, except that the cover for any individual tendon shall be not less than half of the value given in Table 2.2.1.B. nor less than 20 mm.
- (2) Except as provided in Sentence (3), in post-tensioned prestressed concrete slabs, the concrete cover to the tendon at the anchor shall be not less than 15 mm greater than the minimum cover required by Sentence (1). The minimum concrete cover to the anchorage bearing plate and to the end of the tendon, if it projects beyond the bearing plate, shall be 20 mm.
- (3) The requirements of Sentence (2) do not apply to those portions of slabs not likely to be exposed to fire, such as the ends and tops.

2.2.6. Minimum Dimensions for Cover

- (1) Minimum dimensions and cover to steel tendons of prestressed concrete beams shall conform to Subsection 2.10.

2.3. Wood and Steel Framed Walls, Floors and Roofs

2.3.1. Maximum Fire-Resistance Rating

- (1) The fire-resistance rating of walls constructed of wood studs or cold-formed-steel studs, of floors constructed of wood joists, wood I-joists, pre-manufactured wood trusses, cold-formed-steel joists or open web steel joists, and of roofs constructed of wood joists, pre-manufactured metal-plate-connected wood trusses or open web steel joists, can be determined for ratings of not more than 90 min from the information in this Subsection.

2.3.2. Loadbearing Conditions

- (1) The fire-resistance ratings derived from the information in this Subsection apply to loadbearing and non-loadbearing wood-framed and cold-formed-steel-framed walls, and to loadbearing floors and roofs, as specifically described in this Subsection.
- (2) Loadbearing conditions shall be as defined in CAN/ULC-S101, "Fire Endurance Tests of Building Construction and Materials".

2.3.3. Limitations of Component Additive Method (See Section 6 Background Information.)

- (1) The fire-resistance rating of a framed assembly depends primarily on the time during which the membrane on the fire-exposed side remains in place.
- (2) The assigned times in Sentences 2.3.4.(2) to (4) are not intended to be construed as the fire-resistance ratings of the individual components of an assembly, nor are they intended to be construed as times that are applicable or acceptable for use beyond the method and systems described in this Subsection. These assigned times are the individual contributions of each component to the overall fire-resistance rating of an assembly, which are permitted to be derived using the component additive method described in this Subsection..
- (3) The fire-resistance rating calculated by the component additive method cannot be increased by installing membranes in multiple layers, other than as specified in Tables 2.3.4.A., 2.3.4.B. and 2.3.4.C.

2.3.4. Method of Calculation

- (1) In the component additive method, the fire-resistance rating of a framed assembly is calculated by adding the time assigned in Sentence (2) for the membrane on the fire-exposed side to the time assigned in Sentence (3) for the framing members and then adding any time assigned in Sentence (4) for additional protective measures, such as the inclusion of insulation or of reinforcement of a membrane. For loadbearing walls where resilient metal channels are installed with a single layer of gypsum board membrane in accordance with Table 2.3.4.A, the fire-resistance rating determined using this method of calculation must be reduced by 10 min.
- (2) The times to be used in the component additive method that have been assigned to membranes on the fire-exposed side of the assembly, which are partly based on their ability to remain in place during fire tests, are listed in Tables 2.3.4.A., 2.3.4.B., 2.3.4.C. and 2.3.4.D. (This is not to be confused with the fire-resistance rating of the membrane, which also takes into account the rise in temperature on the unexposed side of the membrane. [See Sentence 2.3.3.(2).])
- (3) The times to be used in the component additive method that have been assigned to wall framing members and to floor and roof framing members are listed in Tables 2.3.4.E. and 2.3.4.F. respectively.
- (4) Preformed insulation of glass, rock or slag fibre and cellulose fibre insulation provide additional protection to wood studs by shielding the studs from exposure to the fire and thus delaying the time of collapse. The use of preformed glass fibre, preformed rock or slag fibre and dry-blown cellulose insulation material does not decrease the rating of wall assemblies with the membranes identified in Table 2.3.4.A. Similarly, the use of preformed glass fibre, preformed rock or slag fibre and cellulose insulation material does not decrease the rating of floors joists constructed with wood joists, wood trusses, wood I-joists and cold-formed-steel floor joists (C-shaped joists), provided the insulation is not in direct contact with the members identified in Table 2.3.4.B. The use of reinforcement in the membrane exposed to fire also adds to the fire resistance by extending the time to failure. Table 2.3.4.G. shows the time increments that may be added to the fire resistance if these features are incorporated in the assembly.
- (5) Cellulose fibre insulation conforming to CAN/ULC-S703, "Cellulose Fibre Insulation for Buildings", applied in conformance with CAN/CGSB-92.2-M, "Trowel or Spray Applied Acoustical Material", does not affect the fire-resistance rating of a non-loadbearing cold-formed-steel stud wall assembly, provided that it is sprayed to either face of the wall cavity.

Table 2.3.4.A.
Time Assigned to Protective Membranes on Fire-Exposed Side of Wood-Framed and Cold-Formed-Steel-Framed Walls

Description of Finish	Time, min	
	Loadbearing Walls	Non-Loadbearing Walls
11.0 mm Douglas Fir plywood phenolic bonded	—	10 ⁽¹⁾
14.0 mm Douglas Fir plywood phenolic bonded	—	15 ⁽¹⁾
12.7 mm Type X gypsum board	25 ⁽²⁾	25
15.9 mm Type X gypsum board	40 ⁽²⁾	40 ⁽³⁾
Double 12.7 mm Type X gypsum board ⁽⁴⁾	50	80
Column 1	2	3

Notes to Table 2.3.4.A.:

- (1) Applies to stud cavities filled with mineral wool conforming to CAN/ULC-S702, "Mineral Fibre Thermal Insulation for Buildings", and having a mass per unit area of not less than 2 kg/m², with no additional credit for insulation according to Table 2.3.4.G.
- (2) Applies only to wood-framed walls.
- (3) Applies only to steel-framed walls.
- (4) Resilient metal channels are permitted to be installed at a spacing of 406 mm o.c. with no effect on the rating of the wall assembly.

Table 2.3.4.B.
Time Assigned to Gypsum Board Membranes on Fire-Exposed Side of Floors

Description of Finish	Resilient Metal Channels ⁽¹⁾	Time, min	
		Floors with Wood or Steel Joists	Floors with Open-Web Steel Joists
12.7 mm Type X gypsum board	Spaced ≤ 406 mm o.c. ⁽²⁾	25 ⁽³⁾	—
15.9 mm Type X gypsum board		40	—
12.7 mm Type X gypsum board	—	25 ⁽⁴⁾	25
15.9 mm Type X gypsum board		40 ⁽⁴⁾	40
Double 12.7 mm Type X gypsum board	Spaced ≤ 406 mm o.c. ⁽⁵⁾	50 ⁽³⁾	—
Double 12.7 mm Type X gypsum board	Spaced at 610 mm o.c. ⁽⁶⁾	45 ⁽³⁾	—
Double 15.9 mm Type X gypsum board	Spaced ≤ 610 mm o.c. ⁽⁶⁾	60 ⁽³⁾	—
Column 1	2	3	4

Notes to Table 2.3.4.B.:

- (1) See Figures 1, 2 and 4 in MMAH Supplementary Standard SB-3, "Fire and Sound Resistance of Building Assemblies" for the attachment of single and double layers of gypsum board to resilient metal channels.
- (2) Resilient metal channels must be installed to achieve the stated rating.
- (3) Applies to wood joists, wood trusses, wood I-joists and cold-formed steel joists (C-shaped joists).
- (4) Applies to wood joists and pre-fabricated metal-plate-connected wood trusses.
- (5) Resilient metal channels must be installed or gypsum board must be applied directly to the structural members, which must be spaced not more than 406 mm o.c.
- (6) Resilient metal channels are permitted to be installed with no effect on the rating of the floor assembly. Gypsum board is also permitted to be applied directly to the structural members.

Table 2.3.4.C.
Time Assigned to Gypsum Board Membranes on Fire-Exposed Side of Roofs

Description of Finish	Time, min ⁽¹⁾
12.7 mm Type X gypsum board	25
15.9 mm Type X gypsum board	40
Column 1	2

Notes to Table 2.3.4.C.:

- (1) Applies to wood joists, pre-fabricated metal-plate-connected wood trusses and open-web steel joists with ceiling supports spaced not more than 406 mm o.c.

Table 2.3.4.D.
Time Assigned for Contribution of Lath and Plaster Protection on Fire-Exposed Side

Type of Lath	Plaster Thickness, mm	Type of Plaster Finish		
		Portland Cement and Sand ⁽¹⁾ or Lime and Sand	Gypsum and Sand or Gypsum Wood Fibre	Gypsum and Perlite or Gypsum and Vermiculite
		Time, min ⁽²⁾		
9.5 mm gypsum	13	—	35	55
	16	—	40	65
	19	—	50	80 ⁽³⁾
Metal	19	20	50	80 ⁽³⁾
	23	25	65	80 ⁽³⁾
	26	30	80	80 ⁽³⁾
Column 1	2	3	4	5

Notes to Table 2.3.4.D.:

- (1) For mixture of Portland cement-sand plaster, see Sentence 1.7.2.(2).
 (2) Applies to loadbearing and non-loadbearing wood studs or non-loadbearing cold-formed-steel studs, to floors constructed of wood joists or open-web steel joists, and to roofs constructed of wood joists, pre-manufactured metal-plate-connected wood trusses or open-web steel joists.
 (3) Values shown for these membranes have been limited to 80 min because the fire-resistance ratings of framed assemblies derived from these Tables must not exceed 1.5 h.

Table 2.3.4.E.
Time Assigned for Contribution of Wood-Framed or Cold-Formed-Steel-Framed Walls

Description of Frame	Time, min	
	Loadbearing Walls	Non-Loadbearing Walls
Wood studs spaced \leq 406 mm o.c.	20	20
Wood studs spaced \leq 610 mm o.c.	15	15
Cold-formed-steel studs spaced \leq 406 mm o.c.	10	10
Cold-formed-steel studs spaced \leq 610 mm o.c.	10	—
Column 1	2	3

Table 2.3.4.F.
Time Assigned for Contribution of Wood or Steel Frame of Floors and Roofs

Description of Frame		Time, min
Type of Assembly	Structural Members	
Floor ⁽¹⁾	Wood joists, wood I-joists, wood trusses and cold-formed-steel joists spaced ≤ 610 mm o.c.	10 ⁽²⁾
	Open-web steel joists with ceiling supports spaced ≤ 406 mm o.c.	
Roof	Wood joists spaced ≤ 406 mm o.c.	10
	Open-web steel joists with ceiling supports spaced ≤ 406 mm o.c.	10
	Wood truss assemblies (metal-plate-connected) spaced ≤ 610 mm o.c.	5
Column 1	2	3

Notes to Table 2.3.4.F.:

- (1) Resilient metal channels are permitted to be installed with no effect on the rating of the floor assembly.
(2) Applies only to floor structural members that are protected by a membrane.

Table 2.3.4.G.
Time Assigned for Additional Protection

Description of Additional Protection	Time, min
Add to the fire-resistance rating of wood stud walls, sheathed with gypsum board or lath and plaster, if the spaces between the studs are filled with preformed insulation of rock or slag fibres conforming to CAN/ULC-S702, "Mineral Fibre Thermal Insulation for Buildings", and with a mass per unit area of not less than 1.22 kg/m ² of wall surface	15 ⁽¹⁾
Add to the fire-resistance rating of non-loadbearing wood stud walls, sheathed with gypsum board or lath and plaster, if the spaces between the studs are filled with preformed insulation of glass fibres conforming to CAN/ULC-S702, "Mineral Fibre Thermal Insulation for Buildings", and having a mass per unit area of not less than 0.6 kg/m ² of wall surface	5 ⁽²⁾
Add to the fire-resistance rating of loadbearing wood stud walls, sheathed with gypsum board if the spaces between the studs are filled with cellulose fibres conforming to CAN/ULC-S703, "Cellulose Fibre Insulation for Buildings", and having a density of not less than 50 kg/m ³	10
Add to the fire-resistance rating of plaster on gypsum lath ceilings if 0.76 mm diam wire mesh with 25 mm by 25 mm openings or 1.57 mm diam diagonal wire reinforcing at 250 mm o.c. is placed between lath and plaster	30
Add to the fire-resistance rating of plaster on gypsum lath ceilings if 76 mm wide metal lath strips are placed over joints between lath and plaster	10
Add to the fire-resistance rating of plaster on 9.5 mm thick gypsum lath ceilings (Table 2.3.4.D.) if supports for lath are 305 mm o.c.	10
Add to the fire-resistance rating of floor assemblies if the spaces between the structural member are filled with preformed insulation of rock or slag fibres conforming to CAN/ULC-S702, "Mineral Fibre Thermal Insulation for Buildings", and having a mass per unit area of not less than 1.22 kg/m ² of floor surface	5 ⁽²⁾
Add to the fire-resistance rating of floor assemblies if the spaces between the structural members studs are filled with wet-blown cellulose fibres conforming to CAN/ULC-S703, "Cellulose Fibre Insulation for Buildings", and having a density of not less than 50 kg/m ³	5 ⁽²⁾⁽³⁾
Add to the fire-resistance rating of floor assemblies where the floor topping on the unexposed side of the floor assemblies consists of concrete not less than 38 mm thick	5 ⁽²⁾
Column 1	2

Notes to Table 2.3.4.G.:

- (1) Applies to wood-framed walls only.
- (2) Applies to wood joists, wood trusses, wood I-joists and cold-formed-steel joists (C-shaped joists).
- (3) Applies to cellulose fibre:
 - (i) for wood joists, wood I-joist and wood trusses – that is sprayed-applied with a minimum density of 50 kg/m³, a minimum depth of 90 mm on the underside of the subfloor, and of 90 mm on the sides of the structural members.
 - (ii) for cold-formed-steel joists – that is spray-applied with a minimum density of 50 kg/m³ and a minimum thickness of 90 mm on the underside of the subfloor, of 90 mm on the sides of the structural members, and of 13 mm on the underside of the bottom flange other than at resilient metal channel locations.

2.3.5. Considerations for Various Types of Assemblies

- (1) Interior vertical fire separations are to be rated for exposure to fire on each side (See Sentence 3.1.3.7.(2) of Division B of the 2012 Building Code). The method described in this Subsection applies when a membrane is provided on both sides of the assembly. However, in the calculation of the fire-resistance rating of such an assembly using this method, no additional contribution to fire-resistance is to be assigned for a membrane on the non-fire-exposed side, since its contribution is already accounted for in the values assigned to the other components of the assembly.
- (2) Exterior wall assemblies required to have a fire-resistance rating are required to be rated for exposure to fire from the interior side only (See Sentence 3.1.3.7.(3) of Division B of the 2012 Building Code). When deriving a fire-resistance rating for such wall assemblies using the method described in this Subsection, only wood studs with a single layer of gypsum board or non-loadbearing cold-formed-steel studs conforming to Table 2.3.4.E. may be used. Such walls must have a membrane on the exterior side of the stud consisting of plywood, oriented strandboard or gypsum sheathing and exterior cladding. Additional materials are also permitted between the required sheathing and cladding. The spaces between the studs are to be filled with insulation conforming to CAN/ULC-S702, "Mineral Fibre Thermal Insulation for Buildings", and having a mass per unit area of not less than 1.22 kg/m² of wall surface. However, in the calculation of the fire-resistance rating of such an assembly, no additional contribution to fire resistance is to be assigned for a membrane on the non-fire-exposed side, since its contribution is already accounted for in the values assigned to the other components of the assembly.
- (3) In the case of a floor or roof assembly, the Building Code only requires testing for fire exposure from below. Floors or roofs must have an upper flooring or roofing membrane in accordance with Table 2.3.5.
- (4) Insulation used in the cavities of a wood joist or metal-plate-connected wood truss floor assembly with a single layer of gypsum board will not reduce the assigned fire-resistance rating of the assembly provided:
 - (a) the insulation is preformed of rock, slag or glass fibre conforming to CAN/ULC-S702, "Mineral Fibre Thermal Insulation for Buildings", and having a mass per unit area of not more than 1.1 kg/m² and is installed adjacent to the bottom edge of the framing member, directly above steel furring channels,
 - (b) the gypsum board ceiling membrane is attached to
 - (i) wood trusses in conformance with Sentence 2.3.9.(2) by way of steel furring channels spaced not more than 406 mm o.c., and the channels are secured to each bottom truss member with a double strand of 1.2 mm galvanized steel wire, or
 - (ii) wood joists by way of resilient metal or steel furring channels spaced not more than 406 mm o.c. in conformance with Sentences 2.3.9.(2) and (3), and
 - (c) a steel furring channel is installed midway between each furring channel mentioned in Clause (b) to provide additional support for the insulation.
- (5) Except as required in Sentence 2.3.5.(4), resilient metal or steel furring channels may be used to attach a gypsum board ceiling membrane to a floor assembly using wood joists, metal-plate-connected wood trusses and open-web steel joists, or to a roof assembly. The channels must be made of galvanized steel not less than 0.5 mm thick spaced not more than 610 mm o.c. perpendicular to the framing membranes, with an overlap of not less than 100 mm at splices and a minimum end clearance between the channels and walls of 15 mm.

Table 2.3.5.
Flooring of Roofing Membranes

Type of Assembly	Structural Members	Subfloor or Roof Deck	Finish Flooring or Roofing
Floor	Wood or open-web steel joists ⁽¹⁾ and metal-plate-connected wood trusses ⁽¹⁾	12.5 mm plywood or 15.5 mm oriented strandboard or 17 mm T & G softwood, or 14 mm phenolic-bonded Douglas Fir plywood (no finished flooring required)	Hardwood or softwood flooring on building paper Resilient flooring, parquet floor, felted synthetic fibre floor coverings, carpeting, or ceramic tile on 8 mm thick panel-type underlay Ceramic tile on 30 mm mortar bed
	Open-web steel joists ⁽¹⁾	50 mm reinforced concrete or 50 mm concrete on metal lath or formed steel sheet, or 40 mm reinforced gypsum-fibre concrete on 12.7 mm gypsum board	Finish flooring
	Wood joists, wood I-joists, wood trusses and cold-formed-steel joists	Minimum 15.5 mm T&G plywood or Minimum 15.5 mm oriented strandboard	No requirement
Roof	Wood or open-web steel joists ⁽¹⁾ and wood trusses ⁽¹⁾	12.5 mm plywood or 15.5 mm oriented strandboard or 17 mm T & G softwood, or 14 mm phenolic-bonded Douglas Fir plywood (no finished flooring required)	Finish roofing material with or without insulation
	Open-web steel joists ⁽¹⁾	50 mm reinforced concrete or 50 mm concrete on metal lath or formed steel sheet or 40 mm reinforced gypsum-fibre concrete on 12.7 mm gypsum board	Finish roofing material with or without insulation
Column 1	2	3	4

Notes to Table 2.3.5.:

(1) Applies to single layer of gypsum board membrane, and lath and plaster.

2.3.6. Framing Members

(1) The values shown in Tables 2.3.4.A., 2.3.4.B., 2.3.4.D. and 2.3.12. apply to membranes supported on framing members installed in their conventional orientation and spaced in conformance with Tables 2.3.4.E. and 2.3.4.F.

(2) Wood studs and wood roof framing members are to be not less than 38 mm by 89 mm. Wood floor joists are to be not less than 38 mm by 184 mm, except where they are used in an assembly from Table 2.3.4.D. or from Table 2.3.5. that uses a single layer of gypsum board as the lower (ceiling) membrane, in which case, wood floor joists are to be not less than 38 mm by 89 mm.

(3) Wood roof trusses are to consist of wood chord and web framing members not less than 38 mm by 89 mm and metal connector plates fabricated from galvanized steel not less than 1 mm in nominal thickness with projecting teeth not less than 8 mm long.

- (4) Wood floor trusses are to consist of:
- (a) metal-plate-connected wood trusses that are not less than 305 mm deep with wood chord and web framing members not less than 38 mm by 64 mm and metal connector plates fabricated from galvanized steel not less than 1 mm in nominal thickness with projecting teeth not less than 8 mm long,
 - (b) metal-web wood trusses that are not less than 286 mm deep with wood chords not less than 38 mm by 64 mm and V-shaped webs made from galvanized steel not less than 1 mm in nominal thickness with plate areas having projecting teeth not less than 8 mm long, or,
 - (c) fingerjoined wood trusses that are not less than 330 mm deep with fingerjoined connections, chord members not less than 38 mm by 64 mm, and web members not less than 38 mm by 38 mm glued together with a R-14 phenol-resorcinol resin conforming to CSA O112.10, "Evaluation of Adhesives for Structural Wood Products (Limited Moisture Exposure)".
- (5) Wood I-joists are to be not less than 241 mm deep with flanges that are not less than 38 mm by 38 mm and an oriented strandboard or plywood web that is not less than 9.5 mm thick.
- (6) The dimensions for dressed lumber given in CSA O141, "Softwood Lumber", are to be used for wood studs, joists, I-joists and trusses.
- (7) Cold-formed-steel studs for non-loadbearing walls are to consist of galvanized steel that is not less than 0.5 mm thick and not less than 63 mm wide, and have a flange width that is not less than 31 mm wide.
- (8) Cold-formed-steel studs in non-loadbearing wall assemblies are to be installed with not less than a 12 mm clearance between the top of the stud and the top of the runner to allow for expansion in the event of a fire. Where the studs are required to be attached for alignment purposes during erection, they must be attached to the bottom runners only.
- (9) Cold-formed-steel studs for loadbearing walls are to consist of galvanized steel that is not less than 0.912 mm thick but not greater than 1.52 mm thick, with a C-shaped cross-section not less than 92 mm deep by 41 mm wide and 12.7 mm stiffening lips.
- (10) Cold-formed-steel studs in loadbearing wall assemblies are to be installed with diagonal cross-bracing.
- (11) Cold-formed-steel floor joists (C-shaped joists) are to be not less than 41 mm wide by 203 mm deep by 1.22 mm material thickness.
- (12) The allowable spans for wood joists listed in the Span Tables in Part 9 of Division B of the Building Code are provided for floors supporting specific occupancies.

2.3.7. Plaster Finish

- (1) The thickness of plaster finish shall be measured from the face of gypsum or metal lath.

2.3.8. Edge Support for Gypsum Board in Wall Assembly

- (1) Gypsum board installed over framing or furring in a wall assembly shall be installed so that all edges are supported, except that 15.9 mm Type X gypsum board may be installed horizontally with the horizontal joints unsupported when framing members are at 406 mm o.c. maximum.

2.3.9. Membrane Fastening

- (1) Except as provided in Sentences (2) to (5), Table 2.3.4.B. and Sentence 2.3.5.(5), the application of lath and plaster finish shall conform to CSA A82.30-M, "Interior Furring, Lathing and Gypsum Plastering", and of gypsum board finish shall conform to ASTM C840, "Application and Finishing of Gypsum Board".
- (2) Where a membrane referred to in Table 2.3.4.A., 2.3.4.B., 2.3.4.C., 2.3.4.D. or 2.3.12. is applied to steel framing or furring, fasteners shall penetrate not less than 10 mm through the metal.

(3) Except as provided in Sentence (4), where a membrane referred to in Table 2.3.4.A., 2.3.4.B., 2.3.4.C., 2.3.4.D. or 2.3.12. is applied to wood framing or furring, minimum fastener penetrations into wood members shall conform to Table 2.3.9. for the time assigned to the membrane.

(4) Where a membrane is applied in 2 layers, the fastener penetrations described in Table 2.3.9. shall apply to the base layer. Fasteners for the face layer shall penetrate not less than 20 mm into wood supports.

(5) In a double layer application of gypsum board on wood supports, fastener spacing shall conform to ASTM C840, "Application and Finishing of Gypsum Board".

Table 2.3.9.
Membrane Fastening

Type of Membrane	Minimum Penetration of Fasteners for Membrane Protection on Wood Framing, mm					
	5 – 25	30 – 35	40	50	55 – 70	80
	Time, ⁽¹⁾ min					
Single layer	20	29	32	—	—	—
Double layer	20	20	20	29	35	44
Gypsum lath	20	20	23	23	29	29
Column 1	2	3	4	5	6	7

Notes to Table 2.3.9.:

(1) Assigned contributions of membranes to fire resistance are listed in Tables 2.3.4.A., 2.3.4.B., 2.3.4.C., 2.3.4.D. and 2.3.12.

2.3.10. Ceiling Membrane Openings - Combustible Construction

(1) Except as permitted in Article 2.3.12., where a floor or roof assembly of combustible construction is assigned a fire-resistance rating on the basis of this Subsection and incorporates a ceiling membrane described in Table 2.3.4.B., 2.3.4.C. or 2.3.4.D., the ceiling membrane may be penetrated by openings leading to ducts within concealed spaces above the membrane provided:

- (a) the assembly is not required to have a fire-resistance rating in excess of 1 h,
- (b) the area of any openings does not exceed 930 cm² (see Sentence (2)),
- (c) the aggregate area of openings does not exceed 1% of the ceiling area of the fire compartment,
- (d) the depth of the concealed space above the ceiling is not less than 230 mm,
- (e) no dimension of any opening exceeds 310 mm,
- (f) supports are provided for openings with any dimension exceeding 150 mm where framing members are spaced greater than 406 mm o.c.,
- (g) individual openings are spaced not less than 2 m apart,
- (h) the ducts above the membrane are sheet steel and are supported by steel strapping firmly attached to the framing members, and
- (i) the clearance between the top surface of the membrane and the bottom surface of the ducts is not less than 100 mm.

- (2) Where an individual opening permitted in Sentence (1) exceeds 130 cm² in area, it shall be protected by
 - (a) a fire stop flap conforming to CAN/ULC-S112.2, "Fire Test of Ceiling Firestop Flap Assemblies", that activates at a temperature approximately 30°C above the normal maximum temperature that occurs in the ducts, whether the air duct system is operating or shut down, or
 - (b) thermal protection above the duct consisting of the same materials as used for the ceiling membrane, mechanically fastened to the ductwork and extending 200 mm beyond the opening on all sides (see Figure 2.3.10.).

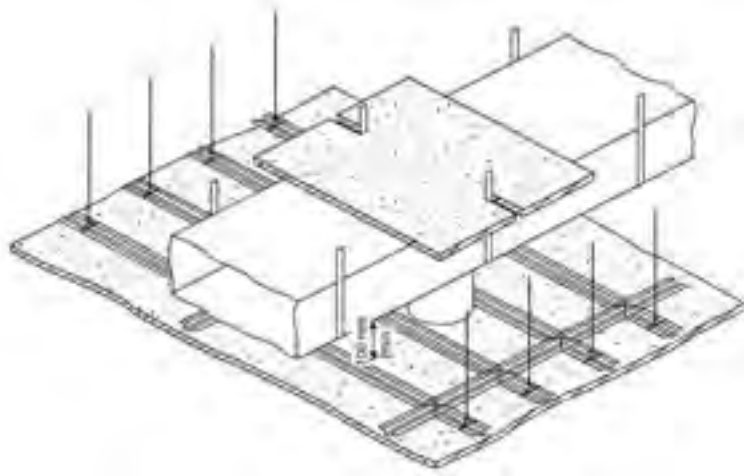


Figure 2.3.10.
Thermal Protection Above a Duct

2.3.11. Ceiling Membrane Openings - Noncombustible Construction

(1) Except as permitted in Article 2.3.12., where a floor or roof assembly of noncombustible construction is assigned a fire-resistance rating on the basis of this Subsection and incorporates a ceiling membrane described in Table 2.3.4.B., 2.3.4.C. or 2.3.4.D. the ceiling membrane may be penetrated by openings leading to ducts located within concealed spaces provided:

- (a) the area of any opening does not exceed 930 cm² (see Sentence (2)),
- (b) the aggregate area of openings does not exceed 2% of the ceiling area of the fire compartment,
- (c) no dimension of any opening exceeds 400 mm,
- (d) individual openings are spaced not less than 2 m apart,
- (e) openings are located not less than 200 mm from major structural members such as beams, columns or joists,
- (f) the ducts above the membrane are sheet steel and are supported by steel strapping firmly attached to the framing members, and
- (g) the clearance between the top surface of the membrane and the bottom surface of the duct is not less than 100 mm.

(2) Where an individual opening permitted in Sentence (1) exceeds 130 cm² in area, it shall be protected by

- (a) a fire stop flap conforming to CAN/ULC-S112.2, "Fire Test of Ceiling Firestop Flap Assemblies", that activates at a temperature approximately 30°C above the normal maximum temperature that occurs in the ducts, whether the air duct system is operating or shut down, or
- (b) thermal protection above the duct consisting of the same materials as used for the ceiling membrane, mechanically fastened to the ductwork and extending 200 mm beyond the opening on all sides (see Figure 2.3.10.).

2.3.12. Ceiling Membrane Rating

(1) Where the fire-resistance rating of a ceiling assembly is to be determined on the basis of the membrane only and not of the complete assembly, the ratings may be determined from Table 2.3.12., provided no openings described in Articles 2.3.10. and 2.3.11. are located within the ceiling membrane.

Table 2.3.12.
Fire-Resistance Rating for Ceiling Membranes

Description of Membrane	Fire-Resistance Rating, min
15.9 mm Type X gypsum board with ≥ 75 mm mineral wool batt insulation above board	30
19 mm gypsum-sand plaster on metal lath	30
Double 14.0 mm Douglas Fir plywood phenolic bonded	30
Double 12.7 mm Type X gypsum board	45
25 mm gypsum-sand plaster on metal lath	45
Double 15.9 mm Type X gypsum board	60
32 mm gypsum-sand plaster on metal lath	60
Column 1	2

2.3.13. Membrane Penetrations in Combustible and Noncombustible Construction

(1) Where a wall, floor or roof assembly is assigned a fire-resistance rating on the basis of this Subsection and includes a membrane or membranes described in Table 2.3.4.A., 2.3.4.B., 2.3.4.C., 2.3.4.D. or 2.3.12., penetrations of the membrane or membranes must be fire stopped in conformance with the applicable requirements in Article 3.1.9.1. or Sentence 9.10.9.6.(1) of Division B of the Building Code.

2.3.14. Beams

(1) Where a steel beam is included with an open-web steel joist and is protected by the same continuous ceiling, the beam is assumed to have a fire-resistance rating equal to that assigned to the rest of the assembly.

(2) The ratings in this Subsection assume that the construction to which the beam is related is a normal one and does not carry unusual loads from the floor or slab above.

2.3.15. Wired Glass Assembly Support

(1) Openings in a vertical fire separation having a fire-resistance rating of not more than 1 h are allowed to be protected by wired glass assemblies, provided the wired glass is

- (a) not less than 6 mm thick,
- (b) reinforced by a steel wire mesh in the form of diamonds, squares or hexagons having dimensions of
 - (i) approximately 25 mm across the flats, using wire of not less than 0.45 mm diameter, or
 - (ii) approximately 13 mm across the flats, using wire of not less than 0.40 mm diameter, the wire to be centrally embedded during manufacture and welded or intertwined at each intersection,
- (c) set in fixed steel frames with metal not less than 1.35 mm thick and providing a glazing stop of not less than 20 mm on each side of the glass, and
- (d) limited in area so that
 - (i) individual panes are not more than 0.84 m², with neither height nor width more than 1.4 m, and
 - (ii) the area not structurally supported by mullions is not more than 7.5 m².

(2) It is intended that the structural mullions referred to in Subclause (1)(d)(ii) will not distort or be displaced to the extent that there would be a failure of the wired glass closure during the period for which a closure in the fire separation would be expected to function. Hollow structural steel tubing not less than 100 mm square filled with a Portland cement-based grout will satisfy the intent of the Subclause.

2.4. Solid Wood Walls, Floors and Roofs

2.4.1. Minimum Thickness

(1) The minimum thickness of solid wood walls, floors and roofs for fire-resistance ratings from 30 min to 1.5 h is shown in Table 2.4.1.

Table 2.4.1.
Minimum Thickness of Solid Wood Walls, Roofs and Floors,⁽¹⁾⁽²⁾ mm

Type of Construction	Fire-Resistance Rating			
	30 min	45 min	1 h	1.5 h
Solid wood floor with building paper and finish flooring on top ⁽³⁾	89	114	165	235
Solid wood, splined or tongued and grooved floor with building paper and finish flooring on top ⁽⁴⁾	64	76	—	—
Solid wood walls of loadbearing vertical plank ⁽³⁾	89	114	140	184
Solid wood walls of non-loadbearing horizontal plank ⁽³⁾	89	89	89	140
Column 1	2	3	4	5

Notes to Table 2.4.1.:

- (1) See CSA O141, "Softwood Lumber", for sizes.
- (2) The fire-resistance ratings and minimum dimensions for floors also apply to solid wood roof decks of comparable thickness with finish roofing material.
- (3) The assembly shall consist of 38 mm thick members on edge fastened together with 101 mm common wire nails spaced not more than 406 mm o.c. and staggered in the direction of the grain.
- (4) The floor shall consist of 64 mm by 184 mm wide planks either tongued and grooved or with 19 mm by 38 mm splines set in grooves and fastened together with 88 mm common nails spaced not more than 406 mm o.c.

2.4.2. Increased Fire-Resistance Rating

(1) The fire-resistance rating of the assemblies described in Table 2.4.1. may be increased by 15 min if one of the following finishes is applied on the fire-exposed side:

- (a) 12.7 mm thick gypsum board,
- (b) 20 mm thick gypsum-sand plaster on metal lath, or
- (c) 13 mm thick gypsum-sand plaster on 9.5 mm gypsum lath.

(2) Fastening of the plaster to the wood structure shall conform to Subsection 2.3.

2.4.3. Supplementary Ratings

(1) Supplementary ratings based on tests are included in Table 2.4.3. The ratings given shall apply to construction that conform in all details with the descriptions given.

Table 2.4.3.
Fire-Resistance Rating of Non-Loadbearing Built-up Solid Wood Partitions⁽¹⁾

Construction Details	Actual Overall Thickness, mm	Fire-Resistance Rating
Solid panels of wood boards 64 mm to 140 mm wide grooved and joined with wood splines, nailed together, boards placed vertically with staggered joints, 3 boards thick	58	30 min
Solid panels with 4 mm plywood facings ⁽²⁾ glued to 46 mm solid wood core of glued, tongued and grooved construction for both sides and ends of core pieces with tongued and grooved rails in the core about 760 mm apart	54	1 h
Column 1	2	3

Notes to Table 2.4.3.:

- (1) The ratings and notes are taken from "Fire Resistance Classifications of Building Constructions", Building Materials and Structures Report BMS 92, National Bureau of Standards, Washington, 1942.
- (2) Ratings for plywood faced panel are based on phenolic resin glue being used for gluing facings to wood frames. If other types of glue are used for this purpose, the ratings apply if the facings are nailed to the frames in addition to being glued.

2.5. Solid Plaster Partitions

2.5.1. Minimum Thickness

- (1) The minimum thickness of solid plaster partitions for fire-resistance ratings from 30 min to 4 h is shown in Table 2.5.1.

Table 2.5.1.
Minimum Thickness of Non-Loadbearing Solid Plaster Partitions, mm

Type of Plaster on Metal Lath ⁽¹⁾	Fire-Resistance Rating						
	30 min	45 min	1 h	1.5 h	2 h	3 h	4 h
Portland cement-sand ⁽²⁾ or Portland cement-lime-sand	50 ⁽³⁾	—	—	—	—	—	—
Gypsum-sand	50 ⁽³⁾	50 ⁽³⁾	64	—	—	—	—
Gypsum-vermiculite, gypsum-perlite, Portland cement-vermiculite or Portland cement-perlite	50 ⁽³⁾	50 ⁽³⁾	50 ⁽³⁾	58	64	83	102
Column 1	2	3	4	5	6	7	8

Notes to Table 2.5.1.:

- (1) Metal lath shall be expanded metal lath or welded woven wire fabric supported on 19 mm vertical light steel studs spaced not more than 610 mm o.c. Plaster shall be applied to both sides of the lath.
- (2) For mixture of Portland cement-sand plaster, see Sentence 1.7.2.(2).
- (3) CSA A82.30-M, "Interior Furring, Lathing and Gypsum Plastering", does not permit solid plaster partitions less than 50 mm thick.

2.6. Protected Steel Columns

2.6.1. Minimum Thickness of Protective Covering

(1) The minimum thickness of protective covering to steel columns is shown in Tables 2.6.1.A. to 2.6.1.F. for fire-resistance ratings from 30 min to 4 h.

Table 2.6.1.A.
Minimum Thickness of Concrete or Masonry Protection to Steel Columns, mm

Description of Cover	Fire-Resistance Rating						
	30 min	45 min	1 h	1.5 h	2 h	3 h	4 h
Monolithic concrete							
Type S concrete ⁽¹⁾ (column spaces filled) ⁽²⁾	25	25	25	25	39	64	89
Type N or L concrete ⁽¹⁾ (column spaces filled) ⁽²⁾	25	25	25	25	32	50	77
Concrete masonry units ⁽³⁾ or precast reinforced concrete units							
Type S concrete (column spaces not filled)	50	50	50	50	64	89	115
Type N or L concrete (column spaces not filled)	50	50	50	50	50	77	102
Clay or shale brick ⁽⁴⁾ (column spaces filled) ⁽²⁾	50	50	50	50	50	64	77
Clay or shale brick ⁽⁴⁾ (column spaces not filled)	50	50	50	50	50	77	102
Hollow clay tile ⁽⁵⁾ (column spaces filled) ⁽²⁾	50 ⁽⁶⁾	50 ⁽⁶⁾	50 ⁽⁶⁾	50 ⁽⁶⁾	⁽⁷⁾	⁽⁷⁾	⁽⁷⁾
Hollow clay tile ⁽⁵⁾ (column spaces not filled)	50 ⁽⁶⁾	50 ⁽⁶⁾	50 ⁽⁶⁾	—	—	—	—
Column 1	2	3	4	5	6	7	8

Notes to Table 2.6.1.A.:

- (1) Applies to cast-in-place concrete reinforced with 5.21 mm diam wire wrapped around column spirally 200 mm o.c., or 1.57 mm diam wire mesh with 100 mm by 100 mm openings.
- (2) The space between the protective covering and the web or flange of the column shall be filled with concrete, cement mortar or a mixture of cement mortar and broken bricks.
- (3) Concrete masonry shall be reinforced with 5.21 mm diam wire or wire mesh with 1.19 mm diam wire and 10 mm by 10 mm openings, laid in every second course.
- (4) Brick cover 77 mm thick or less shall be reinforced with 2.34 mm diam wire or 1.19 mm diam wire mesh with 10 mm by 10 mm openings, laid in every second course.
- (5) Hollow clay tiles and masonry mortar shall be reinforced with 1.19 mm diam wire mesh with 10 mm by 10 mm openings, laid in every horizontal joint and lapped at corners.
- (6) Hollow clay tiles shall conform to CAN/CSA-A82, "Fired Masonry Brick Made from Clay or Shale".
- (7) 50 mm nominal hollow clay tile, reinforced with 1.19 mm diam wire mesh with 10 mm by 10 mm openings laid in every horizontal joint and covered with 19 mm gypsum-sand plaster and with limestone concrete fill in column spaces, has a 4 h fire-resistance rating.

Table 2.6.1.B.
Minimum Thickness of Plaster Protection to Steel Columns, mm

Description	Fire-Resistance Rating ⁽¹⁾⁽²⁾						
	30 min	45 min	1 h	1.5 h	2 h	3 h	4 h
Gypsum-sand plaster on 9.5 mm gypsum lath ⁽³⁾	13	13	13	20	—	—	—
Gypsum-perlite or vermiculite plaster on 9.5 mm gypsum lath ⁽³⁾	13	13	13	20	25	—	—
Gypsum perlite or vermiculite plaster on 12.7 mm gypsum lath ⁽³⁾	13	13	13	20	25	32	50
Gypsum perlite or vermiculite plaster on double 12.7 mm gypsum lath ⁽³⁾	13	13	13	20	25	25	32
Portland cement-sand plaster on metal lath ⁽⁴⁾⁽⁵⁾	25	25	25	—	—	—	—
Column 1	2	3	4	5	6	7	8

Notes to Table 2.6.1.B.:

- (1) Fire-resistance ratings of 30 min and 45 min apply to columns whose M/D ratio is 30 or greater. Fire-resistance ratings greater than 45 min apply to columns whose M/D ratio is greater than 60. Where the M/D ratio is between 30 and 60 and the required fire-resistance rating is greater than 45 min, the total thickness of protection specified in the Table shall be increased by 50%. (To determine M/D, refer to Article 2.6.4.)
- (2) Where the thickness of plaster over gypsum lath is 25 mm or more, wire mesh with 1.57 mm diam wire and openings not exceeding 50 mm by 50 mm shall be placed midway in the plaster.
- (3) Lath held in place by 1.19 mm diam wire wrapped around lath 450 mm o.c.
- (4) Expanded metal lath 1.36 kg/m² fastened to 9.5 mm by 19 mm steel channels held in vertical position around column by 1.19 mm diam wire ties.
- (5) For mixture of Portland cement-sand plaster, see Sentence 1.7.2.(2).

Table 2.6.1.C.
Minimum Thickness of Gypsum-Sand Plaster on Metal Lath Protection to Steel Columns, mm

M/D ⁽¹⁾	Fire-Resistance Rating					
	30 min	45 min	1 h	1.5 h	2 h	3 h
30 to 60	16	16	32	—	—	—
over 60 to 90	16	16	16	32	—	—
over 90 to 120	16	16	16	25	39	—
over 120 to 180	16	16	16	16	25	—
over 180	16	16	16	16	25	39
Column 1	2	3	4	5	6	7

Notes to Table 2.6.1.C.:

- (1) To determine the M/D ratio, refer to Article 2.6.4.

Table 2.6.1.D.
Minimum Thickness of Gypsum-Perlite or Gypsum-Vermiculite Plaster on Metal Lath Protection to Steel Columns, mm

M/D ⁽¹⁾	Fire-Resistance Rating						
	30 min	45 min	1 h	1.5 h	2 h	3 h	4 h
30 to 60	16	16	20	32	35	—	—
over 60 to 90	16	16	16	20	26	35	45
over 90 to 120	16	16	16	16	26	35	45
over 120 to 180	16	16	16	16	20	32	35
over 180	16	16	16	16	16	26	35
Column 1	2	3	4	5	6	7	8

Notes to Table 2.6.1.D.:

(1) To determine the M/D ratio, refer to Article 2.6.4.

Table 2.6.1.E.
Steel Columns with Sheet-Steel Membrane and Insulation as Shown in Figures 2.6.1.A. and 2.6.1.B.

Type of Protection	Steel Thickness, ⁽¹⁾ mm	Fastening ⁽²⁾	Insulation	Fire-Resistance Rating
See Figure 2.6.1.A.	0.51	No. 8 sheet-metal screws 9.5 mm long, 200 mm o.c.	50 mm mineral wool batts ⁽³⁾	45 min
See Figure 2.6.1.B.	0.64	Self-threading screws or No. 8 sheet-metal screws, 600 mm o.c.	2 layers 12.7 mm gypsum board	1.5 h
See Figure 2.6.1.A.	0.64	No. 8 sheet-metal screws, 9.5 mm long, 200 mm o.c.	75 mm mineral wool batts, ⁽³⁾ 12.7 mm gypsum board	2 h
See Figure 2.6.1.B.	0.76	Crimped joint or No. 8 sheet-metal screws, 300 mm o.c.	2 layers 15.9 mm gypsum board	2 h
Column 1	2	3	4	5

Notes to Table 2.6.1.E.:

- (1) Minimum thickness, galvanized or wiped-zinc-coated sheet-steel.
- (2) Sheet-steel shall be securely fastened to the floor and superstructure, or where sheet-steel cover does not extend floor to floor, fire stopping shall be provided at the level where sheet-steel protection ends. In the latter case, an alternate type of fire protection shall be applied between the fire stopping and the superstructure.
- (3) Conforming to CAN/ULC-S702, "Mineral Fibre Thermal Insulation for Buildings", Type 1A, minimum density 30 kg/m³: column section and batts wrapped with 25 mm mesh chicken wire.

Table 2.6.1.F.
Minimum M/D Ratio for Steel Columns Covered With Type X Gypsum Board Protection⁽¹⁾

Minimum Thickness of Type X Gypsum Board Protection ⁽²⁾ , mm	Fire-Resistance Rating			
	1 h	1.5 h	2 h	3 h
12.7	75	—	—	—
15.9	55	—	—	—
25.4	35	60	—	—
28.6	35	50	—	—
31.8	35	40	75	—
38.1	35	35	55	—
41.3	35	35	45	—
44.5	35	35	35	—
47.6	35	35	35	—
50.8	35	35	35	75
63.5	35	35	35	45
Column 1	2	3	4	5

Notes to Table 2.6.1.F.:

- (1) To determine the M/D ratio, refer to Article 2.6.4.
(2) See Article 2.6.5.

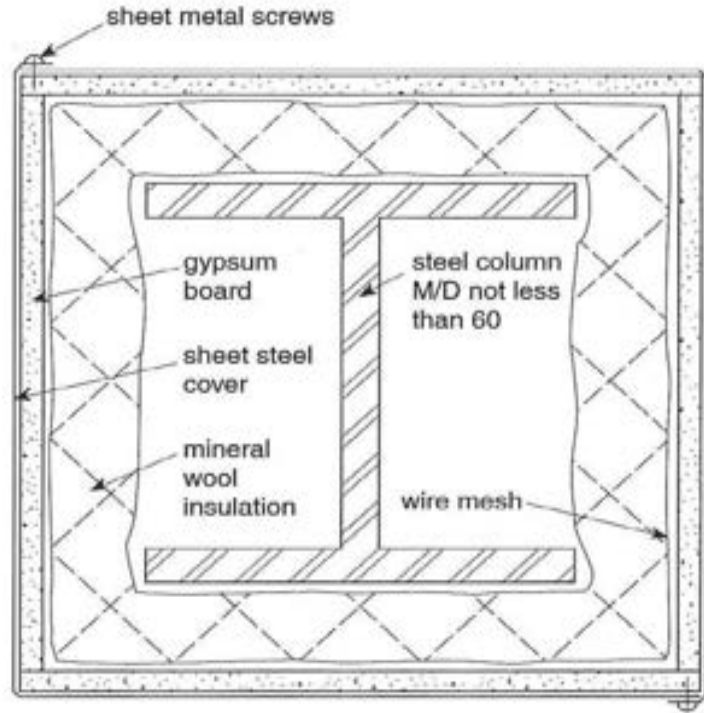


Figure 2.6.1.A.
Column Protected by Sheet-Steel Membrane, Gypsum Board and Mineral-Wool Insulation

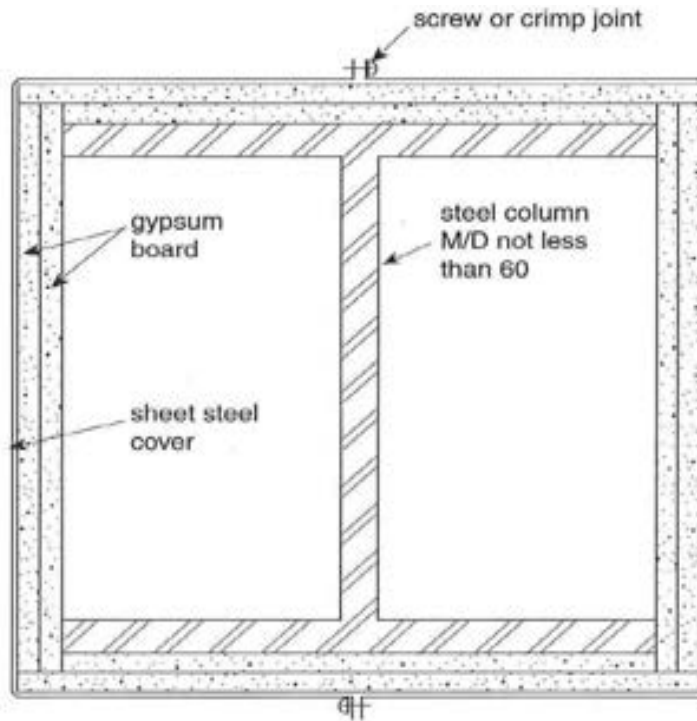


Figure 2.6.1.B.
Column Protected by Sheet-Steel Membrane and Gypsum Board

2.6.2. Hollow Unit Masonry Columns

(1) For hollow-unit masonry column protection, the thickness shown in Tables 2.6.1.A. to 2.6.1.D. is the equivalent thickness as described in Subsection 1.6.

2.6.3. Effect of Plaster

(1) The effect on fire-resistance ratings of the addition of plaster to masonry and monolithic concrete column protection is described in Subsection 1.7.

2.6.4. Determination of M/D Ratio

(1) The ratio M/D to which reference is made in Tables 2.6.1.B., 2.6.1.C., 2.6.1.D. and 2.6.1.F. shall be found by dividing "M," the mass of the column in kilograms per metre by "D," the heated perimeter of the steel column section in metres.

(2) The heated perimeter "D" of steel columns, shown as the dashed line in Figure 2.6.4.A., shall be equal to $2(B+H)$ in Examples (1) and (2), and $3.14B$ in Example (3). In Figure 2.6.4.B., the heated perimeter "D" shall be equal to $2(B+H)$.

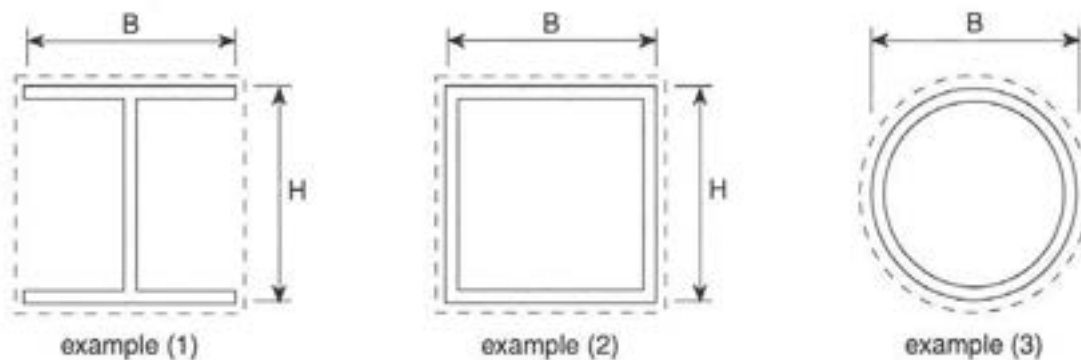


Figure 2.6.4.A.
 Example (1), Standard or Wide-Flange Beam,
 Example (2), Hollow Structural Section (Rectangular or Square),
 Example (3), Hollow Structural Section (Round)

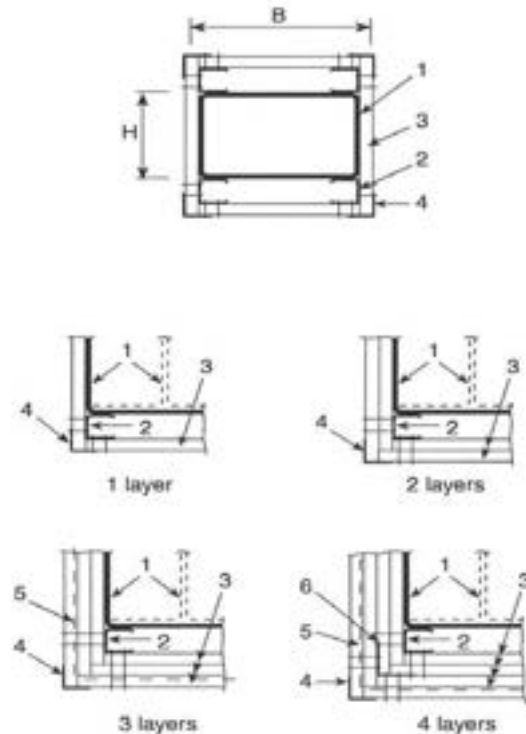


Figure 2.6.4.B.
Columns Protected by Type X Gypsum Board Without Sheet-Steel Membrane

2.6.5. Attachment of Gypsum Board

- (1) Where Type X gypsum board is used to protect a steel column without an outside sheet-steel membrane, the method of gypsum board attachment to the column shall be as shown in Figure 2.6.4.B. and shall meet the construction details described in Sentences (2) to (7).
- (2) The Type X gypsum board shall be applied vertically without horizontal joints.
- (3) The first layer of gypsum board shall be attached to steel studs with screws spaced not more than 610 mm o.c. and other layers of gypsum board shall be attached to steel studs and steel corner beads with screws spaced at a maximum of 305 mm o.c. Where a single layer of gypsum board is used, attachment screws shall be spaced not more than 305 mm o.c.
- (4) Steel tie wires spaced at a maximum of 610 mm o.c. shall be used to secure the second last layer of gypsum board in 3- and 4-layer systems.
- (5) Studs shall be fabricated of galvanized steel not less than 0.53 mm thick and not less than 41.3 mm wide, with legs not less than 33.3 mm long and shall be 12.7 mm less than the assembly height.
- (6) Corner beads shall
 - (a) be fabricated of galvanized steel that is not less than 0.41 mm thick,

- (b) have legs not less than 31 mm long,
 - (c) be attached to the gypsum board or stud with 25.4 mm screws spaced not more than 305 mm o.c., and
 - (d) have the attaching fasteners penetrate either another corner bead in multiple layer assemblies or the steel stud member.
- (7) In a 4-layer system, metal angles shall be fabricated of galvanized steel and shall be not less than 0.46 mm thick with legs not less than 51 mm long.

2.6.6. Concrete Filled Hollow Steel Columns

(1) A fire-resistance rating, R, is permitted to be assigned to concentrically loaded hollow steel columns that are filled with plain concrete, steel-fibre reinforced concrete or bar-reinforced concrete, that are fabricated and erected within the tolerances stipulated in CSA S16, "Design of Steel Structures", and that comply with Sentences (2) and (3), provided:

$$C \leq C_{\max}$$

where

C = axial compressive force due to dead and live loads without load factors, kN,

$$C_{\max} = \left(\frac{a (f'_c + 20) D^{2.5}}{R (KL - 1000)} \right)^2$$

but shall not exceed

- 1.0 C'_r for plain concrete filling (PC),
- 1.1 C'_r for steel-fibre reinforced concrete filling (FC), and
- 1.7 C'_r for bar-reinforced concrete filling (RC),

where

$$C'_r = 0.85 \phi_c f'_c A_c \lambda_c^{-2} \left[\sqrt{1 + 0.25 \lambda_c^{-4}} - 0.5 \lambda_c^{-2} \right]$$

where

a = constant obtained from Table 2.6.6.A.,

f'_c = specified compressive strength of concrete in accordance with CSA A23.3, "Design of Concrete Structures", MPa,

r_c = radius of gyration of the concrete area,

A_c = area of concrete, mm²,

D = outside diameter of a round column or outside width of a square column, mm,

E_c = initial elastic modulus for concrete, considering the effects of long-term load for normal-weight concrete = $\left(1 + \frac{S}{T}\right) 2500 \sqrt{f'_c}$, where f'_c is expressed in MPa, S is the short-term load, and T is the total load on the column,

R = specified fire-resistance rating, min,

KL = effective length of column as defined in CSA S16, "Design of Steel Structures", mm,

$$\lambda_c = \frac{KL}{r_c} \sqrt{\frac{f'_c}{\pi^2 E_c}}, \text{ and}$$

$$\phi_c = 0.60$$

subject to the validity limits specified in Table 2.6.6.B.

- (2) A pair of steam vent holes shall be provided at each end of the hollow steel column and at each intermediate floor level, and the holes shall be
- not less than 13 mm in diameter,
 - located on opposite faces, 150 mm above or below a base plate, cap plate or concrete slab,
 - orientated so that adjacent pairs are perpendicular, and
 - not obstructed by other building elements.
- (3) Load application and reaction shall be through end bearing in accordance with CSA S16, "Design of Steel Structures".

Table 2.6.6.A.
Values of Constant "a"

Filling Type	Concrete Type ⁽¹⁾	Steel Reinforcement	Circular Columns	Square Columns
PC	S	n/a	0.070	0.060
FC	S	≈ 2%	0.075	0.065
RC	S	1.5% – 3%	0.080	0.070
RC	S	3% – 5%	0.085	0.075
PC	N	n/a	0.080	0.070
FC	N	≈ 2%	0.085	0.075
RC	N	1.5% – 3%	0.090	0.080
RC	N	3% – 5%	0.095	0.085
Column 1	2	3	4	5

Notes to Table 2.6.6.A.:

- (1) See Subsection 1.4.

Table 2.6.6.B.
Validity Limits

Parameter	Type of Concrete Filling		
	PC	FC	RC
f'_c (MPa)	20 to 40	20 to 55	20 to 55
D (round) (mm)	140 to 410	120 to 410	165 to 410
D (square) (mm)	140 to 305	102 to 305	175 to 305
Reinforcement (%)	n/a	≈ 2% of the concrete mix by mass	1.5% to 5% of cross-sectional area ⁽¹⁾
Concrete Cover (mm)	n/a	n/a	≥ 25
R (min)	≤ 120	≤ 180	≤ 180
KL (mm)	2 000 to 4 000	2 000 to 4 500	2 000 to 4 500
Class ⁽²⁾	1, 2 or 3	1, 2 or 3	1, 2 or 3
Column 1	2	3	4

Notes to Table 2.6.6.B.:

- (1) Limits on size, number and spacing of bars and ties in accordance with CSA A23.3, "Design of Concrete Structures".
 (2) Classification of sections in accordance with CSA S16, "Design of Steel Structures".

2.7. Individually Protected Steel Beams

2.7.1. Minimum Thickness of Protective Covering

(1) The minimum thickness of protective covering on steel beams exposed to fire on 3 sides for fire-resistance ratings from 30 min to 4 h is shown in Table 2.7.1.

Table 2.7.1.
Minimum Thickness of Cover to Individual Protected Steel Beams,⁽¹⁾ mm

Description of Cover	Fire-Resistance Rating						
	30 min	45 min	1 h	1.5	2 h	3 h	4 h
Type S concrete ⁽²⁾ (beam spaces filled solid)	25	25	25	25	32	50	64
Type N or L concrete ⁽²⁾ (beam spaces filled solid)	25	25	25	25	25	39	50
Gypsum-sand plaster on 9.5 mm gypsum lath ⁽³⁾	13	13	13	20	—	—	—
Gypsum-perlite or vermiculite plaster on 9.5 mm gypsum lath ⁽³⁾	13	13	13	13	25	—	—
Gypsum-perlite or gypsum-vermiculite on 12.7 mm gypsum lath ⁽³⁾	13	13	13	20	25	39	50
Gypsum-perlite or vermiculite plaster on double 12.7 mm gypsum lath ⁽³⁾	13	13	13	20	25	25	39
Portland cement-sand on metal lath ⁽⁴⁾	23	23	23	—	—	—	—
Gypsum-sand on metal lath ⁽⁴⁾ (plaster in contact with lower flange)	16	20	25	39	—	—	—
Gypsum-sand on metal lath with air gap between plaster and lower flange ⁽⁴⁾	16	16	16	25	25	—	—
Gypsum-perlite or gypsum-vermiculite on metal lath ⁽⁴⁾	16	16	16	23	23	35	48 ⁽⁵⁾
Column 1	2	3	4	5	6	7	8

Notes to Table 2.7.1.:

- (1) Where the thickness of plaster finish applied over gypsum lath is 26 mm or more, the plaster shall be reinforced with wire mesh with 1.57 mm diam wire and 50 mm by 50 mm openings placed midway in the plaster.
- (2) Applies to cast-in-place concrete reinforced by 5.21 mm diam wire spaced 200 mm o.c. or 1.57 mm diam wire mesh with 100 mm by 100 mm openings.
- (3) Lath held in place by 1.18 mm diam wire wrapped around the gypsum lath 450 mm o.c.
- (4) Expanded metal lath 1.63 kg/m² fastened to 9.5 mm by 19 mm steel channels held in position by 1.19 mm diam wire.
- (5) Plaster finish shall be reinforced with wire mesh with 1.57 mm diam wire and 50 mm by 50 mm openings placed midway in the plaster.

2.7.2. Types of Concrete

(1) Concrete is referred to as Type S, N or L, depending on the nature of the aggregate used. This is described in Article 1.4.1.

2.7.3. Effect of Plaster

(1) The effect on fire-resistance ratings of the addition of plaster finish to concrete or masonry beam protection is described in Article 1.7.1.

2.7.4. Exceptions

(1) The fire resistance of protected steel beams depends on the means used to hold the protection in place. Because of the importance of this factor, no rating has been assigned in Table 2.7.1. to masonry units used as protective cover to steel beams. These ratings, however, may be determined on the basis of comparison with column protection at the discretion of the authority having jurisdiction, if satisfactory means of fastening are provided.

2.7.5. Beam Protected by a Membrane

(1) A steel beam or steel joist assembly that is entirely above a horizontal ceiling membrane will be protected from fire below the membrane and will resist structural collapse for a period equal to the fire-resistance rating determined in conformance with Subsection 2.3. The support for this membrane shall be equivalent to that described in Subsection 2.3. The rating on this basis shall not exceed 1.5 h.

2.8. Reinforced Concrete Columns

2.8.1. Minimum Dimensions

(1) Minimum dimensions for reinforced concrete columns and minimum concrete cover for vertical steel reinforcement are obtained from Articles 2.8.2. to 2.8.5., taking into account the type of concrete, the effective length of the column and the area of the vertical reinforcement.

2.8.2. Method

- (1) The minimum dimension, t , in millimetres, of a rectangular reinforced concrete column shall be equal to
- 75 $f (R + 1)$ for all Types L and L40S concrete,
 - 80 $f (R + 1)$ for Type S concrete when the design condition of the concrete column is defined in the second and fourth columns of Table 2.8.2.,
 - 80 $f (R + 0.75)$ for Type N concrete when the design condition of the concrete column is defined in the second and fourth columns of Table 2.8.2., and
 - 100 $f (R + 1)$ for Types S and N concrete when the design condition of the concrete column is defined in the third column of Table 2.8.2.

where

f = the value shown in Table 2.8.2.,

R = the required fire-resistance rating in hours,

k = the effective length factor obtained from CSA A23.3, "Design of Concrete Structures",

h = the unsupported length of the column in metres, and

p = the area of vertical reinforcement in the column as a percentage of the column area.

(2) The diameter of a round column shall be not less than 1.2 times the value " t " determined in Sentence (1) for a rectangular column.

Table 2.8.2.
Values of Factor "f"⁽¹⁾

Overdesign Factor ⁽²⁾	Values of Factor f to be Used in Applying Article 2.8.2.		
	Where kh is not more than 3.7 m	Where kh is more than 3.7 m but not more than 7.3 m	
		t is not more than 300 mm, p is not more than 3% ⁽³⁾	All other cases ⁽⁴⁾
1.00	1.00	1.20	1.00
1.25	0.90	1.10	0.90
1.50	0.83	1.00	0.83
Column 1	2	3	4

Notes to Table 2.8.2.:

- (1) For conditions that do not fall within the limits described in Table 2.8.2., further information may be obtained from Reference (7) in Subsection 6.1.
- (2) Overdesign factor is the ratio of the calculated load carrying capacity of the column to the column strength required to carry the specified loads determined in conformance with CSA A23.3, "Design of Concrete Structures".
- (3) Where the factor "f" results in a "t" greater than 300 mm, the appropriate factor "f" for "All other cases" shall be applicable.
- (4) Where "p" is equal to or less than 3% and the factor "f" results in a "t" less than 300 mm, the minimum thickness shall be 300 mm.

2.8.3. Minimum Thickness of Concrete Cover

- (1) Where the required fire-resistance rating of a concrete column is 3 h or less, the minimum thickness in millimetres of concrete cover over vertical steel reinforcement shall be equal to 25 times the number of hours of fire resistance required or 50 mm, whichever is less.
- (2) Where the required fire-resistance rating of a concrete column is greater than 3 h, the minimum thickness in millimetres of concrete cover over vertical steel reinforcement shall be equal to 50 plus 12.5 times the required number of hours of fire resistance in excess of 3 h.
- (3) Where the concrete cover over vertical steel required in Sentence (2) exceeds 62.5 mm, wire mesh reinforcement with 1.57 mm diameter wire and 100 mm openings shall be incorporated midway in the concrete cover to retain the concrete in position.

2.8.4. Minimum Requirements

- (1) The structural design standards may require minimum column dimensions or concrete cover over vertical steel reinforcement differing from those obtained in Sentences 2.8.2.(1) and (2). Where a difference occurs, the greater dimension shall govern.

2.8.5. Addition of Plaster

- (1) The addition of plaster finish to the concrete column may be taken into account in determining the cover over vertical steel reinforcement by applying the multiplying factors described in Subsection 1.7. The addition of plaster shall not, however, justify any decrease in the minimum column sizes shown.

2.8.6. Built-in Columns

(1) The fire-resistance rating of a reinforced concrete column that is built into a masonry or concrete wall so that not more than one face may be exposed to the possibility of fire at one time may be determined on the basis of cover to vertical reinforcing steel alone. In order to meet this condition, the wall shall conform to Subsection 2.1. for the fire-resistance rating required.

2.9. Reinforced Concrete Beams

2.9.1. Minimum Cover Thickness

(1) The minimum thickness of cover over principal steel reinforcement in reinforced concrete beams is shown in Table 2.9.1. for fire-resistance ratings from 30 min to 4 h where the width of the beam or joist is at least 100 mm.

Table 2.9.1.
Minimum Cover to Principal Steel Reinforcement in Reinforced Concrete Beams, mm

Type of Concrete	Fire-Resistance Rating						
	30 min	45 min	1 h	1.5 h	2 h	3 h	4 h
Type S, N or L	20	20	20	25	25	39	50
Column 1	2	3	4	5	6	7	8

2.9.2. Maximum Rating

(1) No rating over 2 h may be assigned on the basis of Table 2.9.1. to a beam or joist where the average width of the part that projects below the slab is less than 140 mm, and no rating over 3 h may be assigned where the average width of the part that projects below the slab is less than 165 mm.

2.9.3. Beam Integrated in Floor or Roof Slab

(1) For the purposes of these ratings, a beam may be either independent of or integral with a floor or roof slab assembly.

2.9.4. Minimum Thickness

(1) Where the upper extension or top flange of a joist or T-beam in a floor assembly contributes wholly or partly to the thickness of the slab above, the total thickness at any point shall be not less than the minimum thickness described in Table 2.2.1.A. for the fire-resistance rating required.

2.9.5. Effect of Plaster

(1) The addition of plaster finish to a reinforced concrete beam may be taken into account in determining the cover over principal reinforcing steel by applying the multiplying factors described in Subsection 1.7.

2.10. Prestressed Concrete Beams

2.10.1. Minimum Cross-Sectional Area and Thickness of Cover

(1) The minimum cross-sectional area and thickness of concrete cover over steel tendons in prestressed concrete beams for fire-resistance ratings from 30 min to 4 h are shown in Table 2.10.1.

Table 2.10.1.
Minimum Thickness of Concrete Cover Over Steel Tendons in Prestressed Concrete Beams,⁽¹⁾ mm

Type of Concrete	Area of Beam, cm ²	Fire-Resistance Rating						
		30 min	45 min	1 h	1.5 h	2 h	3 h	4 h
Type S or N	260 to 970	25	39	50	64	—	—	—
	Over 970 to 1 940	25	26	39	45	64	—	—
	Over 1 940	25	26	39	39	50	77	102
Type L	Over 970	25	25	25	39	50	77	102
Column 1	2	3	4	5	6	7	8	9

Notes to Table 2.10.1.:

(1) Where the thickness of concrete cover over the tendons exceeds 64 mm, a wire mesh reinforcement with 1.57 mm diam wire and 100 mm by 100 mm openings shall be incorporated in the beams to retain the concrete in position around the tendons. The mesh reinforcement shall be located midway in the cover.

2.10.2. Minimum Cover Thickness

(1) The cover for an individual tendon shall be the minimum thickness of concrete between the surface of the tendon and the fire-exposed surface of the beam, except that for ungrouted ducts the assumed cover thickness shall be the minimum thickness of concrete between the surface of the duct and the surface of the beam. For beams in which several tendons are used, the cover is assumed to be the average of the minimum cover of the individual tendons. The cover for any individual tendon shall be not less than half the value given in Table 2.10.1. nor less than 25 mm.

2.10.3. Applicability of Ratings

(1) The ratings in Table 2.10.1. apply to a beam that is either independent of or integral with a floor or roof slab assembly. Minimum thickness of slab and minimum cover to steel tendons in prestressed concrete slabs are contained in Subsection 2.2.

2.10.4. Effect of Plaster

(1) The addition of plaster finish to a prestressed concrete beam may be taken into account in determining the cover over steel tendons by applying the multiplying factors described in Subsection 1.7.

2.10.5. Minimum Cover

- (1) Except as provided in Sentence (2), in unbonded post-tensioned prestressed concrete beams, the concrete cover to the tendon at the anchor shall be not less than 15 mm greater than the minimum required away from the anchor. The concrete cover to the anchorage bearing plate and to the end of the tendon, if it projects beyond the bearing plate, shall be not less than 25 mm.
- (2) The requirements in Sentence (1) do not apply to those portions of beams not likely to be exposed to fire (such as the ends and the tops of flanges of beams immediately below slabs).

2.11. Glued-Laminated Timber Beams and Columns

2.11.1. Applicability of Information

- (1) The information in Subsection 2.11. applies to glued-laminated timber beams and columns required to have fire-resistance ratings greater than those afforded under the provisions of Article 3.1.4.6. of Division B of the Building Code.

2.11.2. Method of Calculation

- (1) The fire-resistance rating of glued-laminated timber beams and columns in minutes shall be equal to
- (a) $0.1 f_B [4 - 2(B/D)]$ for beams which may be exposed to fire on 4 sides,
 - (b) $0.1 f_B [4 - (B/D)]$ for beams which may be exposed to fire on 3 sides,
 - (c) $0.1 f_B [3 - (B/D)]$ for columns which may be exposed to fire on 4 sides, and
 - (d) $0.1 f_B [3 - (B/2D)]$ for columns which may be exposed to fire on 3 sides,

where

f = the load factor shown in Figure 2.11.2.A.,

B = the full dimension of the smaller side of a beam or column in millimetres before exposure to fire (see Figure 2.11.2.B.),

D = the full dimension of the larger side of a beam or column in millimetres before exposure to fire (see Figure 2.11.2.B.),

k = the effective length factor obtained from CSA O86, "Engineering Design in Wood",

L = the unsupported length of a column in millimetres.

- (2) The factored resistance of a beam or column shall be determined by using the specified strengths in CSA O86, "Engineering Design in Wood".

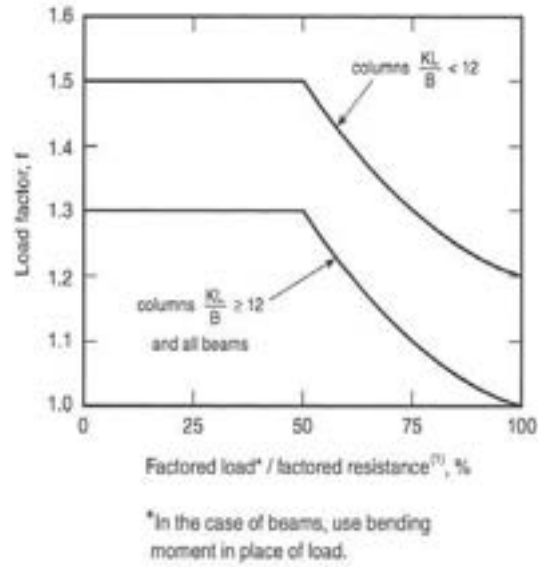


Figure 2.11.2.A.
Factors to Compensate for Partially Loaded Columns and Beams

Note to Figure 2.11.2.A.:
(1) See Sentence 2.11.2.(2).

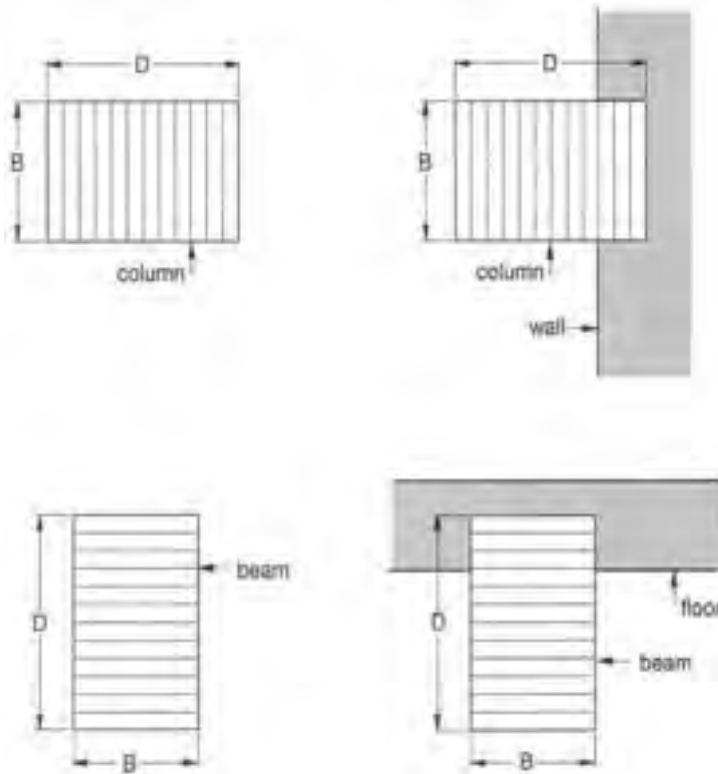


Figure 2.11.2.B.
Full Dimensions of Glued-Laminated Beams and Columns

Section 3 Flame-Spread Ratings and Smoke Developed Classifications

3.1. Interior Finish Materials

3.1.1. Scope of Information

(1) Tables 3.1.1.A. and 3.1.1.B. show flame-spread ratings and smoke developed classifications for combinations of some common interior finish materials. The values are based on all the evidence available at present. Many materials have not been included because of lack of test evidence or because of inability to classify or describe the material in generic terms for the purpose of assigning ratings.

Table 3.1.1.A.
Assigned Flame-Spread Ratings and Smoke Developed Classifications
for Combinations of Wall and Ceiling Finish Materials and Surface Coatings⁽¹⁾

Materials	Applicable Material Standard	Minimum Thickness, mm	Surface Coating	
			Unfinished	Paint or Varnish not more than 1.3 mm Thick, Cellulosic Wallpaper not more than One Layer ⁽²⁾⁽³⁾
Brick, concrete, tile	None	None	0/0	25/50
Steel, copper, aluminum	None	0.33		
Gypsum plaster	CSA A82.22-M	None		
Gypsum board	CAN/CSA-A82.27-M ASTM C1396 / C1396M	9.5	25/50	25/50
Lumber	None	16	150/300	150/300
Douglas Fir plywood ⁽⁴⁾	CSA O121	11	150/100	150/300
Poplar plywood ⁽⁴⁾	CSA O153			
Plywood with Spruce face veneer ⁽⁴⁾	CSA O151			
Douglas Fir plywood ⁽⁴⁾	CSA O121	6	150/100	150/100
Fiberboard low density	CAN/ULC-S706	11	X/100	150/100
Hardboard				
Type 1	CAN/CGSB-11.3-M	9	150/X	(5)
Standard		6	150/300	150/300
Particleboard	ANSI A208.1	12.7	150/300	(5)
Waferboard, OSB	CSA O325	—	(5)	(5)
	CSA O437.0	—	(5)	(5)
Column 1	2	3	4	5

Notes to Table 3.1.1.A.:

- (1) See Sentence 1.1.1.(5) for standards used to assign flame-spread ratings and smoke developed classifications.
- (2) Flame-spread ratings and smoke developed classifications for paints and varnish are not applicable to shellac and lacquer.
- (3) Flame-spread ratings and smoke developed classifications for paints apply only to alkyd and latex paints.
- (4) The flame-spread ratings and smoke developed classifications shown are for those plywoods without a cellulose resin overlay.
- (5) Insufficient test information available.

Table 3.1.1.B.
Flame-Spread Ratings and Smoke Developed Classifications
for Combinations of Common Floor Finish Materials and Surface Coatings⁽¹⁾

Materials	Applicable Standard	FSR/SDC ⁽²⁾
Hardwood or softwood flooring either unfinished or finished with a spar or urethane varnish coating	None	300/300
Wool carpet (woven), pile weight not less than 1120 g/m ² , applied with or without felt underlay ⁽³⁾	CAN/CGSB-4.129	300/300
Nylon carpet, pile weight not less than 610 g/m ² and not more than 800 g/m ² , applied with or without felt underlay ⁽³⁾	CAN/CGSB-4.129	300/500
Nylon carpet, pile weight not less than 610 g/m ² and not more than 1355 g/m ² , glued down to concrete	CAN/CGSB-4.129	300/500
Wool/nylon blend carpet (woven) with not more than 20% nylon and pile weight not less than 1120 g/m ²	CAN/CGSB-4.129	300/500
Nylon/wool blend carpet (woven) with not more than 50% wool, pile weight not less than 610 g/m ² and not more than 800 g/m ²	CAN/CGSB-4.129	300/500
Polypropylene carpet, pile weight not less than 500 g/m ² and not more than 1200 g/m ² , glued down to concrete	CAN/CGSB-4.129	300/500
Column 1	2	3

Notes to Table 3.1.1.B.:

- (1) Tested on the floor of the tunnel in conformance with provisions of CAN/ULC-S102.2, "Test for Surface Burning Characteristics of Flooring, Floor Coverings, and Miscellaneous Materials and Assemblies".
- (2) Flame-Spread Rating/Smoke Developed Classification
- (3) Type 1 or 2 underlay as described in CGSB 4-GP-36M, "Carpet Underlay, Fiber Type".

3.1.2. Ratings

(1) The ratings shown in Tables 3.1.1.A. and 3.1.1.B. are arranged in groups corresponding to the provisions of this Code. The ratings apply to materials falling within the general categories indicated.

3.1.3. Table Entries

(1) In Tables 3.1.1.A. and 3.1.1.B., the first number of each entry relates to flame spread and the second number to smoke developed limit. For example:

25/50 represents a flame-spread rating of 0 to 25 and a smoke developed classification of 0 to 50.

150/300 represents a flame-spread rating of 75 to 150 and a smoke developed classification of 100 to 300.

X/X applied to walls and ceilings means a flame-spread rating over 150 and a smoke developed classification over 300.

3.1.4. Effect of Surface Coatings

(1) Thin surface coatings can modify flame-spread characteristics either upward or downward. Table 3.1.1.A. includes a number of thin coatings that increase the flame-spread rating of the base material, so that these may be considered where more precise control over flame spread hazard is desired.

3.1.5. Proprietary Materials

(1) Information on flame-spread rating of proprietary materials and fire-retardant treatments that cannot be described in sufficient detail to ensure reproducibility is available through the listing and labelling services of Underwriters' Laboratories of Canada, Intertek Testing Services NA Ltd. or other recognized testing laboratory.

(2) A summary of flame-spread test results published prior to 1965 has been prepared by NRC (see Item (1) in Subsection 6.1.).

3.1.6. Limitations and Conditions

(1) The propagation of flame along a surface in the standard test involves some finite depth of the material or materials behind the surface, and this involvement extends to the depth to which temperature variations are to be found during the course of the test; for many commonly used lining materials, such as wood, the depth involved is about 25 mm.

(2) For all the combustible materials described in Table 3.1.1.A., a minimum dimension is shown, and this represents the thickness of the test samples on which the rating has been based; when used in greater thicknesses than that shown, these materials may have a slightly lower flame-spread rating, and thinner specimens may have higher flame-spread ratings.

(3) No rating has been included for foamed plastic materials because it is not possible at this time to identify these products with sufficient accuracy on a generic basis. Materials of this type which melt when exposed to the test flame generally show an increase in flame-spread rating as the thickness of the test specimen increases.

3.1.7. Referenced Standards

In Tables 3.1.1.A. and 3.1.1.B., the standards applicable to the materials described are noted because the ratings depend on conformance with these specifications.

Section 4 Noncombustibility

4.1. Test Method

4.1.1. Determination of Noncombustibility

(1) Noncombustibility is required of certain components of buildings by the provisions of this Code, which specifies noncombustibility by reference to CAN/ULC-S114, "Test for Determination of Non-Combustibility in Building Materials".

(2) The test to which reference is made in Sentence (1) is severe, and it may be assumed that any building material containing even a small proportion of combustibles will itself be classified as combustible. The specimen, 38 mm by 51 mm, is exposed to a temperature of 750°C in a small furnace. The essential criteria for noncombustibility are that the specimen does not flame or contribute to temperature rise.

4.2. Materials Classified as Combustible

4.2.1. Combustible Materials

(1) Most materials from animal or vegetable sources will be classed as combustible by CAN/ULC-S114, "Test for Determination of Non-Combustibility in Building Materials", and wood, wood fibreboard, paper, felt made from animal or vegetable fibres, cork, plastics, asphalt and pitch would therefore be classed as combustible.

4.2.2. Composite Materials

(1) Materials that consist of combustible and noncombustible elements in combination will in many cases also be classed as combustible, unless the proportion of combustibles is very small. Some mineral wool insulations with combustible binder, cinder concrete, cement and wood chips and wood-fibred gypsum plaster would also be classed as combustible.

4.2.3. Effect of Chemical Additives

(1) The addition of a fire-retardant chemical is not sufficient to change a combustible product to a noncombustible product.

4.3. Materials Classified as Noncombustible

4.3.1. Typical Examples

(1) Noncombustible materials include brick, ceramic tile, concrete made from Portland cement with noncombustible aggregate, plaster made from gypsum with noncombustible aggregate, metals commonly used in buildings, glass, granite, sandstone, slate, limestone and marble.

Section 5 Protection of Openings in Fire-Rated Assemblies

5.1. Scope

5.1.1. Installation Information

(1) The information in this Section specifies requirements for the installation of fire doors and fire dampers in gypsum-board-protected stud wall assemblies.

5.2. Installation of Fire Doors and Fire Dampers

5.2.1. References

(1) Fire doors and fire dampers in gypsum-board-protected steel stud non-loadbearing walls required to have a fire-resistance rating shall be installed in conformance with Section 9.24. of Division B of the Building Code and the applicable requirements of NFPA 80, "Fire Doors and Other Opening Protectives".

- (2) Fire doors and fire dampers in gypsum-board-protected wood stud walls required to have a fire-resistance rating shall be installed in conformance with Section 9.23. of Division B of the Building Code and the applicable requirements of NFPA 80, "Fire Doors and Other Opening Protectives".

Section 6 Background Information

6.1. Fire Test Reports

Summaries of available fire test information have been published by NRC as follows:

- (1) M. Galbreath, Flame Spread Performance of Common Building Materials. Technical Paper No. 170, Division of Building Research, National Research Council Canada, Ottawa, April 1964. NRCC 7820.
- (2) M. Galbreath and W.W. Stanzak, Fire Endurance of Protected Steel Columns and Beams. Technical Paper No. 194, Division of Building Research, National Research Council Canada, Ottawa, April 1965. NRCC 8379.
- (3) T.Z. Harmathy and W.W. Stanzak, Elevated-Temperature Tensile and Creep Properties of Some Structural and Prestressing Steels. American Society for Testing and Materials, Special Technical Publication 464, 1970, p. 186 (DBR Research Paper No. 424) NRCC 11163.
- (4) T.Z. Harmathy, Thermal Performance of Concrete Masonry Walls in Fire. American Society for Testing and Materials, Special Technical Publication 464, 1970, p. 209 (DBR Research Paper No. 423) NRCC 11161.
- (5) L.W. Allen, Fire Endurance of Selected Non-Loadbearing Concrete Masonry Walls. DBR Fire Study No. 25, Division of Building Research, National Research Council Canada, Ottawa, March 1970. NRCC 11275.
- (6) A. Rose, Comparison of Flame Spread Ratings by Radiant Panel, Tunnel Furnace, and Pittsburgh-Corning Apparatus. DBR Fire Study No. 22, Division of Building Research, National Research Council Canada, Ottawa, June 1969. NRCC 10788.
- (7) T.T. Lie and D.E. Allen, Calculation of the Fire Resistance of Reinforced Concrete Columns. DBR Technical Paper No. 378, Division of Building Research, National Research Council Canada, Ottawa, August 1972. NRCC 12797.
- (8) W.W. Stanzak, Column Covers: A Practical Application of Sheet Steel as a Protective Membrane. DBR Fire Study No. 27, Division of Building Research, National Research Council Canada, Ottawa, February 1972. NRCC 12483.
- (9) W.W. Stanzak, Sheet Steel as a Protective Membrane for Steel Beams and Columns. DBR Fire Study No. 23, Division of Building Research, National Research Council Canada, Ottawa, November 1969. NRCC 10865.
- (10) W.W. Stanzak and T.T. Lie, Fire Tests on Protected Steel Columns with Different Cross-Sections. DBR Fire Study No. 30, Division of Building Research, National Research Council Canada, Ottawa, February 1973. NRCC 13072.
- (11) G. Williams-Leir and L.W. Allen, Prediction of Fire Endurance of Concrete Masonry Walls. DBR Technical Paper No. 399, Division of Building Research, National Research Council Canada, Ottawa, November 1973. NRCC 13560.
- (12) G. Williams-Leir, Prediction of Fire Endurance of Concrete Slabs. DBR Technical Paper No. 398, Division of Building Research, National Research Council Canada, Ottawa, November 1973. NRCC 13559.
- (13) A. Rose, Flammability of Fibreboard Interior Finish Materials. Building Research Note No. 68, Division of Building Research, National Research Council Canada, Ottawa, October 1969.

- (14) L.W. Allen, Effect of Sand Replacement on the Fire Endurance of Lightweight Aggregate Masonry Units. DBR Fire Study No. 26, Division of Building Research, National Research Council Canada, Ottawa, September 1971. NRCC 12112.
- (15) L.W. Allen, W.W. Stanzak and M. Galbreath, Fire Endurance Tests on Unit Masonry Walls with Gypsum Board. DBR Fire Study No. 32, Division of Building Research, National Research Council Canada, Ottawa, February 1974, NRCC 13901.
- (16) W.W. Stanzak and T.T. Lie, Fire Resistance of Unprotected Steel Columns. Journal of Structural Division, Proc., Am. Soc. Civ. Eng., Vol. 99, No. ST5 Proc. Paper 9719, May 1973 (DBR Research Paper No. 577) NRCC 13589.
- (17) T.T. Lie and T.Z. Harmathy, Fire Endurance of Concrete-Protected Steel Columns. A.C.I. Journal, January 1974, Title No. 71-4 (DBR Technical Paper No. 597) NRCC 13876.
- (18) T.T. Lie, A Method for Assessing the Fire Resistance of Laminated Timber Beams and Columns. Can. J. Civ. Eng., Vol. 4, No. 2, June 1977 (DBR Technical Paper No. 718) NRCC 15946.
- (19) T.T. Lie, Calculation of the Fire Resistance of Composite Concrete Floor and Roof Slabs. Fire Technology, Vol. 14, No. 1, February 1978 (DBR Technical Paper No. 772) NRCC 16658.
- (20) M.A. Sultan, Y.P. Séguin and P. Leroux. Results of Fire Resistance Tests on Full-Scale Floor Assemblies, Institute for Research in Construction, National Research Council of Canada, Ottawa, May 1998, IRC-IR-764.
- (21) M.A. Sultan, J.C. Latour, P. Leroux, R.C. Monette, Y.P. Séguin and J.P. Henrie, Results of Fire Resistance Tests on Full-Scale Floor Assemblies – Phase II, Institute for Research in Construction, National Research Council of Canada, Ottawa, March 2005, RR-184.
- (22) M.A. Sultan and G.D. Lougheed, Results of Fire Resistance Tests on Full-Scale Gypsum Board Wall Assemblies, Institute for Research in Construction, National Research Council of Canada, Ottawa, August 2002, IRC-IR-833.
- (23) V.K.R. Kodur, M.A. Sultan, J.C. Latour, P. Leroux, R.C. Monette, Experimental Studies on the Fire Resistance of Load-Bearing Steel Stud Walls, Research Report, National Research Council of Canada, Ottawa, August 2013, RR-343.

6.2. Obsolete Materials and Assemblies

Building materials, components and structural members and assemblies in buildings constructed before 1995 may have been assigned ratings based on earlier editions of The Supplement to the National Building Code of Canada or older reports of fire tests. To assist users in determining the ratings of these obsolete assemblies and structural members, the following list of reference documents has been prepared. Although some of these publications are out of print, reference copies are available through NRC.

- (1) M. Galbreath, Fire Endurance of Unit Masonry Walls. Technical Paper No. 207, Division of Building Research, National Research Council Canada, Ottawa, October 1965. NRCC 8740.
- (2) M. Galbreath, Fire Endurance of Light Framed and Miscellaneous Assemblies. Technical Paper No. 222, Division of Building Research, National Research Council Canada, Ottawa, June 1966. NRCC 9085.
- (3) M. Galbreath, Fire Endurance of Concrete Assemblies. Technical Paper No. 235, Division of Building Research, National Research Council Canada, Ottawa, November 1966. NRCC 9279.
- (4) Guideline on Fire Ratings of Archaic Materials and Assemblies. Rehabilitation Guideline #8, U.S. Department of Housing and Urban Development, Germantown, Maryland 20767, October 1980.
- (5) T.Z. Harmathy, Fire Test of a Plank Wall Construction. Fire Study No. 2, Division of Building Research, National Research Council Canada, Ottawa, July 1960. NRCC 5760.

- (6) T.Z. Harmathy, Fire Test of a Wood Partition. Fire Study No. 3, Division of Building Research, National Research Council Canada, Ottawa, October 1960. NRCC 5769.

6.3. Assessment of Archaic Assemblies

Information in this document applies to new construction. Please refer to early editions of the Supplement to the National Building Code of Canada for the assessment or evaluation of assemblies that do not conform to the information in this edition of the Building Code. As with other documents, this Code is revised according to the information presented to the standing committee responsible for its content, and with each update new material may be added and material that is not relevant may be deleted.

6.4. Development of the Component Additive Method

The component additive method was developed based upon the following observations and conclusions drawn from published as well as unpublished test information.

Study of the test data showed that structural failure preceded failure by other criteria (transmission of heat or hot gases) in most of the tests of loadbearing wood-framed assemblies. The major contributor to fire resistance was the membrane on the fire-exposed side.

Fire tests of wood joist floors without protective ceilings resulted in structural failure between 8 and 10 min. Calculation of the time for wood joists to approach breaking stress, based upon the charring rate of natural woods, suggested a time of 10 min for structural failure. This time was subtracted from the fire-resistance test results of wood joist floors and the remainder considered to be the contribution of the membrane.

The figures obtained for the contribution of membranes were then applied to the test results for open web steel joist floors and wood and steel stud walls and values of 20 min for the contribution of wood stud framing and 10 min for steel framing were derived.

The fire-resistance rating has been limited to 1.5 h as this method of developing ratings for framed assemblies was new and untried. Although this is the subject of current review, no decision has been made to extend the ratings beyond 1.5 h.

- (1) M. Galbreath, G. C. Gosselin, and R. B. Chauhan, Historical Guide to Chapter 2 of the Supplement to the National Building Code of Canada, Committee Paper FPR 1-3, Prepared for the Standing Committee on Fire Performance Ratings, May 1987.

Example showing fire-resistance rating of a typical membrane assembly, calculated using the component additive method.

1 Hour Gypsum Board/Wood Stud Interior Partition

A 1 h fire-resistance rating is required for an interior wood framed partition, using 12.7 mm Type X gypsum board.

- (a) Since gypsum board is used (Sentence 2.3.4.(2) and Table 2.3.4.A.) time assigned to 12.7 mm Type X gypsum board membrane on the fire-exposed side of the partition = 25 min
 - (b) Time assigned to wood framing members at 406 mm o.c. (Sentence 2.3.4.(3) and Table 2.3.4.E.) = 20 min
 - (c) Time assigned to insulation, if the spaces between the studs are filled with preformed insulation of rock or slag fibres conforming to CAN/ULC-S702, "Mineral Fibre Thermal Insulation for Buildings", (Sentence 2.3.4.(4) and Table 2.3.4.G.) = 15 min
 - (d) Time assigned to the membrane on the non-fire-exposed side (Sentence 2.3.5.(1)) = 0 min
- Fire-resistance rating = 25 + 20 + 15 = 60 min

MMAH Supplementary Standard SB-3

Fire and Sound Resistance of Building Assemblies

January 15, 2019 update

COMMENCEMENT

MMAH Supplementary Standard SB-3 comes into force on the 1st day of January, 2014.

r5 SB-3 as amended by Ontario Regulation 191/14 comes into force on the 1st day of January, 2015.

r11.1 SB-3 as amended by Ontario Regulation 88/19 comes into force on the 1st day of January, 2020.

© Copyright

© Copyright Queen's Printer for Ontario 2019

All rights reserved.

Questions regarding copyright, including reproduction and distribution, may be directed to the Director,
Building and Development Branch of the Ministry of Municipal Affairs and Housing.

r11.1 SB-3 Fire and Sound Resistance of Building Assemblies

(This Standard is based in large measure on the Fire and Sound Resistance Tables of the model National Building Code of Canada 2015)

The following Tables may be used to select building assemblies for compliance with Articles 5.8.1.3., 9.10.3.1., 9.10.5.1., 9.11.1.3., 9.11.1.4. and 9.29.5.9. of Division B of the 2012 Building Code.

Tables 1 and 2 have been developed from information gathered from tests. While a large number of the assemblies listed were tested, the fire-resistance and acoustical ratings for others were assigned on the basis of extrapolation of information from tests of similar assemblies. Where there was enough confidence relative to the fire performance of an assembly, the fire-resistance ratings were assigned relative to the commonly used minimum ratings of 30 min, 45 min and 1 h, including a designation of "< 30 min" for assemblies that are known not to meet the minimum 30-minute rating. Where there was not enough comparative information on an assembly to assign to it a rating with confidence, its value in the Tables has been left blank (hyphen), indicating that its rating remains to be assessed through another means

These Tables are provided only for the convenience of Code users and do not limit the number of assemblies permitted to those in the Tables. Assemblies not listed or not given a rating in these Tables are equally acceptable provided their fire and sound resistance can be demonstrated to meet the above-noted requirements either on the basis of tests referred to in Article 9.10.3.1. and Subsection 9.11.1. or by using the data in MMAH Supplementary Standard SB-2, "Fire-Performance Ratings". It should be noted, however, that Tables 1 and 2 of this Supplementary Standard are not based on the same assumptions as those used in MMAH Supplementary Standard SB-2. Assemblies in Tables 1 and 2 are described through their generic descriptions and variants and include details given in the notes to the Tables. Assumptions for MMAH Supplementary Standard SB-2 include different construction details that must be followed rigorously for the calculated ratings to be expected. These are two different methods of choosing assemblies that meet required fire ratings.

Table 2 presents fire-resistance and acoustical ratings for floor, ceiling and roof assemblies. The fire-resistance ratings are appropriate for all assemblies conforming to the construction specifications given in Table 2, including applicable Table notes. Acoustical ratings for assemblies decrease with decreasing depth and decreasing separation of the structural members; the values listed for sound transmission class and impact insulation class are suitable for the minimum depth of structural members identified in the description, including applicable Table notes, and for structural member spacing of 305 mm o.c., unless other values are explicitly listed for the assembly. Adjustments to the acoustical ratings to allow for the benefit of deeper or more widely spaced structural members are given in Table Notes (9) and (10).

Section 1 Fire and Sound Resistance of Walls

Table 1
Fire and Sound Resistance of Walls⁽¹⁾

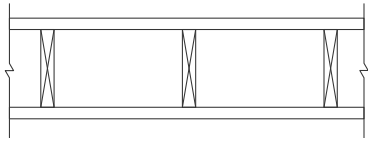
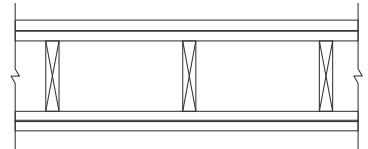
Type of Wall	Wall Number	Description	Fire-Resistance Rating ⁽²⁾⁽³⁾		Typical Sound Transmission Class ⁽²⁾⁽⁴⁾⁽⁵⁾ (STC)	
			Loadbearing	Non-Loadbearing		
<ul style="list-style-type: none"> • Wood Studs • Single Row • Loadbearing or Non-Loadbearing 	W1	<ul style="list-style-type: none"> • 38 mm x 89 mm wood studs spaced 406 mm or 610 mm o.c. • with or without absorptive material • 1 layer of gypsum board on each side 				
	W1a	W1 with <ul style="list-style-type: none"> • 89 mm thick absorptive material⁽⁶⁾ • 15.9 mm Type X gypsum board⁽⁷⁾ 	1 h	1 h	36	
	W1b	W1 with <ul style="list-style-type: none"> • 89 mm thick absorptive material⁽⁶⁾ • 12.7 mm Type X gypsum board⁽⁷⁾ 	45 min [1 h] ⁽⁸⁾	45 min [1 h] ⁽⁸⁾	34	
	W1c	W1 with <ul style="list-style-type: none"> • 89 mm thick absorptive material⁽⁶⁾ • 12.7 mm regular gypsum board⁽⁷⁾⁽⁹⁾ 	30 min	30 min [45 min] ⁽⁸⁾	32	
	W1d	W1 with <ul style="list-style-type: none"> • no absorptive material • 15.9 mm Type X gypsum board⁽⁷⁾ 	1 h	1 h	32	
	W1e	W1 with <ul style="list-style-type: none"> • no absorptive material • 12.7 mm Type X gypsum board⁽⁷⁾ 	45 min	45 min	32	
	W2	<ul style="list-style-type: none"> • 38 mm x 89 mm wood studs spaced 406 mm or 610 mm o.c. • with or without absorptive material • 2 layers of gypsum board on each side 				
	W2a	W2 with <ul style="list-style-type: none"> • 89 mm thick absorptive material⁽⁶⁾ • 15.9 mm Type X gypsum board⁽⁷⁾ 	1.5 h	2 h	38	
	W2b	W2 with <ul style="list-style-type: none"> • 89 mm thick absorptive material⁽⁶⁾ • 12.7 mm Type X gypsum board⁽⁷⁾ 	1 h	1.5 h	38	
	W2c	W2 with <ul style="list-style-type: none"> • 89 mm thick absorptive material⁽⁶⁾ • 12.7 mm regular gypsum board⁽⁷⁾ 	45 min	1 h	36	
	W2d	W2 with <ul style="list-style-type: none"> • no absorptive material • 15.9 mm Type X gypsum board⁽⁷⁾ 	1.5 h	2 h	36	
	Column 1	2	3	4	5	6

Table 1 (Cont'd)
Fire and Sound Resistance of Walls⁽¹⁾

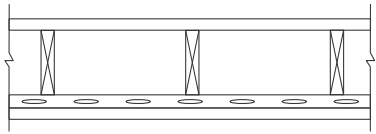
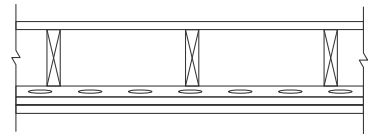
Type of Wall	Wall Number	Description	Fire-Resistance Rating ⁽²⁾⁽³⁾		Typical Sound Transmission Class ⁽²⁾⁽⁴⁾⁽⁵⁾ (STC)	
			Loadbearing	Non-Loadbearing		
<ul style="list-style-type: none"> • Wood Studs • Single Row • Loadbearing or Non-Loadbearing 	W2e	W2 with <ul style="list-style-type: none"> • no absorptive material • 12.7 mm Type X gypsum board⁽⁷⁾ 	1 h	1.5 h	35	
	W2f	W2 with <ul style="list-style-type: none"> • no absorptive material • 12.7 mm regular gypsum board⁽⁷⁾ 	45 min	1 h	34	
	W3	<ul style="list-style-type: none"> • 38 mm x 89 mm wood studs spaced 406 mm or 610 mm o.c. • 89 mm thick absorptive material⁽⁶⁾ • resilient metal channels on one side spaced 406 mm or 610 mm o.c. • 1 layer of gypsum board on each side 				
	W3a	W3 with <ul style="list-style-type: none"> • studs spaced 406 mm o.c. • 15.9 mm Type X gypsum board⁽⁷⁾ 	45 min	1 h	45	
	W3b	W3 with <ul style="list-style-type: none"> • studs spaced 610 mm o.c. • 15.9 mm Type X gypsum board⁽⁷⁾ 	45 min	1 h	48	
	W3c	W3 with <ul style="list-style-type: none"> • studs spaced 406 mm or 610 mm o.c. • 12.7 mm Type X gypsum board⁽⁷⁾ 	45 min	45 min	43	
	W4	<ul style="list-style-type: none"> • 38 mm x 89 mm wood studs spaced 406 mm or 610 mm o.c. • 89 mm thick absorptive material⁽⁶⁾ • resilient metal channels on one side spaced 406 mm or 610 mm o.c. • 2 layers of gypsum board on resilient metal channel side • 1 layer of gypsum board on other side 				
	W4a	W4 with <ul style="list-style-type: none"> • studs spaced 406 mm o.c. • 15.9 mm Type X gypsum board⁽⁷⁾ 	1 h	1 h [1.5 h] ⁽⁸⁾	51	
	W4b	W4 with <ul style="list-style-type: none"> • studs spaced 610 mm o.c. • 15.9 mm Type X gypsum board⁽⁷⁾ 	1 h	1 h [1.5 h] ⁽⁸⁾	54	
	W4c	W4 with <ul style="list-style-type: none"> • studs spaced 406 mm o.c. • 12.7 mm Type X gypsum board⁽⁷⁾ 	45 min [1 h] ⁽⁸⁾	1 h	49	
	W4d	W4 with <ul style="list-style-type: none"> • studs spaced 610 mm o.c. • 12.7 mm Type X gypsum board⁽⁷⁾ 	45 min [1 h] ⁽⁸⁾	1 h	53	
	Column 1	2	3	4	5	6

Table 1 (Cont'd)
Fire and Sound Resistance of Walls⁽¹⁾

Type of Wall	Wall Number	Description	Fire-Resistance Rating ⁽²⁾⁽³⁾		Typical Sound Transmission Class ⁽²⁾⁽⁴⁾⁽⁵⁾ (STC)
			Loadbearing	Non-Loadbearing	
<ul style="list-style-type: none"> • Wood Studs • Single Row • Loadbearing or Non-Loadbearing 	W5	<ul style="list-style-type: none"> • 38 mm x 89 mm wood studs spaced 406 mm or 610 mm o.c. • 89 mm thick absorptive material⁽⁶⁾ • resilient metal channels on one side spaced 406 mm or 610 mm o.c. • 1 layer of gypsum board on resilient metal channel side • 2 layers of gypsum board on other side 			
	W5a	<ul style="list-style-type: none"> • studs spaced 406 mm o.c. • 15.9 mm Type X gypsum board⁽⁷⁾ 	45 min	1 h	51
	W5b	<ul style="list-style-type: none"> • studs spaced 610 mm o.c. • 15.9 mm Type X gypsum board⁽⁷⁾ 	45 min	1 h	54
	W5c	<ul style="list-style-type: none"> • studs spaced 406 mm o.c. • 12.7 mm Type X gypsum board⁽⁷⁾ 	45 min	1 h	49
	W5d	<ul style="list-style-type: none"> • studs spaced 610 mm o.c. • 12.7 mm Type X gypsum board⁽⁷⁾ 	45 min	1 h	53
	W6	<ul style="list-style-type: none"> • 38 mm x 89 mm wood studs spaced 406 mm or 610 mm o.c. • with or without absorptive material • resilient metal channels on one side • 2 layers of gypsum board on each side 			
	W6a	<ul style="list-style-type: none"> • studs spaced 406 mm or 610 mm o.c. • 89 mm thick absorptive material⁽⁶⁾ • resilient metal channels spaced 406 mm o.c. • 15.9 mm Type X gypsum board⁽⁷⁾ 	1.5 h	2 h	55
	W6b	<ul style="list-style-type: none"> • studs spaced 406 mm or 610 mm o.c. • 89 mm thick absorptive material⁽⁶⁾ • resilient metal channels spaced 610 mm o.c. • 15.9 mm Type X gypsum board⁽⁷⁾ 	1.5 h	2 h	58
	W6c	<ul style="list-style-type: none"> • studs spaced 406 mm o.c. • 89 mm thick absorptive material⁽⁶⁾ • resilient metal channels spaced 406 mm o.c. • 12.7 mm Type X gypsum board⁽⁷⁾ 	1 h	1.5 h	53
	Column 1	2	3	4	5

Table 1 (Cont'd)
Fire and Sound Resistance of Walls⁽¹⁾

Type of Wall	Wall Number	Description	Fire-Resistance Rating ⁽²⁾⁽³⁾		Typical Sound Transmission Class ⁽²⁾⁽⁴⁾⁽⁵⁾ (STC)
			Loadbearing	Non-Loadbearing	
<ul style="list-style-type: none"> • Wood Studs • Single Row • Loadbearing or Non-Loadbearing 	W6d	W6 with <ul style="list-style-type: none"> • studs spaced 406 mm o.c. • 89 mm thick absorptive material⁽⁶⁾ • resilient metal channels spaced 610 mm o.c. • 12.7 mm Type X gypsum board⁽⁷⁾ 	1 h	1.5 h	55
	W6e	W6 with <ul style="list-style-type: none"> • studs spaced 610 mm o.c. • 89 mm thick absorptive material⁽⁶⁾ • resilient metal channels spaced 406 mm o.c. • 12.7 mm Type X gypsum board⁽⁷⁾ 	1 h	1.5 h	55
	W6f	W6 with <ul style="list-style-type: none"> • studs spaced 610 mm o.c. • 89 mm thick absorptive material⁽⁶⁾ • resilient metal channels spaced 610 mm o.c. • 12.7 mm Type X gypsum board⁽⁷⁾ 	1 h	1.5 h	58
	W6g	W6 with <ul style="list-style-type: none"> • studs spaced 406 mm or 610 mm o.c. • 89 mm thick absorptive material⁽⁶⁾ • resilient metal channels spaced 406 mm o.c. • 12.7 mm regular gypsum board⁽⁷⁾ 	45 min	1 h	50
	W6h	W6 with <ul style="list-style-type: none"> • studs spaced 406 mm or 610 mm o.c. • 89 mm thick absorptive material⁽⁶⁾ • resilient metal channels spaced 610 mm o.c. • 12.7 mm regular gypsum board⁽⁷⁾ 	45 min	1 h	52
	W6i	W6 with <ul style="list-style-type: none"> • studs spaced 406 mm or 610 mm o.c. • no absorptive material • resilient metal channels spaced 406 mm or 610 mm o.c. • 15.9 mm Type X gypsum board⁽⁷⁾ 	1.5 h	2 h	47
	W6j	W6 with <ul style="list-style-type: none"> • studs spaced 406 mm or 610 mm o.c. • no absorptive material • resilient metal channels spaced 406 mm or 610 mm o.c. • 12.7 mm Type X gypsum board⁽⁷⁾ 	1 h	1.5 h	46
Column 1	2	3	4	5	6

Table 1 (Cont'd)
Fire and Sound Resistance of Walls⁽¹⁾

Type of Wall	Wall Number	Description	Fire-Resistance Rating ⁽²⁾⁽³⁾		Typical Sound Transmission Class ⁽²⁾⁽⁴⁾⁽⁵⁾ (STC)	
			Loadbearing	Non-Loadbearing		
<ul style="list-style-type: none"> • Wood Studs • Two Rows Staggered on 38 mm x 140 mm plate • Loadbearing or Non-Loadbearing 	W7	<ul style="list-style-type: none"> • two rows 38 mm x 89 mm wood studs each spaced 406 mm or 610 mm o.c. staggered on common 38 mm x 140 mm plate • 89 mm thick absorptive material on one side or 65 mm thick on each side⁽⁶⁾ • 1 layer of gypsum board on each side 				
	W7a	W7 with <ul style="list-style-type: none"> • 15.9 mm Type X gypsum board⁽⁷⁾ 	1 h	1 h	47	
	W7b	W7 with <ul style="list-style-type: none"> • 12.7 mm Type X gypsum board⁽⁷⁾ 	45 min [1 h] ⁽⁸⁾	45 min [1 h] ⁽⁸⁾	45	
	W7c	W7 with <ul style="list-style-type: none"> • 12.7 mm regular gypsum board⁽⁷⁾⁽⁹⁾ 	30 min	30 min [45 min] ⁽⁸⁾	42	
	W8	<ul style="list-style-type: none"> • two rows 38 mm x 89 mm wood studs each spaced 406 mm or 610 mm o.c. staggered on common 38 mm x 140 mm plate • 89 mm thick absorptive material on one side or 65 mm thick on each side⁽⁶⁾ • 2 layers of gypsum board on one side • 1 layer of gypsum board on other side 				
	W8a	W8 with <ul style="list-style-type: none"> • 15.9 mm Type X gypsum board⁽⁷⁾ 	1 h	1.5 h	52	
	W8b	W8 with <ul style="list-style-type: none"> • 12.7 mm Type X gypsum board⁽⁷⁾ 	45 min	1 h	50	
	W9	<ul style="list-style-type: none"> • two rows 38 mm x 89 mm wood studs each spaced 406 mm or 610 mm o.c. staggered on common 38 mm x 140 mm plate • with or without absorptive material • 2 layers of gypsum board on each side 				
	W9a	W9 with <ul style="list-style-type: none"> • 89 mm thick absorptive material on one side or 65 mm thick on each side⁽⁶⁾ • 15.9 mm Type X gypsum board⁽⁷⁾ 	1.5 h	2 h	56	
	W9b	W9 with <ul style="list-style-type: none"> • 89 mm thick absorptive material on one side or 65 mm thick on each side⁽⁶⁾ • 12.7 mm Type X gypsum board⁽⁷⁾ 	1 h	1.5 h	55	
	W9c	W9 with <ul style="list-style-type: none"> • 89 mm thick absorptive material on one side or 65 mm thick on each side⁽⁶⁾ • 12.7 mm regular gypsum board⁽⁷⁾ 	45 min	1 h	53	
	Column 1	2	3	4	5	6

Table 1 (Cont'd)
Fire and Sound Resistance of Walls⁽¹⁾

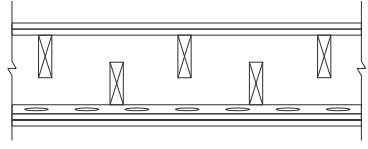
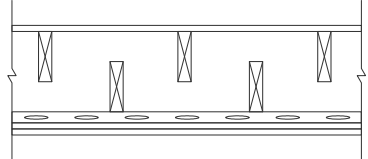
Type of Wall	Wall Number	Description	Fire-Resistance Rating ⁽²⁾⁽³⁾		Typical Sound Transmission Class ⁽²⁾⁽⁴⁾⁽⁵⁾ (STC)
			Loadbearing	Non-Loadbearing	
<ul style="list-style-type: none"> • Wood Studs • Two Rows Staggered on 38 mm x 140 mm plate • Loadbearing or Non-Loadbearing 	W9d	<ul style="list-style-type: none"> • W9 with • no absorptive material • 15.9 mm Type X gypsum board⁽⁷⁾ 	1.5 h	2 h	48
	W10	<ul style="list-style-type: none"> • two rows 38 mm x 89 mm wood studs each spaced 406 mm or 610 mm o.c. staggered on common 38 mm x 140 mm plate • with or without absorptive material • resilient metal channels on one side spaced 406 mm or 610 mm o.c. • 2 layers of gypsum board on each side 			
	W10a	<ul style="list-style-type: none"> • W10 with • 89 mm thick absorptive material on one side or 65 mm thick on each side⁽⁶⁾ • 15.9 mm Type X gypsum board⁽⁷⁾ 	1.5 h	2 h	62
	W10b	<ul style="list-style-type: none"> • W10 with • 89 mm thick absorptive material on one side or 65 mm thick on each side⁽⁶⁾ • 12.7 mm Type X gypsum board⁽⁷⁾ 	1 h	1.5 h	60
	W10c	<ul style="list-style-type: none"> • W10 with • no absorptive material • 15.9 mm Type X gypsum board⁽⁷⁾ 	1.5 h	2 h	50
	W10d	<ul style="list-style-type: none"> • W10 with • no absorptive material • 12.7 mm Type X gypsum board⁽⁷⁾ 	1 h	1.5 h	48
	W11	<ul style="list-style-type: none"> • two rows 38 mm x 89 mm wood studs each spaced 406 mm or 610 mm o.c. staggered on common 38 mm x 140 mm plate • 89 mm thick absorptive material on one side or 65 mm thick on each side⁽⁶⁾ • resilient metal channels on one side spaced 406 mm or 610 mm o.c. • 2 layers of gypsum board on resilient channel side • 1 layer of gypsum board on other side 			
	W11a	<ul style="list-style-type: none"> • W11 with • 15.9 mm Type X gypsum board⁽⁷⁾ 	1 h	1 h	56
	W11b	<ul style="list-style-type: none"> • W11 with • 12.7 mm Type X gypsum board⁽⁷⁾ 	45 min [1 h] ⁽⁸⁾	1 h	54
	Column 1	2	3	4	5

Table 1 (Cont'd)
Fire and Sound Resistance of Walls⁽¹⁾

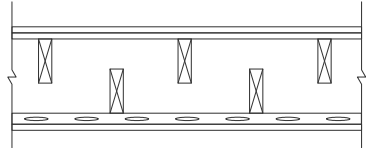
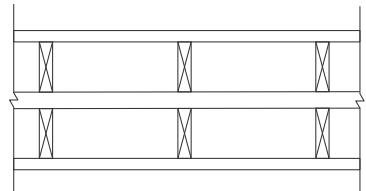
Type of Wall	Wall Number	Description	Fire-Resistance Rating ⁽²⁾⁽³⁾		Typical Sound Transmission Class ⁽²⁾⁽⁴⁾⁽⁵⁾ (STC)
			Loadbearing	Non-Loadbearing	
<ul style="list-style-type: none"> • Wood Studs • Two Rows Staggered on 38 mm x 140 mm plate • Loadbearing or Non-Loadbearing 	W12	<ul style="list-style-type: none"> • two rows 38 mm x 89 mm wood studs each spaced 406 mm or 610 mm o.c. staggered on common 38 mm x 140 mm plate • 89 mm thick absorptive material on one side or 65 mm thick on each side⁽⁶⁾ • resilient metal channels on one side spaced 406 mm or 610 mm o.c. • 1 layer of gypsum board on resilient metal channel side • 2 layers of gypsum board on other side 			
	W12a	W12 with <ul style="list-style-type: none"> • 15.9 mm Type X gypsum board⁽⁷⁾ 	45 min	1 h	56
	W12b	W12 with <ul style="list-style-type: none"> • 12.7 mm Type X gypsum board⁽⁷⁾ 	45 min	1 h	54
<ul style="list-style-type: none"> • Wood Studs • Two Rows on Separate Plates • Loadbearing or Non-Loadbearing 	W13	<ul style="list-style-type: none"> • two rows 38 mm x 89 mm wood studs each spaced 406 mm or 610 mm o.c. on separate 38 mm x 89 mm plates set 25 mm apart • with or without absorptive material • 1 layer of gypsum board on each side 			
	W13a	W13 with <ul style="list-style-type: none"> • 89 mm thick absorptive material on each side⁽⁶⁾⁽¹⁰⁾ • 15.9 mm Type X gypsum board⁽⁷⁾ 	1 h	1 h	57
	W13b	W13 with <ul style="list-style-type: none"> • 89 mm thick absorptive material on each side⁽⁶⁾⁽¹⁰⁾ • 12.7 mm Type X gypsum board⁽⁷⁾ 	45 min [1 h] ⁽⁸⁾	45 min [1 h] ⁽⁸⁾	57
	W13c	W13 with <ul style="list-style-type: none"> • 89 mm thick absorptive material on one side only⁽⁶⁾⁽¹⁰⁾ • 15.9 mm Type X gypsum board⁽⁷⁾ 	1 h	1 h	54
	W13d	W13 with <ul style="list-style-type: none"> • 89 mm thick absorptive material on one side only⁽⁶⁾⁽¹⁰⁾ • 12.7 mm Type X gypsum board⁽⁷⁾ 	45 min	45 min	53
	W13e	W13 with <ul style="list-style-type: none"> • no absorptive material • 15.9 mm Type X gypsum board⁽⁷⁾ 	1 h	1 h	45
	W13f	W13 with <ul style="list-style-type: none"> • no absorptive material • 12.7 mm Type X gypsum board⁽⁷⁾ 	45 min	45 min	45
Column 1	2	3	4	5	6

Table 1 (Cont'd)
Fire and Sound Resistance of Walls⁽¹⁾

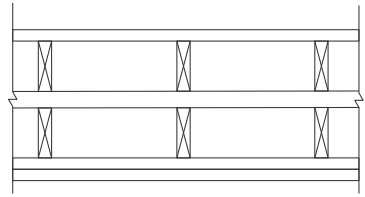
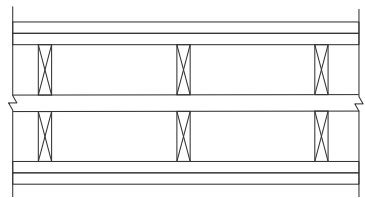
Type of Wall	Wall Number	Description	Fire-Resistance Rating ⁽²⁾⁽³⁾		Typical Sound Transmission Class ⁽²⁾⁽⁴⁾⁽⁵⁾ (STC)	
			Loadbearing	Non-Loadbearing		
<ul style="list-style-type: none"> • Wood Studs • Two Rows on Separate Plates • Loadbearing or Non-Loadbearing 	W14	<ul style="list-style-type: none"> • two rows 38 mm x 89 mm wood studs each spaced 406 mm or 610 mm o.c. on separate 38 mm x 89 mm plates set 25 mm apart • with or without absorptive material • 2 layers of gypsum board on one side • 1 layer of gypsum board on other side 				
	W14a	<ul style="list-style-type: none"> • W14 with • 89 mm thick absorptive material on each side⁽⁶⁾⁽¹⁰⁾ • 15.9 Type X gypsum board⁽⁷⁾ 	1 h	1 h [1.5 h] ⁽⁸⁾	61	
	W14b	<ul style="list-style-type: none"> • W14 with • 89 mm thick absorptive material on each side⁽⁶⁾⁽¹⁰⁾ • 12.7 Type X gypsum board⁽⁷⁾ 	45 min	1 h	61	
	W14c	<ul style="list-style-type: none"> • W14 with • 89 mm thick absorptive material on one side only⁽⁶⁾⁽¹⁰⁾ • 15.9 Type X gypsum board⁽⁷⁾ 	1 h	1 h	57	
	W14d	<ul style="list-style-type: none"> • W14 with • 89 mm thick absorptive material on one side only⁽⁶⁾⁽¹⁰⁾ • 12.7 Type X gypsum board⁽⁷⁾ 	45 min	1 h	57	
	W14e	<ul style="list-style-type: none"> • W14 with • no absorptive material • 15.9 Type X gypsum board⁽⁷⁾ 	1 h	1 h	51	
	W14f	<ul style="list-style-type: none"> • W14 with • no absorptive material • 12.7 Type X gypsum board⁽⁷⁾ 	45 min	1 h	51	
	W15	<ul style="list-style-type: none"> • two rows 38 mm x 89 mm wood studs each spaced 406 mm or 610 mm o.c. on separate 38 mm x 89 mm plates set 25 mm apart • with or without absorptive material • 2 layers of gypsum board on each side 				
	W15a	<ul style="list-style-type: none"> • W15 with • 89 mm thick absorptive material on each side⁽⁶⁾⁽¹⁰⁾ • 15.9 mm Type X gypsum board⁽⁷⁾ 	1.5 h	2 h	66	
	W15b	<ul style="list-style-type: none"> • W6 with • 89 mm thick absorptive material on each side⁽⁶⁾⁽¹⁰⁾ • 12.7 mm Type X gypsum board⁽⁷⁾ 	1 h	1.5 h	65	
	W15c	<ul style="list-style-type: none"> • W15 with • 89 mm thick absorptive material on each side⁽⁶⁾⁽¹⁰⁾ • 12.7 mm regular gypsum board⁽⁷⁾ 	45 min	1 h	61	
	Column 1	2	3	4	5	6

Table 1 (Cont'd)
Fire and Sound Resistance of Walls⁽¹⁾

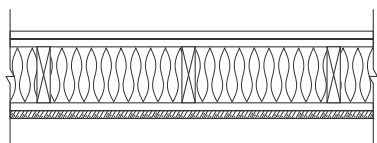
Type of Wall	Wall Number	Description	Fire-Resistance Rating ⁽²⁾⁽³⁾		Typical Sound Transmission Class ⁽²⁾⁽⁴⁾⁽⁵⁾ (STC)
			Loadbearing	Non-Loadbearing	
<ul style="list-style-type: none"> • Wood Studs • Two Rows on Separate Plates • Loadbearing or Non-Loadbearing 	W15d	W15 with <ul style="list-style-type: none"> • 89 mm thick absorptive material on one side only⁽⁶⁾⁽¹⁰⁾ • 15.9 mm Type X gypsum board⁽⁷⁾ 	1.5 h	2 h	62
	W15e	W15 with <ul style="list-style-type: none"> • 89 mm thick absorptive material on one side only⁽⁶⁾⁽¹⁰⁾ • 12.7 mm Type X gypsum board⁽⁷⁾ 	1 h	1.5 h	60
	W15f	W15 with <ul style="list-style-type: none"> • 89 mm thick absorptive material on one side only⁽⁶⁾⁽¹⁰⁾ • 12.7 mm regular gypsum board⁽⁷⁾ 	45 min	1 h	57
	W15g	W15 with <ul style="list-style-type: none"> • no absorptive material • 15.9 mm Type X gypsum board⁽⁷⁾ 	1.5 h	2 h	56
	W15h	W15 with <ul style="list-style-type: none"> • no absorptive material • 12.7 mm Type X gypsum board⁽⁷⁾ 	1 h	1.5 h	55
	W15i	W15 with <ul style="list-style-type: none"> • no absorptive material • 12.7 mm regular gypsum board⁽⁷⁾ 	45 min	1 h	51
<ul style="list-style-type: none"> • Exterior Wood Studs • Single Row • Loadbearing and Non-Loadbearing 	EW1	<ul style="list-style-type: none"> • 38 mm x 89 mm wood studs spaced 406 mm or 610 mm o.c. • 89 mm thick absorptive material⁽⁸⁾ • 1 or 2 layers of gypsum board on inside 			
	EW1a	EW1 with <ul style="list-style-type: none"> • 15.9 mm Type X gypsum board⁽⁷⁾⁽¹¹⁾ • exterior sheathing and cladding⁽¹²⁾ 	1 h	1 h	N/A
	EW1b	EW1 with <ul style="list-style-type: none"> • 12.7 mm Type X gypsum board⁽⁷⁾⁽¹¹⁾ • exterior sheathing and cladding⁽¹²⁾ 	45 min	45 min	N/A
	EW1c	EW1 with <ul style="list-style-type: none"> • 2 layers of 12.7 mm regular gypsum board⁽⁷⁾⁽¹¹⁾ • exterior sheathing and cladding⁽¹²⁾ 	45 min	45 min	N/A
	EW1d	EW1 with <ul style="list-style-type: none"> • 1 layer of 12.7 mm regular gypsum board⁽⁷⁾⁽¹¹⁾ • exterior sheathing⁽¹³⁾ • masonry veneer cladding 	45 min	45 min	N/A
Column 1	2	3	4	5	6

Table 1 (Cont'd)
Fire and Sound Resistance of Walls⁽¹⁾


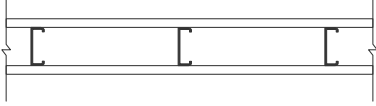
Type of Wall	Wall Number	Description	Fire-Resistance Rating ⁽²⁾⁽³⁾		Typical Sound Transmission Class ⁽²⁾⁽⁴⁾⁽⁵⁾ (STC)
			Loadbearing	Non-Loadbearing	
<ul style="list-style-type: none"> • Exterior Wood Studs • Single Row • Loadbearing and Non-Loadbearing 	EW2	<ul style="list-style-type: none"> • 38 mm x 89 mm or 38 mm x 140 mm wood studs spaced 406 mm or 610 mm o.c. • 89 mm thick glass fiber insulation⁽¹⁴⁾ • 1 layer of gypsum board on inside 			
	EW2a	EW2 with <ul style="list-style-type: none"> • 38 mm x 89 mm studs spaced not more than 406 mm o.c. • 15.9 mm Type X gypsum board⁽⁷⁾⁽¹¹⁾ • exterior sheathing and cladding⁽¹²⁾ 	1 h	1 h	N/A
	EW2b	EW2 with <ul style="list-style-type: none"> • 38 mm x 89 mm studs spaced not more than 406 mm o.c. • 12.7 mm Type X gypsum board⁽⁷⁾⁽¹¹⁾ • exterior sheathing⁽¹³⁾ • masonry veneer cladding 	45 min	45 min	N/A
	EW2c	EW2 with <ul style="list-style-type: none"> • 38 mm x 140 mm studs spaced not more than 610 mm o.c. • 15.9 mm Type X gypsum board⁽⁷⁾⁽¹¹⁾ • exterior sheathing and cladding⁽¹²⁾ 	45 min	45 min	N/A
<ul style="list-style-type: none"> • Non-Loadbearing Steel Studs • 0.46 mm (25 Gauge) 	S1	<ul style="list-style-type: none"> • 31 mm x 64 mm steel studs spaced 406 mm or 610 mm o.c. • with or without absorptive material • 1 layer of gypsum board on each side 			
	S1a	S1 with <ul style="list-style-type: none"> • studs spaced 610 mm o.c. • 65 mm thick absorptive material⁽⁶⁾ • 15.9 mm Type X gypsum board⁽⁷⁾ 	—	45 min [1 h] ⁽⁸⁾	43
	S1b	S1 with <ul style="list-style-type: none"> • studs spaced 406 mm o.c. • 65 mm thick absorptive material⁽⁶⁾ • 15.9 mm Type X gypsum board⁽⁷⁾ 	—	45 min [1 h] ⁽⁸⁾	39
	S1c	S1 with <ul style="list-style-type: none"> • studs spaced 406 mm or 610 mm o.c. • no absorptive material • 15.9 mm Type X gypsum board⁽⁷⁾ 	—	45 min	35
Column 1	2	3	4	5	6

Table 1 (Cont'd)
Fire and Sound Resistance of Walls⁽¹⁾

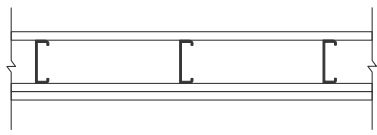
Type of Wall	Wall Number	Description	Fire-Resistance Rating ⁽²⁾⁽³⁾		Typical Sound Transmission Class ⁽²⁾⁽⁴⁾⁽⁵⁾ (STC)
			Loadbearing	Non-Loadbearing	
<ul style="list-style-type: none"> • Non-Loadbearing Steel Studs • 0.46 mm (25 Gauge) 	S2	<ul style="list-style-type: none"> • 31 mm x 64 mm steel studs spaced 406 mm or 610 mm o.c. • with or without absorptive material • 1 layer of gypsum board on one side • 2 layers of gypsum board on other side 			
	S2a	<ul style="list-style-type: none"> • S2 with studs spaced 610 mm o.c. • 65 mm thick absorptive material⁽⁶⁾ • 15.9 mm Type X gypsum board⁽⁷⁾ 	—	1 h	50
	S2b	<ul style="list-style-type: none"> • S2 with studs spaced 406 mm o.c. • 65 mm thick absorptive material⁽⁶⁾ • 15.9 mm Type X gypsum board⁽⁷⁾ 	—	1 h	44
	S2c	<ul style="list-style-type: none"> • S2 with studs spaced 610 mm o.c. • 65 mm thick absorptive material⁽⁶⁾ • 12.7 mm Type X gypsum board⁽⁷⁾ 	—	1 h	50
	S2d	<ul style="list-style-type: none"> • S2 with studs spaced 406 mm o.c. • 65 mm thick absorptive material⁽⁶⁾ • 12.7 mm Type X gypsum board⁽⁷⁾ 	—	1 h	42
	S2e	<ul style="list-style-type: none"> • S2 with studs spaced 610 mm o.c. • no absorptive material • 15.9 mm Type X gypsum board⁽⁷⁾ 	—	1 h	41
	S2f	<ul style="list-style-type: none"> • S2 with studs spaced 406 mm o.c. • no absorptive material • 15.9 mm Type X gypsum board⁽⁷⁾ 	—	1 h	37
	S2g	<ul style="list-style-type: none"> • S2 with studs spaced 610 mm o.c. • no absorptive material • 12.7 mm Type X gypsum board⁽⁷⁾ 	—	1 h	40
	S2h	<ul style="list-style-type: none"> • S2 with studs spaced 406 mm o.c. • no absorptive material • 12.7 mm Type X gypsum board⁽⁷⁾ 	—	1 h	35
Column 1	2	3	4	5	6

Table 1 (Cont'd)
Fire and Sound Resistance of Walls⁽¹⁾

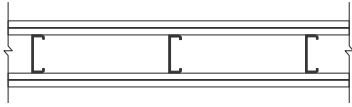
Type of Wall	Wall Number	Description	Fire-Resistance Rating ⁽²⁾⁽³⁾		Typical Sound Transmission Class ⁽²⁾⁽⁴⁾⁽⁵⁾ (STC)
			Loadbearing	Non-Loadbearing	
<ul style="list-style-type: none"> • Non-Loadbearing Steel Studs • 0.46 mm (25 Gauge) 	S3	<ul style="list-style-type: none"> • 31 mm x 64 mm steel studs spaced 406 mm or 610 mm o.c. • with or without absorptive material • 2 layers of gypsum board on each side 			
	S3a	S3 with <ul style="list-style-type: none"> • studs spaced 610 mm o.c. • 65 mm thick absorptive material⁽⁶⁾ • 15.9 mm Type X gypsum board⁽⁷⁾ 	—	2 h	54
	S3b	S3 with <ul style="list-style-type: none"> • studs spaced 406 mm o.c. • 65 mm thick absorptive material⁽⁶⁾ • 15.9 mm Type X gypsum board⁽⁷⁾ 	—	2 h	51
	S3c	S3 with <ul style="list-style-type: none"> • studs spaced 610 mm o.c. • 65 mm thick absorptive material⁽⁶⁾ • 12.7 mm Type X gypsum board⁽⁷⁾ 	—	1.5 h	53
	S3d	S3 with <ul style="list-style-type: none"> • studs spaced 406 mm o.c. • 65 mm thick absorptive material⁽⁶⁾ • 12.7 mm Type X gypsum board⁽⁷⁾ 	—	1.5 h	47
	S3e	S3 with <ul style="list-style-type: none"> • studs spaced 610 mm o.c. • 65 mm thick absorptive material⁽⁶⁾ • 12.7 mm regular gypsum board⁽⁷⁾ 	—	1 h	49
	S3f	S3 with <ul style="list-style-type: none"> • studs spaced 406 mm o.c. • 65 mm thick absorptive material⁽⁶⁾ • 12.7 mm regular gypsum board⁽⁷⁾ 	—	1 h	41
	S3g	S3 with <ul style="list-style-type: none"> • studs spaced 610 mm o.c. • no absorptive material • 15.9 mm Type X gypsum board⁽⁷⁾ 	—	2 h	45
	S3h	S3 with <ul style="list-style-type: none"> • studs spaced 406 mm o.c. • no absorptive material • 15.9 mm Type X gypsum board⁽⁷⁾ 	—	2 h	42
	S3i	S3 with <ul style="list-style-type: none"> • studs spaced 610 mm o.c. • no absorptive material • 12.7 mm Type X gypsum board⁽⁷⁾ 	—	1.5 h	44
	S3j	S3 with <ul style="list-style-type: none"> • studs spaced 406 mm o.c. • no absorptive material • 12.7 mm Type X gypsum board⁽⁷⁾ 	—	1.5 h	39
	Column 1	2	3	4	5

Table 1 (Cont'd)
Fire and Sound Resistance of Walls⁽¹⁾

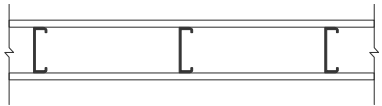
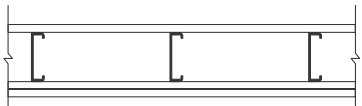
Type of Wall	Wall Number	Description	Fire-Resistance Rating ⁽²⁾⁽³⁾		Typical Sound Transmission Class ⁽²⁾⁽⁴⁾⁽⁵⁾ (STC)
			Loadbearing	Non-Loadbearing	
<ul style="list-style-type: none"> • Non-Loadbearing Steel Studs • 0.46 mm (25 Gauge) 	S3k	S3 with <ul style="list-style-type: none"> • studs spaced 610 mm o.c. • no absorptive material • 12.7 mm regular gypsum board⁽⁷⁾ 	—	1 h	40
	S3l	S3 with <ul style="list-style-type: none"> • studs spaced 406 mm o.c. • no absorptive material • 12.7 mm regular gypsum board⁽⁷⁾ 	—	1 h	37
	S4	<ul style="list-style-type: none"> • 31 mm x 92 mm steel studs spaced 406 mm or 610 mm o.c. • with or without absorptive material • 1 layer of gypsum board on each side 			
	S4a	S4 with <ul style="list-style-type: none"> • studs spaced 610 mm o.c. • 89 mm thick absorptive material⁽⁶⁾ • 15.9 mm Type X gypsum board⁽⁷⁾ 	—	45 min [1 h] ⁽⁸⁾	48
	S4b	S4 with <ul style="list-style-type: none"> • studs spaced 406 mm o.c. • 89 mm thick absorptive material⁽⁶⁾ • 15.9 mm Type X gypsum board⁽⁷⁾ 	—	45 min [1 h] ⁽⁸⁾	47
	S4c	S4 with <ul style="list-style-type: none"> • studs spaced 610 mm o.c. • no absorptive material • 15.9 mm Type X gypsum board⁽⁷⁾ 	—	45 min	38
	S4d	S4 with <ul style="list-style-type: none"> • studs spaced 406 mm o.c. • no absorptive material • 15.9 mm Type X gypsum board⁽⁷⁾ 	—	45 min	38
	S5	<ul style="list-style-type: none"> • 31 mm x 92 mm steel studs spaced 406 mm or 610 mm o.c. • with or without absorptive material • 1 layer of gypsum board on one side • 2 layers of gypsum board on other side 			
	S5a	S5 with <ul style="list-style-type: none"> • studs spaced 610 mm o.c. • 89 mm thick absorptive material⁽⁶⁾ • 15.9 mm Type X gypsum board⁽⁷⁾ 	—	1 h [1.5 h] ⁽⁸⁾	53
	S5b	S5 with <ul style="list-style-type: none"> • studs spaced 406 mm o.c. • 89 mm thick absorptive material⁽⁶⁾ • 15.9 mm Type X gypsum board⁽⁷⁾ 	—	1 h [1.5 h] ⁽⁸⁾	52
	Column 1	2	3	4	5

Table 1 (Cont'd)
Fire and Sound Resistance of Walls⁽¹⁾

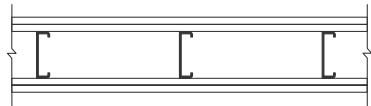
Type of Wall	Wall Number	Description	Fire-Resistance Rating ⁽²⁾⁽³⁾		Typical Sound Transmission Class ⁽²⁾⁽⁴⁾⁽⁵⁾ (STC)
			Loadbearing	Non-Loadbearing	
<ul style="list-style-type: none"> • Non-Loadbearing Steel Studs • 0.46 mm (25 Gauge) 	S5c	S5 with <ul style="list-style-type: none"> • studs spaced 610 mm o.c. • 89 mm thick absorptive material⁽⁶⁾ • 12.7 mm Type X gypsum board⁽⁷⁾ 	—	1 h [1.5 h] ⁽⁸⁾	51
	S5d	S5 with <ul style="list-style-type: none"> • studs spaced 406 mm o.c. • 89 mm thick absorptive material⁽⁶⁾ • 12.7 mm Type X gypsum board⁽⁷⁾ 	—	1 h [1.5 h] ⁽⁸⁾	50
	S5e	S5 with <ul style="list-style-type: none"> • studs spaced 610 mm o.c. • no absorptive material • 15.9 mm Type X gypsum board⁽⁷⁾ 	—	1 h	43
	S5f	S5 with <ul style="list-style-type: none"> • studs spaced 406 mm o.c. • no absorptive material • 15.9 mm Type X gypsum board⁽⁷⁾ 	—	1 h	42
	S5g	S5 with <ul style="list-style-type: none"> • studs spaced 610 mm o.c. • no absorptive material • 12.7 mm Type X gypsum board⁽⁷⁾ 	—	1 h	41
	S5h	S5 with <ul style="list-style-type: none"> • studs spaced 406 mm o.c. • no absorptive material • 12.7 mm Type X gypsum board⁽⁷⁾ 	—	1 h	40
	S6	<ul style="list-style-type: none"> • 31 mm x 92 mm steel studs spaced 406 mm or 610 mm o.c. • with or without absorptive material • 2 layers of gypsum board on each side 			
	S6a	S6 with <ul style="list-style-type: none"> • studs spaced 610 mm o.c. • 89 mm thick absorptive material⁽⁶⁾ • 15.9 mm Type X gypsum board⁽⁷⁾ 	—	2 h	56
	S6b	S6 with <ul style="list-style-type: none"> • studs spaced 406 mm o.c. • 89 mm thick absorptive material⁽⁶⁾ • 15.9 mm Type X gypsum board⁽⁷⁾ 	—	2 h	55
	Column 1	2	3	4	5

Table 1 (Cont'd)
Fire and Sound Resistance of Walls⁽¹⁾

Type of Wall	Wall Number	Description	Fire-Resistance Rating ⁽²⁾⁽³⁾		Typical Sound Transmission Class ⁽²⁾⁽⁴⁾⁽⁵⁾ (STC)
			Loadbearing	Non-Loadbearing	
<ul style="list-style-type: none"> • Non-Loadbearing Steel Studs • 0.46 mm (25 Gauge) 	S6c	S6 with <ul style="list-style-type: none"> • studs spaced 610 mm o.c. • 89 mm thick absorptive material⁽⁶⁾ • 12.7 mm Type X gypsum board⁽⁷⁾ 	—	1.5 h	55
	S6d	S6 with <ul style="list-style-type: none"> • studs spaced 406 mm o.c. • 89 mm thick absorptive material⁽⁶⁾ • 12.7 mm Type X gypsum board⁽⁷⁾ 	—	1.5 h	54
	S6e	S6 with <ul style="list-style-type: none"> • studs spaced 610 mm o.c. • 89 mm thick absorptive material⁽⁶⁾ • 12.7 mm regular gypsum board⁽⁷⁾ 	—	1 h	50
	S6f	S6 with <ul style="list-style-type: none"> • studs spaced 406 mm o.c. • 89 mm thick absorptive material⁽⁶⁾ • 12.7 mm regular gypsum board⁽⁷⁾ 	—	1 h	48
	S6g	S6 with <ul style="list-style-type: none"> • studs spaced 610 mm o.c. • no absorptive material • 15.9 mm Type X gypsum board⁽⁷⁾ 	—	2 h	47
	S6h	S6 with <ul style="list-style-type: none"> • studs spaced 406 mm o.c. • no absorptive material • 15.9 mm Type X gypsum board⁽⁷⁾ 	—	2 h	45
	S6i	S6 with <ul style="list-style-type: none"> • studs spaced 610 mm o.c. • no absorptive material • 12.7 mm Type X gypsum board⁽⁷⁾ 	—	1.5 h	45
	S6j	S6 with <ul style="list-style-type: none"> • studs spaced 406 mm o.c. • no absorptive material • 12.7 mm Type X gypsum board⁽⁷⁾ 	—	1.5 h	44
	S6k	S6 with <ul style="list-style-type: none"> • studs spaced 610 mm o.c. • no absorptive material • 12.7 mm regular gypsum board⁽⁷⁾ 	—	1 h	41
	S6l	S6 with <ul style="list-style-type: none"> • studs spaced 406 mm o.c. • no absorptive material • 12.7 mm regular gypsum board⁽⁷⁾ 	—	1 h	39
Column 1	2	3	4	5	6

Table 1 (Cont'd)
Fire and Sound Resistance of Walls⁽¹⁾

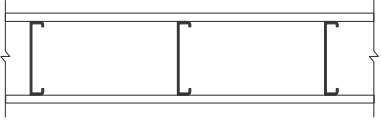
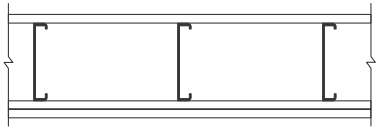
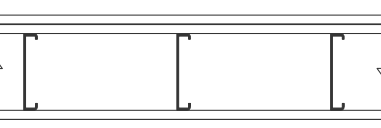
Type of Wall	Wall Number	Description	Fire-Resistance Rating ⁽²⁾⁽³⁾		Typical Sound Transmission Class ⁽²⁾⁽⁴⁾⁽⁵⁾ (STC)
			Loadbearing	Non-Loadbearing	
<ul style="list-style-type: none"> • Non-Loadbearing Steel Studs • 0.46 mm (25 Gauge) 	S7	<ul style="list-style-type: none"> • 31 mm x 152 mm steel studs spaced 406 mm or 610 mm o.c. • with or without absorptive material • 1 layer of gypsum board on each side 			
	S7a	S7 with <ul style="list-style-type: none"> • 150 mm thick absorptive material⁽⁶⁾ • 15.9 mm Type X gypsum board⁽⁷⁾ 	—	45 min [1 h] ⁽⁸⁾	51
	S7b	S7 with <ul style="list-style-type: none"> • no absorptive material • 15.9 mm Type X gypsum board⁽⁷⁾ 	—	45 min	41
	S8	<ul style="list-style-type: none"> • 31 mm x 152 mm steel studs spaced 406 mm or 610 mm o.c. • with or without absorptive material • 1 layer of gypsum board on one side • 2 layers of gypsum board on other side 			
	S8a	S8 with <ul style="list-style-type: none"> • 150 mm thick absorptive material⁽⁶⁾ • 15.9 mm Type X gypsum board⁽⁷⁾ 	—	1 h [1.5 h] ⁽⁸⁾	55
	S8b	S8 with <ul style="list-style-type: none"> • 150 mm thick absorptive material⁽⁶⁾ • 12.7 mm Type X gypsum board⁽⁷⁾ 	—	1 h [1.5 h] ⁽⁸⁾	54
	S8c	S8 with <ul style="list-style-type: none"> • no absorptive material • 15.9 mm Type X gypsum board⁽⁷⁾ 	—	1 h	45
	S8d	S8 with <ul style="list-style-type: none"> • no absorptive material • 12.7 mm Type X gypsum board⁽⁷⁾ 	—	1 h	44
	S9	<ul style="list-style-type: none"> • 31 mm x 152 mm steel studs spaced 406 mm or 610 mm o.c. • with or without absorptive material • 2 layers of gypsum board on each side 			
	S9a	S9 with <ul style="list-style-type: none"> • 150 mm thick absorptive material⁽⁶⁾ • 15.9 mm Type X gypsum board⁽⁷⁾ 	—	2 h	59
	S9b	S9 with <ul style="list-style-type: none"> • 150 mm thick absorptive material⁽⁶⁾ • 12.7 mm Type X gypsum board⁽⁷⁾ 	—	1.5 h	57
	Column 1	2	3	4	5

Table 1 (Cont'd)
Fire and Sound Resistance of Walls⁽¹⁾

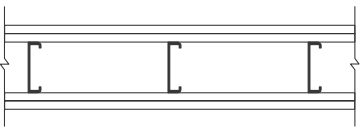
Type of Wall	Wall Number	Description	Fire-Resistance Rating ⁽²⁾⁽³⁾		Typical Sound Transmission Class ⁽²⁾⁽⁴⁾⁽⁵⁾ (STC)
			Loadbearing	Non-Loadbearing	
<ul style="list-style-type: none"> • Non-Loadbearing Steel Studs • 0.46 mm (25 Gauge) 	S9c	S9 with <ul style="list-style-type: none"> • 150 mm thick absorptive material⁽⁶⁾ • 12.7 mm regular gypsum board⁽⁷⁾ 	—	1 h	53
	S9d	S9 with <ul style="list-style-type: none"> • no absorptive material • 15.9 mm Type X gypsum board⁽⁷⁾ 	—	2 h	49
	S9e	S9 with <ul style="list-style-type: none"> • no absorptive material • 12.7 mm Type X gypsum board⁽⁷⁾ 	—	1.5 h	47
	S9f	S9 with <ul style="list-style-type: none"> • no absorptive material • 12.7 mm regular gypsum board⁽⁷⁾ 	—	1 h	43
<ul style="list-style-type: none"> • Loadbearing Steel Studs • 0.84 mm to 1.52 mm thickness 	S10	<ul style="list-style-type: none"> • 41 mm x 92 mm loadbearing steel studs spaced 406 mm or 610 mm o.c. • with or without cross-bracing on one side • with or without absorptive material • 2 layers of gypsum board on each side 			
	S10a	S10 with <ul style="list-style-type: none"> • 89 mm thick absorptive material⁽⁶⁾ • 15.9 mm Type X gypsum board⁽⁷⁾ 	1 h	—	38
	S10b	S10 with <ul style="list-style-type: none"> • 89 mm thick absorptive material⁽⁶⁾ • 12.7 mm Type X gypsum board⁽⁷⁾ 	45 min [1 h] ⁽⁸⁾	—	38
	S10c	S10 with <ul style="list-style-type: none"> • 89 mm thick absorptive material⁽⁶⁾ • 12.7 mm regular gypsum board⁽⁷⁾ 	—	—	36
	S10d	S10 with <ul style="list-style-type: none"> • no absorptive material • 15.9 mm Type X gypsum board⁽⁷⁾ 	1 h	—	36
	S10e	S10 with <ul style="list-style-type: none"> • no absorptive material • 12.7 mm Type X gypsum board⁽⁷⁾ 	1 h	—	35
	S10f	S10 with <ul style="list-style-type: none"> • no absorptive material • 12.7 mm regular gypsum board⁽⁷⁾ 	—	—	34
Column 1	2	3	4	5	6

Table 1 (Cont'd)
Fire and Sound Resistance of Walls⁽¹⁾

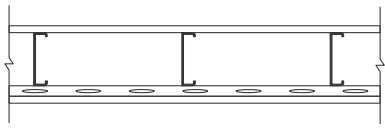
Type of Wall	Wall Number	Description	Fire-Resistance Rating ⁽²⁾⁽³⁾		Typical Sound Transmission Class ⁽²⁾⁽⁴⁾⁽⁵⁾ (STC)
			Loadbearing	Non-Loadbearing	
<ul style="list-style-type: none"> • Loadbearing Steel Studs • 0.84 mm to 1.52 mm thickness 	S11	<ul style="list-style-type: none"> • 41 mm x 92 mm loadbearing steel studs spaced 406 mm or 610 mm o.c. • with or without cross-bracing on one side • with or without absorptive material • resilient metal channels on one side • 1 layer of gypsum board on each side 			
	S11a	<ul style="list-style-type: none"> • S11 with • 89 mm thick absorptive material⁽⁶⁾ • resilient metal channels spaced at 610 mm o.c. • 15.9 mm Type X gypsum board⁽⁷⁾ 	—	—	50
	S11b	<ul style="list-style-type: none"> • S11 with • 89 mm thick absorptive material⁽⁶⁾ • resilient metal channels spaced at 406 mm o.c. • 15.9 mm Type X gypsum board⁽⁷⁾ 	—	—	47
	S11c	<ul style="list-style-type: none"> • S11 with • no absorptive material • resilient metal channels spaced at 610 mm o.c. • 15.9 mm Type X gypsum board⁽⁷⁾ 	—	—	41
	S11d	<ul style="list-style-type: none"> • S11 with • no absorptive material • resilient metal channels spaced at 406 mm o.c. • 15.9 mm Type X gypsum board⁽⁷⁾ 	—	—	39
	S11e	<ul style="list-style-type: none"> • S11 with • 89 mm thick absorptive material⁽⁶⁾ • resilient metal channels spaced at 610 mm o.c. • 12.7 mm Type X gypsum board⁽⁷⁾ 	—	—	47
	S11f	<ul style="list-style-type: none"> • S11 with • 89 mm thick absorptive material⁽⁶⁾ • resilient metal channels spaced at 406 mm o.c. • 12.7 mm Type X gypsum board⁽⁷⁾ 	—	—	45
	S11g	<ul style="list-style-type: none"> • S11 with • no absorptive material • resilient metal channels spaced at 610 mm o.c. • 12.7 mm Type X gypsum board⁽⁷⁾ 	—	—	38
	S11h	<ul style="list-style-type: none"> • S11 with • no absorptive material • resilient metal channels spaced at 406 mm o.c. • 12.7 mm Type X gypsum board⁽⁷⁾ 	—	—	36
Column 1	2	3	4	5	6

Table 1 (Cont'd)
Fire and Sound Resistance of Walls⁽¹⁾

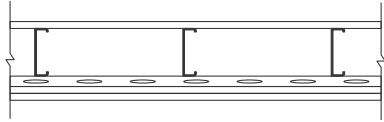
Type of Wall	Wall Number	Description	Fire-Resistance Rating ⁽²⁾⁽³⁾		Typical Sound Transmission Class ⁽²⁾⁽⁴⁾⁽⁵⁾ (STC)
			Loadbearing	Non-Loadbearing	
<ul style="list-style-type: none"> • Loadbearing Steel Studs • 0.84 mm to 1.52 mm thickness 	S12	<ul style="list-style-type: none"> • 41 mm x 92 mm loadbearing steel studs spaced 406 mm or 610 mm o.c. • with or without cross-bracing on one side • with or without absorptive material • resilient metal channels on one side • 2 layers of gypsum board on resilient channel side • 1 layer of gypsum board on other side 			
	S12a	S12 with <ul style="list-style-type: none"> • 89 mm thick absorptive material⁽⁶⁾ • resilient metal channels spaced at 610 mm o.c. • 15.9 mm Type X gypsum board⁽⁷⁾ 	—	—	54
	S12b	S12 with <ul style="list-style-type: none"> • 89 mm thick absorptive material⁽⁶⁾ • resilient metal channels spaced at 406 mm o.c. • 15.9 mm Type X gypsum board⁽⁷⁾ 	—	—	52
	S12c	S12 with <ul style="list-style-type: none"> • no absorptive material • resilient metal channels spaced at 610 mm o.c. • 15.9 mm Type X gypsum board⁽⁷⁾ 	—	—	46
	S12d	S12 with <ul style="list-style-type: none"> • no absorptive material • resilient metal channels spaced at 406 mm o.c. • 15.9 mm Type X gypsum board⁽⁷⁾ 	—	—	43
	S12e	S12 with <ul style="list-style-type: none"> • 89 mm thick absorptive material⁽⁶⁾ • resilient metal channels spaced at 610 mm o.c. • 12.7 mm Type X gypsum board⁽⁷⁾ 	—	—	52
	S12f	S12 with <ul style="list-style-type: none"> • 89 mm thick absorptive material⁽⁶⁾ • resilient metal channels spaced at 406 mm o.c. • 12.7 mm Type X gypsum board⁽⁷⁾ 	—	—	50
	S12g	S12 with <ul style="list-style-type: none"> • no absorptive material • resilient metal channels spaced at 610 mm o.c. • 12.7 mm Type X gypsum board⁽⁷⁾ 	—	—	43
	S12h	S12 with <ul style="list-style-type: none"> • no absorptive material • resilient metal channels spaced at 406 mm o.c. • 12.7 mm Type X gypsum board⁽⁷⁾ 	—	—	41
Column 1	2	3	4	5	6

Table 1 (Cont'd)
Fire and Sound Resistance of Walls⁽¹⁾

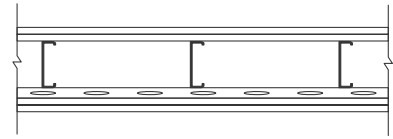
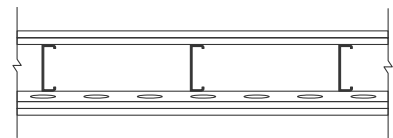
Type of Wall	Wall Number	Description	Fire-Resistance Rating ⁽²⁾⁽³⁾		Typical Sound Transmission Class ⁽²⁾⁽⁴⁾⁽⁵⁾ (STC)
			Loadbearing	Non-Loadbearing	
<ul style="list-style-type: none"> • Loadbearing Steel Studs • 0.84 mm to 1.52 mm thickness 	S13	<ul style="list-style-type: none"> • 41 mm x 92 mm loadbearing steel studs spaced 406 mm or 610 mm o.c. • with or without absorptive material • resilient metal channels on one side spaced at 406 mm o.c. • 2 layers of gypsum board on resilient channel side • 1 layer shear membrane and 1 layer gypsum board on other side 			
	S13a	S13 with <ul style="list-style-type: none"> • 89 mm thick absorptive material⁽⁶⁾ • 12.7 mm OSB shear membrane • 12.7 mm Type X gypsum board⁽⁷⁾ 	30 min	—	57
	S14	<ul style="list-style-type: none"> • 41 mm x 92 mm loadbearing steel studs spaced 406 mm or 610 mm o.c. • with or without absorptive material • resilient metal channels on one side • 2 layers of gypsum board on each side 			
	S14a	S14 with <ul style="list-style-type: none"> • 89 mm thick absorptive material⁽⁶⁾ • resilient metal channels spaced at 610 mm o.c. • 15.9 mm Type X gypsum board⁽⁷⁾ 	1 h	—	60
	S14b	S14 with <ul style="list-style-type: none"> • 89 mm thick absorptive material⁽⁶⁾ • resilient metal channels spaced at 610 mm o.c. • 12.7 mm Type X gypsum board⁽⁷⁾ 	45 min [1 h] ⁽⁸⁾	—	57
	S14c	S14 with <ul style="list-style-type: none"> • 89 mm thick absorptive material⁽⁶⁾ • resilient metal channels spaced at 610 mm o.c. • 12.7 mm regular gypsum board⁽⁷⁾ 	—	—	54
	S14d	S14 with <ul style="list-style-type: none"> • 89 mm thick absorptive material • resilient metal channels spaced at 406 mm o.c. • 12.7 mm Type X gypsum board⁽⁷⁾ 	45 min [1 h] ⁽⁸⁾	—	55
	S14e	S14 with <ul style="list-style-type: none"> • no absorptive material • resilient metal channels spaced at 610 mm o.c. • 15.9 mm Type X gypsum board⁽⁷⁾ 	1 h	—	51
	S14f	S14 with <ul style="list-style-type: none"> • no absorptive material • resilient metal channels spaced at 610 mm o.c. • 12.7 mm regular gypsum board⁽⁷⁾ 	—	—	45
	Column 1	2	3	4	5

Table 1 (Cont'd)
Fire and Sound Resistance of Walls⁽¹⁾

Type of Wall	Wall Number	Description	Fire-Resistance Rating ⁽²⁾⁽³⁾		Typical Sound Transmission Class ⁽²⁾⁽⁴⁾⁽⁵⁾ (STC)
			Loadbearing	Non-Loadbearing	
<ul style="list-style-type: none"> • Loadbearing Steel Studs • 0.84 mm to 1.52 mm thickness 	S14g	S14 with <ul style="list-style-type: none"> • no absorptive material • resilient metal channels spaced at 406 mm o.c. • 12.7 mm Type X gypsum board⁽⁷⁾ 	1 h	—	47
	S14h	S14 with <ul style="list-style-type: none"> • studs at 610 mm o.c. • 89 mm thick absorptive material • resilient metal channels spaced at 406 mm o.c. • 15.9 mm Type X gypsum board⁽⁷⁾ 	1 h	—	60
	S14i	S14 with <ul style="list-style-type: none"> • studs at 406 mm o.c. • 89 mm thick absorptive material • resilient metal channels spaced at 406 mm o.c. • 15.9 mm Type X gypsum board⁽⁷⁾ 	1 h	—	58
	S14j	S14 with <ul style="list-style-type: none"> • studs at 610 mm o.c. • no absorptive material • resilient metal channels spaced at 406 mm o.c. • 15.9 mm Type X gypsum board⁽⁷⁾ 	1 h	—	51
	S14k	S14 with <ul style="list-style-type: none"> • studs at 406 mm o.c. • no absorptive material • resilient metal channels spaced at 406 mm o.c. • 15.9 mm Type X gypsum board⁽⁷⁾ 	1 h	—	49
	S14l	S14 with <ul style="list-style-type: none"> • studs at 406 mm o.c. • no absorptive material • resilient metal channels spaced at 610 mm o.c. • 12.7 mm Type X gypsum board⁽⁷⁾ 	1 h	—	49
	S14m	S14 with <ul style="list-style-type: none"> • studs at 610 mm o.c. • no absorptive material • resilient metal channels spaced at 610 mm o.c. • 12.7 mm regular gypsum board⁽⁷⁾ 	1 h	—	50
	S15	<ul style="list-style-type: none"> • 2 rows of 41 mm x 92 mm loadbearing steel studs spaced 406 mm or 610 mm o.c. staggered on 152 mm common plate • with cross-bracing • with or without absorptive material • 2 layers of gypsum board on each side 			
Column 1	2	3	4	5	6

Table 1 (Cont'd)
Fire and Sound Resistance of Walls⁽¹⁾

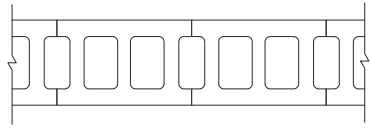
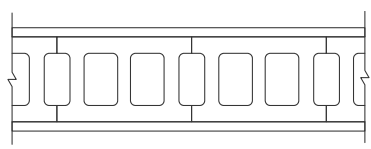
Type of Wall	Wall Number	Description	Fire-Resistance Rating ⁽²⁾⁽³⁾		Typical Sound Transmission Class ⁽²⁾⁽⁴⁾⁽⁵⁾ (STC)
			Loadbearing	Non-Loadbearing	
<ul style="list-style-type: none"> • Loadbearing Steel Studs • 0.84 mm to 1.52 mm thickness 	S15a	S15 with <ul style="list-style-type: none"> • 89 mm thick absorptive material in each cavity • 15.9 mm Type X gypsum board⁽⁷⁾ 	1 h	—	68
	S15b	S15 with <ul style="list-style-type: none"> • 89 mm thick absorptive material in each cavity • 12.7 mm Type X gypsum board⁽⁷⁾ 	1 h	—	68
	S15c	S15 with <ul style="list-style-type: none"> • no absorptive material • 15.9 mm Type X gypsum board⁽⁷⁾ 	1.5 h	—	52
	S15d	S15 with <ul style="list-style-type: none"> • no absorptive material • 12.7 mm Type X gypsum board⁽⁷⁾ 	1 h	—	52
<ul style="list-style-type: none"> • Hollow Concrete Block (Normal Weight Aggregate) 	B1	<ul style="list-style-type: none"> • 140 mm or 190 mm concrete block 			
	B1a	<ul style="list-style-type: none"> • 140 mm bare concrete block⁽⁵⁾ 	1 h	1 h	48
	B1b	<ul style="list-style-type: none"> • 190 mm bare concrete block⁽⁵⁾ 	1.5 h	1.5 h	50
	B2	<ul style="list-style-type: none"> • 140 mm or 190 mm concrete block • no absorptive material • 1 layer of gypsum-sand plaster or gypsum board on each side 			
	B2a	B2 with <ul style="list-style-type: none"> • 140 mm concrete block • 12.7 mm gypsum-sand plaster 	2 h	2 h	50
	B2b	B2 with <ul style="list-style-type: none"> • 140 mm concrete block • 12.7 mm Type X gypsum board or 15.9 mm Type X gypsum board⁽⁷⁾ 	2 h	2 h	47
	B2c	B2 with <ul style="list-style-type: none"> • 140 mm concrete block • 12.7 mm regular gypsum board⁽⁷⁾ 	1.5 h	1.5 h	46
	B2d	B2 with <ul style="list-style-type: none"> • 190 mm concrete block • 12.7 mm gypsum-sand plaster 	2.5 h	2.5 h	51
	B2e	B2 with <ul style="list-style-type: none"> • 190 mm concrete block • 15.9 mm Type X gypsum board⁽⁷⁾ 	3 h	3 h	50
Column 1	2	3	4	5	6

Table 1 (Cont'd)
Fire and Sound Resistance of Walls⁽¹⁾

Type of Wall	Wall Number	Description	Fire-Resistance Rating ⁽²⁾⁽³⁾		Typical Sound Transmission Class ⁽²⁾⁽⁴⁾⁽⁵⁾ (STC)	
			Loadbearing	Non-Loadbearing		
• Hollow Concrete Block (Normal Weight Aggregate)	B2f	B2 with <ul style="list-style-type: none"> • 190 mm concrete block • 12.7 mm Type X gypsum board⁽⁷⁾ 	2.5 h	2.5 h	49	
	B2g	B2 with <ul style="list-style-type: none"> • 190 mm concrete block • 12.7 mm regular gypsum board⁽⁷⁾ 	2 h	2 h	48	
	B3	<ul style="list-style-type: none"> • 140 mm or 190 mm concrete block • resilient metal channels on one side spaced at 406 mm or 610 mm o.c. • absorptive material filling resilient metal channel space⁽⁶⁾ • 1 layer of gypsum board on each side 				
	B3a	B3 with <ul style="list-style-type: none"> • 140 mm concrete block • 12.7 mm Type X gypsum board or 15.9 mm Type X gypsum board⁽⁷⁾ 	2 h	2 h	51	
	B3b	B3 with <ul style="list-style-type: none"> • 140 mm concrete block • 12.7 mm regular gypsum board⁽⁷⁾⁽⁹⁾ 	1.5 h	1.5 h	48	
	B3c	B3 with <ul style="list-style-type: none"> • 190 mm concrete block • 15.9 mm Type X gypsum board⁽⁷⁾ 	3 h	3 h	54	
	B3d	B3 with <ul style="list-style-type: none"> • 190 mm concrete block • 12.7 mm Type X gypsum board⁽⁷⁾ 	2.5 h	2.5 h	53	
	B3e	B3 with <ul style="list-style-type: none"> • 190 mm concrete block • 12.7 mm regular gypsum board⁽⁷⁾⁽⁹⁾ 	2 h	2 h	51	
	B4	<ul style="list-style-type: none"> • 140 mm or 190 mm concrete block • resilient metal channels on each side spaced at 406 mm or 610 mm o.c. • with or without absorptive material • 1 layer of gypsum board on each side 				
	B4a	B4 with <ul style="list-style-type: none"> • 140 mm concrete block • 12.7 mm Type X gypsum board or 15.9 mm Type X gypsum board⁽⁷⁾ 	2 h	2 h	47	
	B4b	B4 with <ul style="list-style-type: none"> • 140 mm concrete block • 12.7 mm regular gypsum board⁽⁷⁾⁽⁹⁾ 	1.5 h	1.5 h	42	
	Column 1	2	3	4	5	6

Table 1 (Cont'd)
Fire and Sound Resistance of Walls⁽¹⁾

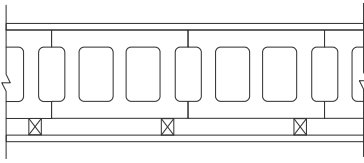
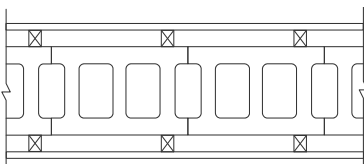
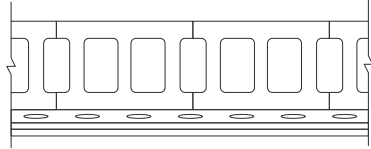
Type of Wall	Wall Number	Description	Fire-Resistance Rating ⁽²⁾⁽³⁾		Typical Sound Transmission Class ⁽²⁾⁽⁴⁾⁽⁵⁾ (STC)
			Loadbearing	Non-Loadbearing	
• Hollow Concrete Block (Normal Weight Aggregate)	B4c	B4 with <ul style="list-style-type: none"> • 190 mm concrete block • 15.9 mm Type X gypsum board⁽⁷⁾ 	3 h	3 h	50
	B4d	B4 with <ul style="list-style-type: none"> • 190 mm concrete block • 12.7 mm Type X gypsum board⁽⁷⁾ 	2.5 h	2.5 h	49
	B4e	B4 with <ul style="list-style-type: none"> • 190 mm concrete block • 12.7 mm regular gypsum board⁽⁷⁾⁽⁹⁾ 	2 h	2 h	45
	B5	<ul style="list-style-type: none"> • 190 mm concrete block • 38 mm x 38 mm horizontal or vertical wood strapping on one side spaced at 610 mm o.c. • with or without absorptive material • 1 layer of gypsum board on each side 			
	B5a	B5 with <ul style="list-style-type: none"> • 15.9 mm Type X gypsum board⁽⁷⁾ 	3 h	3 h	54
	B5b	B5 with <ul style="list-style-type: none"> • 12.7 mm Type X gypsum board⁽⁷⁾ 	2.5 h	2.5 h	53
	B5c	B5 with <ul style="list-style-type: none"> • 12.7 mm regular gypsum board⁽⁷⁾⁽⁹⁾ 	2 h	2 h	51
	B6	<ul style="list-style-type: none"> • 140 mm or 190 mm concrete block • 38 mm x 38 mm horizontal or vertical wood strapping on each side spaced at 610 mm o.c. • absorptive material filling strapping space on each side⁽⁶⁾ • 1 layer of gypsum board on each side 			
	B6a	B6 with <ul style="list-style-type: none"> • 140 mm concrete block • 12.7 mm Type X gypsum board or 15.9 mm Type X gypsum board⁽⁷⁾ 	2 h	2 h	57
	B6b	B6 with <ul style="list-style-type: none"> • 140 mm concrete block • 12.7 mm regular gypsum board⁽⁷⁾⁽⁹⁾ 	1.5 h	1.5 h	56
	B6c	B6 with <ul style="list-style-type: none"> • 190 mm concrete block • 15.9 mm Type X gypsum board⁽⁷⁾ 	3 h	3 h	60
	B6d	B6 with <ul style="list-style-type: none"> • 190 mm concrete block • 12.7 mm Type X gypsum board⁽⁷⁾ 	2.5 h	2.5 h	59
	Column 1	2	3	4	5

Table 1 (Cont'd)
Fire and Sound Resistance of Walls⁽¹⁾

Type of Wall	Wall Number	Description	Fire-Resistance Rating ⁽²⁾⁽³⁾		Typical Sound Transmission Class ⁽²⁾⁽⁴⁾⁽⁵⁾ (STC)	
			Loadbearing	Non-Loadbearing		
• Hollow Concrete Block (Normal Weight Aggregate)	B6e	B6 with <ul style="list-style-type: none"> • 190 mm concrete block • 12.7 mm regular gypsum board⁽⁷⁾⁽⁹⁾ 	2 h	2 h	57	
	B7	<ul style="list-style-type: none"> • 190 mm concrete block • 65 mm steel studs each side spaced at 610 mm o.c. • absorptive material filling stud space on each side⁽⁶⁾ • 1 layer of gypsum board on each side 				
	B7a	B7 with <ul style="list-style-type: none"> • 15.9 mm Type X gypsum board⁽⁷⁾ 	3 h	3 h	71	
	B7b	B7 with <ul style="list-style-type: none"> • 12.7 mm Type X gypsum board⁽⁷⁾ 	2.5 h	2.5 h	70	
	B7c	B7 with <ul style="list-style-type: none"> • 12.7 mm regular gypsum board⁽⁷⁾⁽⁹⁾ 	2 h	2 h	69	
	B8	<ul style="list-style-type: none"> • 190 mm concrete block • 38 mm x 64 mm wood studs on each side spaced at 610 mm o.c. • absorptive material filling stud space on each side⁽⁶⁾ • 1 layer of gypsum board on each side 				
	B8a	B8 with <ul style="list-style-type: none"> • 15.9 mm Type X gypsum board⁽⁷⁾ 	3 h	3 h	71	
	B8b	B8 with <ul style="list-style-type: none"> • 12.7 mm Type X gypsum board⁽⁷⁾ 	2.5 h	2.5 h	70	
	B8c	B8 with <ul style="list-style-type: none"> • 12.7 mm regular gypsum board⁽⁷⁾⁽⁹⁾ 	2 h	2 h	69	
	B9	<ul style="list-style-type: none"> • 190 mm concrete block • 50 mm metal Z-bars on each side spaced at 610 mm o.c. (or 38 mm x 38 mm horizontal or vertical wood strapping plus resilient metal channels) • absorptive material filling Z-bar space on each side⁽⁶⁾ • 1 layer of gypsum board on each side 				
	B9a	B9 with <ul style="list-style-type: none"> • 15.9 mm Type X gypsum board⁽⁷⁾ 	3 h	3 h	65	
	B9b	B9 with <ul style="list-style-type: none"> • 12.7 mm Type X gypsum board⁽⁷⁾ 	2.5 h	2.5 h	64	
	B9c	B9 with <ul style="list-style-type: none"> • 12.7 mm regular gypsum board⁽⁷⁾⁽⁹⁾ 	2 h	2 h	63	
	Column 1	2	3	4	5	6

Table 1 (Cont'd)
Fire and Sound Resistance of Walls⁽¹⁾

Type of Wall	Wall Number	Description	Fire-Resistance Rating ⁽²⁾⁽³⁾		Typical Sound Transmission Class ⁽²⁾⁽⁴⁾⁽⁵⁾ (STC)
			Loadbearing	Non-Loadbearing	
	B10	<ul style="list-style-type: none"> • 190 mm concrete block • resilient metal channels on one side spaced at 610 mm o.c. • absorptive material filling resilient metal channel space⁽⁶⁾ • 2 layers of gypsum board on one side only 			
	B10a	B10 with <ul style="list-style-type: none"> • 15.9 mm Type X gypsum board⁽⁷⁾ 	3 h	3 h	56
	B10b	B10 with <ul style="list-style-type: none"> • 12.7 mm Type X gypsum board⁽⁷⁾ 	2.5 h	2.5 h	55
	B10c	B10 with <ul style="list-style-type: none"> • 12.7 mm regular gypsum board⁽⁷⁾ 	2 h	2 h	54
Column 1	2	3	4	5	6

Notes to Table 1:

- See Figure 1 for butt joint detail of single layer gypsum board application, Figure 2 for butt joint detail of double layer gypsum board application, Figure 3 for example of steel furring channel and Figure 4 for example of resilient metal channel.
- Fire-resistance ratings and STC ratings of wood frame construction were evaluated only for solid sawn 38 mm x 89 mm lumber. However, the fire-resistance ratings and STC ratings provided for 38 mm x 89 mm wood frame construction may be applied to 38 mm x 140 mm wood frame construction with solid sawn 38 mm x 140 mm lumber; in some cases the ratings may be conservative. Where 38 mm x 140 mm framing is used and absorptive material is called for, the absorptive material must be 140 mm thick. (See 1.2.1.(2) in MMAH Supplementary Standard SB-2 for the significance of fire-resistance ratings).

The STC ratings may also be applied to fingerjoined lumber. The fire-resistance ratings are applicable to wall assemblies using fingerjoined lumber that has been manufactured with a heat-resistant adhesive (HRA) in accordance with NLGA special product standard SPS-1-2013, "Fingerjoined Structural Lumber", or SPS-3-2013, "Fingerjoined 'Vertical Stud Use Only' Lumber". (See also Appendix Note A-9.23.10.4.(1) under Division B in Appendix A of the Building Code).
- For all fire-resistance ratings, the given spacing for framing is a maximum value.
- Sound ratings listed are based on the most reliable laboratory test data available for specimens conforming to installation details required by CSA A82.31-M1980, "Gypsum Board Application". Results of specific tests may differ slightly because of measurement precision and minor variations in construction details. These results should only be used where the actual construction details, including spacing or fasteners and supporting framing, correspond exactly to the details of the test specimens on which the ratings are based. Assemblies with sound transmission class ratings of 50 or more require acoustical sealant applied around electrical boxes and other openings, and at the junction of intersecting walls and floors, except intersection of walls constructed of concrete or solid masonry units where the masonry joints at the intersection are mortared.
- Sound ratings are only valid where there are no discernible cracks or voids in the visible surfaces. For concrete block walls, surfaces must be sealed by at least 2 coats of paint or other surface finish described in Section 9.29. of Division B of the Building Code to prevent sound leakage.

- (6) Sound absorptive material includes fibre processed from rock, slag, glass or cellulose fibre. It must fill at least 90% of the cavity thickness for the wall to provide the listed STC value. The absorptive material should not overfill the cavity to the point of producing significant outward pressure on the finishes; such an assembly will not achieve the STC rating. Where the absorptive material used with steel stud assemblies is in batt form, "steel stud batts", which are wide enough to fill the cavity from the web of one stud to the web of the adjacent studs, must be used.
- (7) The complete descriptions of indicated finishes are as follows:
- 12.7 mm regular gypsum board — 12.7 mm regular gypsum board conforming to Article 9.29.5.2. of Division B of the Building Code.
 - 12.7 mm Type X gypsum board — 12.7 mm special fire-resistant Type X gypsum board conforming to Article 9.29.5.2. of Division B of the Building Code.
 - 15.9 mm Type X gypsum board — 15.9 mm special fire-resistant Type X gypsum board conforming to Article 9.29.5.2. of Division B of the Building Code.
 - Except for exterior walls (see Note 11), the outer layer of finish on both sides of the wall must have its joints taped and finished.
 - Fastener types and spacing must conform to CSA A82.31-M1980, "Gypsum Board Application".
- (8) Absorptive material required for the higher fire-resistance rating is mineral fibre processed from rock or slag with a mass of at least 4.8 kg/m² for 150 mm thickness, 2.8 kg/m² for 89 mm thickness and 2.0 kg/m² for 65 mm thickness and completely filling the wall cavity. For assemblies with double wood studs on separate plates, absorptive material is required in the stud cavities on both sides.
- (9) Regular gypsum board used in single layer assemblies must be installed so all edges are supported.
- (10) Where bracing material, such as diagonal lumber or plywood, OSB, gypsum board or fibreboard sheathing is installed on the inner face of one row of studs in double stud assemblies, the STC rating will be reduced by 3 for any assemblies containing absorptive material in both rows of studs or in the row of studs opposite to that which the bracing material is attached. Attaching such layers on both inner faces of the studs may drastically reduce the STC value but enough data to permit assignment of STC ratings for this situation is not available. The fire-resistance rating is not affected by the inclusion of such bracing.
- (11) For exterior walls, the finish joints must be taped and finished for the outer layer of the interior side only. The gypsum board on the exterior side may be replaced with gypsum sheathing of the same thickness and type (regular or Type X).
- (12) Includes any exterior wall sheathing and cladding combination allowed under Part 9 other than foamed plastic sheathing. The cladding portion can include foamed plastic outboard of noncombustible, structural wood-based or gypsum-based sheathing conforming to the minimum thicknesses listed in Table 9.23.16.2.A. of Division B of the Building Code.
- (13) Includes any exterior wall sheathing listed in Table 9.23.16.2.A. of Division B of the Building Code and masonry veneer cladding conforming to Section 9.20. of Division B of the Building Code. Foamed plastic sheathing is permitted in EW1d and EW2b walls without the use of other sheathing, provided it is directly attached to the framing.
- (14) The glass fibre insulation filling the cavity shall have a mass per unit area of not less than 1.0 kg/m² of wall surface.

Section 2 Fire and Sound Resistance of Floors, Ceilings and Roofs

Table 2
Fire and Sound Resistance of Floors, Ceilings and Roofs⁽¹⁾

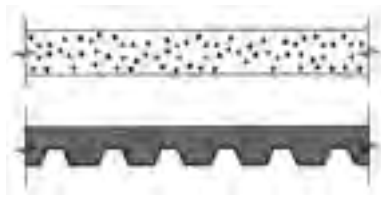

Type of Assembly	Assembly Number	Description ⁽²⁾⁽³⁾⁽⁴⁾	Fire-Resistance Rating ⁽⁵⁾⁽⁶⁾⁽⁷⁾⁽⁸⁾	Typical Sound Transmission Class ⁽⁵⁾⁽⁶⁾⁽⁹⁾⁽¹⁰⁾ (STC)	Typical Impact Insulation Class ⁽⁵⁾⁽⁹⁾⁽¹¹⁾ (IIC)
Floors and Ceilings					
Concrete Slabs	F1	<ul style="list-style-type: none"> concrete floors 			
	F1a	<ul style="list-style-type: none"> 90 mm reinforced concrete with 20 mm minimum cover over reinforcing steel 	1 h	47	23
	F1b	<ul style="list-style-type: none"> 130 mm reinforced concrete with 25 mm minimum cover over reinforcing steel 	2 h	52	27
	F1c	<ul style="list-style-type: none"> pre-stressed hollow core slab 200 mm deep with 25 mm minimum cover over reinforcing steel 	1 h	50	28
	F1d	<ul style="list-style-type: none"> 150 mm composite slab on 75 mm steel deck with 152 x 152 x MW3.8 x MW3.8 wire mesh 	—	51	21
	F1e	<ul style="list-style-type: none"> 150 mm composite slab on 75 mm steel deck with 152 x 152 x MW3.8 x MW3.8 wire mesh resilient metal channels spaced 406 mm or 610 mm o.c. 2 layers of 12.7 mm Type X gypsum board or 2 layers of 15.9 mm Type X gypsum board 	1.5 h	57	36
Open Web Steel Joists	F2	<ul style="list-style-type: none"> open web steel joists with concrete floor 			
	F2a	<ul style="list-style-type: none"> 50 mm thick concrete deck on open web steel joists spaced 406 mm o.c. steel furring channels spaced not more than 610 mm o.c. wired to underside of joists 1 layer of 15.9 mm Type X gypsum board on ceiling side 	45 min	53	27
Column 1	2	3	4	5	6

Table 2 (Cont'd)
Fire and Sound Resistance of Floors, Ceilings and Roofs⁽¹⁾

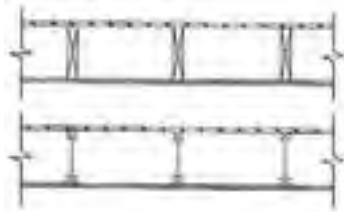
Type of Assembly	Assembly Number	Description ⁽²⁾⁽³⁾⁽⁴⁾	Fire-Resistance Rating ⁽⁵⁾⁽⁶⁾⁽⁷⁾⁽⁸⁾	Typical Sound Transmission Class ⁽⁵⁾⁽⁶⁾⁽⁹⁾⁽¹⁰⁾ (STC)	Typical Impact Insulation Class ⁽⁵⁾⁽⁹⁾⁽¹¹⁾ (IIC)
Floors and Ceilings					
Open Web Steel Joists	F2b	<ul style="list-style-type: none"> • 65 mm regular concrete minimum 155 kg/m² • on composite steel joists spaced 1250 mm o.c. • steel furring channels spaced not more than 610 mm o.c. wired to underside of joists • 1 layer of 12.7 mm Type X gypsum board or 15.9 mm Type X gypsum board on ceiling side 	1.5 h	53	28
Wood Floor Joists ⁽¹²⁾	F3 ⁽¹³⁾	<ul style="list-style-type: none"> • subfloor of 15.5 mm plywood, OSB or waferboard, or 17 mm tongue and groove lumber • on wood joists or wood I-joists spaced not more than 610 mm o.c. • with or without absorptive material in cavity • 1 layer of gypsum board on ceiling side 			
	F3a	F3 with <ul style="list-style-type: none"> • no absorptive material in cavity • 15.9 mm Type X gypsum board 	—	29	27
	F3b	F3 with <ul style="list-style-type: none"> • absorptive material in cavity • 15.9 mm Type X gypsum board 	—	31	30
	F3c	F3 with <ul style="list-style-type: none"> • no absorptive material in cavity • 12.7 mm Type X gypsum board 	—	27	26
	F3d	F3 with <ul style="list-style-type: none"> • absorptive material in cavity • 12.7 mm Type X gypsum board 	—	29	29
	F3e	F3 with <ul style="list-style-type: none"> • no absorptive material in cavity • 12.7 mm regular gypsum board 	—	27	25
	F3f	F3 with <ul style="list-style-type: none"> • absorptive material in cavity • 12.7 mm regular gypsum board 	—	29	28
Column 1	2	3	4	5	6

Table 2 (Cont'd)
Fire and Sound Resistance of Floors, Ceilings and Roofs⁽¹⁾

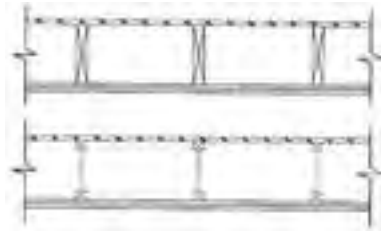
Type of Assembly	Assembly Number	Description ⁽²⁾⁽³⁾⁽⁴⁾	Fire-Resistance Rating ⁽⁵⁾⁽⁶⁾⁽⁷⁾⁽⁸⁾	Typical Sound Transmission Class ⁽⁵⁾⁽⁶⁾⁽⁹⁾⁽¹⁰⁾ (STC)	Typical Impact Insulation Class ⁽⁵⁾⁽⁹⁾⁽¹¹⁾ (IIC)
Floors and Ceilings					
Wood Floor Joists ⁽¹²⁾	F4 ⁽¹³⁾	<ul style="list-style-type: none"> • subfloor of 15.5 mm plywood, OSB or waferboard, or 17 mm tongue and groove lumber • on wood joists or wood I-joists spaced not more than 610 mm o.c. • with or without absorptive material in cavity • 2 layers of gypsum board on ceiling side 			
	F4a	F4 with <ul style="list-style-type: none"> • wood joists or wood I-joists spaced 406 mm o.c. • no absorptive material in cavity • 15.9 mm Type X gypsum board 	1 h	33	31
	F4b	F4 with <ul style="list-style-type: none"> • wood joists or wood I-joists spaced 610 mm o.c. • no absorptive material in cavity • 15.9 mm Type X gypsum board 	1 h	34	31
	F4c	F4 with <ul style="list-style-type: none"> • wood joists or wood I-joists spaced 406 mm o.c. • absorptive material in cavity • 15.9 mm Type X gypsum board 	45 min [1 h] ⁽¹⁴⁾	35	34
	F4d	F4 with <ul style="list-style-type: none"> • wood joists or wood I-joists spaced 610 mm o.c. • absorptive material in cavity • 15.9 mm Type X gypsum board 	45 min	38	34
	F4e	F4 with <ul style="list-style-type: none"> • wood joists or wood I-joists spaced 406 mm o.c. • no absorptive material in cavity • 12.7 mm Type X gypsum board 	1 h	32	30
	F4f	F4 with <ul style="list-style-type: none"> • wood joists or wood I-joists spaced 610 mm o.c. • no absorptive material in cavity • 12.7 mm Type X gypsum board 	45 min	33	30
	F4g	F4 with <ul style="list-style-type: none"> • wood joists or wood I-joists spaced 406 mm o.c. • absorptive material in cavity • 12.7 mm Type X gypsum board 	45 min	34	33
	F4h	F4 with <ul style="list-style-type: none"> • wood joists or wood I-joists spaced 610 mm o.c. • absorptive material in cavity • 12.7 mm Type X gypsum board 	—	35	33
Column 1	2	3	4	5	6

Table 2 (Cont'd)
Fire and Sound Resistance of Floors, Ceilings and Roofs⁽¹⁾

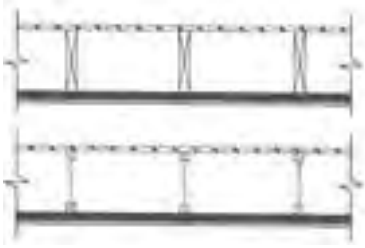
Type of Assembly	Assembly Number	Description ⁽²⁾⁽³⁾⁽⁴⁾	Fire-Resistance Rating ⁽⁵⁾⁽⁶⁾⁽⁷⁾⁽⁸⁾	Typical Sound Transmission Class ⁽⁵⁾⁽⁶⁾⁽⁹⁾⁽¹⁰⁾ (STC)	Typical Impact Insulation Class ⁽⁵⁾⁽⁹⁾⁽¹¹⁾ (IIC)
Floors and Ceilings					
Wood Floor Joists ⁽¹²⁾	F4i	F4 with <ul style="list-style-type: none"> no absorptive material in cavity 12.7 mm regular gypsum board 	—	31	30
	F4j	F4 with <ul style="list-style-type: none"> absorptive material in cavity 12.7 mm regular gypsum board 	—	33	33
	F5 ⁽¹³⁾	<ul style="list-style-type: none"> subfloor of 15.5 mm plywood, OSB or waferboard, or 17 mm tongue and groove lumber on wood joists or wood I-joists spaced not more than 610 mm o.c. with or without absorptive material in cavity steel furring channels spaced 406 mm or 610 mm o.c. 1 layer of gypsum board on ceiling side 			
	F5a	F5 with <ul style="list-style-type: none"> no absorptive material in cavity steel furring channels spaced 406 mm o.c. 15.9 mm Type X gypsum board 	30 min	35	37
	F5b	F5 with <ul style="list-style-type: none"> no absorptive material in cavity steel furring channels spaced 610 mm o.c. 15.9 mm Type X gypsum board 	30 min	37	30
	F5c	F5 with <ul style="list-style-type: none"> absorptive material in cavity steel furring channels spaced 406 mm o.c. 15.9 mm Type X gypsum board 	30 min [45 min] ⁽¹⁵⁾	38	30
	F5d	F5 with <ul style="list-style-type: none"> absorptive material in cavity steel furring channels spaced 610 mm o.c. 15.9 mm Type X gypsum board 	30 min	40	33
	F5e	F5 with <ul style="list-style-type: none"> no absorptive material in cavity steel furring channels spaced 406 mm o.c. 12.7 mm Type X gypsum board 	30 min	33	26
	F5f	F5 with <ul style="list-style-type: none"> no absorptive material in cavity steel furring channels spaced 610 mm o.c. 12.7 mm Type X gypsum board 	30 min	35	29
	Column 1	2	3	4	5

Table 2 (Cont'd)
Fire and Sound Resistance of Floors, Ceilings and Roofs⁽¹⁾

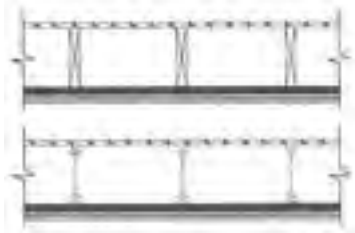
Type of Assembly	Assembly Number	Description ⁽²⁾⁽³⁾⁽⁴⁾	Fire-Resistance Rating ⁽⁵⁾⁽⁶⁾⁽⁷⁾⁽⁸⁾	Typical Sound Transmission Class ⁽⁵⁾⁽⁶⁾⁽⁹⁾⁽¹⁰⁾ (STC)	Typical Impact Insulation Class ⁽⁵⁾⁽⁹⁾⁽¹¹⁾ (IIC)
Floors and Ceilings					
Wood Floor Joists ⁽¹²⁾	F5g	F5 with <ul style="list-style-type: none"> • absorptive material in cavity • steel furring channels spaced 406 mm o.c. • 12.7 mm Type X gypsum board 	30 min [45 min] ⁽¹⁵⁾	36	29
	F5h	F5 with <ul style="list-style-type: none"> • absorptive material in cavity • steel furring channels spaced 610 mm o.c. • 12.7 mm Type X gypsum board 	30 min	38	32
	F5i	F5 with <ul style="list-style-type: none"> • no absorptive material in cavity • steel furring channels spaced 406 mm o.c. • 12.7 mm regular gypsum board 	< 30 min	33	25
	F5j	F5 with <ul style="list-style-type: none"> • no absorptive material in cavity • steel furring channels spaced 610 mm o.c. • 12.7 mm regular gypsum board 	< 30 min	35	28
	F5k	F5 with <ul style="list-style-type: none"> • absorptive material in cavity • steel furring channels spaced 406 mm o.c. • 12.7 mm regular gypsum board 	< 30 min	36	28
	F5l	F5 with <ul style="list-style-type: none"> • absorptive material in cavity • steel furring channels spaced 610 mm o.c. • 12.7 mm regular gypsum board 	< 30 min	38	33
	F6 ⁽¹³⁾	<ul style="list-style-type: none"> • subfloor of 15.5 mm plywood, OSB or waferboard, or 17 mm tongue and groove lumber • on wood joists or wood I-joists spaced not more than 610 mm o.c. • with or without absorptive material in cavity • steel furring channels spaced 406 mm or 610 mm o.c. • 2 layers of gypsum board on ceiling side 			
	F6a ⁽¹⁶⁾	F6 with <ul style="list-style-type: none"> • no absorptive material in cavity • steel furring channels spaced 406 mm o.c. • 15.9 mm Type X gypsum board 	1 h	39	32
	F6b ⁽¹⁶⁾	F6 with <ul style="list-style-type: none"> • no absorptive material in cavity • steel furring channels spaced 610 mm o.c. • 15.9 mm Type X gypsum board 	1 h	41	32
	Column 1	2	3	4	5

Table 2 (Cont'd)
Fire and Sound Resistance of Floors, Ceilings and Roofs⁽¹⁾

Type of Assembly	Assembly Number	Description ⁽²⁾⁽³⁾⁽⁴⁾	Fire-Resistance Rating ⁽⁵⁾⁽⁶⁾⁽⁷⁾⁽⁸⁾	Typical Sound Transmission Class ⁽⁵⁾⁽⁶⁾⁽⁹⁾⁽¹⁰⁾ (STC)	Typical Impact Insulation Class ⁽⁵⁾⁽⁹⁾⁽¹¹⁾ (IIC)
Floors and Ceilings					
Wood Floor Joists ⁽¹²⁾	F6c ⁽¹⁶⁾	F6 with <ul style="list-style-type: none"> • absorptive material in cavity • steel furring channels spaced 406 mm o.c. • 15.9 mm Type X gypsum board 	1 h	42	35
	F6d ⁽¹⁶⁾	F6 with <ul style="list-style-type: none"> • absorptive material in cavity • steel furring channels spaced 610 mm o.c. • 15.9 mm Type X gypsum board 	1 h	44	37
	F6e ⁽¹⁶⁾	F6 with <ul style="list-style-type: none"> • no absorptive material in cavity • steel furring channels spaced 406 mm o.c. • 12.7 mm Type X gypsum board 	1 h	38	30
	F6f ⁽¹⁶⁾	F6 with <ul style="list-style-type: none"> • no absorptive material in cavity • steel furring channels spaced 610 mm o.c. • 12.7 mm Type X gypsum board 	1 h	40	33
	F6g ⁽¹⁶⁾	F6 with <ul style="list-style-type: none"> • absorptive material in cavity • steel furring channels spaced 406 mm o.c. • 12.7 mm Type X gypsum board 	1 h	41	33
	F6h ⁽¹⁶⁾	F6 with <ul style="list-style-type: none"> • absorptive material in cavity • steel furring channels spaced 610 mm o.c. • 12.7 mm Type X gypsum board 	45 min [1 h] ⁽¹⁷⁾	43	36
	F6i	F6 with <ul style="list-style-type: none"> • no absorptive material in cavity • steel furring channels spaced 406 mm o.c. • 12.7 mm regular gypsum board 	—	37	30
	F6j	F6 with <ul style="list-style-type: none"> • no absorptive material in cavity • steel furring channels spaced 610 mm o.c. • 12.7 mm regular gypsum board 	—	39	33
	F6k	F6 with <ul style="list-style-type: none"> • absorptive material in cavity • steel furring channels spaced 406 mm o.c. • 12.7 mm regular gypsum board 	—	40	33
	F6l	F6 with <ul style="list-style-type: none"> • absorptive material in cavity • steel furring channels spaced 610 mm o.c. • 12.7 mm regular gypsum board 	—	42	36
Column 1	2	3	4	5	6

Table 2 (Cont'd)
Fire and Sound Resistance of Floors, Ceilings and Roofs⁽¹⁾

Type of Assembly	Assembly Number	Description ⁽²⁾⁽³⁾⁽⁴⁾	Fire-Resistance Rating ⁽⁵⁾⁽⁶⁾⁽⁷⁾⁽⁸⁾	Typical Sound Transmission Class ⁽⁵⁾⁽⁶⁾⁽⁹⁾⁽¹⁰⁾ (STC)	Typical Impact Insulation Class ⁽⁵⁾⁽⁹⁾⁽¹¹⁾ (IIC)
Floors and Ceilings					
Wood Floor Joists ⁽¹²⁾	F7 ⁽¹³⁾	<ul style="list-style-type: none"> • subfloor of 15.5 mm plywood, OSB or waferboard, or 17 mm tongue and groove lumber • on wood joists or wood I-joists spaced not more than 610 mm o.c. • with or without absorptive material in cavity • 1 layer of gypsum board attached directly to joists on ceiling side • resilient metal channels spaced 406 mm or 610 mm o.c. attached to joists through gypsum board • 1 layer of gypsum board attached to resilient channels 			
	F7a ⁽¹⁶⁾	F7 with <ul style="list-style-type: none"> • no absorptive material in cavity • 15.9 mm Type X gypsum board • resilient metal channels • 15.9 mm Type X gypsum board 	1 h	35	27
	F7b ⁽¹⁶⁾	F7 with <ul style="list-style-type: none"> • absorptive material in cavity • 15.9 mm Type X gypsum board • resilient metal channels • 15.9 mm Type X gypsum board 	1 h	37	30
	F7c ⁽¹⁶⁾	F7 with <ul style="list-style-type: none"> • no absorptive material in cavity • 12.7 mm Type X gypsum board • resilient metal channels • 12.7 mm Type X gypsum board 	1 h	35	27
	F7d ⁽¹⁶⁾	F7 with <ul style="list-style-type: none"> • absorptive material in cavity • 12.7 mm Type X gypsum board • resilient metal channels • 12.7 mm Type X gypsum board 	1 h	37	30
	F7e	F7 with <ul style="list-style-type: none"> • no absorptive material in cavity • 12.7 mm regular gypsum board • resilient metal channels • 12.7 mm regular gypsum board 	—	32	26
	F7f	F7 with <ul style="list-style-type: none"> • absorptive material in cavity • 12.7 mm regular gypsum board • resilient metal channels • 12.7 mm regular gypsum board 	—	35	28
Column 1	2	3	4	5	6

Table 2 (Cont'd)
Fire and Sound Resistance of Floors, Ceilings and Roofs⁽¹⁾

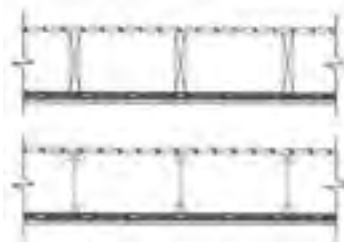
Type of Assembly	Assembly Number	Description ⁽²⁾⁽³⁾⁽⁴⁾	Fire-Resistance Rating ⁽⁵⁾⁽⁶⁾⁽⁷⁾⁽⁸⁾	Typical Sound Transmission Class ⁽⁵⁾⁽⁶⁾⁽⁹⁾⁽¹⁰⁾ (STC)	Typical Impact Insulation Class ⁽⁵⁾⁽⁹⁾⁽¹¹⁾ (IIC)
Floors and Ceilings					
Wood Floor Joists ⁽¹²⁾	F8 ⁽¹³⁾	<ul style="list-style-type: none"> • subfloor of 15.5 mm plywood, OSB or waferboard, or 17 mm tongue and groove lumber • on wood joists or wood I-joists spaced not more than 610 mm o.c. • with or without absorptive material in cavity • resilient metal channels spaced 406 mm or 610 mm o.c. • 1 layer of gypsum board on ceiling side 			
	F8a	F8 with <ul style="list-style-type: none"> • no absorptive material in cavity • resilient metal channels spaced 406 mm o.c. • 15.9 mm Type X gypsum board 	30 min	41	33
	F8b	F8 with <ul style="list-style-type: none"> • no absorptive material in cavity • resilient metal channels spaced 610 mm o.c. • 15.9 mm Type X gypsum board 	30 min	43	36
	F8c	F8 with <ul style="list-style-type: none"> • absorptive material in cavity • resilient metal channels spaced 406 mm o.c. • 15.9 mm Type X gypsum board 	30 min [45 min] ⁽¹⁵⁾	48	41
	F8d	F8 with <ul style="list-style-type: none"> • absorptive material in cavity • resilient metal channels spaced 610 mm o.c. • 15.9 mm Type X gypsum board 	30 min	50	44
	F8e	F8 with <ul style="list-style-type: none"> • no absorptive material in cavity • resilient metal channels spaced 406 mm o.c. • 12.7 mm Type X gypsum board 	30 min	39	32
	F8f	F8 with <ul style="list-style-type: none"> • no absorptive material in cavity • resilient metal channels spaced 610 mm o.c. • 12.7 mm Type X gypsum board 	30 min	41	35
	F8g	F8 with <ul style="list-style-type: none"> • absorptive material in cavity • resilient metal channels spaced 406 mm o.c. • 12.7 mm Type X gypsum board 	30 min [45 min] ⁽¹⁵⁾	46	40
Column 1	2	3	4	5	6

Table 2 (Cont'd)
Fire and Sound Resistance of Floors, Ceilings and Roofs⁽¹⁾

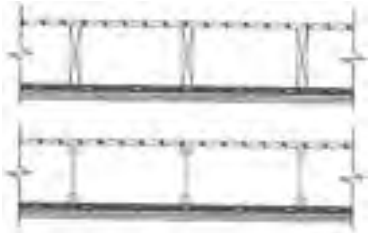
Type of Assembly	Assembly Number	Description ⁽²⁾⁽³⁾⁽⁴⁾	Fire-Resistance Rating ⁽⁵⁾⁽⁶⁾⁽⁷⁾⁽⁸⁾	Typical Sound Transmission Class ⁽⁵⁾⁽⁶⁾⁽⁹⁾⁽¹⁰⁾ (STC)	Typical Impact Insulation Class ⁽⁵⁾⁽⁹⁾⁽¹¹⁾ (IIC)
Floors and Ceilings					
Wood Floor Joists ⁽¹²⁾	F8h	F8 with <ul style="list-style-type: none"> • absorptive material in cavity • resilient metal channels spaced 610 mm o.c. • 12.7 mm Type X gypsum board 	30 min	48	43
	F8i	F8 with <ul style="list-style-type: none"> • no absorptive material in cavity • resilient metal channels spaced 406 mm o.c. • 12.7 mm regular gypsum board 	< 30 min	41	31
	F8j	F8 with <ul style="list-style-type: none"> • no absorptive material in cavity • resilient metal channels spaced 610 mm o.c. • 12.7 mm regular gypsum board 	< 30 min	41	34
	F8k	F8 with <ul style="list-style-type: none"> • absorptive material in cavity • resilient metal channels spaced 406 mm o.c. • 12.7 mm regular gypsum board 	< 30 min	46	39
	F8l	F8 with <ul style="list-style-type: none"> • absorptive material in cavity • resilient metal channels spaced 610 mm o.c. • 12.7 mm regular gypsum board 	< 30 min	48	42
	F9 ⁽¹³⁾	<ul style="list-style-type: none"> • subfloor of 15.5 mm plywood, OSB or waferboard, or 17 mm tongue and groove lumber • on wood joists or wood I-joists spaced not more than 610 mm o.c. • with or without absorptive material in cavity • resilient metal channels spaced 406 mm or 610 mm o.c. • 2 layers of gypsum board on ceiling side 			
	F9a ⁽¹⁶⁾	F9 with <ul style="list-style-type: none"> • no absorptive material in cavity • resilient metal channels spaced 406 mm o.c. • 15.9 mm Type X gypsum board 	1 h	45	38
	F9b ⁽¹⁶⁾	F9 with <ul style="list-style-type: none"> • no absorptive material in cavity • resilient metal channels spaced 610 mm o.c. • 15.9 mm Type X gypsum board 	1 h	47	40
Column 1	2	3	4	5	6

Table 2 (Cont'd)
Fire and Sound Resistance of Floors, Ceilings and Roofs⁽¹⁾

Type of Assembly	Assembly Number	Description ⁽²⁾⁽³⁾⁽⁴⁾	Fire-Resistance Rating ⁽⁵⁾⁽⁶⁾⁽⁷⁾⁽⁸⁾	Typical Sound Transmission Class ⁽⁵⁾⁽⁶⁾⁽⁹⁾⁽¹⁰⁾ (STC)	Typical Impact Insulation Class ⁽⁵⁾⁽⁹⁾⁽¹¹⁾ (IIC)
Floors and Ceilings					
Wood Floor Joists ⁽¹²⁾	F9c ⁽¹⁶⁾	F9 with <ul style="list-style-type: none"> • absorptive material in cavity • resilient metal channels spaced 406 mm o.c. • 15.9 mm Type X gypsum board 	1 h [1.5 h] ⁽¹⁸⁾	52 [54] ⁽¹⁸⁾	46
	F9d ⁽¹⁶⁾	F9 with <ul style="list-style-type: none"> • absorptive material in cavity • resilient metal channels spaced 610 mm o.c. • 15.9 mm Type X gypsum board 	1 h [1.5 h] ⁽¹⁸⁾	54 [56] ⁽¹⁸⁾	48
	F9e ⁽¹⁶⁾	F9 with <ul style="list-style-type: none"> • no absorptive material in cavity • resilient metal channels spaced 406 mm o.c. • 12.7 mm Type X gypsum board 	1 h	44	36
	F9f ⁽¹⁶⁾	F9 with <ul style="list-style-type: none"> • no absorptive material in cavity • resilient metal channels spaced 610 mm o.c. • 12.7 mm Type X gypsum board 	1 h	46	39
	F9g ⁽¹⁶⁾	F9 with <ul style="list-style-type: none"> • absorptive material in cavity • resilient metal channels spaced 406 mm o.c. • 12.7 mm Type X gypsum board 	1 h [1.5 h] ⁽¹⁸⁾	51 [53] ⁽¹⁸⁾	44
	F9h ⁽¹⁶⁾	F9 with <ul style="list-style-type: none"> • absorptive material in cavity • resilient metal channels spaced 610 mm o.c. • 12.7 mm Type X gypsum board 	45 min [1 h] ⁽¹⁷⁾	53	47
	F9i	F9 with <ul style="list-style-type: none"> • no absorptive material in cavity • resilient metal channels spaced 406 mm o.c. • 12.7 mm regular gypsum board 	—	43	36
	F9j	F9 with <ul style="list-style-type: none"> • no absorptive material in cavity • resilient metal channels spaced 610 mm o.c. • 12.7 mm regular gypsum board 	—	45	39
	F9k	F9 with <ul style="list-style-type: none"> • absorptive material in cavity • resilient metal channels spaced 406 mm o.c. • 12.7 mm regular gypsum board 	—	50	44
	F9l	F9 with <ul style="list-style-type: none"> • absorptive material in cavity • resilient metal channels spaced 610 mm o.c. • 12.7 mm regular gypsum board 	—	52	47
Column 1	2	3	4	5	6

Table 2 (Cont'd)
Fire and Sound Resistance of Floors, Ceilings and Roofs⁽¹⁾

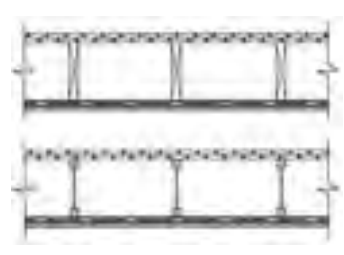
Type of Assembly	Assembly Number	Description ⁽²⁾⁽³⁾⁽⁴⁾	Fire-Resistance Rating ⁽⁵⁾⁽⁶⁾⁽⁷⁾⁽⁸⁾	Typical Sound Transmission Class ⁽⁵⁾⁽⁶⁾⁽⁹⁾⁽¹⁰⁾ (STC)	Typical Impact Insulation Class ⁽⁵⁾⁽⁹⁾⁽¹¹⁾ (IIC)
Floors and Ceilings					
Wood Floor Joists ⁽¹²⁾	F10 ⁽¹³⁾	<ul style="list-style-type: none"> one subfloor layer of 11 mm sanded plywood, or OSB or waferboard one subfloor layer of 15.5 mm plywood, OSB or waferboard, or 17 mm tongue and groove lumber on wood joists or wood I-joists spaced not more than 610 mm o.c. with or without absorptive material in cavity resilient metal channels spaced 305 mm, 406 mm or 610 mm o.c. 1 layer of gypsum board on ceiling side 			
	F10a	F10 with <ul style="list-style-type: none"> no absorptive material in cavity resilient metal channels spaced 406 mm o.c. 15.9 mm Type X gypsum board 	30 min	44	34
	F10b	F10 with <ul style="list-style-type: none"> no absorptive material in cavity resilient metal channels spaced 610 mm o.c. 15.9 mm Type X gypsum board 	30 min	46	37
	F10c	F10 with <ul style="list-style-type: none"> absorptive material in cavity resilient metal channels spaced 406 mm o.c. 15.9 mm Type X gypsum board 	30 min [45 min] ⁽¹⁷⁾	51	42
	F10d	F10 with <ul style="list-style-type: none"> absorptive material in cavity resilient metal channels spaced 610 mm o.c. 15.9 mm Type X gypsum board 	30 min [45 min] ⁽¹⁵⁾	53	45
	F10e	F10 with <ul style="list-style-type: none"> wood joists spaced 406 mm o.c. absorptive material in cavity resilient metal channels spaced 406 mm o.c. 15.9 mm Type X gypsum board 	1 h ⁽¹⁹⁾	53 ⁽¹⁹⁾	44
	F10f ⁽²⁰⁾	F10 with <ul style="list-style-type: none"> wood I-joists spaced 406 mm o.c. absorptive material in cavity resilient metal channels spaced 305 mm o.c. 15.9 mm Type X gypsum board 	1 h ⁽¹⁹⁾	52 ⁽¹⁹⁾	43
	F10g	F10 with <ul style="list-style-type: none"> no absorptive material in cavity resilient metal channels spaced 406 mm o.c. 12.7 mm Type X gypsum board 	30 min	42	33
Column 1	2	3	4	5	6

Table 2 (Cont'd)
Fire and Sound Resistance of Floors, Ceilings and Roofs⁽¹⁾

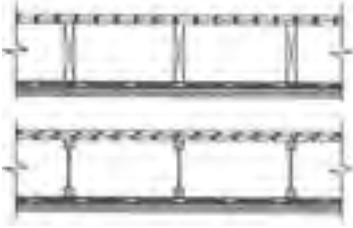
Type of Assembly	Assembly Number	Description ⁽²⁾⁽³⁾⁽⁴⁾	Fire-Resistance Rating ⁽⁵⁾⁽⁶⁾⁽⁷⁾⁽⁸⁾	Typical Sound Transmission Class ⁽⁵⁾⁽⁶⁾⁽⁹⁾⁽¹⁰⁾ (STC)	Typical Impact Insulation Class ⁽⁵⁾⁽⁹⁾⁽¹¹⁾ (IIC)
Floors and Ceilings					
Wood Floor Joists ⁽¹²⁾	F10h	F10 with <ul style="list-style-type: none"> • no absorptive material in cavity • resilient metal channels spaced 610 mm o.c. • 12.7 mm Type X gypsum board 	30 min	44	36
	F10i	F10 with <ul style="list-style-type: none"> • absorptive material in cavity • resilient metal channels spaced 406 mm o.c. • 12.7 mm Type X gypsum board 	30 min [45 min] ⁽¹⁷⁾	49	41
	F10j	F10 with <ul style="list-style-type: none"> • absorptive material in cavity • resilient metal channels spaced 610 mm o.c. • 12.7 mm Type X gypsum board 	30 min [45 min] ⁽¹⁵⁾	51	44
	F10k	F10 with <ul style="list-style-type: none"> • no absorptive material in cavity • resilient metal channels spaced 406 mm o.c. • 12.7 mm regular gypsum board 	—	42	33
	F10l	F10 with <ul style="list-style-type: none"> • no absorptive material in cavity • resilient metal channels spaced 610 mm o.c. • 12.7 mm regular gypsum board 	—	44	35
	F10m	F10 with <ul style="list-style-type: none"> • absorptive material in cavity • resilient metal channels spaced 406 mm o.c. • 12.7 mm regular gypsum board 	—	49	41
	F10n	F10 with <ul style="list-style-type: none"> • absorptive material in cavity • resilient metal channels spaced 610 mm o.c. • 12.7 mm regular gypsum board 	—	51	43
	F11 ⁽¹³⁾	<ul style="list-style-type: none"> • one subfloor layer of 11 mm sanded plywood, or OSB or waferboard • one subfloor layer of 15.5 mm plywood, OSB or waferboard, or 17 mm tongue and groove lumber • on wood joists or wood I-joists spaced not more than 610 mm o.c. • with or without absorptive material in cavity • resilient metal channels spaced 406 mm or 610 mm o.c. • 2 layers of gypsum board on ceiling side 			
	Column 1	2	3	4	5

Table 2 (Cont'd)
Fire and Sound Resistance of Floors, Ceilings and Roofs⁽¹⁾

Type of Assembly	Assembly Number	Description ⁽²⁾⁽³⁾⁽⁴⁾	Fire-Resistance Rating ⁽⁵⁾⁽⁶⁾⁽⁷⁾⁽⁸⁾	Typical Sound Transmission Class ⁽⁵⁾⁽⁶⁾⁽⁹⁾⁽¹⁰⁾ (STC)	Typical Impact Insulation Class ⁽⁵⁾⁽⁹⁾⁽¹¹⁾ (IIC)
Floors and Ceilings					
Wood Floor Joists ⁽¹²⁾	F11a ⁽¹⁶⁾	F11 with <ul style="list-style-type: none"> • no absorptive material in cavity • resilient metal channels spaced 406 mm o.c. • 15.9 mm Type X gypsum board 	1 h	48	39
	F11b ⁽¹⁶⁾	F11 with <ul style="list-style-type: none"> • no absorptive material in cavity • resilient metal channels spaced 610 mm o.c. • 15.9 mm Type X gypsum board 	1 h	50	42
	F11c ⁽¹⁶⁾	F11 with <ul style="list-style-type: none"> • absorptive material in cavity • resilient metal channels spaced 406 mm o.c. • 15.9 mm Type X gypsum board 	1 h [1.5 h] ⁽¹⁸⁾	55 [56] ⁽¹⁸⁾	47
	F11d ⁽¹⁶⁾	F11 with <ul style="list-style-type: none"> • absorptive material in cavity • resilient metal channels spaced 610 mm o.c. • 15.9 mm Type X gypsum board 	1 h [1.5 h] ⁽¹⁸⁾	57 [58] ⁽¹⁸⁾	50
	F11e ⁽¹⁶⁾	F11 with <ul style="list-style-type: none"> • wood joists spaced 406 mm o.c. • absorptive material in cavity • resilient metal channels spaced 406 mm o.c. • 15.9 mm Type X gypsum board 	1.5 h ⁽²¹⁾	56 ⁽²¹⁾	47
	F11f ⁽²⁰⁾	F11 with <ul style="list-style-type: none"> • wood I-joists spaced 406 mm o.c. • absorptive material in cavity • resilient metal channels spaced 305 mm o.c. • 15.9 mm Type X gypsum board 	1.5 h ⁽²¹⁾	56 ⁽²¹⁾	46
	F11g ⁽¹⁶⁾	F11 with <ul style="list-style-type: none"> • no absorptive material in cavity • resilient metal channels spaced 406 mm o.c. • 12.7 mm Type X gypsum board 	1 h	47	38
	F11h ⁽¹⁶⁾	F11 with <ul style="list-style-type: none"> • no absorptive material in cavity • resilient metal channels spaced 610 mm o.c. • 12.7 mm Type X gypsum board 	1 h	49	40
	F11i ⁽¹⁶⁾	F11 with <ul style="list-style-type: none"> • absorptive material in cavity • resilient metal channels spaced 406 mm o.c. • 12.7 mm Type X gypsum board 	1 h [1.5 h] ⁽¹⁸⁾	54 [55] ⁽¹⁸⁾	46
Column 1	2	3	4	5	6

Table 2 (Cont'd)
Fire and Sound Resistance of Floors, Ceilings and Roofs⁽¹⁾

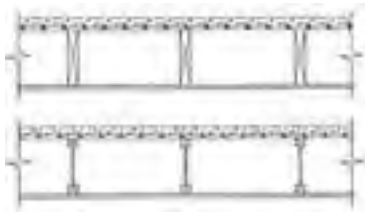
Type of Assembly	Assembly Number	Description ⁽²⁾⁽³⁾⁽⁴⁾	Fire-Resistance Rating ⁽⁵⁾⁽⁶⁾⁽⁷⁾⁽⁸⁾	Typical Sound Transmission Class ⁽⁵⁾⁽⁶⁾⁽⁹⁾⁽¹⁰⁾ (STC)	Typical Impact Insulation Class ⁽⁵⁾⁽⁹⁾⁽¹¹⁾ (IIC)	
Floors and Ceilings						
Wood Floor Joists ⁽¹²⁾	F11j ⁽¹⁶⁾	F11 with <ul style="list-style-type: none"> • absorptive material in cavity • resilient metal channels spaced 610 mm o.c. • 12.7 mm Type X gypsum board 	45 min [1 h] ⁽¹⁷⁾	56	48	
	F11k	F11 with <ul style="list-style-type: none"> • no absorptive material in cavity • resilient metal channels spaced 406 mm o.c. • 12.7 mm regular gypsum board 	—	46	37	
	F11l	F11 with <ul style="list-style-type: none"> • no absorptive material in cavity • resilient metal channels spaced 610 mm o.c. • 12.7 mm regular gypsum board 	—	48	40	
	F11m	F11 with <ul style="list-style-type: none"> • absorptive material in cavity • resilient metal channels spaced 406 mm o.c. • 12.7 mm regular gypsum board 	—	53	45	
	F11n	F11 with <ul style="list-style-type: none"> • absorptive material in cavity • resilient metal channels spaced 610 mm o.c. • 12.7 mm regular gypsum board 	—	55	48	
	F12 ⁽¹³⁾	<ul style="list-style-type: none"> • 25 mm gypsum-concrete topping (at least 44 kg/m²) • subfloor of 15.5 mm plywood, OSB or waferboard, or 17 mm tongue and groove lumber • on wood joists or wood I-joists spaced not more than 610 mm o.c. • with or without absorptive material in cavity • 1 layer of gypsum board on ceiling side 				
	F12a	F12 with <ul style="list-style-type: none"> • no absorptive material in cavity • 15.9 mm Type X gypsum board 	—	41	13	
	F12b	F12 with <ul style="list-style-type: none"> • absorptive material in cavity • 15.9 mm Type X gypsum board 	—	43	16	
	F12c	F12 with <ul style="list-style-type: none"> • no absorptive material in cavity • 12.7 mm Type X gypsum board 	—	39	12	
	F12d	F12 with <ul style="list-style-type: none"> • absorptive material in cavity • 12.7 mm Type X gypsum board 	—	41	15	
	Column 1	2	3	4	5	6

Table 2 (Cont'd)
Fire and Sound Resistance of Floors, Ceilings and Roofs⁽¹⁾

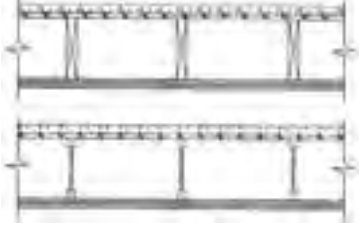
Type of Assembly	Assembly Number	Description ⁽²⁾⁽³⁾⁽⁴⁾	Fire-Resistance Rating ⁽⁵⁾⁽⁶⁾⁽⁷⁾⁽⁸⁾	Typical Sound Transmission Class ⁽⁵⁾⁽⁶⁾⁽⁹⁾⁽¹⁰⁾ (STC)	Typical Impact Insulation Class ⁽⁵⁾⁽⁹⁾⁽¹¹⁾ (IIC)
Floors and Ceilings					
Wood Floor Joists ⁽¹²⁾	F12e	F12 with <ul style="list-style-type: none"> • no absorptive material in cavity • 12.7 mm regular gypsum board 	—	39	12
	F12f	F12 with <ul style="list-style-type: none"> • absorptive material in cavity • 12.7 mm regular gypsum board 	—	41	15
	F13 ⁽¹³⁾	<ul style="list-style-type: none"> • 25 mm gypsum-concrete topping (at least 44 kg/m²) • subfloor of 15.5 mm plywood, OSB or waferboard, or 17 mm tongue and groove lumber • on wood joists or wood I-joists spaced not more than 610 mm o.c. • with or without absorptive material in cavity • 2 layers of gypsum board on ceiling side 			
	F13a	F13 with <ul style="list-style-type: none"> • wood joists or wood I-joists spaced 406 mm o.c. • no absorptive material in cavity • 15.9 mm Type X gypsum board 	1 h	43	16
	F13b	F13 with <ul style="list-style-type: none"> • wood joists or wood I-joists spaced 610 mm o.c. • no absorptive material in cavity • 15.9 mm Type X gypsum board 	1 h	45	16
	F13c	F13 with <ul style="list-style-type: none"> • wood joists or wood I-joists spaced 406 mm o.c. • absorptive material in cavity • 15.9 mm Type X gypsum board 	45 min [1 h] ⁽¹⁴⁾	45	19
	F13d	F13 with <ul style="list-style-type: none"> • wood joists or wood I-joists spaced 610 mm o.c. • absorptive material in cavity • 15.9 mm Type X gypsum board 	45 min	47	19
	F13e	F13 with <ul style="list-style-type: none"> • wood joists or wood I-joists spaced 406 mm o.c. • no absorptive material in cavity • 12.7 mm Type X gypsum board 	1 h	42	15
	Column 1	2	3	4	5

Table 2 (Cont'd)
Fire and Sound Resistance of Floors, Ceilings and Roofs⁽¹⁾

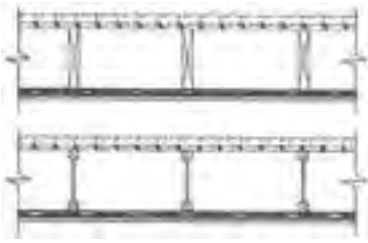
Type of Assembly	Assembly Number	Description ⁽²⁾⁽³⁾⁽⁴⁾	Fire-Resistance Rating ⁽⁵⁾⁽⁶⁾⁽⁷⁾⁽⁸⁾	Typical Sound Transmission Class ⁽⁵⁾⁽⁶⁾⁽⁹⁾⁽¹⁰⁾ (STC)	Typical Impact Insulation Class ⁽⁵⁾⁽⁹⁾⁽¹¹⁾ (IIC)
Floors and Ceilings					
Wood Floor Joists ⁽¹²⁾	F13f	F13 with <ul style="list-style-type: none"> • wood joists or wood I-joists spaced 610 mm o.c. • no absorptive material in cavity • 12.7 mm Type X gypsum board 	45 min	44	15
	F13g	F13 with <ul style="list-style-type: none"> • wood joists or wood I-joists spaced 406 mm o.c. • absorptive material in cavity • 12.7 mm Type X gypsum board 	45 min	44	18
	F13h	F13 with <ul style="list-style-type: none"> • wood joists or wood I-joists spaced 610 mm o.c. • absorptive material in cavity • 12.7 mm Type X gypsum board 	—	46	18
	F13i	F13 with <ul style="list-style-type: none"> • no absorptive material in cavity • 12.7 mm regular gypsum board 	—	41	14
	F13j	F13 with <ul style="list-style-type: none"> • absorptive material in cavity • 12.7 mm regular gypsum board 	—	45	14
	F14 ⁽¹³⁾	<ul style="list-style-type: none"> • 25 mm gypsum-concrete topping (at least 44 kg/m²) • subfloor of 15.5 mm plywood, OSB or waferboard, or 17 mm tongue and groove lumber • on wood joists or wood I-joists spaced not more than 610 mm o.c. • with or without absorptive material in cavity • resilient metal channels spaced 305 mm, 406 mm or 610 mm o.c. • 1 layer of gypsum board on ceiling side 			
	F14a	F14 with <ul style="list-style-type: none"> • no absorptive material in cavity • resilient metal channels spaced 406 mm o.c. • 15.9 mm Type X gypsum board 	—	53	22
	F14b	F14 with <ul style="list-style-type: none"> • no absorptive material in cavity • resilient metal channels spaced 610 mm o.c. • 15.9 mm Type X gypsum board 	—	55	22
	F14c	F14 with <ul style="list-style-type: none"> • absorptive material in cavity • resilient metal channels spaced 406 mm o.c. • 15.9 mm Type X gypsum board 	30 min [45 min] ⁽¹⁷⁾	60	30
	Column 1	2	3	4	5

Table 2 (Cont'd)
Fire and Sound Resistance of Floors, Ceilings and Roofs⁽¹⁾

Type of Assembly	Assembly Number	Description ⁽²⁾⁽³⁾⁽⁴⁾	Fire-Resistance Rating ⁽⁵⁾⁽⁶⁾⁽⁷⁾⁽⁸⁾	Typical Sound Transmission Class ⁽⁵⁾⁽⁶⁾⁽⁹⁾⁽¹⁰⁾ (STC)	Typical Impact Insulation Class ⁽⁵⁾⁽⁹⁾⁽¹¹⁾ (IIC)
Floors and Ceilings					
Wood Floor Joists ⁽¹²⁾	F14d	F14 with <ul style="list-style-type: none"> • absorptive material in cavity • resilient metal channels spaced 610 mm o.c. • 15.9 mm Type X gypsum board 	—	62	30
	F14e	F14 with <ul style="list-style-type: none"> • wood joists spaced 406 mm o.c. • absorptive material in cavity • resilient metal channels spaced 406 mm o.c. • 15.9 mm Type X gypsum board 	1 h ⁽¹⁹⁾	60 ⁽¹⁹⁾	31
	F14f ⁽²⁰⁾	F14 with <ul style="list-style-type: none"> • wood I-joists spaced 406 mm o.c. • absorptive material in cavity • resilient metal channels spaced 305 mm o.c. • 15.9 mm Type X gypsum board 	1 h ⁽¹⁹⁾	61 ⁽¹⁹⁾	31
	F14g	F14 with <ul style="list-style-type: none"> • no absorptive material in cavity • resilient metal channels spaced 406 mm o.c. • 12.7 mm Type X gypsum board 	—	51	21
	F14h	F14 with <ul style="list-style-type: none"> • no absorptive material in cavity • resilient metal channels spaced 610 mm o.c. • 12.7 mm Type X gypsum board 	—	53	21
	F14i	F14 with <ul style="list-style-type: none"> • absorptive material in cavity • resilient metal channels spaced 406 mm o.c. • 12.7 mm Type X gypsum board 	—	58	29
	F14j	F14 with <ul style="list-style-type: none"> • absorptive material in cavity • resilient metal channels spaced 610 mm o.c. • 12.7 mm Type X gypsum board 	—	60	29
	F14k	F14 with <ul style="list-style-type: none"> • no absorptive material in cavity • resilient metal channels spaced 406 mm o.c. • 12.7 mm regular gypsum board 	—	51	21
	F14l	F14 with <ul style="list-style-type: none"> • no absorptive material in cavity • resilient metal channels spaced 610 mm o.c. • 12.7 mm regular gypsum board 	—	53	21
Column 1	2	3	4	5	6

Table 2 (Cont'd)
Fire and Sound Resistance of Floors, Ceilings and Roofs⁽¹⁾


Type of Assembly	Assembly Number	Description ⁽²⁾⁽³⁾⁽⁴⁾	Fire-Resistance Rating ⁽⁵⁾⁽⁶⁾⁽⁷⁾⁽⁸⁾	Typical Sound Transmission Class ⁽⁵⁾⁽⁶⁾⁽⁹⁾⁽¹⁰⁾ (STC)	Typical Impact Insulation Class ⁽⁵⁾⁽⁹⁾⁽¹¹⁾ (IIC)
Floors and Ceilings					
Wood Floor Joists ⁽¹²⁾	F14m	F14 with <ul style="list-style-type: none"> • absorptive material in cavity • resilient metal channels spaced 406 mm o.c. • 12.7 mm regular gypsum board 	—	58	29
	F14n	F14 with <ul style="list-style-type: none"> • absorptive material in cavity • resilient metal channels spaced 610 mm o.c. • 12.7 mm regular gypsum board 	—	60	29
	F15 ⁽¹³⁾	<ul style="list-style-type: none"> • 25 mm gypsum-concrete topping (at least 44 kg/m²) • subfloor of 15.5 mm plywood, OSB or waferboard, or 17 mm tongue and groove lumber • on wood joists or wood I-joists spaced not more than 610 mm o.c. • with or without absorptive material in cavity • resilient metal channels spaced 406 mm or 610 mm o.c. • 2 layers of gypsum board on ceiling side 			
	F15a ⁽¹⁶⁾	F15 with <ul style="list-style-type: none"> • no absorptive material in cavity • resilient metal channels spaced 406 mm o.c. • 15.9 mm Type X gypsum board 	1 h ⁽²²⁾	57	25
	F15b ⁽¹⁶⁾	F15 with <ul style="list-style-type: none"> • no absorptive material in cavity • resilient metal channels spaced 610 mm o.c. • 15.9 mm Type X gypsum board 	1 h	59	25
	F15c ⁽¹⁶⁾	F15 with <ul style="list-style-type: none"> • absorptive material in cavity • resilient metal channels spaced 406 mm o.c. • 15.9 mm Type X gypsum board 	1 h [1.5 h] ⁽¹⁸⁾	64 [65] ⁽¹⁸⁾	33
	F15d ⁽¹⁶⁾	F15 with <ul style="list-style-type: none"> • absorptive material in cavity • resilient metal channels spaced 610 mm o.c. • 15.9 mm Type X gypsum board 	1 h [1.5 h] ⁽¹⁸⁾	66 [67] ⁽¹⁸⁾	33
	F15e ⁽¹⁶⁾	F15 with <ul style="list-style-type: none"> • wood joists spaced 406 mm o.c. • absorptive material in cavity • resilient metal channels spaced 406 mm o.c. • 15.9 mm Type X gypsum board 	1.5 h ⁽²¹⁾	65 ⁽²¹⁾	33
Column 1	2	3	4	5	6

Table 2 (Cont'd)
Fire and Sound Resistance of Floors, Ceilings and Roofs⁽¹⁾

Type of Assembly	Assembly Number	Description ⁽²⁾⁽³⁾⁽⁴⁾	Fire-Resistance Rating ⁽⁵⁾⁽⁶⁾⁽⁷⁾⁽⁸⁾	Typical Sound Transmission Class ⁽⁵⁾⁽⁶⁾⁽⁹⁾⁽¹⁰⁾ (STC)	Typical Impact Insulation Class ⁽⁵⁾⁽⁹⁾⁽¹¹⁾ (IIC)
Floors and Ceilings					
Wood Floor Joists ⁽¹²⁾	F15f ⁽²⁰⁾	F15 with <ul style="list-style-type: none"> • wood I-joists spaced 406 mm o.c. • absorptive material in cavity • resilient metal channels spaced 305 mm o.c. • 15.9 mm Type X gypsum board 	1.5 h ⁽²¹⁾	64 ⁽²¹⁾	33
	F15g ⁽¹⁶⁾	F15 with <ul style="list-style-type: none"> • no absorptive material in cavity • resilient metal channels spaced 406 mm o.c. • 12.7 mm Type X gypsum board 	1 h	56	24
	F15h ⁽¹⁶⁾	F15 with <ul style="list-style-type: none"> • no absorptive material in cavity • resilient metal channels spaced 610 mm o.c. • 12.7 mm Type X gypsum board 	1 h	58	24
	F15i ⁽¹⁶⁾	F15 with <ul style="list-style-type: none"> • absorptive material in cavity • resilient metal channels spaced 406 mm o.c. • 12.7 mm Type X gypsum board 	1 h [1.5 h] ⁽¹⁸⁾	63 [64] ⁽¹⁸⁾	32
	F15j ⁽¹⁶⁾	F15 with <ul style="list-style-type: none"> • absorptive material in cavity • resilient metal channels spaced 610 mm o.c. • 12.7 mm Type X gypsum board 	45 min [1 h] ⁽¹⁷⁾	65	32
	F15k	F15 with <ul style="list-style-type: none"> • no absorptive material in cavity • resilient metal channels spaced 406 mm o.c. • 12.7 mm regular gypsum board 	—	55	23
	F15l	F15 with <ul style="list-style-type: none"> • no absorptive material in cavity • resilient metal channels spaced 610 mm o.c. • 12.7 mm regular gypsum board 	—	57	23
	F15m	F15 with <ul style="list-style-type: none"> • absorptive material in cavity • resilient metal channels spaced 406 mm o.c. • 12.7 mm regular gypsum board 	—	62	31
	F15n	F15 with <ul style="list-style-type: none"> • absorptive material in cavity • resilient metal channels spaced 610 mm o.c. • 12.7 mm regular gypsum board 	—	64	31
Column 1	2	3	4	5	6

Table 2 (Cont'd)
Fire and Sound Resistance of Floors, Ceilings and Roofs⁽¹⁾

Type of Assembly	Assembly Number	Description ⁽²⁾⁽³⁾⁽⁴⁾	Fire-Resistance Rating ⁽⁵⁾⁽⁶⁾⁽⁷⁾⁽⁸⁾	Typical Sound Transmission Class ⁽⁵⁾⁽⁶⁾⁽⁹⁾⁽¹⁰⁾ (STC)	Typical Impact Insulation Class ⁽⁵⁾⁽⁹⁾⁽¹¹⁾ (IIC)
Floors and Ceilings					
Wood Floor Joists ⁽¹²⁾	F16 ⁽¹³⁾	<ul style="list-style-type: none"> • 38 mm concrete topping (at least 70 kg/ m²) • subfloor of 15.5 mm plywood, OSB or waferboard, or 17 mm tongue and groove lumber • on wood joists or wood I-joists spaced not more than 610 mm o.c. • with or without absorptive material in cavity • 1 layer of gypsum board on ceiling side 			
	F16a	F16 with <ul style="list-style-type: none"> • no absorptive material in cavity • 15.9 mm Type X gypsum board 	—	44	22
	F16b	F16 with <ul style="list-style-type: none"> • absorptive material in cavity • 15.9 mm Type X gypsum board 	—	46	25
	F16c	F16 with <ul style="list-style-type: none"> • no absorptive material in cavity • 12.7 mm Type X gypsum board 	—	43	21
	F16d	F16 with <ul style="list-style-type: none"> • absorptive material in cavity • 12.7 mm Type X gypsum board 	—	45	24
	F16e	F16 with <ul style="list-style-type: none"> • no absorptive material in cavity • 12.7 mm regular gypsum board 	—	42	21
	F16f	F16 with <ul style="list-style-type: none"> • absorptive material in cavity • 12.7 mm regular gypsum board 	—	44	24
	F17 ⁽¹³⁾	<ul style="list-style-type: none"> • 38 mm concrete topping (at least 70 kg/m²) • subfloor of 15.5 mm plywood, OSB or waferboard, or 17 mm tongue and groove lumber • on wood joists or wood I-joists spaced not more than 610 mm o.c. • with or without absorptive material in cavity • 2 layers of gypsum board on ceiling side 			
	Column 1	2	3	4	5

Table 2 (Cont'd)
Fire and Sound Resistance of Floors, Ceilings and Roofs⁽¹⁾

Type of Assembly	Assembly Number	Description ⁽²⁾⁽³⁾⁽⁴⁾	Fire-Resistance Rating ⁽⁵⁾⁽⁶⁾⁽⁷⁾⁽⁸⁾	Typical Sound Transmission Class ⁽⁵⁾⁽⁶⁾⁽⁹⁾⁽¹⁰⁾ (STC)	Typical Impact Insulation Class ⁽⁵⁾⁽⁹⁾⁽¹¹⁾ (IIC)
Floors and Ceilings					
Wood Floor Joists ⁽¹²⁾	F17a	F17 with <ul style="list-style-type: none"> • wood joists or wood I-joists spaced 406 mm o.c. • no absorptive material in cavity • 15.9 mm Type X gypsum board 	1 h	48	24
	F17b	F17 with <ul style="list-style-type: none"> • wood joists or wood I-joists spaced 610 mm o.c. • no absorptive material in cavity • 15.9 mm Type X gypsum board 	1 h	51	24
	F17c	F17 with <ul style="list-style-type: none"> • wood joists or wood I-joists spaced 406 mm o.c. • absorptive material in cavity • 15.9 mm Type X gypsum board 	45 min [1 h] ⁽¹⁴⁾	48	27
	F17d	F17 with <ul style="list-style-type: none"> • wood joists or wood I-joists spaced 610 mm o.c. • absorptive material in cavity • 15.9 mm Type X gypsum board 	45 min	51	27
	F17e	F17 with <ul style="list-style-type: none"> • wood joists or wood I-joists spaced 406 mm o.c. • no absorptive material in cavity • 12.7 mm Type X gypsum board 	1 h	47	23
	F17f	F17 with <ul style="list-style-type: none"> • wood joists or wood I-joists spaced 610 mm o.c. • no absorptive material in cavity • 12.7 mm Type X gypsum board 	45 min	48	23
	F17g	F17 with <ul style="list-style-type: none"> • wood joists or wood I-joists spaced 406 mm o.c. • absorptive material in cavity • 12.7 mm Type X gypsum board 	45 min	49	26
	F17h	F17 with <ul style="list-style-type: none"> • wood joists or wood I-joists spaced 610 mm o.c. • absorptive material in cavity • 12.7 mm Type X gypsum board 	—	50	26
	F17i	F17 with <ul style="list-style-type: none"> • no absorptive material in cavity • 12.7 mm regular gypsum board 	—	47	23
	F17j	F17 with <ul style="list-style-type: none"> • absorptive material in cavity • 12.7 mm regular gypsum board 	—	49	26
Column 1	2	3	4	5	6

Table 2 (Cont'd)
Fire and Sound Resistance of Floors, Ceilings and Roofs⁽¹⁾

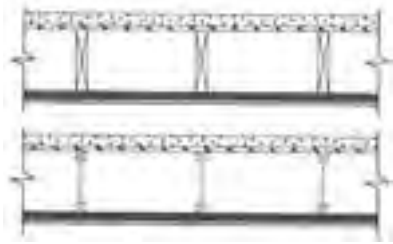
Type of Assembly	Assembly Number	Description ⁽²⁾⁽³⁾⁽⁴⁾	Fire-Resistance Rating ⁽⁵⁾⁽⁶⁾⁽⁷⁾⁽⁸⁾	Typical Sound Transmission Class ⁽⁵⁾⁽⁶⁾⁽⁹⁾⁽¹⁰⁾ (STC)	Typical Impact Insulation Class ⁽⁵⁾⁽⁹⁾⁽¹¹⁾ (IIC)
Floors and Ceilings					
Wood Floor Joists ⁽¹²⁾	F18 ⁽¹³⁾	<ul style="list-style-type: none"> • 38 mm concrete topping (at least 70 kg/m²) • subfloor of 15.5 mm plywood, OSB or waferboard, or 17 mm tongue and groove lumber • on wood joists or wood I-joists spaced not more than 610 mm o.c. • with or without absorptive material in cavity • steel furring channels spaced 406 mm or 610 mm o.c. • 1 layer of gypsum board on ceiling side 			
	F18a	F18 with <ul style="list-style-type: none"> • no absorptive material in cavity • steel furring channels spaced 406 mm o.c. • 15.9 mm Type X gypsum board 	—	50	25
	F18b	F18 with <ul style="list-style-type: none"> • no absorptive material in cavity • steel furring channels spaced 610 mm o.c. • 15.9 mm Type X gypsum board 	—	52	25
	F18c	F18 with <ul style="list-style-type: none"> • absorptive material in cavity • steel furring channels spaced 406 mm o.c. • 15.9 mm Type X gypsum board 	—	53	28
	F18d	F18 with <ul style="list-style-type: none"> • absorptive material in cavity • steel furring channels spaced 610 mm o.c. • 15.9 mm Type X gypsum board 	—	55	28
	F18e	F18 with <ul style="list-style-type: none"> • no absorptive material in cavity • steel furring channels spaced 406 mm o.c. • 12.7 mm Type X gypsum board 	—	49	24
	F18f	F18 with <ul style="list-style-type: none"> • no absorptive material in cavity • steel furring channels spaced 610 mm o.c. • 12.7 mm Type X gypsum board 	—	51	24
	F18g	F18 with <ul style="list-style-type: none"> • absorptive material in cavity • steel furring channels spaced 406 mm o.c. • 12.7 mm Type X gypsum board 	—	52	27
	Column 1	2	3	4	5

Table 2 (Cont'd)
Fire and Sound Resistance of Floors, Ceilings and Roofs⁽¹⁾

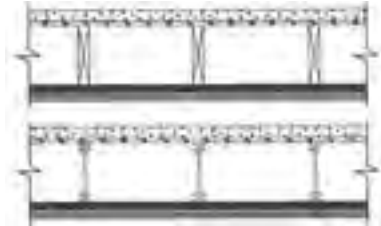
Type of Assembly	Assembly Number	Description ⁽²⁾⁽³⁾⁽⁴⁾	Fire-Resistance Rating ⁽⁵⁾⁽⁶⁾⁽⁷⁾⁽⁸⁾	Typical Sound Transmission Class ⁽⁵⁾⁽⁶⁾⁽⁹⁾⁽¹⁰⁾ (STC)	Typical Impact Insulation Class ⁽⁵⁾⁽⁹⁾⁽¹¹⁾ (IIC)
Floors and Ceilings					
Wood Floor Joists ⁽¹²⁾	F18h	F18 with <ul style="list-style-type: none"> • absorptive material in cavity • steel furring channels spaced 610 mm o.c. • 12.7 mm Type X gypsum board 	—	54	27
	F18i	F18 with <ul style="list-style-type: none"> • no absorptive material in cavity • steel furring channels spaced 406 mm o.c. • 12.7 mm regular gypsum board 	—	48	24
	F18j	F18 with <ul style="list-style-type: none"> • no absorptive material in cavity • steel furring channels spaced 610 mm o.c. • 12.7 mm regular gypsum board 	—	50	24
	F18k	F18 with <ul style="list-style-type: none"> • absorptive material in cavity • steel furring channels spaced 406 mm o.c. • 12.7 mm regular gypsum board 	—	51	27
	F18l	F18 with <ul style="list-style-type: none"> • absorptive material in cavity • steel furring channels spaced 610 mm o.c. • 12.7 mm regular gypsum board 	—	53	27
	F19 ⁽¹³⁾	<ul style="list-style-type: none"> • 38 mm concrete topping (at least 70 kg/m²) • subfloor of 15.5 mm plywood, OSB or waferboard, or 17 mm tongue and groove lumber • on wood joists or wood I-joists spaced not more than 610 mm o.c. • with or without absorptive material in cavity • steel furring channels spaced 406 mm or 610 mm o.c. • 2 layers of gypsum board on ceiling side 			
	F19a ⁽¹⁶⁾	F19 with <ul style="list-style-type: none"> • no absorptive material in cavity • steel furring channels spaced 406 mm o.c. • 15.9 mm Type X gypsum board 	1 h	54	27
	F19b ⁽¹⁶⁾	F19 with <ul style="list-style-type: none"> • no absorptive material in cavity • steel furring channels spaced 610 mm o.c. • 15.9 mm Type X gypsum board 	1 h	56	27
	Column 1	2	3	4	5

Table 2 (Cont'd)
Fire and Sound Resistance of Floors, Ceilings and Roofs⁽¹⁾

Type of Assembly	Assembly Number	Description ⁽²⁾⁽³⁾⁽⁴⁾	Fire-Resistance Rating ⁽⁵⁾⁽⁶⁾⁽⁷⁾⁽⁸⁾	Typical Sound Transmission Class ⁽⁵⁾⁽⁶⁾⁽⁹⁾⁽¹⁰⁾ (STC)	Typical Impact Insulation Class ⁽⁵⁾⁽⁹⁾⁽¹¹⁾ (IIC)
Floors and Ceilings					
Wood Floor Joists ⁽¹²⁾	F19c ⁽¹⁶⁾	F19 with <ul style="list-style-type: none"> • absorptive material in cavity • steel furring channels spaced 406 mm o.c. • 15.9 mm Type X gypsum board 	1 h	57	30
	F19d ⁽¹⁶⁾	F19 with <ul style="list-style-type: none"> • absorptive material in cavity • steel furring channels spaced 610 mm o.c. • 15.9 mm Type X gypsum board 	1 h	59	30
	F19e ⁽¹⁶⁾	F19 with <ul style="list-style-type: none"> • no absorptive material in cavity • steel furring channels spaced 406 mm o.c. • 12.7 mm Type X gypsum board 	1 h	53	26
	F19f ⁽¹⁶⁾	F19 with <ul style="list-style-type: none"> • no absorptive material in cavity • steel furring channels spaced 610 mm o.c. • 12.7 mm Type X gypsum board 	1 h	55	26
	F19g ⁽¹⁶⁾	F19 with <ul style="list-style-type: none"> • absorptive material in cavity • steel furring channels spaced 406 mm o.c. • 12.7 mm Type X gypsum board 	1 h	56	29
	F19h ⁽¹⁶⁾	F19 with <ul style="list-style-type: none"> • absorptive material in cavity • steel furring channels spaced 610 mm o.c. • 12.7 mm Type X gypsum board 	1 h	58	29
	F19i	F19 with <ul style="list-style-type: none"> • no absorptive material in cavity • steel furring channels spaced 406 mm o.c. • 12.7 mm regular gypsum board 	—	53	26
	F19j	F19 with <ul style="list-style-type: none"> • no absorptive material in cavity • steel furring channels spaced 610 mm o.c. • 12.7 mm regular gypsum board 	—	55	26
	F19k	F19 with <ul style="list-style-type: none"> • absorptive material in cavity • steel furring channels spaced 406 mm o.c. • 12.7 mm regular gypsum board 	—	56	29
	F19l	F19 with <ul style="list-style-type: none"> • absorptive material in cavity • steel furring channels spaced 610 mm o.c. • 12.7 mm regular gypsum board 	—	58	29
Column 1	2	3	4	5	6

Table 2 (Cont'd)
Fire and Sound Resistance of Floors, Ceilings and Roofs⁽¹⁾


Type of Assembly	Assembly Number	Description ⁽²⁾⁽³⁾⁽⁴⁾	Fire-Resistance Rating ⁽⁵⁾⁽⁶⁾⁽⁷⁾⁽⁸⁾	Typical Sound Transmission Class ⁽⁵⁾⁽⁶⁾⁽⁹⁾⁽¹⁰⁾ (STC)	Typical Impact Insulation Class ⁽⁵⁾⁽⁹⁾⁽¹¹⁾ (IIC)
Floors and Ceilings					
Wood Floor Joists ⁽¹²⁾	F20 ⁽¹³⁾	<ul style="list-style-type: none"> • 38 mm concrete topping (at least 70 kg/m²) • subfloor of 15.5 mm plywood, OSB or waferboard, or 17 mm tongue and groove lumber • on wood joists or wood I-joists spaced not more than 610 mm o.c. • with or without absorptive material in cavity • resilient metal channels spaced 305 mm, 406 mm or 610 mm o.c. • 1 layer of gypsum board on ceiling side 			
	F20a	F20 with <ul style="list-style-type: none"> • no absorptive material in cavity • resilient metal channels spaced 406 mm o.c. • 15.9 mm Type X gypsum board 	[45 min] ⁽²²⁾	56	31
	F20b	F20 with <ul style="list-style-type: none"> • no absorptive material in cavity • resilient metal channels spaced 610 mm o.c. • 15.9 mm Type X gypsum board 	—	58	31
	F20c	F20 with <ul style="list-style-type: none"> • absorptive material in cavity • resilient metal channels spaced 406 mm o.c. • 15.9 mm Type X gypsum board 	30 min [45 min] ⁽¹⁷⁾⁽²²⁾	63	39
	F20d	F20 with <ul style="list-style-type: none"> • absorptive material in cavity • resilient metal channels spaced 610 mm o.c. • 15.9 mm Type X gypsum board 	—	65	39
	F20e	F20 with <ul style="list-style-type: none"> • wood joists spaced 406 mm o.c. • absorptive material in cavity • resilient metal channels spaced 406 mm o.c. • 15.9 mm Type X gypsum board 	1 h ⁽¹⁹⁾	64 ⁽¹⁹⁾	40
	F20f ⁽²⁰⁾	F20 with <ul style="list-style-type: none"> • wood I-joists spaced 406 mm o.c. • absorptive material in cavity • resilient metal channels spaced 305 mm o.c. • 15.9 mm Type X gypsum board 	1 h ⁽¹⁹⁾	65 ⁽¹⁹⁾	40
	F20g	F20 with <ul style="list-style-type: none"> • no absorptive material in cavity • resilient metal channels spaced 406 mm o.c. • 12.7 mm Type X gypsum board 	—	55	30
Column 1	2	3	4	5	6

Table 2 (Cont'd)
Fire and Sound Resistance of Floors, Ceilings and Roofs⁽¹⁾

Type of Assembly	Assembly Number	Description ⁽²⁾⁽³⁾⁽⁴⁾	Fire-Resistance Rating ⁽⁵⁾⁽⁶⁾⁽⁷⁾⁽⁸⁾	Typical Sound Transmission Class ⁽⁵⁾⁽⁶⁾⁽⁹⁾⁽¹⁰⁾ (STC)	Typical Impact Insulation Class ⁽⁵⁾⁽⁹⁾⁽¹¹⁾ (IIC)
Floors and Ceilings					
Wood Floor Joists ⁽¹²⁾	F20h	F20 with <ul style="list-style-type: none"> • no absorptive material in cavity • resilient metal channels spaced 610 mm o.c. • 12.7 mm Type X gypsum board 	—	57	30
	F20i	F20 with <ul style="list-style-type: none"> • absorptive material in cavity • resilient metal channels spaced 406 mm o.c. • 12.7 mm Type X gypsum board 	—	62	38
	F20j	F20 with <ul style="list-style-type: none"> • absorptive material in cavity • resilient metal channels spaced 610 mm o.c. • 12.7 mm Type X gypsum board 	—	64	38
	F20k	F20 with <ul style="list-style-type: none"> • no absorptive material in cavity • resilient metal channels spaced 406 mm o.c. • 12.7 mm regular gypsum board 	—	54	30
	F20l	F20 with <ul style="list-style-type: none"> • no absorptive material in cavity • resilient metal channels spaced 610 mm o.c. • 12.7 mm regular gypsum board 	—	56	30
	F20m	F20 with <ul style="list-style-type: none"> • absorptive material in cavity • resilient metal channels spaced 406 mm o.c. • 12.7 mm regular gypsum board 	—	61	38
	F20n	F20 with <ul style="list-style-type: none"> • absorptive material in cavity • resilient metal channels spaced 610 mm o.c. • 12.7 mm regular gypsum board 	—	63	38
	F21 ⁽¹³⁾	<ul style="list-style-type: none"> • 38 mm concrete topping (at least 70 kg/m²) • subfloor of 15.5 mm plywood, OSB or waferboard, or 17 mm tongue and groove lumber • on wood joists or wood I-joists spaced not more than 610 mm o.c. • with or without absorptive material in cavity • resilient metal channels spaced 305 mm, 406 mm or 610 mm o.c. • 2 layers of gypsum board on ceiling side 			
Column 1	2	3	4	5	6

Table 2 (Cont'd)
Fire and Sound Resistance of Floors, Ceilings and Roofs⁽¹⁾

Type of Assembly	Assembly Number	Description ⁽²⁾⁽³⁾⁽⁴⁾	Fire-Resistance Rating ⁽⁵⁾⁽⁶⁾⁽⁷⁾⁽⁸⁾	Typical Sound Transmission Class ⁽⁵⁾⁽⁶⁾⁽⁹⁾⁽¹⁰⁾ (STC)	Typical Impact Insulation Class ⁽⁵⁾⁽⁹⁾⁽¹¹⁾ (IIC)
Floors and Ceilings					
Wood Floor Joists ⁽¹²⁾	F21a ⁽¹⁶⁾	F21 with <ul style="list-style-type: none"> • no absorptive material in cavity • resilient metal channels spaced 406 mm o.c. • 15.9 mm Type X gypsum board 	1 h	60	33
	F21b ⁽¹⁶⁾	F21 with <ul style="list-style-type: none"> • no absorptive material in cavity • resilient metal channels spaced 610 mm o.c. • 15.9 mm Type X gypsum board 	1 h	62	33
	F21c ⁽¹⁶⁾	F21 with <ul style="list-style-type: none"> • absorptive material in cavity • resilient metal channels spaced 406 mm o.c. • 15.9 mm Type X gypsum board 	1 h [1.5 h] ⁽¹⁸⁾	67 [68] ⁽¹⁸⁾	41 [42] ⁽¹⁸⁾
	F21d ⁽¹⁶⁾	F21 with <ul style="list-style-type: none"> • absorptive material in cavity • resilient metal channels spaced 610 mm o.c. • 15.9 mm Type X gypsum board 	1 h [1.5 h] ⁽¹⁸⁾	69 [70] ⁽¹⁸⁾	41 [42] ⁽¹⁸⁾
	F21e ⁽¹⁶⁾	F21 with <ul style="list-style-type: none"> • wood joists spaced 406 mm o.c. • absorptive material in cavity • resilient metal channels spaced 406 mm o.c. • 15.9 mm Type X gypsum board 	[1.5 h] ⁽²¹⁾	68 ⁽²¹⁾	42
	F21f ⁽²⁰⁾	F21 with <ul style="list-style-type: none"> • wood I-joists spaced 406 mm o.c. • absorptive material in cavity • resilient metal channels spaced 305 mm o.c. • 15.9 mm Type X gypsum board 	[1.5 h] ⁽²¹⁾	68 ⁽²¹⁾	42
	F21g ⁽¹⁶⁾	F21 with <ul style="list-style-type: none"> • no absorptive material in cavity • resilient metal channels spaced 406 mm o.c. • 12.7 mm Type X gypsum board 	1 h	59	32
	F21h ⁽¹⁶⁾	F21 with <ul style="list-style-type: none"> • no absorptive material in cavity • resilient metal channels spaced 610 mm o.c. • 12.7 mm Type X gypsum board 	1 h	61	32
	F21i ⁽¹⁶⁾	F21 with <ul style="list-style-type: none"> • absorptive material in cavity • resilient metal channels spaced 406 mm o.c. • 12.7 mm Type X gypsum board 	1 h [1.5 h] ⁽¹⁸⁾	66 [67] ⁽¹⁸⁾	40
	Column 1	2	3	4	5

Table 2 (Cont'd)
Fire and Sound Resistance of Floors, Ceilings and Roofs⁽¹⁾


Type of Assembly	Assembly Number	Description ⁽²⁾⁽³⁾⁽⁴⁾	Fire-Resistance Rating ⁽⁵⁾⁽⁶⁾⁽⁷⁾⁽⁸⁾	Typical Sound Transmission Class ⁽⁵⁾⁽⁶⁾⁽⁹⁾⁽¹⁰⁾ (STC)	Typical Impact Insulation Class ⁽⁵⁾⁽⁹⁾⁽¹¹⁾ (IIC)
Floors and Ceilings					
Wood Floor Joists ⁽¹²⁾	F21j ⁽¹⁶⁾	F21 with <ul style="list-style-type: none"> • absorptive material in cavity • resilient metal channels spaced 610 mm o.c. • 12.7 mm Type X gypsum board 	1 h	68	40
	F21k	F21 with <ul style="list-style-type: none"> • no absorptive material in cavity • resilient metal channels spaced 406 mm o.c. • 12.7 mm regular gypsum board 	—	59	32
	F21l	F21 with <ul style="list-style-type: none"> • no absorptive material in cavity • resilient metal channels spaced 610 mm o.c. • 12.7 mm regular gypsum board 	—	61	32
	F21m	F21 with <ul style="list-style-type: none"> • absorptive material in cavity • resilient metal channels spaced 406 mm o.c. • 12.7 mm regular gypsum board 	—	66	40
	F21n	F21 with <ul style="list-style-type: none"> • absorptive material in cavity • resilient metal channels spaced 610 mm o.c. • 12.7 mm regular gypsum board 	—	68	40
Wood Floor Trusses ⁽²³⁾	F22	<ul style="list-style-type: none"> • subfloor of 15.5 mm plywood, OSB or waferboard, or 17 mm tongue and groove lumber • on wood trusses spaced not more than 610 mm o.c. • with or without absorptive material in cavity • 1 layer of gypsum board on ceiling side 			
	F22a	F22 with <ul style="list-style-type: none"> • no absorptive material in cavity • 15.9 mm Type X gypsum board 	—	29	27
	F22b	F22 with <ul style="list-style-type: none"> • absorptive material in cavity • 15.9 mm Type X gypsum board 	—	31	30
	F22c	F22 with <ul style="list-style-type: none"> • no absorptive material in cavity • 12.7 mm Type X gypsum board 	—	28	26
	F22d	F22 with <ul style="list-style-type: none"> • absorptive material in cavity • 12.7 mm Type X gypsum board 	—	30	29
Column 1	2	3	4	5	6

Table 2 (Cont'd)
Fire and Sound Resistance of Floors, Ceilings and Roofs⁽¹⁾


Type of Assembly	Assembly Number	Description ⁽²⁾⁽³⁾⁽⁴⁾	Fire-Resistance Rating ⁽⁵⁾⁽⁶⁾⁽⁷⁾⁽⁸⁾	Typical Sound Transmission Class ⁽⁵⁾⁽⁶⁾⁽⁹⁾⁽¹⁰⁾ (STC)	Typical Impact Insulation Class ⁽⁵⁾⁽⁹⁾⁽¹¹⁾ (IIC)
Floors and Ceilings					
Wood Floor Trusses ⁽²³⁾	F22e	F22 with <ul style="list-style-type: none"> • no absorptive material in cavity • 12.7 mm regular gypsum board 	—	27	25
	F22f	F22 with <ul style="list-style-type: none"> • absorptive material in cavity • 12.7 mm regular gypsum board 	—	31	28
	F23	<ul style="list-style-type: none"> • subfloor of 15.5 mm plywood, OSB or waferboard, or 17 mm tongue and groove lumber • on wood trusses spaced not more than 610 mm o.c. • with or without absorptive material in cavity • 2 layers of gypsum board on ceiling side 			
	F23a	F23 with <ul style="list-style-type: none"> • wood trusses spaced 406 mm o.c. • no absorptive material in cavity • 15.9 mm Type X gypsum board 	1 h	34	31
	F23b	F23 with <ul style="list-style-type: none"> • wood trusses spaced 610 mm o.c. • no absorptive material in cavity • 15.9 mm Type X gypsum board 	1 h	35	31
	F23c	F23 with <ul style="list-style-type: none"> • wood trusses spaced 406 mm o.c. • absorptive material in cavity • 15.9 mm Type X gypsum board 	45 min [1 h] ⁽¹⁴⁾	36	34
	F23d	F23 with <ul style="list-style-type: none"> • wood trusses spaced 610 mm o.c. • absorptive material in cavity • 15.9 mm Type X gypsum board 	45 min	37	34
	F23e	F23 with <ul style="list-style-type: none"> • wood trusses spaced 406 mm o.c. • no absorptive material in cavity • 12.7 mm Type X gypsum board 	1 h	32	30
	F23f	F23 with <ul style="list-style-type: none"> • wood trusses spaced 610 mm o.c. • no absorptive material in cavity • 12.7 mm Type X gypsum board 	45 min	33	30
	F23g	F23 with <ul style="list-style-type: none"> • absorptive material in cavity • 12.7 mm Type X gypsum board 	—	34	33
Column 1	2	3	4	5	6

Table 2 (Cont'd)
Fire and Sound Resistance of Floors, Ceilings and Roofs⁽¹⁾

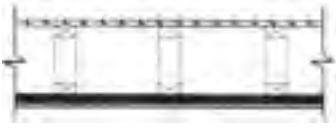
Type of Assembly	Assembly Number	Description ⁽²⁾⁽³⁾⁽⁴⁾	Fire-Resistance Rating ⁽⁵⁾⁽⁶⁾⁽⁷⁾⁽⁸⁾	Typical Sound Transmission Class ⁽⁵⁾⁽⁶⁾⁽⁹⁾⁽¹⁰⁾ (STC)	Typical Impact Insulation Class ⁽⁵⁾⁽⁹⁾⁽¹¹⁾ (IIC)
Floors and Ceilings					
Wood Floor Trusses ⁽²³⁾	F23h	F23 with <ul style="list-style-type: none"> • no absorptive material in cavity • 12.7 mm regular gypsum board 	—	32	30
	F23i	F23 with <ul style="list-style-type: none"> • absorptive material in cavity • 12.7 mm regular gypsum board 	—	34	33
	F24	<ul style="list-style-type: none"> • subfloor of 15.5 mm plywood, OSB or waferboard, or 17 mm tongue and groove lumber • on wood trusses spaced not more than 610 mm o.c. • with or without absorptive material in cavity • steel furring channels spaced 406 mm or 610 mm o.c. • 1 layer of gypsum board on ceiling side 			
	F24a	F24 with <ul style="list-style-type: none"> • no absorptive material in cavity • steel furring channels spaced 406 mm o.c. • 15.9 mm Type X gypsum board 	—	35	27
	F24b	F24 with <ul style="list-style-type: none"> • no absorptive material in cavity • steel furring channels spaced 610 mm o.c. • 15.9 mm Type X gypsum board 	—	37	30
	F24c	F24 with <ul style="list-style-type: none"> • absorptive material in cavity • steel furring channels spaced 406 mm o.c. • 15.9 mm Type X gypsum board 	—	38	30
	F24d	F24 with <ul style="list-style-type: none"> • absorptive material in cavity • steel furring channels spaced 610 mm o.c. • 15.9 mm Type X gypsum board 	—	40	33
	F24e	F24 with <ul style="list-style-type: none"> • no absorptive material in cavity • steel furring channels spaced 406 mm o.c. • 12.7 mm Type X gypsum board 	—	33	26
	F24f	F24 with <ul style="list-style-type: none"> • no absorptive material in cavity • steel furring channels spaced 610 mm o.c. • 12.7 mm Type X gypsum board 	—	36	29
	Column 1	2	3	4	5

Table 2 (Cont'd)
Fire and Sound Resistance of Floors, Ceilings and Roofs⁽¹⁾

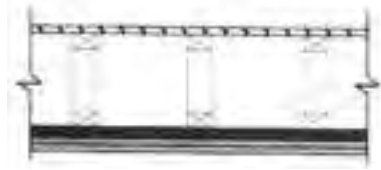
Type of Assembly	Assembly Number	Description ⁽²⁾⁽³⁾⁽⁴⁾	Fire-Resistance Rating ⁽⁵⁾⁽⁶⁾⁽⁷⁾⁽⁸⁾	Typical Sound Transmission Class ⁽⁵⁾⁽⁶⁾⁽⁹⁾⁽¹⁰⁾ (STC)	Typical Impact Insulation Class ⁽⁵⁾⁽⁹⁾⁽¹¹⁾ (IIC)
Floors and Ceilings					
Wood Floor Trusses ⁽²³⁾	F24g	F24 with <ul style="list-style-type: none"> • absorptive material in cavity • steel furring channels spaced 406 mm o.c. • 12.7 mm Type X gypsum board 	—	37	29
	F24h	F24 with <ul style="list-style-type: none"> • absorptive material in cavity • steel furring channels spaced 610 mm o.c. • 12.7 mm Type X gypsum board 	—	39	32
	F24i	F24 with <ul style="list-style-type: none"> • no absorptive material in cavity • steel furring channels spaced 406 mm • 12.7 mm regular gypsum board 	—	33	25
	F24j	F24 with <ul style="list-style-type: none"> • no absorptive material in cavity • steel furring channels spaced 610 mm • 12.7 mm regular gypsum board 	—	35	28
	F24k	F24 with <ul style="list-style-type: none"> • absorptive material in cavity • steel furring channels spaced 406 mm • 12.7 mm regular gypsum board 	—	36	28
	F24l	F24 with <ul style="list-style-type: none"> • absorptive material in cavity • steel furring channels spaced 610 mm • 12.7 mm regular gypsum board 	—	38	31
	F25	<ul style="list-style-type: none"> • subfloor of 15.5 mm plywood, OSB or waferboard, or 17 mm tongue and groove lumber • on wood trusses spaced not more than 610 mm o.c. • with or without absorptive material in cavity • steel furring channels spaced 406 mm or 610 mm o.c. • 2 layers of gypsum board on ceiling side 			
	F25a	F25 with <ul style="list-style-type: none"> • no absorptive material in cavity • steel furring channels spaced 406 mm o.c. • 15.9 mm Type X gypsum board 	1 h	40	32
	F25b	F25 with <ul style="list-style-type: none"> • no absorptive material in cavity • steel furring channels spaced 610 mm o.c. • 15.9 mm Type X gypsum board 	1 h	42	34
	Column 1	2	3	4	5

Table 2 (Cont'd)
Fire and Sound Resistance of Floors, Ceilings and Roofs⁽¹⁾

Type of Assembly	Assembly Number	Description ⁽²⁾⁽³⁾⁽⁴⁾	Fire-Resistance Rating ⁽⁵⁾⁽⁶⁾⁽⁷⁾⁽⁸⁾	Typical Sound Transmission Class ⁽⁵⁾⁽⁶⁾⁽⁹⁾⁽¹⁰⁾ (STC)	Typical Impact Insulation Class ⁽⁵⁾⁽⁹⁾⁽¹¹⁾ (IIC)
Floors and Ceilings					
Wood Floor Trusses ⁽²³⁾	F25c	F25 with <ul style="list-style-type: none"> • absorptive material in cavity • steel furring channels spaced 406 mm o.c. • 15.9 mm Type X gypsum board 	1 h	43	35
	F25d	F25 with <ul style="list-style-type: none"> • absorptive material in cavity • steel furring channels spaced 610 mm o.c. • 15.9 mm Type X gypsum board 	45 min [1 h] ⁽¹⁷⁾	45	37
	F25e	F25 with <ul style="list-style-type: none"> • no absorptive material in cavity • steel furring channels spaced 406 mm o.c. • 12.7 mm Type X gypsum board 	1 h	38	30
	F25f	F25 with <ul style="list-style-type: none"> • no absorptive material in cavity • steel furring channels spaced 610 mm o.c. • 12.7 mm Type X gypsum board 	1 h	40	33
	F25g	F25 with <ul style="list-style-type: none"> • absorptive material in cavity • steel furring channels spaced 406 mm o.c. • 12.7 mm Type X gypsum board 	1 h	41	33
	F25h	F25 with <ul style="list-style-type: none"> • absorptive material in cavity • steel furring channels spaced 610 mm o.c. • 12.7 mm Type X gypsum board 	45 min [1 h] ⁽¹⁷⁾	43	36
	F25i	F25 with <ul style="list-style-type: none"> • no absorptive material in cavity • steel furring channels spaced 406 mm o.c. • 12.7 mm regular gypsum board 	—	38	30
	F25j	F25 with <ul style="list-style-type: none"> • no absorptive material in cavity • steel furring channels spaced 610 mm o.c. • 12.7 mm regular gypsum board 	—	40	33
	F25k	F25 with <ul style="list-style-type: none"> • absorptive material in cavity • steel furring channels spaced 406 mm o.c. • 12.7 mm regular gypsum board 	—	41	33
	F25l	F25 with <ul style="list-style-type: none"> • no absorptive material in cavity • steel furring channels spaced 610 mm o.c. • 12.7 mm regular gypsum board 	—	43	36
Column 1	2	3	4	5	6

Table 2 (Cont'd)
Fire and Sound Resistance of Floors, Ceilings and Roofs⁽¹⁾

Type of Assembly	Assembly Number	Description ⁽²⁾⁽³⁾⁽⁴⁾	Fire-Resistance Rating ⁽⁵⁾⁽⁶⁾⁽⁷⁾⁽⁸⁾	Typical Sound Transmission Class ⁽⁵⁾⁽⁶⁾⁽⁹⁾⁽¹⁰⁾ (STC)	Typical Impact Insulation Class ⁽⁵⁾⁽⁹⁾⁽¹¹⁾ (IIC)
Floors and Ceilings					
Wood Floor Trusses ⁽²³⁾	F26	<ul style="list-style-type: none"> • subfloor of 15.5 mm plywood, OSB or waferboard, or 17 mm tongue and groove lumber • on wood trusses spaced not more than 610 mm o.c. • with or without absorptive material in cavity • 1 layer of gypsum board attached directly to trusses on ceiling side • resilient metal channels spaced 406 mm or 610 mm o.c. attached to trusses through the gypsum board • 1 layer of gypsum board attached to resilient metal channels 			
	F26a	F26 with <ul style="list-style-type: none"> • no absorptive material in cavity • 15.9 mm Type X gypsum board • resilient metal channels • 15.9 mm Type X gypsum board 	—	35	27
	F26b	F26 with <ul style="list-style-type: none"> • absorptive material in cavity • 15.9 mm Type X gypsum board • resilient metal channels • 15.9 mm Type X gypsum board 	—	37	30
	F26c	F26 with <ul style="list-style-type: none"> • no absorptive material in cavity • 12.7 mm Type X gypsum board • resilient metal channels • 12.7 mm Type X gypsum board 	—	35	27
	F26d	F26 with <ul style="list-style-type: none"> • absorptive material in cavity • 12.7 mm Type X gypsum board • resilient metal channels • 12.7 mm Type X gypsum board 	—	37	30
	F26e	F26 with <ul style="list-style-type: none"> • no absorptive material in cavity • 12.7 mm regular gypsum board • resilient metal channels • 12.7 mm regular gypsum board 	—	32	26
	F26f	F26 with <ul style="list-style-type: none"> • absorptive material in cavity • 12.7 mm regular gypsum board • resilient metal channels • 12.7 mm regular gypsum board 	—	35	28
	Column 1	2	3	4	5

Table 2 (Cont'd)
Fire and Sound Resistance of Floors, Ceilings and Roofs⁽¹⁾


Type of Assembly	Assembly Number	Description ⁽²⁾⁽³⁾⁽⁴⁾	Fire-Resistance Rating ⁽⁵⁾⁽⁶⁾⁽⁷⁾⁽⁸⁾	Typical Sound Transmission Class ⁽⁵⁾⁽⁶⁾⁽⁹⁾⁽¹⁰⁾ (STC)	Typical Impact Insulation Class ⁽⁵⁾⁽⁹⁾⁽¹¹⁾ (IIC)
Floors and Ceilings					
Wood Floor Trusses ⁽²³⁾	F27	<ul style="list-style-type: none"> • subfloor of 15.5 mm plywood, OSB or waferboard, or 17 mm tongue and groove lumber • on wood trusses spaced not more than 610 mm o.c. • with or without absorptive material in cavity • resilient metal channels spaced 406 mm or 610 mm o.c. • 1 layer of gypsum board on ceiling side 			
	F27a	F27 with <ul style="list-style-type: none"> • no absorptive material in cavity • resilient metal channels spaced 406 mm o.c. • 15.9 mm Type X gypsum board 	—	41	33
	F27b	F27 with <ul style="list-style-type: none"> • no absorptive material in cavity • resilient metal channels spaced 610 mm o.c. • 15.9 mm Type X gypsum board 	—	43	36
	F27c	F27 with <ul style="list-style-type: none"> • absorptive material in cavity • resilient metal channels spaced 406 mm o.c. • 15.9 mm Type X gypsum board 	30 min [45 min] ⁽²⁴⁾	48	41
	F27d	F27 with <ul style="list-style-type: none"> • absorptive material in cavity • resilient metal channels spaced 610 mm o.c. • 15.9 mm Type X gypsum board 	—	50	44
	F27e	F27 with <ul style="list-style-type: none"> • no absorptive material in cavity • resilient metal channels spaced 406 mm o.c. • 12.7 mm Type X gypsum board 	—	40	32
	F27f	F27 with <ul style="list-style-type: none"> • no absorptive material in cavity • resilient metal channels spaced 610 mm o.c. • 12.7 mm Type X gypsum board 	—	42	35
	F27g	F27 with <ul style="list-style-type: none"> • absorptive material in cavity • resilient metal channels spaced 406 mm o.c. • 12.7 mm Type X gypsum board 	—	47	40
	F27h	F27 with <ul style="list-style-type: none"> • absorptive material in cavity • resilient metal channels spaced 610 mm o.c. • 12.7 mm Type X gypsum board 	—	49	43
Column 1	2	3	4	5	6

Table 2 (Cont'd)
Fire and Sound Resistance of Floors, Ceilings and Roofs⁽¹⁾

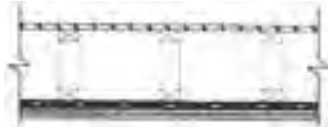
Type of Assembly	Assembly Number	Description ⁽²⁾⁽³⁾⁽⁴⁾	Fire-Resistance Rating ⁽⁵⁾⁽⁶⁾⁽⁷⁾⁽⁸⁾	Typical Sound Transmission Class ⁽⁵⁾⁽⁶⁾⁽⁹⁾⁽¹⁰⁾ (STC)	Typical Impact Insulation Class ⁽⁵⁾⁽⁹⁾⁽¹¹⁾ (IIC)
Floors and Ceilings					
Wood Floor Trusses ⁽²³⁾	F27i	F27 with <ul style="list-style-type: none"> • no absorptive material in cavity • resilient metal channels spaced 406 mm o.c. • 12.7 mm regular gypsum board 	—	39	31
	F27j	F27 with <ul style="list-style-type: none"> • no absorptive material in cavity • resilient metal channels spaced 610 mm o.c. • 12.7 mm regular gypsum board 	—	41	34
	F27k	F27 with <ul style="list-style-type: none"> • absorptive material in cavity • resilient metal channels spaced 406 mm o.c. • 12.7 mm regular gypsum board 	—	46	39
	F27l	F27 with <ul style="list-style-type: none"> • absorptive material in cavity • resilient metal channels spaced 610 mm o.c. • 12.7 mm regular gypsum board 	—	48	42
	F28	<ul style="list-style-type: none"> • subfloor of 15.5 mm plywood, OSB or waferboard, or 17 mm tongue and groove lumber • on wood trusses spaced not more than 610 mm o.c. • with or without absorptive material in cavity • resilient metal channels spaced 406 mm or 610 mm o.c. • 2 layers of gypsum board on ceiling side 			
	F28a	F28 with <ul style="list-style-type: none"> • no absorptive material in cavity • resilient metal channels spaced 406 mm o.c. • 15.9 mm Type X gypsum board 	1 h	46	38
	F28b	F28 with <ul style="list-style-type: none"> • no absorptive material in cavity • resilient metal channels spaced 610 mm o.c. • 15.9 mm Type X gypsum board 	1 h	48	40
	F28c	F28 with <ul style="list-style-type: none"> • absorptive material in cavity • resilient metal channels spaced 406 mm o.c. • 15.9 mm Type X gypsum board 	1 h	54	46
	F28d	F28 with <ul style="list-style-type: none"> • absorptive material in cavity • resilient metal channels spaced 610 mm o.c. • 15.9 mm Type X gypsum board 	45 min [1 h] ⁽¹⁷⁾	55	48
	Column 1	2	3	4	5

Table 2 (Cont'd)
Fire and Sound Resistance of Floors, Ceilings and Roofs⁽¹⁾

Type of Assembly	Assembly Number	Description ⁽²⁾⁽³⁾⁽⁴⁾	Fire-Resistance Rating ⁽⁵⁾⁽⁶⁾⁽⁷⁾⁽⁸⁾	Typical Sound Transmission Class ⁽⁵⁾⁽⁶⁾⁽⁹⁾⁽¹⁰⁾ (STC)	Typical Impact Insulation Class ⁽⁵⁾⁽⁹⁾⁽¹¹⁾ (IIC)
Floors and Ceilings					
Wood Floor Trusses ⁽²³⁾	F28e	F28 with <ul style="list-style-type: none"> • no absorptive material in cavity • resilient metal channels spaced 406 mm o.c. • 12.7 mm Type X gypsum board 	1 h	44	36
	F28f	F28 with <ul style="list-style-type: none"> • no absorptive material in cavity • resilient metal channels spaced 610 mm o.c. • 12.7 mm Type X gypsum board 	1 h	46	39
	F28g	F28 with <ul style="list-style-type: none"> • absorptive material in cavity • resilient metal channels spaced 406 mm o.c. • 12.7 mm Type X gypsum board 	1 h	51	44
	F28h	F28 with <ul style="list-style-type: none"> • absorptive material in cavity • resilient metal channels spaced 610 mm o.c. • 12.7 mm Type X gypsum board 	45 min [1 h] ⁽¹⁷⁾	53	47
	F28i	F28 with <ul style="list-style-type: none"> • no absorptive material in cavity • resilient metal channels spaced 406 mm o.c. • 12.7 mm regular gypsum board 	—	44	36
	F28j	F28 with <ul style="list-style-type: none"> • no absorptive material in cavity • resilient metal channels spaced 610 mm o.c. • 12.7 mm regular gypsum board 	—	46	39
	F28k	F28 with <ul style="list-style-type: none"> • absorptive material in cavity • resilient metal channels spaced 406 mm o.c. • 12.7 mm regular gypsum board 	—	51	44
	F28l	F28 with <ul style="list-style-type: none"> • absorptive material in cavity • resilient metal channels spaced 610 mm o.c. • 12.7 mm regular gypsum board 	—	53	47
Column 1	2	3	4	5	6

Table 2 (Cont'd)
Fire and Sound Resistance of Floors, Ceilings and Roofs⁽¹⁾

Type of Assembly	Assembly Number	Description ⁽²⁾⁽³⁾⁽⁴⁾	Fire-Resistance Rating ⁽⁵⁾⁽⁶⁾⁽⁷⁾⁽⁸⁾	Typical Sound Transmission Class ⁽⁵⁾⁽⁶⁾⁽⁹⁾⁽¹⁰⁾ (STC)	Typical Impact Insulation Class ⁽⁵⁾⁽⁹⁾⁽¹¹⁾ (IIC)
Floors and Ceilings					
Wood Floor Trusses ⁽²³⁾	F29	<ul style="list-style-type: none"> one subfloor layer 11 mm sanded plywood, or OSB or waferboard one subfloor layer of 15.5 mm plywood, OSB or waferboard, or 17 mm tongue and groove lumber on wood trusses spaced not more than 610 mm o.c. with or without absorptive material in cavity resilient metal channels spaced 406 mm or 610 mm o.c. 1 layer of gypsum board on ceiling side 			
	F29a	F29 with <ul style="list-style-type: none"> no absorptive material in cavity resilient metal channels spaced 406 mm o.c. 15.9 mm Type X gypsum board 	—	44	35
	F29b	F29 with <ul style="list-style-type: none"> no absorptive material in cavity resilient metal channels spaced 610 mm o.c. 15.9 mm Type X gypsum board 	—	46	37
	F29c	F29 with <ul style="list-style-type: none"> absorptive material in cavity resilient metal channels spaced 406 mm o.c. 15.9 mm Type X gypsum board 	30 min [45 min] ⁽²⁴⁾	51	43
	F29d	F29 with <ul style="list-style-type: none"> absorptive material in cavity resilient metal channels spaced 610 mm o.c. 15.9 mm Type X gypsum board 	—	53	45
	F29e	F29 with <ul style="list-style-type: none"> no absorptive material in cavity resilient metal channels spaced 406 mm o.c. 12.7 mm Type X gypsum board 	—	43	33
	F29f	F29 with <ul style="list-style-type: none"> no absorptive material in cavity resilient metal channels spaced 610 mm o.c. 12.7 mm Type X gypsum board 	—	45	36
	F29g	F29 with <ul style="list-style-type: none"> absorptive material in cavity resilient metal channels spaced 406 mm o.c. 12.7 mm Type X gypsum board 	—	50	41
	F29h	F29 with <ul style="list-style-type: none"> absorptive material in cavity resilient metal channels spaced 610 mm o.c. 12.7 mm Type X gypsum board 	—	52	44
Column 1	2	3	4	5	6

Table 2 (Cont'd)
Fire and Sound Resistance of Floors, Ceilings and Roofs⁽¹⁾


Type of Assembly	Assembly Number	Description ⁽²⁾⁽³⁾⁽⁴⁾	Fire-Resistance Rating ⁽⁵⁾⁽⁶⁾⁽⁷⁾⁽⁸⁾	Typical Sound Transmission Class ⁽⁵⁾⁽⁶⁾⁽⁹⁾⁽¹⁰⁾ (STC)	Typical Impact Insulation Class ⁽⁵⁾⁽⁹⁾⁽¹¹⁾ (IIC)
Floors and Ceilings					
Wood Floor Trusses ⁽²³⁾	F29i	F29 with <ul style="list-style-type: none"> • no absorptive material in cavity • resilient metal channels spaced 406 mm o.c. • 12.7 mm regular gypsum board 	—	42	34
	F29j	F29 with <ul style="list-style-type: none"> • no absorptive material in cavity • resilient metal channels spaced 610 mm o.c. • 12.7 mm regular gypsum board 	—	44	36
	F29k	F29 with <ul style="list-style-type: none"> • absorptive material in cavity • resilient metal channels spaced 406 mm o.c. • 12.7 mm regular gypsum board 	—	49	41
	F29l	F29 with <ul style="list-style-type: none"> • absorptive material in cavity • resilient metal channels spaced 610 mm o.c. • 12.7 mm regular gypsum board 	—	51	44
	F30	<ul style="list-style-type: none"> • one subfloor layer 11 mm sanded plywood, or OSB or waferboard • one subfloor layer of 15.5 mm plywood, OSB or waferboard, or 17 mm tongue and groove lumber • on wood trusses spaced not more than 610 mm o.c. • with or without absorptive material in cavity • resilient metal channels spaced 406 mm or 610 mm o.c. • 2 layers of gypsum board on ceiling side 			
	F30a	F30 with <ul style="list-style-type: none"> • no absorptive material in cavity • resilient metal channels spaced 406 mm o.c. • 15.9 mm Type X gypsum board 	1 h	49	39
	F30b	F30 with <ul style="list-style-type: none"> • no absorptive material in cavity • resilient metal channels spaced 610 mm o.c. • 15.9 mm Type X gypsum board 	1 h	51	42
	F30c	F30 with <ul style="list-style-type: none"> • absorptive material in cavity • resilient metal channels spaced 406 mm o.c. • 15.9 mm Type X gypsum board 	1 h [1.5 h] ⁽²⁵⁾	56 [58] ⁽²⁵⁾	47 [50] ⁽²⁵⁾
	F30d	F30 with <ul style="list-style-type: none"> • absorptive material in cavity • resilient metal channels spaced 610 mm o.c. • 15.9 mm Type X gypsum board 	45 min [1 h] ⁽¹⁷⁾	58	50
	Column 1	2	3	4	5

Table 2 (Cont'd)
Fire and Sound Resistance of Floors, Ceilings and Roofs⁽¹⁾


Type of Assembly	Assembly Number	Description ⁽²⁾⁽³⁾⁽⁴⁾	Fire-Resistance Rating ⁽⁵⁾⁽⁶⁾⁽⁷⁾⁽⁸⁾	Typical Sound Transmission Class ⁽⁵⁾⁽⁶⁾⁽⁹⁾⁽¹⁰⁾ (STC)	Typical Impact Insulation Class ⁽⁵⁾⁽⁹⁾⁽¹¹⁾ (IIC)
Floors and Ceilings					
Wood Floor Trusses ⁽²³⁾	F30e	F30 with <ul style="list-style-type: none"> • no absorptive material in cavity • resilient metal channels spaced 406 mm o.c. • 12.7 mm Type X gypsum board 	1 h	47	38
	F30f	F30 with <ul style="list-style-type: none"> • no absorptive material in cavity • resilient metal channels spaced 610 mm o.c. • 12.7 mm Type X gypsum board 	1 h	49	40
	F30g	F30 with <ul style="list-style-type: none"> • absorptive material in cavity • resilient metal channels spaced 406 mm o.c. • 12.7 mm Type X gypsum board 	1 h	54	46
	F30h	F30 with <ul style="list-style-type: none"> • absorptive material in cavity • resilient metal channels spaced 610 mm o.c. • 12.7 mm Type X gypsum board 	45 min [1 h] ⁽¹⁷⁾	56	48
	F30i	F30 with <ul style="list-style-type: none"> • no absorptive material in cavity • resilient metal channels spaced 406 mm o.c. • 12.7 mm regular gypsum board 	—	47	37
	F30j	F30 with <ul style="list-style-type: none"> • no absorptive material in cavity • resilient metal channels spaced 610 mm o.c. • 12.7 mm regular gypsum board 	—	49	40
	F30k	F30 with <ul style="list-style-type: none"> • absorptive material in cavity • resilient metal channels spaced 406 mm o.c. • 12.7 mm regular gypsum board 	—	54	45
	F30l	F30 with <ul style="list-style-type: none"> • absorptive material in cavity • resilient metal channels spaced 610 mm o.c. • 12.7 mm regular gypsum board 	—	56	48
	F31	<ul style="list-style-type: none"> • 25 mm gypsum-concrete topping (at least 44 kg/m²) • subfloor of 15.5 mm plywood, OSB or waferboard, or 17 mm tongue and groove lumber • on wood trusses spaced not more than 610 mm o.c. • with or without absorptive material in cavity • 1 layer of gypsum board on ceiling side 			
	Column 1	2	3	4	5

Table 2 (Cont'd)
Fire and Sound Resistance of Floors, Ceilings and Roofs⁽¹⁾

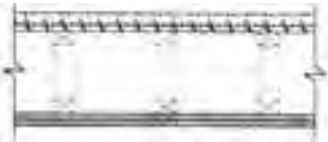
Type of Assembly	Assembly Number	Description ⁽²⁾⁽³⁾⁽⁴⁾	Fire-Resistance Rating ⁽⁵⁾⁽⁶⁾⁽⁷⁾⁽⁸⁾	Typical Sound Transmission Class ⁽⁵⁾⁽⁶⁾⁽⁹⁾⁽¹⁰⁾ (STC)	Typical Impact Insulation Class ⁽⁵⁾⁽⁹⁾⁽¹¹⁾ (IIC)	
Floors and Ceilings						
Wood Floor Trusses ⁽²³⁾	F31a	F31 with <ul style="list-style-type: none"> • no absorptive material in cavity • 15.9 mm Type X gypsum board 	—	41	17	
	F31b	F31 with <ul style="list-style-type: none"> • absorptive material in cavity • 15.9 mm Type X gypsum board 	—	43	20	
	F31c	F31 with <ul style="list-style-type: none"> • no absorptive material in cavity • 12.7 mm Type X gypsum board 	—	40	17	
	F31d	F31 with <ul style="list-style-type: none"> • absorptive material in cavity • 12.7 mm Type X gypsum board 	—	42	20	
	F31e	F31 with <ul style="list-style-type: none"> • no absorptive material in cavity • 12.7 mm regular gypsum board 	—	39	16	
	F31f	F31 with <ul style="list-style-type: none"> • absorptive material in cavity • 12.7 mm regular gypsum board 	—	41	19	
	F32	<ul style="list-style-type: none"> • 25 mm gypsum-concrete topping (at least 44 kg/m²) • subfloor of 15.5 mm plywood, OSB or waferboard, or 17 mm tongue and groove lumber • on wood trusses spaced not more than 610 mm o.c. • with or without absorptive material in cavity • 2 layers of gypsum board on ceiling side 				
	F32a	F32 with <ul style="list-style-type: none"> • wood trusses spaced 406 mm o.c. • no absorptive material in cavity • 15.9 mm Type X gypsum board 	1 h	46	20	
	F32b	F32 with <ul style="list-style-type: none"> • wood trusses spaced 610 mm o.c. • no absorptive material in cavity • 15.9 mm Type X gypsum board 	1 h	47	20	
	F32c	F32 with <ul style="list-style-type: none"> • wood trusses spaced 406 mm o.c. • absorptive material in cavity • 15.9 mm Type X gypsum board 	45 min [1 h] ⁽¹⁴⁾	48	23	
	Column 1	2	3	4	5	6

Table 2 (Cont'd)
Fire and Sound Resistance of Floors, Ceilings and Roofs⁽¹⁾

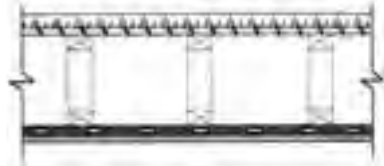
Type of Assembly	Assembly Number	Description ⁽²⁾⁽³⁾⁽⁴⁾	Fire-Resistance Rating ⁽⁵⁾⁽⁶⁾⁽⁷⁾⁽⁸⁾	Typical Sound Transmission Class ⁽⁵⁾⁽⁶⁾⁽⁹⁾⁽¹⁰⁾ (STC)	Typical Impact Insulation Class ⁽⁵⁾⁽⁹⁾⁽¹¹⁾ (IIC)
Floors and Ceilings					
Wood Floor Trusses ⁽²³⁾	F32d	F32 with <ul style="list-style-type: none"> • wood trusses spaced 610 mm o.c. • absorptive material in cavity • 15.9 mm Type X gypsum board 	45 min	49	23
	F32e	F32 with <ul style="list-style-type: none"> • wood trusses spaced 406 mm o.c. • no absorptive material in cavity • 12.7 mm Type X gypsum board 	1 h	44	19
	F32f	F32 with <ul style="list-style-type: none"> • wood trusses spaced 610 mm o.c. • no absorptive material in cavity • 12.7 mm Type X gypsum board 	45 min	45	19
	F32g	F32 with <ul style="list-style-type: none"> • absorptive material in cavity • 12.7 mm Type X gypsum board 	—	46	19
	F32h	F32 with <ul style="list-style-type: none"> • no absorptive material in cavity • 12.7 mm regular gypsum board 	—	44	19
	F32i	F32 with <ul style="list-style-type: none"> • absorptive material in cavity • 12.7 mm regular gypsum board 	—	46	22
	F33	<ul style="list-style-type: none"> • 25 mm gypsum-concrete topping (at least 44 kg/m²) • subfloor of 15.5 mm plywood, OSB or waferboard, or 17 mm tongue and groove lumber • on wood trusses spaced not more than 610 mm o.c. • with or without absorptive material in cavity • resilient metal channels spaced 406 mm or 610 mm o.c. • 1 layer of gypsum board on ceiling side 			
	F33a	F33 with <ul style="list-style-type: none"> • no absorptive material in cavity • resilient metal channels spaced 406 mm o.c. • 15.9 mm Type X gypsum board 	—	53	26
	F33b	F33 with <ul style="list-style-type: none"> • no absorptive material in cavity • resilient metal channels spaced 610 mm o.c. • 15.9 mm Type X gypsum board 	—	55	26
	Column 1	2	3	4	5

Table 2 (Cont'd)
Fire and Sound Resistance of Floors, Ceilings and Roofs⁽¹⁾

Type of Assembly	Assembly Number	Description ⁽²⁾⁽³⁾⁽⁴⁾	Fire-Resistance Rating ⁽⁵⁾⁽⁶⁾⁽⁷⁾⁽⁸⁾	Typical Sound Transmission Class ⁽⁵⁾⁽⁶⁾⁽⁹⁾⁽¹⁰⁾ (STC)	Typical Impact Insulation Class ⁽⁵⁾⁽⁹⁾⁽¹¹⁾ (IIC)
Floors and Ceilings					
Wood Floor Trusses ⁽²³⁾	F33c	F33 with <ul style="list-style-type: none"> • absorptive material in cavity • resilient metal channels spaced 406 mm o.c. • 15.9 mm Type X gypsum board 	30 min [45 min] ⁽²⁴⁾	60	34
	F33d	F33 with <ul style="list-style-type: none"> • absorptive material in cavity • resilient metal channels spaced 610 mm o.c. • 15.9 mm Type X gypsum board 	—	62	34
	F33e	F33 with <ul style="list-style-type: none"> • no absorptive material in cavity • resilient metal channels spaced 406 mm o.c. • 12.7 mm Type X gypsum board 	—	52	26
	F33f	F33 with <ul style="list-style-type: none"> • no absorptive material in cavity • resilient metal channels spaced 610 mm o.c. • 12.7 mm Type X gypsum board 	—	54	26
	F33g	F33 with <ul style="list-style-type: none"> • absorptive material in cavity • resilient metal channels spaced 406 mm o.c. • 12.7 mm Type X gypsum board 	—	59	34
	F33h	F33 with <ul style="list-style-type: none"> • absorptive material in cavity • resilient metal channels spaced 610 mm o.c. • 12.7 mm Type X gypsum board 	—	61	34
	F33i	F33 with <ul style="list-style-type: none"> • no absorptive material in cavity • resilient metal channels spaced 406 mm o.c. • 12.7 mm regular gypsum board 	—	51	25
	F33j	F33 with <ul style="list-style-type: none"> • no absorptive material in cavity • resilient metal channels spaced 610 mm o.c. • 12.7 mm regular gypsum board 	—	53	25
	F33k	F33 with <ul style="list-style-type: none"> • absorptive material in cavity • resilient metal channels spaced 406 mm o.c. • 12.7 mm regular gypsum board 	—	58	33
	F33l	F33 with <ul style="list-style-type: none"> • absorptive material in cavity • resilient metal channels spaced 610 mm o.c. • 12.7 mm regular gypsum board 	—	60	33
Column 1	2	3	4	5	6

Table 2 (Cont'd)
Fire and Sound Resistance of Floors, Ceilings and Roofs⁽¹⁾


Type of Assembly	Assembly Number	Description ⁽²⁾⁽³⁾⁽⁴⁾	Fire-Resistance Rating ⁽⁵⁾⁽⁶⁾⁽⁷⁾⁽⁸⁾	Typical Sound Transmission Class ⁽⁵⁾⁽⁶⁾⁽⁹⁾⁽¹⁰⁾ (STC)	Typical Impact Insulation Class ⁽⁵⁾⁽⁹⁾⁽¹¹⁾ (IIC)
Floors and Ceilings					
Wood Floor Trusses ⁽²³⁾	F34	<ul style="list-style-type: none"> • 25 mm gypsum-concrete topping (at least 44 kg/m²) • subfloor of 15.5 mm plywood, OSB or waferboard, or 17 mm tongue and groove lumber • on wood trusses spaced not more than 610 mm o.c. • with or without absorptive material in cavity • resilient metal channels spaced 406 mm or 610 mm o.c. • 2 layers of gypsum board on ceiling side 			
	F34a	F34 with <ul style="list-style-type: none"> • no absorptive material in cavity • resilient metal channels spaced 406 mm o.c. • 15.9 mm Type X gypsum board 	1 h	57	29
	F34b	F34 with <ul style="list-style-type: none"> • no absorptive material in cavity • resilient metal channels spaced 610 mm o.c. • 15.9 mm Type X gypsum board 	1 h	60	29
	F34c	F34 with <ul style="list-style-type: none"> • absorptive material in cavity • resilient metal channels spaced 406 mm o.c. • 15.9 mm Type X gypsum board 	1 h [1.5 h] ⁽²⁵⁾	65 [67] ⁽²⁵⁾	37
	F34d	F34 with <ul style="list-style-type: none"> • absorptive material in cavity • resilient metal channels spaced 610 mm o.c. • 15.9 mm Type X gypsum board 	45 min [1 h] ⁽¹⁷⁾	67	37
	F34e	F34 with <ul style="list-style-type: none"> • no absorptive material in cavity • resilient metal channels spaced 406 mm o.c. • 12.7 mm Type X gypsum board 	1 h	56	28
	F34f	F34 with <ul style="list-style-type: none"> • no absorptive material in cavity • resilient metal channels spaced 610 mm o.c. • 12.7 mm Type X gypsum board 	1 h	58	28
	F34g	F34 with <ul style="list-style-type: none"> • absorptive material in cavity • resilient metal channels spaced 406 mm o.c. • 12.7 mm Type X gypsum board 	1 h	63	36
Column 1	2	3	4	5	6

Table 2 (Cont'd)
Fire and Sound Resistance of Floors, Ceilings and Roofs⁽¹⁾


Type of Assembly	Assembly Number	Description ⁽²⁾⁽³⁾⁽⁴⁾	Fire-Resistance Rating ⁽⁵⁾⁽⁶⁾⁽⁷⁾⁽⁸⁾	Typical Sound Transmission Class ⁽⁵⁾⁽⁶⁾⁽⁹⁾⁽¹⁰⁾ (STC)	Typical Impact Insulation Class ⁽⁵⁾⁽⁹⁾⁽¹¹⁾ (IIC)	
Floors and Ceilings						
Wood Floor Trusses ⁽²³⁾	F34h	F34 with <ul style="list-style-type: none"> • absorptive material in cavity • resilient metal channels spaced 610 mm o.c. • 12.7 mm Type X gypsum board 	45 min [1 h] ⁽¹⁷⁾	65	36	
	F34i	F34 with <ul style="list-style-type: none"> • no absorptive material in cavity • resilient metal channels spaced 406 mm o.c. • 12.7 mm regular gypsum board 	—	56	28	
	F34j	F34 with <ul style="list-style-type: none"> • no absorptive material in cavity • resilient metal channels spaced 610 mm o.c. • 12.7 mm regular gypsum board 	—	58	28	
	F34k	F34 with <ul style="list-style-type: none"> • absorptive material in cavity • resilient metal channels spaced 406 mm o.c. • 12.7 mm regular gypsum board 	—	63	36	
	F34l	F34 with <ul style="list-style-type: none"> • absorptive material in cavity • resilient metal channels spaced 610 mm o.c. • 12.7 mm regular gypsum board 	—	65	36	
	F35	<ul style="list-style-type: none"> • 38 mm concrete topping (at least 70 kg/m²) • subfloor of 15.5 mm plywood, OSB or waferboard, or 17 mm tongue and groove lumber • on wood trusses spaced not more than 610 mm o.c. • with or without absorptive material in cavity • 1 layer of gypsum board on ceiling side 				
	F35a	F35 with <ul style="list-style-type: none"> • no absorptive material in cavity • 15.9 mm Type X gypsum board 	—	45	26	
	F35b	F35 with <ul style="list-style-type: none"> • absorptive material in cavity • 15.9 mm Type X gypsum board 	—	47	29	
	F35c	F35 with <ul style="list-style-type: none"> • no absorptive material in cavity • 12.7 mm Type X gypsum board 	—	43	26	
	F35d	F35 with <ul style="list-style-type: none"> • absorptive material in cavity • 12.7 mm Type X gypsum board 	—	45	29	
	Column 1	2	3	4	5	6

Table 2 (Cont'd)
Fire and Sound Resistance of Floors, Ceilings and Roofs⁽¹⁾

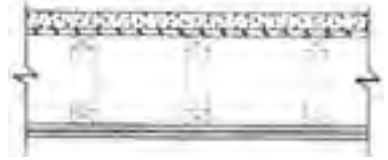
Type of Assembly	Assembly Number	Description ⁽²⁾⁽³⁾⁽⁴⁾	Fire-Resistance Rating ⁽⁵⁾⁽⁶⁾⁽⁷⁾⁽⁸⁾	Typical Sound Transmission Class ⁽⁵⁾⁽⁶⁾⁽⁹⁾⁽¹⁰⁾ (STC)	Typical Impact Insulation Class ⁽⁵⁾⁽⁹⁾⁽¹¹⁾ (IIC)
Floors and Ceilings					
Wood Floor Trusses ⁽²³⁾	F35e	F35 with <ul style="list-style-type: none"> • no absorptive material in cavity • 12.7 mm regular gypsum board 	—	43	26
	F35f	F35 with <ul style="list-style-type: none"> • absorptive material in cavity • 12.7 mm regular gypsum board 	—	45	29
	F36	<ul style="list-style-type: none"> • 38 mm concrete topping (at least 70 kg/m²) • subfloor of 15.5 mm plywood, OSB or waferboard, or 17 mm tongue and groove lumber • on wood trusses spaced not more than 610 mm o.c. • with or without absorptive material in cavity • 2 layers of gypsum board on ceiling side 			
	F36a	F36 with <ul style="list-style-type: none"> • wood trusses spaced 406 mm o.c. • no absorptive material in cavity • 15.9 mm Type X gypsum board 	1 h	49	28
	F36b	F36 with <ul style="list-style-type: none"> • wood trusses spaced 610 mm o.c. • no absorptive material in cavity • 15.9 mm Type X gypsum board 	1 h	50	28
	F36c	F36 with <ul style="list-style-type: none"> • wood trusses spaced 406 mm o.c. • absorptive material in cavity • 15.9 mm Type X gypsum board 	45 min [1 h] ⁽¹⁴⁾	51	31
	F36d	F36 with <ul style="list-style-type: none"> • wood trusses spaced 610 mm o.c. • absorptive material in cavity • 15.9 mm Type X gypsum board 	45 min	52	31
	F36e	F36 with <ul style="list-style-type: none"> • wood trusses spaced 406 mm o.c. • no absorptive material in cavity • 12.7 mm Type X gypsum board 	1 h	48	27
	F36f	F36 with <ul style="list-style-type: none"> • wood trusses spaced 610 mm o.c. • no absorptive material in cavity • 12.7 mm Type X gypsum board 	45 min	49	27
	Column 1	2	3	4	5

Table 2 (Cont'd)
Fire and Sound Resistance of Floors, Ceilings and Roofs⁽¹⁾


Type of Assembly	Assembly Number	Description ⁽²⁾⁽³⁾⁽⁴⁾	Fire-Resistance Rating ⁽⁵⁾⁽⁶⁾⁽⁷⁾⁽⁸⁾	Typical Sound Transmission Class ⁽⁵⁾⁽⁶⁾⁽⁹⁾⁽¹⁰⁾ (STC)	Typical Impact Insulation Class ⁽⁵⁾⁽⁹⁾⁽¹¹⁾ (IIC)
Floors and Ceilings					
Wood Floor Trusses ⁽²³⁾	F36g	F36 with <ul style="list-style-type: none"> • absorptive material in cavity • 12.7 mm Type X gypsum board 	—	50	30
	F36h	F36 with <ul style="list-style-type: none"> • no absorptive material in cavity • 12.7 mm regular gypsum board 	—	47	27
	F36i	F36 with <ul style="list-style-type: none"> • absorptive material in cavity • 12.7 mm regular gypsum board 	—	49	30
	F37	<ul style="list-style-type: none"> • 38 mm concrete topping (at least 70 kg/m²) • subfloor of 15.5 mm plywood, OSB or waferboard, or 17 mm tongue and groove lumber • on wood trusses spaced not more than 610 mm o.c. • with or without absorptive material in cavity • resilient metal channels spaced 406 mm or 610 mm o.c. • 1 layer of gypsum board on ceiling side 			
	F37a	F37 with <ul style="list-style-type: none"> • no absorptive material in cavity • resilient metal channels spaced 406 mm o.c. • 15.9 mm Type X gypsum board 	45 min	56	35
	F37b	F37 with <ul style="list-style-type: none"> • no absorptive material in cavity • resilient metal channels spaced 610 mm o.c. • 15.9 mm Type X gypsum board 	—	59	35
	F37c	F37 with <ul style="list-style-type: none"> • absorptive material in cavity • resilient metal channels spaced 406 mm o.c. • 15.9 mm Type X gypsum board 	30 min [45 min] ⁽²⁴⁾	63	43
	F37d	F37 with <ul style="list-style-type: none"> • absorptive material in cavity • resilient metal channels spaced 610 mm o.c. • 15.9 mm Type X gypsum board 	—	66	43
	F37e	F37 with <ul style="list-style-type: none"> • no absorptive material in cavity • resilient metal channels spaced 406 mm o.c. • 12.7 mm Type X gypsum board 	—	55	35
	Column 1	2	3	4	5

Table 2 (Cont'd)
Fire and Sound Resistance of Floors, Ceilings and Roofs⁽¹⁾


Type of Assembly	Assembly Number	Description ⁽²⁾⁽³⁾⁽⁴⁾	Fire-Resistance Rating ⁽⁵⁾⁽⁶⁾⁽⁷⁾⁽⁸⁾	Typical Sound Transmission Class ⁽⁵⁾⁽⁶⁾⁽⁹⁾⁽¹⁰⁾ (STC)	Typical Impact Insulation Class ⁽⁵⁾⁽⁹⁾⁽¹¹⁾ (IIC)
Floors and Ceilings					
Wood Floor Trusses ⁽²³⁾	F37f	F37 with <ul style="list-style-type: none"> • no absorptive material in cavity • resilient metal channels spaced 610 mm o.c. • 12.7 mm Type X gypsum board 	—	57	35
	F37g	F37 with <ul style="list-style-type: none"> • absorptive material in cavity • resilient metal channels spaced 406 mm o.c. • 12.7 mm Type X gypsum board 	—	62	43
	F37h	F37 with <ul style="list-style-type: none"> • absorptive material in cavity • resilient metal channels spaced 610 mm o.c. • 12.7 mm Type X gypsum board 	—	64	43
	F37i	F37 with <ul style="list-style-type: none"> • no absorptive material in cavity • resilient metal channels spaced 406 mm o.c. • 12.7 mm regular gypsum board 	—	54	35
	F37j	F37 with <ul style="list-style-type: none"> • no absorptive material in cavity • resilient metal channels spaced 610 mm o.c. • 12.7 mm regular gypsum board 	—	57	35
	F37k	F37 with <ul style="list-style-type: none"> • absorptive material in cavity • resilient metal channels spaced 406 mm o.c. • 12.7 mm regular gypsum board 	—	61	43
	F37l	F37 with <ul style="list-style-type: none"> • absorptive material in cavity • resilient metal channels spaced 610 mm o.c. • 12.7 mm regular gypsum board 	—	64	43
	F38	<ul style="list-style-type: none"> • 38 mm concrete topping (at least 70 kg/m²) • subfloor of 15.5 mm plywood, OSB or waferboard, or 17 mm tongue and groove lumber • on wood trusses spaced not more than 610 mm o.c. • with or without absorptive material in cavity • resilient metal channels spaced 406 mm or 610 mm o.c. • 2 layers of gypsum board on ceiling side 			
	F38a	F38 with <ul style="list-style-type: none"> • no absorptive material in cavity • resilient metal channels spaced 406 mm o.c. • 15.9 mm Type X gypsum board 	1 h	61	37
	Column 1	2	3	4	5

Table 2 (Cont'd)
Fire and Sound Resistance of Floors, Ceilings and Roofs⁽¹⁾

Type of Assembly	Assembly Number	Description ⁽²⁾⁽³⁾⁽⁴⁾	Fire-Resistance Rating ⁽⁵⁾⁽⁶⁾⁽⁷⁾⁽⁸⁾	Typical Sound Transmission Class ⁽⁵⁾⁽⁶⁾⁽⁹⁾⁽¹⁰⁾ (STC)	Typical Impact Insulation Class ⁽⁵⁾⁽⁹⁾⁽¹¹⁾ (IIC)
Floors and Ceilings					
Wood Floor Trusses ⁽²³⁾	F38b	F38 with <ul style="list-style-type: none"> • no absorptive material in cavity • resilient metal channels spaced 610 mm o.c • 15.9 mm Type X gypsum board 	1 h	63	37
	F38c	F38 with <ul style="list-style-type: none"> • absorptive material in cavity • resilient metal channels spaced 406 mm o.c. • 15.9 mm Type X gypsum board 	1 h [1.5 h] ⁽²⁵⁾	69 [71] ⁽²⁵⁾	45
	F38d	F38 with <ul style="list-style-type: none"> • absorptive material in cavity • resilient metal channels spaced 610 mm o.c. • 15.9 mm Type X gypsum board 	1 h	70	45
	F38e	F38 with <ul style="list-style-type: none"> • no absorptive material in cavity • resilient metal channels spaced 406 mm o.c. • 12.7 mm Type X gypsum board 	1 h	60	36
	F38f	F38 with <ul style="list-style-type: none"> • no absorptive material in cavity • resilient metal channels spaced 610 mm o.c. • 12.7 mm Type X gypsum board 	1 h	62	36
	F38g	F38 with <ul style="list-style-type: none"> • absorptive material in cavity • resilient metal channels spaced 406 mm o.c. • 12.7 mm Type X gypsum board 	1 h	67	44
	F38h	F38 with <ul style="list-style-type: none"> • absorptive material in cavity • resilient metal channels spaced 610 mm o.c. • 12.7 mm Type X gypsum board 	1 h	69	44
	F38i	F38 with <ul style="list-style-type: none"> • no absorptive material in cavity • resilient metal channels spaced 406 mm o.c. • 12.7 mm regular gypsum board 	—	59	36
	F38j	F38 with <ul style="list-style-type: none"> • no absorptive material in cavity • resilient metal channels spaced 610 mm o.c. • 12.7 mm regular gypsum board 	—	61	36
	F38k	F38 with <ul style="list-style-type: none"> • absorptive material in cavity • resilient metal channels spaced 406 mm o.c. • 12.7 mm regular gypsum board 	—	66	44
	Column 1	2	3	4	5

Table 2 (Cont'd)
Fire and Sound Resistance of Floors, Ceilings and Roofs⁽¹⁾

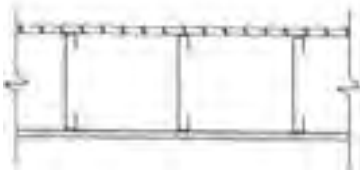
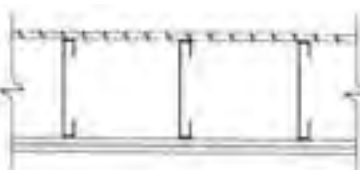
Type of Assembly	Assembly Number	Description ⁽²⁾⁽³⁾⁽⁴⁾	Fire-Resistance Rating ⁽⁵⁾⁽⁶⁾⁽⁷⁾⁽⁸⁾	Typical Sound Transmission Class ⁽⁵⁾⁽⁶⁾⁽⁹⁾⁽¹⁰⁾ (STC)	Typical Impact Insulation Class ⁽⁵⁾⁽⁹⁾⁽¹¹⁾ (IIC)
Floors and Ceilings					
Wood Floor Trusses ⁽²³⁾	F38l	F38 with <ul style="list-style-type: none"> • absorptive material in cavity • resilient metal channels spaced 610 mm o.c. • 12.7 mm regular gypsum board 	—	68	44
Cold Formed Steel Floor Joists ⁽²⁶⁾	F39	<ul style="list-style-type: none"> • subfloor of 15.5 mm plywood, OSB or waferboard, or 17 mm tongue and groove lumber • on steel joists spaced not more than 610 mm o.c. • with or without absorptive material in cavity • 1 layer of gypsum board on ceiling side 			
	F39a	F39 with <ul style="list-style-type: none"> • no absorptive material in cavity • 15.9 mm Type X gypsum board 	—	29	27
	F39b	F39 with <ul style="list-style-type: none"> • absorptive material in cavity • 15.9 mm Type X gypsum board 	—	31	30
	F39c	F39 with <ul style="list-style-type: none"> • no absorptive material in cavity • 12.7 mm Type X gypsum board 	—	27	26
	F39d	F39 with <ul style="list-style-type: none"> • absorptive material in cavity • 12.7 mm Type X gypsum board 	—	29	29
	F39e	F39 with <ul style="list-style-type: none"> • no absorptive material in cavity • 12.7 mm regular gypsum board 	—	27	25
	F39f	F39 with <ul style="list-style-type: none"> • absorptive material in cavity • 12.7 mm regular gypsum board 	—	29	28
	F40	<ul style="list-style-type: none"> • subfloor of 15.5 mm plywood, OSB or waferboard, or 17 mm tongue and groove lumber • on steel joists spaced not more than 610 mm o.c. • with or without absorptive material in cavity • 2 layers of gypsum board on ceiling side 			
	F40a	F40 with <ul style="list-style-type: none"> • steel joists spaced 406 mm o.c. • no absorptive material in cavity • 15.9 mm Type X gypsum board 	1 h	34	31
	Column 1	2	3	4	5

Table 2 (Cont'd)
Fire and Sound Resistance of Floors, Ceilings and Roofs⁽¹⁾

Type of Assembly	Assembly Number	Description ⁽²⁾⁽³⁾⁽⁴⁾	Fire-Resistance Rating ⁽⁵⁾⁽⁶⁾⁽⁷⁾⁽⁸⁾	Typical Sound Transmission Class ⁽⁵⁾⁽⁶⁾⁽⁹⁾⁽¹⁰⁾ (STC)	Typical Impact Insulation Class ⁽⁵⁾⁽⁹⁾⁽¹¹⁾ (IIC)
Floors and Ceilings					
Cold Formed Steel Floor Joists ⁽²⁶⁾	F40b	F40 with <ul style="list-style-type: none"> • steel joists spaced 610 mm o.c. • no absorptive material in cavity • 15.9 mm Type X gypsum board 	45 min	35	31
	F40c	F40 with <ul style="list-style-type: none"> • steel joists spaced 406 mm o.c. • absorptive material in cavity • 15.9 mm Type X gypsum board 	45 min	36	34
	F40d	F40 with <ul style="list-style-type: none"> • steel joists spaced 610 mm o.c. • absorptive material in cavity • 15.9 mm Type X gypsum board 	45 min	37	34
	F40e	F40 with <ul style="list-style-type: none"> • steel joists spaced 406 mm o.c. • no absorptive material in cavity • 12.7 mm Type X gypsum board 	1 h	32	30
	F40f	F40 with <ul style="list-style-type: none"> • steel joists spaced 610 mm o.c. • no absorptive material in cavity • 12.7 mm Type X gypsum board 	45 min	33	30
	F40g	F40 with <ul style="list-style-type: none"> • steel joists spaced 406 mm o.c. • absorptive material in cavity • 12.7 mm Type X gypsum board 	45 min	34	33
	F40h	F40 with <ul style="list-style-type: none"> • steel joists spaced 610 mm o.c. • absorptive material in cavity • 12.7 mm Type X gypsum board 	45 min	35	33
	F40i	F40 with <ul style="list-style-type: none"> • no absorptive material in cavity • 12.7 mm regular gypsum board 	—	31	30
	F40j	F40 with <ul style="list-style-type: none"> • absorptive material in cavity • 12.7 mm regular gypsum board 	—	33	33
	Column 1	2	3	4	5

Table 2 (Cont'd)
Fire and Sound Resistance of Floors, Ceilings and Roofs⁽¹⁾

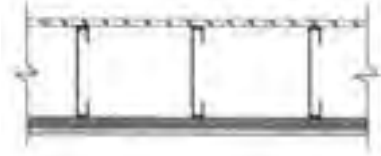
Type of Assembly	Assembly Number	Description ⁽²⁾⁽³⁾⁽⁴⁾	Fire-Resistance Rating ⁽⁵⁾⁽⁶⁾⁽⁷⁾⁽⁸⁾	Typical Sound Transmission Class ⁽⁵⁾⁽⁶⁾⁽⁹⁾⁽¹⁰⁾ (STC)	Typical Impact Insulation Class ⁽⁵⁾⁽⁹⁾⁽¹¹⁾ (IIC)
Floors and Ceilings					
Cold Formed Steel Floor Joists ⁽²⁶⁾	F41	<ul style="list-style-type: none"> • subfloor of 15.5 mm plywood, OSB or waferboard, or 17 mm tongue and groove lumber • on steel joists spaced not more than 610 mm o.c. • with or without absorptive material in cavity • steel furring channels spaced 406 mm or 610 mm o.c. • 1 layer of gypsum board on ceiling side 			
	F41a	F41 with <ul style="list-style-type: none"> • no absorptive material in cavity • steel furring channels spaced 406 mm o.c. • 15.9 mm Type X gypsum board 	—	34	27
	F41b	F41 with <ul style="list-style-type: none"> • no absorptive material in cavity • steel furring channels spaced 610 mm o.c. • 15.9 mm Type X gypsum board 	—	37	30
	F41c	F41 with <ul style="list-style-type: none"> • absorptive material in cavity • steel furring channels spaced 406 mm o.c. • 15.9 mm Type X gypsum board 	30 min [45 min] ⁽²⁴⁾	37	30
	F41d	F41 with <ul style="list-style-type: none"> • absorptive material in cavity • steel furring channels spaced 610 mm o.c. • 15.9 mm Type X gypsum board 	30 min	40	33
	F41e	F41 with <ul style="list-style-type: none"> • no absorptive material in cavity • steel furring channels spaced 406 mm o.c. • 12.7 mm Type X gypsum board 	—	33	26
	F41f	F41 with <ul style="list-style-type: none"> • no absorptive material in cavity • steel furring channels spaced 610 mm o.c. • 12.7 mm Type X gypsum board 	—	35	29
	F41g	F41 with <ul style="list-style-type: none"> • absorptive material in cavity • steel furring channels spaced 406 mm o.c. • 12.7 mm Type X gypsum board 	30 min [45 min] ⁽²⁴⁾	36	29
	F41h	F41 with <ul style="list-style-type: none"> • absorptive material in cavity • steel furring channels spaced 610 mm o.c. • 12.7 mm Type X gypsum board 	30 min	38	32
Column 1	2	3	4	5	6

Table 2 (Cont'd)
Fire and Sound Resistance of Floors, Ceilings and Roofs⁽¹⁾

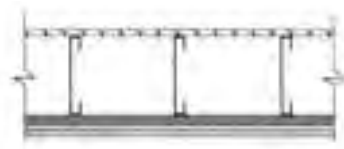
Type of Assembly	Assembly Number	Description ⁽²⁾⁽³⁾⁽⁴⁾	Fire-Resistance Rating ⁽⁵⁾⁽⁶⁾⁽⁷⁾⁽⁸⁾	Typical Sound Transmission Class ⁽⁵⁾⁽⁶⁾⁽⁹⁾⁽¹⁰⁾ (STC)	Typical Impact Insulation Class ⁽⁵⁾⁽⁹⁾⁽¹¹⁾ (IIC)
Floors and Ceilings					
Cold Formed Steel Floor Joists ⁽²⁶⁾	F41i	F41 with <ul style="list-style-type: none"> no absorptive material in cavity steel furring channels spaced 406 mm o.c. 12.7 mm regular gypsum board 	< 30 min	32	25
	F41j	F41 with <ul style="list-style-type: none"> no absorptive material in cavity steel furring channels spaced 610 mm o.c. 12.7 mm regular gypsum board 	< 30 min	35	28
	F41k	F41 with <ul style="list-style-type: none"> absorptive material in cavity steel furring channels spaced 406 mm o.c. 12.7 mm regular gypsum board 	< 30 min	35	28
	F41l	F41 with <ul style="list-style-type: none"> absorptive material in cavity steel furring channels spaced 610 mm o.c. 12.7 mm regular gypsum board 	< 30 min	38	31
	F42	<ul style="list-style-type: none"> subfloor of 15.5 mm plywood, OSB or waferboard, or 17 mm tongue and groove lumber on steel joists spaced not more than 610 mm o.c. with or without absorptive material in cavity steel furring channels spaced 406 mm or 610 mm o.c. 2 layers of gypsum board on ceiling side 			
	F42a	F42 with <ul style="list-style-type: none"> no absorptive material in cavity steel furring channels spaced 406 mm o.c. 15.9 mm Type X gypsum board 	1 h	39	32
	F42b	F42 with <ul style="list-style-type: none"> steel joists spaced 406 mm o.c. no absorptive material in cavity steel furring channels spaced 610 mm o.c. 15.9 mm Type X gypsum board 	45 min	42	34
	F42c	F42 with <ul style="list-style-type: none"> steel joists spaced 610 mm o.c. no absorptive material in cavity steel furring channels spaced 610 mm o.c. 15.9 mm Type X gypsum board 	45 min	43	34
	F42d	F42 with <ul style="list-style-type: none"> absorptive material in cavity steel furring channels spaced 406 mm o.c. 15.9 mm Type X gypsum board 	1 h	42	35
	Column 1	2	3	4	5

Table 2 (Cont'd)
Fire and Sound Resistance of Floors, Ceilings and Roofs⁽¹⁾

Type of Assembly	Assembly Number	Description ⁽²⁾⁽³⁾⁽⁴⁾	Fire-Resistance Rating ⁽⁵⁾⁽⁶⁾⁽⁷⁾⁽⁸⁾	Typical Sound Transmission Class ⁽⁵⁾⁽⁶⁾⁽⁹⁾⁽¹⁰⁾ (STC)	Typical Impact Insulation Class ⁽⁵⁾⁽⁹⁾⁽¹¹⁾ (IIC)
Floors and Ceilings					
Cold Formed Steel Floor Joists ⁽²⁶⁾	F42e	F42 with <ul style="list-style-type: none"> • steel joists spaced 406 mm o.c. • absorptive material in cavity • steel furring channels spaced 610 mm o.c. • 15.9 mm Type X gypsum board 	45 min [1 h] ⁽²⁷⁾	45	37
	F42f	F42 with <ul style="list-style-type: none"> • steel joists spaced 610 mm o.c. • absorptive material in cavity • steel furring channels spaced 610 mm o.c. • 15.9 mm Type X gypsum board 	45 min [1 h] ⁽¹⁴⁾	46	37
	F42g	F42 with <ul style="list-style-type: none"> • no absorptive material in cavity • steel furring channels spaced 406 mm o.c. • 12.7 mm Type X gypsum board 	1 h	38	30
	F42h	F42 with <ul style="list-style-type: none"> • steel joists spaced 406 mm o.c. • no absorptive material in cavity • steel furring channels spaced 610 mm o.c. • 12.7 mm Type X gypsum board 	45 min	40	33
	F42i	F42 with <ul style="list-style-type: none"> • steel joists spaced 610 mm o.c. • no absorptive material in cavity • steel furring channels spaced 610 mm o.c. • 12.7 mm Type X gypsum board 	45 min	41	33
	F42j	F42 with <ul style="list-style-type: none"> • absorptive material in cavity • steel furring channels spaced 406 mm o.c. • 12.7 mm Type X gypsum board 	1 h	41	33
	F42k	F42 with <ul style="list-style-type: none"> • steel joists spaced 406 mm o.c. • absorptive material in cavity • steel furring channels spaced 610 mm o.c. • 12.7 mm Type X gypsum board 	45 min [1 h] ⁽²⁷⁾	43	36
	F42l	F42 with <ul style="list-style-type: none"> • steel joists spaced 610 mm o.c. • absorptive material in cavity • steel furring channels spaced 610 mm o.c. • 12.7 mm Type X gypsum board 	45 min [1 h] ⁽¹⁴⁾	44	36
	F42m	F42 with <ul style="list-style-type: none"> • no absorptive material in cavity • steel furring channels spaced 406 mm o.c. • 12.7 mm regular gypsum board 	—	37	30
Column 1	2	3	4	5	6

Table 2 (Cont'd)
Fire and Sound Resistance of Floors, Ceilings and Roofs⁽¹⁾

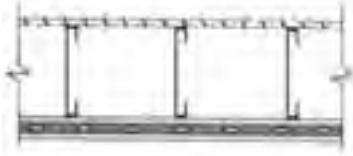
Type of Assembly	Assembly Number	Description ⁽²⁾⁽³⁾⁽⁴⁾	Fire-Resistance Rating ⁽⁵⁾⁽⁶⁾⁽⁷⁾⁽⁸⁾	Typical Sound Transmission Class ⁽⁵⁾⁽⁶⁾⁽⁹⁾⁽¹⁰⁾ (STC)	Typical Impact Insulation Class ⁽⁵⁾⁽⁹⁾⁽¹¹⁾ (IIC)
Floors and Ceilings					
Cold Formed Steel Floor Joists ⁽²⁶⁾	F42n	F42 with <ul style="list-style-type: none"> no absorptive material in cavity steel furring channels spaced 610 mm o.c. 12.7 mm regular gypsum board 	—	39	33
	F42o	F42 with <ul style="list-style-type: none"> absorptive material in cavity steel furring channels spaced 406 mm o.c. 12.7 mm regular gypsum board 	—	40	33
	F42p	F42 with <ul style="list-style-type: none"> absorptive material in cavity steel furring channels spaced 610 mm o.c. 12.7 mm regular gypsum board 	—	42	36
	F43	<ul style="list-style-type: none"> subfloor of 15.5 mm plywood, OSB or waferboard, or 17 mm tongue and groove lumber on steel joists spaced not more than 610 mm o.c. with or without absorptive material in cavity 1 layer of gypsum board attached directly to joists on ceiling side resilient metal channels spaced 406 mm or 610 mm o.c. attached to joists through the gypsum board 1 layer of gypsum board attached to resilient metal channels 			
	F43a	F43 with <ul style="list-style-type: none"> no absorptive material in cavity 15.9 mm Type X gypsum board resilient metal channels 15.9 mm Type X gypsum board 	1 h	35	37
	F43b	F43 with <ul style="list-style-type: none"> absorptive material in cavity 15.9 mm Type X gypsum board resilient metal channels 15.9 mm Type X gypsum board 	1 h	37	30
	F43c	F43 with <ul style="list-style-type: none"> no absorptive material in cavity 12.7 mm Type X gypsum board resilient metal channels 12.7 mm Type X gypsum board 	1 h	35	27
	Column 1	2	3	4	5

Table 2 (Cont'd)
Fire and Sound Resistance of Floors, Ceilings and Roofs⁽¹⁾

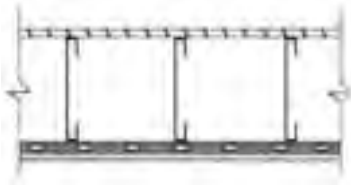
Type of Assembly	Assembly Number	Description ⁽²⁾⁽³⁾⁽⁴⁾	Fire-Resistance Rating ⁽⁵⁾⁽⁶⁾⁽⁷⁾⁽⁸⁾	Typical Sound Transmission Class ⁽⁵⁾⁽⁶⁾⁽⁹⁾⁽¹⁰⁾ (STC)	Typical Impact Insulation Class ⁽⁵⁾⁽⁹⁾⁽¹¹⁾ (IIC)
Floors and Ceilings					
Cold Formed Steel Floor Joists ⁽²⁶⁾	F43d	F43 with <ul style="list-style-type: none"> • absorptive material in cavity • 12.7 mm Type X gypsum board • resilient metal channels • 12.7 mm Type X gypsum board 	1 h	37	30
	F43e	F43 with <ul style="list-style-type: none"> • no absorptive material in cavity • 12.7 mm regular gypsum board • resilient metal channels • 12.7 mm regular gypsum board 	—	32	26
	F43f	F43 with <ul style="list-style-type: none"> • absorptive material in cavity • 12.7 mm regular gypsum board • resilient metal channels • 12.7 mm regular gypsum board 	—	35	28
	F44	<ul style="list-style-type: none"> • subfloor of 15.5 mm plywood, OSB or waferboard, or 17 mm tongue and groove lumber • on steel joists spaced not more than 610 mm o.c. • with or without absorptive material in cavity • resilient metal channels spaced 406 mm or 610 mm o.c. • 1 layer of gypsum board on ceiling side 			
	F44a	F44 with <ul style="list-style-type: none"> • no absorptive material in cavity • resilient metal channels spaced 406 mm o.c. • 15.9 mm Type X gypsum board 	—	40	33
	F44b	F44 with <ul style="list-style-type: none"> • no absorptive material in cavity • resilient metal channels spaced 610 mm o.c. • 15.9 mm Type X gypsum board 	—	43	36
	F44c	F44 with <ul style="list-style-type: none"> • absorptive material in cavity • resilient metal channels spaced 406 mm o.c. • 15.9 mm Type X gypsum board 	30 min [45 min] ⁽²⁴⁾	47	41
	F44d	F44 with <ul style="list-style-type: none"> • absorptive material in cavity • resilient metal channels spaced 610 mm o.c. • 15.9 mm Type X gypsum board 	30 min	50	44
	Column 1	2	3	4	5

Table 2 (Cont'd)
Fire and Sound Resistance of Floors, Ceilings and Roofs⁽¹⁾

Type of Assembly	Assembly Number	Description ⁽²⁾⁽³⁾⁽⁴⁾	Fire-Resistance Rating ⁽⁵⁾⁽⁶⁾⁽⁷⁾⁽⁸⁾	Typical Sound Transmission Class ⁽⁵⁾⁽⁶⁾⁽⁹⁾⁽¹⁰⁾ (STC)	Typical Impact Insulation Class ⁽⁵⁾⁽⁹⁾⁽¹¹⁾ (IIC)
Floors and Ceilings					
Cold Formed Steel Floor Joists ⁽²⁶⁾	F44e	F44 with <ul style="list-style-type: none"> • no absorptive material in cavity • resilient metal channels spaced 406 mm o.c. • 12.7 mm Type X gypsum board 	—	39	32
	F44f	F44 with <ul style="list-style-type: none"> • no absorptive material in cavity • resilient metal channels spaced 610 mm o.c. • 12.7 mm Type X gypsum board 	—	41	35
	F44g	F44 with <ul style="list-style-type: none"> • absorptive material in cavity • resilient metal channels spaced 406 mm o.c. • 12.7 mm Type X gypsum board 	30 min [45 min] ⁽²⁴⁾	46	40
	F44h	F44 with <ul style="list-style-type: none"> • absorptive material in cavity • resilient metal channels spaced 610 mm o.c. • 12.7 mm Type X gypsum board 	30 min	48	43
	F44i	F44 with <ul style="list-style-type: none"> • no absorptive material in cavity • resilient metal channels spaced 406 mm o.c. • 12.7 regular gypsum board 	< 30 min	38	31
	F44j	F44 with <ul style="list-style-type: none"> • no absorptive material in cavity • resilient metal channels spaced 610 mm o.c. • 12.7 regular gypsum board 	< 30 min	41	34
	F44k	F44 with <ul style="list-style-type: none"> • absorptive material in cavity • resilient metal channels spaced 406 mm o.c. • 12.7 regular gypsum board 	< 30 min	45	39
	F44l	F44 with <ul style="list-style-type: none"> • absorptive material in cavity • resilient metal channels spaced 610 mm o.c. • 12.7 regular gypsum board 	< 30 min	48	42
	F45	<ul style="list-style-type: none"> • subfloor of 15.5 mm plywood, OSB or waferboard, or 17 mm tongue and groove lumber • on steel joists spaced not more than 610 mm o.c. • with or without absorptive material in cavity • resilient metal channels spaced 406 mm or 610 mm o.c. • 2 layers of gypsum board on ceiling side 			
Column 1	2	3	4	5	6

Table 2 (Cont'd)
Fire and Sound Resistance of Floors, Ceilings and Roofs⁽¹⁾

Type of Assembly	Assembly Number	Description ⁽²⁾⁽³⁾⁽⁴⁾	Fire-Resistance Rating ⁽⁵⁾⁽⁶⁾⁽⁷⁾⁽⁸⁾	Typical Sound Transmission Class ⁽⁵⁾⁽⁶⁾⁽⁹⁾⁽¹⁰⁾ (STC)	Typical Impact Insulation Class ⁽⁵⁾⁽⁹⁾⁽¹¹⁾ (IIC)
Floors and Ceilings					
Cold Formed Steel Floor Joists ⁽²⁶⁾	F45a	F45 with <ul style="list-style-type: none"> • no absorptive material in cavity • resilient metal channels spaced 406 mm o.c. • 15.9 mm Type X gypsum board 	1 h	45	38
	F45b	F45 with <ul style="list-style-type: none"> • steel joists spaced 406 mm • no absorptive material in cavity • resilient metal channels spaced 610 mm o.c. • 15.9 mm Type X gypsum board 	45 min	48	40
	F45c	F45 with <ul style="list-style-type: none"> • steel joists spaced 610 mm • no absorptive material in cavity • resilient metal channels spaced 610 mm o.c. • 15.9 mm Type X gypsum board 	45 min	49	40
	F45d	F45 with <ul style="list-style-type: none"> • absorptive material in cavity • resilient metal channels spaced 406 mm o.c. • 15.9 mm Type X gypsum board 	1 h	52	46
	F45e	F45 with <ul style="list-style-type: none"> • steel joists spaced 406 mm • absorptive material in cavity • resilient metal channels spaced 610 mm o.c. • 15.9 mm Type X gypsum board 	45 min [1 h] ⁽²⁷⁾	55	48
	F45f	F45 with <ul style="list-style-type: none"> • steel joists spaced 610 mm • absorptive material in cavity • resilient metal channels spaced 610 mm o.c. • 15.9 mm Type X gypsum board 	45 min [1 h] ⁽¹⁴⁾	56	48
	F45g	F45 with <ul style="list-style-type: none"> • no absorptive material in cavity • resilient metal channels spaced 406 mm o.c. • 12.7 mm Type X gypsum board 	1 h	44	36
	F45h	F45 with <ul style="list-style-type: none"> • steel joists spaced 406 mm • no absorptive material in cavity • resilient metal channels spaced 610 mm o.c. • 12.7 mm Type X gypsum board 	45 min	46	39
Column 1	2	3	4	5	6

Table 2 (Cont'd)
Fire and Sound Resistance of Floors, Ceilings and Roofs⁽¹⁾

Type of Assembly	Assembly Number	Description ⁽²⁾⁽³⁾⁽⁴⁾	Fire-Resistance Rating ⁽⁵⁾⁽⁶⁾⁽⁷⁾⁽⁸⁾	Typical Sound Transmission Class ⁽⁵⁾⁽⁶⁾⁽⁹⁾⁽¹⁰⁾ (STC)	Typical Impact Insulation Class ⁽⁵⁾⁽⁹⁾⁽¹¹⁾ (IIC)
Floors and Ceilings					
Cold Formed Steel Floor Joists ⁽²⁶⁾	F45i	F45 with <ul style="list-style-type: none"> • steel joists spaced 610 mm • no absorptive material in cavity • resilient metal channels spaced 610 mm o.c. • 12.7 mm Type X gypsum board 	45 min	47	39
	F45j	F45 with <ul style="list-style-type: none"> • absorptive material in cavity • resilient metal channels spaced 406 mm o.c. • 12.7 mm Type X gypsum board 	1 h	51	44
	F45k	F45 with <ul style="list-style-type: none"> • steel joists spaced 406 mm o.c. • absorptive material in cavity • resilient metal channels spaced 610 mm o.c. • 12.7 mm Type X gypsum board 	45 min [1 h] ⁽²⁷⁾	53	47
	F45l	F45 with <ul style="list-style-type: none"> • steel joists spaced 610 mm • absorptive material in cavity • resilient metal channels spaced 610 mm o.c. • 12.7 mm Type X gypsum board 	45 min [1 h] ⁽¹⁴⁾	54	47
	F45m	F45 with <ul style="list-style-type: none"> • no absorptive material in cavity • resilient metal channels spaced 406 mm o.c. • 12.7 mm regular gypsum board 	—	43	36
	F45n	F45 with <ul style="list-style-type: none"> • no absorptive material in cavity • resilient metal channels spaced 610 mm o.c. • 12.7 mm regular gypsum board 	—	45	39
	F45o	F45 with <ul style="list-style-type: none"> • absorptive material in cavity • resilient metal channels spaced 406 mm o.c. • 12.7 mm regular gypsum board 	—	50	44
	F45p	F45 with <ul style="list-style-type: none"> • absorptive material in cavity • resilient metal channels spaced 610 mm o.c. • 12.7 mm regular gypsum board 	—	52	47
	Column 1	2	3	4	5

Table 2 (Cont'd)
Fire and Sound Resistance of Floors, Ceilings and Roofs⁽¹⁾

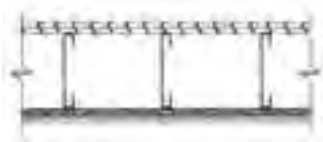
Type of Assembly	Assembly Number	Description ⁽²⁾⁽³⁾⁽⁴⁾	Fire-Resistance Rating ⁽⁵⁾⁽⁶⁾⁽⁷⁾⁽⁸⁾	Typical Sound Transmission Class ⁽⁵⁾⁽⁶⁾⁽⁹⁾⁽¹⁰⁾ (STC)	Typical Impact Insulation Class ⁽⁵⁾⁽⁹⁾⁽¹¹⁾ (IIC)
Floors and Ceilings					
Cold Formed Steel Floor Joists ⁽²⁶⁾	F46	<ul style="list-style-type: none"> one subfloor layer of 11 mm sanded plywood, or OSB or waferboard one subfloor layer of 15.5 mm plywood, OSB or waferboard, or 17 mm tongue and groove lumber on steel joists spaced not more than 610 mm o.c. with or without absorptive material in cavity resilient metal channels spaced 406 mm or 610 mm o.c. 1 layer of gypsum board on ceiling side 			
	F46a	F46 with <ul style="list-style-type: none"> no absorptive material in cavity resilient metal channels spaced 406 mm o.c. 15.9 mm Type X gypsum board 	—	43	34
	F46b	F46 with <ul style="list-style-type: none"> no absorptive material in cavity resilient metal channels spaced 610 mm o.c. 15.9 mm Type X gypsum board 	—	46	37
	F46c	F46 with <ul style="list-style-type: none"> absorptive material in cavity resilient metal channels spaced 406 mm o.c. 15.9 mm Type X gypsum board 	—	50	42
	F46d	F46 with <ul style="list-style-type: none"> absorptive material in cavity resilient metal channels spaced 610 mm o.c. 15.9 mm Type X gypsum board 	—	53	45
	F46e	F46 with <ul style="list-style-type: none"> no absorptive material in cavity resilient metal channels spaced 406 mm o.c. 12.7 mm Type X gypsum board 	—	42	33
	F46f	F46 with <ul style="list-style-type: none"> no absorptive material in cavity resilient metal channels spaced 610 mm o.c. 12.7 mm Type X gypsum board 	—	44	36
	F46g	F46 with <ul style="list-style-type: none"> absorptive material in cavity resilient metal channels spaced 406 mm o.c. 12.7 mm Type X gypsum board 	—	49	41
	F46h	F46 with <ul style="list-style-type: none"> absorptive material in cavity resilient metal channels spaced 610 mm o.c. 12.7 mm Type X gypsum board 	—	51	44
Column 1	2	3	4	5	6

Table 2 (Cont'd)
Fire and Sound Resistance of Floors, Ceilings and Roofs⁽¹⁾

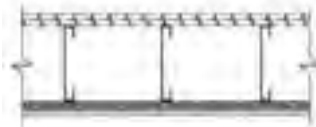
Type of Assembly	Assembly Number	Description ⁽²⁾⁽³⁾⁽⁴⁾	Fire-Resistance Rating ⁽⁵⁾⁽⁶⁾⁽⁷⁾⁽⁸⁾	Typical Sound Transmission Class ⁽⁵⁾⁽⁶⁾⁽⁹⁾⁽¹⁰⁾ (STC)	Typical Impact Insulation Class ⁽⁵⁾⁽⁹⁾⁽¹¹⁾ (IIC)
Floors and Ceilings					
Cold Formed Steel Floor Joists ⁽²⁶⁾	F46i	F46 with <ul style="list-style-type: none"> • no absorptive material in cavity • resilient metal channels spaced 406 mm o.c. • 12.7 mm regular gypsum board 	—	41	33
	F46j	F46 with <ul style="list-style-type: none"> • no absorptive material in cavity • resilient metal channels spaced 610 mm o.c. • 12.7 mm regular gypsum board 	—	44	36
	F46k	F46 with <ul style="list-style-type: none"> • absorptive material in cavity • resilient metal channels spaced 406 mm o.c. • 12.7 mm regular gypsum board 	—	48	41
	F46l	F46 with <ul style="list-style-type: none"> • absorptive material in cavity • resilient metal channels spaced 610 mm o.c. • 12.7 mm regular gypsum board 	—	51	44
	F47	<ul style="list-style-type: none"> • one subfloor layer of 15.5 mm plywood or OSB or waferboard • one subfloor layer of 15.5 mm plywood, OSB or waferboard, or 17 mm tongue and groove lumber • on steel joists spaced not more than 406 mm o.c. • with or without absorptive material in cavity • resilient metal channels spaced 406 mm or 610 mm o.c. • 1 layer of gypsum board on ceiling side 			
	F47a	F47 with <ul style="list-style-type: none"> • no absorptive material in cavity • resilient metal channels spaced 406 mm o.c. • 15.9 mm Type X gypsum board 	30 min	45	35
	F47b	F47 with <ul style="list-style-type: none"> • no absorptive material in cavity • resilient metal channels spaced 610 mm o.c. • 15.9 mm Type X gypsum board 	30 min	47	38
	F47c	F47 with <ul style="list-style-type: none"> • absorptive material in cavity • resilient metal channels spaced 406 mm o.c. • 15.9 mm Type X gypsum board 	30 min [45 min] ⁽¹⁷⁾ [1 h] ⁽²⁷⁾	51	45
	F47d	F47 with <ul style="list-style-type: none"> • absorptive material in cavity • resilient metal channels spaced 610 mm o.c. • 15.9 mm Type X gypsum board 	[30 min] ⁽¹⁷⁾ [45 min] ⁽²⁷⁾	53	47
	Column 1	2	3	4	5

Table 2 (Cont'd)
Fire and Sound Resistance of Floors, Ceilings and Roofs⁽¹⁾


Type of Assembly	Assembly Number	Description ⁽²⁾⁽³⁾⁽⁴⁾	Fire-Resistance Rating ⁽⁵⁾⁽⁶⁾⁽⁷⁾⁽⁸⁾	Typical Sound Transmission Class ⁽⁵⁾⁽⁶⁾⁽⁹⁾⁽¹⁰⁾ (STC)	Typical Impact Insulation Class ⁽⁵⁾⁽⁹⁾⁽¹¹⁾ (IIC)
Floors and Ceilings					
Cold Formed Steel Floor Joists ⁽²⁶⁾	F47e	F47 with <ul style="list-style-type: none"> • no absorptive material in cavity • resilient metal channels spaced 406 mm o.c. • 12.7 mm Type X gypsum board 	30 min	43	44
	F47f	F47 with <ul style="list-style-type: none"> • no absorptive material in cavity • resilient metal channels spaced 610 mm o.c. • 12.7 mm Type X gypsum board 	—	45	47
	F47g	F47 with <ul style="list-style-type: none"> • absorptive material in cavity • resilient metal channels spaced 406 mm o.c. • 12.7 mm Type X gypsum board 	[30 min] ⁽¹⁷⁾ [45 min] ⁽²⁷⁾	50	43
	F47h	F47 with <ul style="list-style-type: none"> • absorptive material in cavity • resilient metal channels spaced 610 mm o.c. • 12.7 mm Type X gypsum board 	—	52	46
	F48	<ul style="list-style-type: none"> • one subfloor layer of 11 mm sanded plywood, or OSB or waferboard • one subfloor layer of 15.5 mm plywood, OSB or waferboard, or 17 mm tongue and groove lumber • on steel joists spaced not more than 610 mm o.c. • with or without absorptive material in cavity • resilient metal channels spaced 406 mm or 610 mm o.c. • 2 layers of gypsum board on ceiling side 			
	F48a	F48 with <ul style="list-style-type: none"> • no absorptive material in cavity • resilient metal channels spaced 406 mm o.c. • 15.9 mm Type X gypsum board 	1 h	48	39
	F48b	F48 with <ul style="list-style-type: none"> • no absorptive material in cavity • resilient metal channels spaced 610 mm o.c. • 15.9 mm Type X gypsum board 	1 h	50	42
	F48c	F48 with <ul style="list-style-type: none"> • absorptive material in cavity • resilient metal channels spaced 406 mm o.c. • 15.9 mm Type X gypsum board 	1 h	56	47
	F48d	F48 with <ul style="list-style-type: none"> • absorptive material in cavity • resilient metal channels spaced 610 mm o.c. • 15.9 mm Type X gypsum board 	1 h	57	50
	Column 1	2	3	4	5

Table 2 (Cont'd)
Fire and Sound Resistance of Floors, Ceilings and Roofs⁽¹⁾

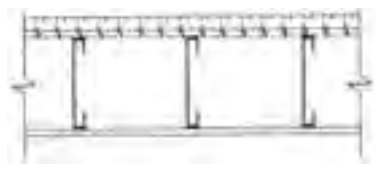
Type of Assembly	Assembly Number	Description ⁽²⁾⁽³⁾⁽⁴⁾	Fire-Resistance Rating ⁽⁵⁾⁽⁶⁾⁽⁷⁾⁽⁸⁾	Typical Sound Transmission Class ⁽⁵⁾⁽⁶⁾⁽⁹⁾⁽¹⁰⁾ (STC)	Typical Impact Insulation Class ⁽⁵⁾⁽⁹⁾⁽¹¹⁾ (IIC)
Floors and Ceilings					
Cold Formed Steel Floor Joists ⁽²⁶⁾	F48e	F48 with <ul style="list-style-type: none"> • no absorptive material in cavity • resilient metal channels spaced 406 mm o.c. • 12.7 mm Type X gypsum board 	1 h	47	38
	F48f	F48 with <ul style="list-style-type: none"> • no absorptive material in cavity • resilient metal channels spaced 610 mm o.c. • 12.7 mm Type X gypsum board 	—	49	40
	F48g	F48 with <ul style="list-style-type: none"> • absorptive material in cavity • resilient metal channels spaced 406 mm o.c. • 12.7 mm Type X gypsum board 	1 h	54	46
	F48h	F48 with <ul style="list-style-type: none"> • absorptive material in cavity • resilient metal channels spaced 610 mm o.c. • 12.7 mm Type X gypsum board 	—	56	48
	F48i	F48 with <ul style="list-style-type: none"> • no absorptive material in cavity • resilient metal channels spaced 406 mm o.c. • 12.7 mm regular gypsum board 	—	46	37
	F48j	F48 with <ul style="list-style-type: none"> • no absorptive material in cavity • resilient metal channels spaced 610 mm o.c. • 12.7 mm regular gypsum board 	—	48	40
	F48k	F48 with <ul style="list-style-type: none"> • absorptive material in cavity • resilient metal channels spaced 406 mm o.c. • 12.7 mm regular gypsum board 	—	53	45
	F48l	F48 with <ul style="list-style-type: none"> • absorptive material in cavity • resilient metal channels spaced 610 mm o.c. • 12.7 mm regular gypsum board 	—	55	48
	F49	<ul style="list-style-type: none"> • 25 mm gypsum-concrete topping (at least 44 kg/m²) • subfloor of 15.5 mm plywood, OSB or waferboard, or 17 mm tongue and groove lumber • on steel joists spaced not more than 610 mm o.c. • with or without absorptive material in cavity • 1 layer of gypsum board on ceiling side 			
Column 1	2	3	4	5	6

Table 2 (Cont'd)
Fire and Sound Resistance of Floors, Ceilings and Roofs⁽¹⁾

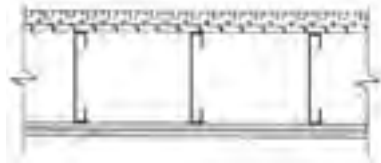
Type of Assembly	Assembly Number	Description ⁽²⁾⁽³⁾⁽⁴⁾	Fire-Resistance Rating ⁽⁵⁾⁽⁶⁾⁽⁷⁾⁽⁸⁾	Typical Sound Transmission Class ⁽⁵⁾⁽⁶⁾⁽⁹⁾⁽¹⁰⁾ (STC)	Typical Impact Insulation Class ⁽⁵⁾⁽⁹⁾⁽¹¹⁾ (IIC)	
Floors and Ceilings						
Cold Formed Steel Floor Joists ⁽²⁶⁾	F49a	F49 with <ul style="list-style-type: none"> • no absorptive material in cavity • 15.9 mm Type X gypsum board 	—	40	13	
	F49b	F49 with <ul style="list-style-type: none"> • absorptive material in cavity • 15.9 mm Type X gypsum board 	—	42	16	
	F49c	F49 with <ul style="list-style-type: none"> • no absorptive material in cavity • 12.7 mm Type X gypsum board 	—	39	12	
	F49d	F49 with <ul style="list-style-type: none"> • absorptive material in cavity • 12.7 mm Type X gypsum board 	—	41	15	
	F49e	F49 with <ul style="list-style-type: none"> • no absorptive material in cavity • 12.7 mm regular gypsum board 	—	38	12	
	F49f	F49 with <ul style="list-style-type: none"> • absorptive material in cavity • 12.7 mm regular gypsum board 	—	40	15	
	F50	<ul style="list-style-type: none"> • 25 mm gypsum-concrete topping (at least 44 kg/m²) • subfloor of 15.5 mm plywood, OSB or waferboard, or 17 mm tongue and groove lumber • on steel joists spaced not more than 610 mm o.c. • with or without absorptive material in cavity • 2 layers of gypsum board on ceiling side 				
	F50a	F50 with <ul style="list-style-type: none"> • no absorptive material in cavity • 15.9 mm Type X gypsum board 	—	45	16	
	F50b	F50 with <ul style="list-style-type: none"> • absorptive material in cavity • 15.9 mm Type X gypsum board 	—	47	19	
	F50c	F50 with <ul style="list-style-type: none"> • no absorptive material in cavity • 12.7 mm Type X gypsum board 	—	44	15	
	F50d	F50 with <ul style="list-style-type: none"> • absorptive material in cavity • 12.7 mm Type X gypsum board 	—	46	18	
	Column 1	2	3	4	5	6

Table 2 (Cont'd)
Fire and Sound Resistance of Floors, Ceilings and Roofs⁽¹⁾


Type of Assembly	Assembly Number	Description ⁽²⁾⁽³⁾⁽⁴⁾	Fire-Resistance Rating ⁽⁵⁾⁽⁶⁾⁽⁷⁾⁽⁸⁾	Typical Sound Transmission Class ⁽⁵⁾⁽⁶⁾⁽⁹⁾⁽¹⁰⁾ (STC)	Typical Impact Insulation Class ⁽⁵⁾⁽⁹⁾⁽¹¹⁾ (IIC)
Floors and Ceilings					
Cold Formed Steel Floor Joists ⁽²⁶⁾	F50e	F50 with <ul style="list-style-type: none"> • no absorptive material in cavity • 12.7 mm regular gypsum board 	—	43	14
	F50f	F50 with <ul style="list-style-type: none"> • absorptive material in cavity • 12.7 mm regular gypsum board 	—	45	17
	F51	<ul style="list-style-type: none"> • 25 mm gypsum-concrete topping (at least 44 kg/m²) • subfloor of 15.5 mm plywood, OSB or waferboard, or 17 mm tongue and groove lumber • on steel joists spaced not more than 610 mm o.c. • with or without absorptive material in cavity • resilient metal channels spaced 406 mm or 610 mm o.c. • 1 layer of gypsum board on ceiling side 			
	F51a	F51 with <ul style="list-style-type: none"> • no absorptive material in cavity • resilient metal channels spaced 406 mm o.c. • 15.9 mm Type X gypsum board 	—	52	22
	F51b	F51 with <ul style="list-style-type: none"> • no absorptive material in cavity • resilient metal channels spaced 610 mm o.c. • 15.9 mm Type X gypsum board 	—	54	22
	F51c	F51 with <ul style="list-style-type: none"> • absorptive material in cavity • resilient metal channels spaced 406 mm o.c. • 15.9 mm Type X gypsum board 	—	59	30
	F51d	F51 with <ul style="list-style-type: none"> • absorptive material in cavity • resilient metal channels spaced 610 mm o.c. • 15.9 mm Type X gypsum board 	—	61	30
	F51e	F51 with <ul style="list-style-type: none"> • no absorptive material in cavity • resilient metal channels spaced 406 mm o.c. • 12.7 mm Type X gypsum board 	—	51	21
	F51f	F51 with <ul style="list-style-type: none"> • no absorptive material in cavity • resilient metal channels spaced 610 mm o.c. • 12.7 mm Type X gypsum board 	—	53	21
	Column 1	2	3	4	5

Table 2 (Cont'd)
Fire and Sound Resistance of Floors, Ceilings and Roofs⁽¹⁾


Type of Assembly	Assembly Number	Description ⁽²⁾⁽³⁾⁽⁴⁾	Fire-Resistance Rating ⁽⁵⁾⁽⁶⁾⁽⁷⁾⁽⁸⁾	Typical Sound Transmission Class ⁽⁵⁾⁽⁶⁾⁽⁹⁾⁽¹⁰⁾ (STC)	Typical Impact Insulation Class ⁽⁵⁾⁽⁹⁾⁽¹¹⁾ (IIC)
Floors and Ceilings					
Cold Formed Steel Floor Joists ⁽²⁶⁾	F51g	F51 with <ul style="list-style-type: none"> • absorptive material in cavity • resilient metal channels spaced 406 mm o.c. • 12.7 mm Type X gypsum board 	—	58	29
	F51h	F51 with <ul style="list-style-type: none"> • absorptive material in cavity • resilient metal channels spaced 610 mm o.c. • 12.7 mm Type X gypsum board 	—	60	29
	F51i	F51 with <ul style="list-style-type: none"> • no absorptive material in cavity • resilient metal channels spaced 406 mm o.c. • 12.7 mm regular gypsum board 	—	50	21
	F51j	F51 with <ul style="list-style-type: none"> • no absorptive material in cavity • resilient metal channels spaced 610 mm o.c. • 12.7 mm regular gypsum board 	—	52	21
	F51k	F51 with <ul style="list-style-type: none"> • absorptive material in cavity • resilient metal channels spaced 406 mm o.c. • 12.7 mm regular gypsum board 	—	57	29
	F51l	F51 with <ul style="list-style-type: none"> • absorptive material in cavity • resilient metal channels spaced 610 mm o.c. • 12.7 mm regular gypsum board 	—	59	29
	F52	<ul style="list-style-type: none"> • 25 mm gypsum-concrete topping (at least 44 kg/m²) • subfloor of 15.5 mm plywood, OSB or waferboard, or 17 mm tongue and groove lumber • on steel joists spaced not more than 610 mm o.c. • with or without absorptive material in cavity • resilient metal channels spaced 406 mm or 610 mm o.c. • 2 layers of gypsum board on ceiling side 			
	F52a	F52 with <ul style="list-style-type: none"> • no absorptive material in cavity • resilient metal channels spaced 406 mm o.c. • 15.9 mm Type X gypsum board 	1 h	57	25
	F52b	F52 with <ul style="list-style-type: none"> • no absorptive material in cavity • resilient metal channels spaced 610 mm o.c. • 15.9 mm Type X gypsum board 	1 h	59	25
	Column 1	2	3	4	5

Table 2 (Cont'd)
Fire and Sound Resistance of Floors, Ceilings and Roofs⁽¹⁾

Type of Assembly	Assembly Number	Description ⁽²⁾⁽³⁾⁽⁴⁾	Fire-Resistance Rating ⁽⁵⁾⁽⁶⁾⁽⁷⁾⁽⁸⁾	Typical Sound Transmission Class ⁽⁵⁾⁽⁶⁾⁽⁹⁾⁽¹⁰⁾ (STC)	Typical Impact Insulation Class ⁽⁵⁾⁽⁹⁾⁽¹¹⁾ (IIC)
Floors and Ceilings					
Cold Formed Steel Floor Joists ⁽²⁵⁾	F52c	F52 with <ul style="list-style-type: none"> • absorptive material in cavity • resilient metal channels spaced 406 mm o.c. • 15.9 mm Type X gypsum board 	1 h	64	33
	F52d	F52 with <ul style="list-style-type: none"> • absorptive material in cavity • resilient metal channels spaced 610 mm o.c. • 15.9 mm Type X gypsum board 	45 min [1 h] ⁽²⁴⁾	66	33
	F52e	F52 with <ul style="list-style-type: none"> • no absorptive material in cavity • resilient metal channels spaced 406 mm o.c. • 12.7 mm Type X gypsum board 	1 h	55	24
	F52f	F52 with <ul style="list-style-type: none"> • no absorptive material in cavity • resilient metal channels spaced 610 mm o.c. • 12.7 mm Type X gypsum board 	1 h	58	24
	F52g	F52 with <ul style="list-style-type: none"> • absorptive material in cavity • resilient metal channels spaced 406 mm o.c. • 12.7 mm Type X gypsum board 	1 h	62	32
	F52h	F52 with <ul style="list-style-type: none"> • absorptive material in cavity • resilient metal channels spaced 610 mm o.c. • 12.7 mm Type X gypsum board 	45 min [1 h] ⁽²⁴⁾	65	32
	F52i	F52 with <ul style="list-style-type: none"> • no absorptive material in cavity • resilient metal channels spaced 406 mm o.c. • 12.7 mm regular gypsum board 	—	55	23
	F52j	F52 with <ul style="list-style-type: none"> • no absorptive material in cavity • resilient metal channels spaced 610 mm o.c. • 12.7 mm regular gypsum board 	—	57	23
	F52k	F52 with <ul style="list-style-type: none"> • absorptive material in cavity • resilient metal channels spaced 406 mm o.c. • 12.7 mm regular gypsum board 	—	62	31
	F52l	F52 with <ul style="list-style-type: none"> • absorptive material in cavity • resilient metal channels spaced 610 mm o.c. • 12.7 mm regular gypsum board 	—	64	31
Column 1	2	3	4	5	6

Table 2 (Cont'd)
Fire and Sound Resistance of Floors, Ceilings and Roofs⁽¹⁾

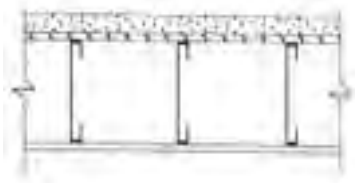
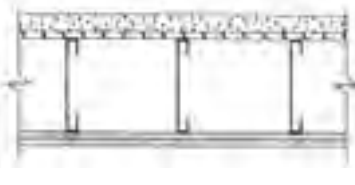
Type of Assembly	Assembly Number	Description ⁽²⁾⁽³⁾⁽⁴⁾	Fire-Resistance Rating ⁽⁵⁾⁽⁶⁾⁽⁷⁾⁽⁸⁾	Typical Sound Transmission Class ⁽⁵⁾⁽⁶⁾⁽⁹⁾⁽¹⁰⁾ (STC)	Typical Impact Insulation Class ⁽⁵⁾⁽⁹⁾⁽¹¹⁾ (IIC)
Floors and Ceilings					
Cold Formed Steel Floor Joists ⁽²⁶⁾	F53	<ul style="list-style-type: none"> • 38 mm concrete topping (at least 70 kg/m²) • subfloor of 12.5 mm plywood, OSB or waferboard, or 17 mm tongue and groove lumber • on steel joists spaced not more than 610 mm o.c. • 1 layer of gypsum board on ceiling side 			
	F53a	F53 with <ul style="list-style-type: none"> • no absorptive material in cavity • 15.9 mm Type X gypsum board 	—	44	22
	F53b	F53 with <ul style="list-style-type: none"> • absorptive material in cavity • 15.9 mm Type X gypsum board 	—	46	25
	F53c	F53 with <ul style="list-style-type: none"> • no absorptive material in cavity • 12.7 mm Type X gypsum board 	—	42	21
	F53d	F53 with <ul style="list-style-type: none"> • absorptive material in cavity • 12.7 mm Type X gypsum board 	—	44	24
	F53e	F53 with <ul style="list-style-type: none"> • no absorptive material in cavity • 12.7 mm regular gypsum board 	—	42	21
	F53f	F53 with <ul style="list-style-type: none"> • absorptive material in cavity • 12.7 mm regular gypsum board 	—	44	24
	F54	<ul style="list-style-type: none"> • 38 mm concrete topping (at least 70 kg/m²) • subfloor of 15.5 mm plywood, OSB or waferboard, or 17 mm tongue and groove lumber • on steel joists spaced not more than 610 mm o.c. • 2 layers of gypsum board on ceiling side 			
	F54a	F54 with <ul style="list-style-type: none"> • no absorptive material in cavity • 15.9 mm Type X gypsum board 	—	48	24
	F54b	F54 with <ul style="list-style-type: none"> • absorptive material in cavity • 15.9 mm Type X gypsum board 	—	50	27
	Column 1	2	3	4	5

Table 2 (Cont'd)
Fire and Sound Resistance of Floors, Ceilings and Roofs⁽¹⁾

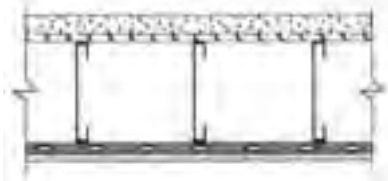
Type of Assembly	Assembly Number	Description ⁽²⁾⁽³⁾⁽⁴⁾	Fire-Resistance Rating ⁽⁵⁾⁽⁶⁾⁽⁷⁾⁽⁸⁾	Typical Sound Transmission Class ⁽⁵⁾⁽⁶⁾⁽⁹⁾⁽¹⁰⁾ (STC)	Typical Impact Insulation Class ⁽⁵⁾⁽⁹⁾⁽¹¹⁾ (IIC)	
Floors and Ceilings						
Cold Formed Steel Floor Joists ⁽²⁶⁾	F54c	F54 with <ul style="list-style-type: none"> • no absorptive material in cavity • 12.7 mm Type X gypsum board 	—	47	23	
	F54d	F54 with <ul style="list-style-type: none"> • absorptive material in cavity • 12.7 mm Type X gypsum board 	—	49	26	
	F54e	F54 with <ul style="list-style-type: none"> • no absorptive material in cavity • 12.7 mm regular gypsum board 	—	47	23	
	F54f	F54 with <ul style="list-style-type: none"> • absorptive material in cavity • 12.7 mm regular gypsum board 	—	49	26	
	F55	<ul style="list-style-type: none"> • 38 mm concrete topping (at least 70 kg/m²) • subfloor of 15.5 mm plywood, OSB or waferboard, or 17 mm tongue and groove lumber • on steel joists spaced not more than 610 mm o.c. • with or without absorptive material in cavity • resilient metal channels spaced 406 mm or 610 mm o.c. • 1 layer of gypsum board on ceiling side 				
	F55a	F55 with <ul style="list-style-type: none"> • no absorptive material in cavity • resilient metal channels spaced 406 mm o.c. • 15.9 mm Type X gypsum board 	—	56	31	
	F55b	F55 with <ul style="list-style-type: none"> • no absorptive material in cavity • resilient metal channels spaced 610 mm o.c. • 15.9 mm Type X gypsum board 	—	58	31	
	F55c	F55 with <ul style="list-style-type: none"> • absorptive material in cavity • resilient metal channels spaced 406 mm o.c. • 15.9 mm Type X gypsum board 	—	63	39	
	F55d	F55 with <ul style="list-style-type: none"> • absorptive material in cavity • resilient metal channels spaced 610 mm o.c. • 15.9 mm Type X gypsum board 	—	65	39	
	F55e	F55 with <ul style="list-style-type: none"> • no absorptive material in cavity • resilient metal channels spaced 406 mm o.c. • 12.7 mm Type X gypsum board 	—	54	30	
	F55f	F55 with <ul style="list-style-type: none"> • no absorptive material in cavity • resilient metal channels spaced 610 mm o.c. • 12.7 mm Type X gypsum board 	—	56	30	
	Column 1	2	3	4	5	6

Table 2 (Cont'd)
Fire and Sound Resistance of Floors, Ceilings and Roofs⁽¹⁾

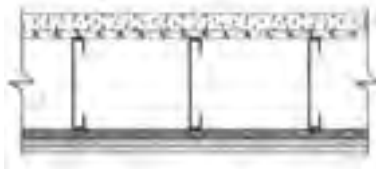
Type of Assembly	Assembly Number	Description ⁽²⁾⁽³⁾⁽⁴⁾	Fire-Resistance Rating ⁽⁵⁾⁽⁶⁾⁽⁷⁾⁽⁸⁾	Typical Sound Transmission Class ⁽⁵⁾⁽⁶⁾⁽⁹⁾⁽¹⁰⁾ (STC)	Typical Impact Insulation Class ⁽⁵⁾⁽⁹⁾⁽¹¹⁾ (IIC)
Floors and Ceilings					
Cold Formed Steel Floor Joists ⁽²⁶⁾	F55g	F55 with <ul style="list-style-type: none"> • absorptive material in cavity • resilient metal channels spaced 406 mm o.c. • 12.7 mm Type X gypsum board 	—	61	38
	F55h	F55 with <ul style="list-style-type: none"> • absorptive material in cavity • resilient metal channels spaced 610 mm o.c. • 12.7 mm Type X gypsum board 	—	63	38
	F55i	F55 with <ul style="list-style-type: none"> • no absorptive material in cavity • resilient metal channels spaced 406 mm o.c. • 12.7 mm regular gypsum board 	—	54	30
	F55j	F55 with <ul style="list-style-type: none"> • no absorptive material in cavity • resilient metal channels spaced 610 mm o.c. • 12.7 mm regular gypsum board 	—	56	30
	F55k	F55 with <ul style="list-style-type: none"> • absorptive material in cavity • resilient metal channels spaced 406 mm o.c. • 12.7 mm regular gypsum board 	—	61	38
	F55l	F55 with <ul style="list-style-type: none"> • absorptive material in cavity • resilient metal channels spaced 610 mm o.c. • 12.7 mm regular gypsum board 	—	63	38
	F56	<ul style="list-style-type: none"> • 38 mm concrete topping (at least 70 kg/m²) • subfloor of 15.5 mm plywood, OSB or waferboard, or 17 mm tongue and groove lumber • on steel joists spaced not more than 610 mm o.c. • with or without absorptive material in cavity • resilient metal channels spaced 406 mm or 610 mm o.c. • 2 layers of gypsum board on ceiling side 			
	56a	F56 with <ul style="list-style-type: none"> • no absorptive material in cavity • resilient metal channels spaced 406 mm o.c. • 15.9 mm Type X gypsum board 	1 h	60	33
	56b	F56 with <ul style="list-style-type: none"> • no absorptive material in cavity • resilient metal channels spaced 610 mm o.c. • 15.9 mm Type X gypsum board 	1 h	62	33
	Column 1	2	3	4	5

Table 2 (Cont'd)
Fire and Sound Resistance of Floors, Ceilings and Roofs⁽¹⁾

Type of Assembly	Assembly Number	Description ⁽²⁾⁽³⁾⁽⁴⁾	Fire-Resistance Rating ⁽⁵⁾⁽⁶⁾⁽⁷⁾⁽⁸⁾	Typical Sound Transmission Class ⁽⁵⁾⁽⁶⁾⁽⁹⁾⁽¹⁰⁾ (STC)	Typical Impact Insulation Class ⁽⁵⁾⁽⁹⁾⁽¹¹⁾ (IIC)
Floors and Ceilings					
Cold Formed Steel Floor Joists ⁽²⁶⁾	F56c	F56 with <ul style="list-style-type: none"> • absorptive material in cavity • resilient metal channels spaced 406 mm o.c. • 15.9 mm Type X gypsum board 	1 h	67	41
	F56d	F56 with <ul style="list-style-type: none"> • absorptive material in cavity • resilient metal channels spaced 610 mm o.c. • 15.9 mm Type X gypsum board 	45 min [1 h] ⁽²⁴⁾	69	41
	F56e	F56 with <ul style="list-style-type: none"> • no absorptive material in cavity • resilient metal channels spaced 406 mm o.c. • 12.7 mm Type X gypsum board 	1 h	59	32
	F56f	F56 with <ul style="list-style-type: none"> • no absorptive material in cavity • resilient metal channels spaced 610 mm o.c. • 12.7 mm Type X gypsum board 	1 h	61	32
	F56g	F56 with <ul style="list-style-type: none"> • absorptive material in cavity • resilient metal channels spaced 406 mm o.c. • 12.7 mm Type X gypsum board 	1 h	66	40
	F56h	F56 with <ul style="list-style-type: none"> • absorptive material in cavity • resilient metal channels spaced 610 mm o.c. • 12.7 mm Type X gypsum board 	45 min [1 h] ⁽²⁴⁾	68	40
	F56i	F56 with <ul style="list-style-type: none"> • no absorptive material in cavity • resilient metal channels spaced 406 mm o.c. • 12.7 mm regular gypsum board 	—	58	32
	F56j	F56 with <ul style="list-style-type: none"> • no absorptive material in cavity • resilient metal channels spaced 610 mm o.c. • 12.7 mm regular gypsum board 	—	61	32
	F56k	F56 with <ul style="list-style-type: none"> • absorptive material in cavity • resilient metal channels spaced 406 mm o.c. • 12.7 mm regular gypsum board 	—	65	40
	F56l	F56 with <ul style="list-style-type: none"> • absorptive material in cavity • resilient metal channels spaced 610 mm o.c. • 12.7 mm regular gypsum board 	—	68	40
	Column 1	2	3	4	5

Table 2 (Cont'd)
Fire and Sound Resistance of Floors, Ceilings and Roofs⁽¹⁾

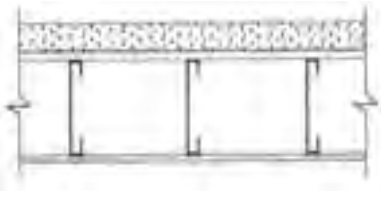
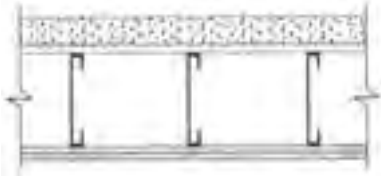
Type of Assembly	Assembly Number	Description ⁽²⁾⁽³⁾⁽⁴⁾	Fire-Resistance Rating ⁽⁵⁾⁽⁶⁾⁽⁷⁾⁽⁸⁾	Typical Sound Transmission Class ⁽⁵⁾⁽⁶⁾⁽⁹⁾⁽¹⁰⁾ (STC)	Typical Impact Insulation Class ⁽⁵⁾⁽⁹⁾⁽¹¹⁾ (IIC)
Floors and Ceilings					
Cold Formed Steel Floor Joists ⁽²⁶⁾	F57	<ul style="list-style-type: none"> • 50 mm concrete • 0.46 mm metal pan with a 19 mm rib • on steel joists spaced not more than 610 mm o.c. • 1 layer of gypsum board on ceiling side 			
	F57a	F57 with <ul style="list-style-type: none"> • no absorptive material in cavity • 15.9 mm Type X gypsum board 	—	45	26
	F57b	F57 with <ul style="list-style-type: none"> • absorptive material in cavity • 15.9 mm Type X gypsum board 	—	47	29
	F57c	F57 with <ul style="list-style-type: none"> • no absorptive material in cavity • 12.7 mm Type X gypsum board 	—	44	25
	F57d	F57 with <ul style="list-style-type: none"> • absorptive material in cavity • 12.7 mm Type X gypsum board 	—	46	28
	F57e	F57 with <ul style="list-style-type: none"> • no absorptive material in cavity • 12.7 mm regular gypsum board 	—	43	25
	F57f	F57 with <ul style="list-style-type: none"> • absorptive material in cavity • 12.7 mm regular gypsum board 	—	45	28
	F58	<ul style="list-style-type: none"> • 50 mm concrete • 0.38 mm metal pan with a 16 mm rib • on steel joists spaced not more than 610 mm o.c. • 2 layers of gypsum board on ceiling side 			
	F58a	F58 with <ul style="list-style-type: none"> • no absorptive material in cavity • 15.9 mm Type X gypsum board 	—	50	27
	F58b	F58 with <ul style="list-style-type: none"> • absorptive material in cavity • 15.9 mm Type X gypsum board 	—	52	30
	Column 1	2	3	4	5

Table 2 (Cont'd)
Fire and Sound Resistance of Floors, Ceilings and Roofs⁽¹⁾

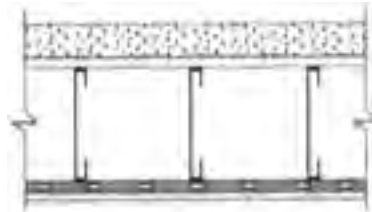
Type of Assembly	Assembly Number	Description ⁽²⁾⁽³⁾⁽⁴⁾	Fire-Resistance Rating ⁽⁵⁾⁽⁶⁾⁽⁷⁾⁽⁸⁾	Typical Sound Transmission Class ⁽⁵⁾⁽⁶⁾⁽⁹⁾⁽¹⁰⁾ (STC)	Typical Impact Insulation Class ⁽⁵⁾⁽⁹⁾⁽¹¹⁾ (IIC)
Floors and Ceilings					
Cold Formed Steel Floor Joists ⁽²⁶⁾	F58c	F58 with <ul style="list-style-type: none"> • no absorptive material in cavity • 12.7 mm Type X gypsum board 	—	48	27
	F58d	F58 with <ul style="list-style-type: none"> • absorptive material in cavity • 12.7 mm Type X gypsum board 	—	50	30
	F58e	F58 with <ul style="list-style-type: none"> • no absorptive material in cavity • 12.7 mm regular gypsum board 	—	48	27
	F58f	F58 with <ul style="list-style-type: none"> • absorptive material in cavity • 12.7 mm regular gypsum board 	—	50	30
	F59	<ul style="list-style-type: none"> • 50 mm concrete • 0.38 mm metal pan with a 16 mm rib • on steel joists spaced not more than 610 mm o.c. • with or without absorptive material in cavity • resilient metal channels spaced 406 mm or 610 mm o.c. • 1 layer of gypsum board on ceiling side 			
	F59a	F59 with <ul style="list-style-type: none"> • no absorptive material in cavity • resilient metal channels spaced 406 mm o.c. • 15.9 mm Type X gypsum board 	—	57	35
	F59b	F59 with <ul style="list-style-type: none"> • no absorptive material in cavity • resilient metal channels spaced 610 mm o.c. • 15.9 mm Type X gypsum board 	—	59	35
	F59c	F59 with <ul style="list-style-type: none"> • absorptive material in cavity • resilient metal channels spaced 406 mm o.c. • 15.9 mm Type X gypsum board 	—	64	43
	F59d	F59 with <ul style="list-style-type: none"> • absorptive material in cavity • resilient metal channels spaced 610 mm o.c. • 15.9 mm Type X gypsum board 	—	66	43
	Column 1	2	3	4	5

Table 2 (Cont'd)
Fire and Sound Resistance of Floors, Ceilings and Roofs⁽¹⁾

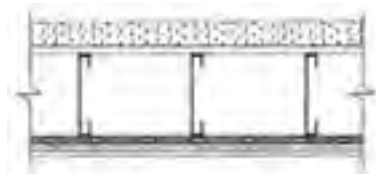
Type of Assembly	Assembly Number	Description ⁽²⁾⁽³⁾⁽⁴⁾	Fire-Resistance Rating ⁽⁵⁾⁽⁶⁾⁽⁷⁾⁽⁸⁾	Typical Sound Transmission Class ⁽⁵⁾⁽⁶⁾⁽⁹⁾⁽¹⁰⁾ (STC)	Typical Impact Insulation Class ⁽⁵⁾⁽⁹⁾⁽¹¹⁾ (IIC)
Floors and Ceilings					
Cold Formed Steel Floor Joists ⁽²⁶⁾	F59e	F59 with <ul style="list-style-type: none"> • no absorptive material in cavity • resilient metal channels spaced 406 mm o.c. • 12.7 mm Type X gypsum board 	—	56	34
	F59f	F59 with <ul style="list-style-type: none"> • no absorptive material in cavity • resilient metal channels spaced 610 mm o.c. • 12.7 mm Type X gypsum board 	—	56	34
	F59g	F59 with <ul style="list-style-type: none"> • absorptive material in cavity • resilient metal channels spaced 406 mm o.c. • 12.7 mm Type X gypsum board 	—	63	42
	F59h	F59 with <ul style="list-style-type: none"> • absorptive material in cavity • resilient metal channels spaced 610 mm o.c. • 12.7 mm Type X gypsum board 	—	65	42
	F59i	F59 with <ul style="list-style-type: none"> • no absorptive material in cavity • resilient metal channels spaced 406 mm o.c. • 12.7 mm regular gypsum board 	—	55	34
	F59j	F59 with <ul style="list-style-type: none"> • no absorptive material in cavity • resilient metal channels spaced 610 mm o.c. • 12.7 mm regular gypsum board 	—	57	34
	F59k	F59 with <ul style="list-style-type: none"> • absorptive material in cavity • resilient metal channels spaced 406 mm o.c. • 12.7 mm regular gypsum board 	—	62	42
	F59l	F59 with <ul style="list-style-type: none"> • absorptive material in cavity • resilient metal channels spaced 610 mm o.c. • 12.7 mm regular gypsum board 	—	64	42
	F60	<ul style="list-style-type: none"> • 50 mm concrete • 0.46 mm metal pan with a 19 mm rib • on steel joists spaced not more than 610 mm o.c. • with or without absorptive material in cavity • resilient metal channels spaced 406 mm or 610 mm o.c. • 2 layers of gypsum board on ceiling side 			
Column 1	2	3	4	5	6

Table 2 (Cont'd)
Fire and Sound Resistance of Floors, Ceilings and Roofs⁽¹⁾

Type of Assembly	Assembly Number	Description ⁽²⁾⁽³⁾⁽⁴⁾	Fire-Resistance Rating ⁽⁵⁾⁽⁶⁾⁽⁷⁾⁽⁸⁾	Typical Sound Transmission Class ⁽⁵⁾⁽⁶⁾⁽⁹⁾⁽¹⁰⁾ (STC)	Typical Impact Insulation Class ⁽⁵⁾⁽⁹⁾⁽¹¹⁾ (IIC)
Floors and Ceilings					
Cold Formed Steel Floor Joists ⁽²⁶⁾	F60a	F60 with <ul style="list-style-type: none"> • no absorptive material in cavity • resilient metal channels spaced 406 mm o.c. • 15.9 mm Type X gypsum 	1 h	62	36
	F60b	F60 with <ul style="list-style-type: none"> • no absorptive material in cavity • resilient metal channels spaced 610 mm o.c. • 15.9 mm Type X gypsum board 	1 h	64	36
	F60c	F60 with <ul style="list-style-type: none"> • absorptive material in cavity • resilient metal channels spaced 406 mm o.c. • 15.9 mm Type X gypsum board 	1 h	69	44
	F60d	F60 with <ul style="list-style-type: none"> • absorptive material in cavity • resilient metal channels spaced 610 mm o.c. • 15.9 mm Type X gypsum board 	45 min [1 h] ⁽²⁴⁾	71	44
	F60e	F60 with <ul style="list-style-type: none"> • no absorptive material in cavity • resilient metal channels spaced 406 mm o.c. • 12.7 mm Type X gypsum board 	1 h	60	36
	F60f	F60 with <ul style="list-style-type: none"> • no absorptive material in cavity • resilient metal channels spaced 610 mm o.c. • 12.7 mm Type X gypsum board 	1 h	62	36
	F60g	F60 with <ul style="list-style-type: none"> • absorptive material in cavity • resilient metal channels spaced 406 mm o.c. • 12.7 mm Type X gypsum board 	1 h	67	44
	F60h	F60 with <ul style="list-style-type: none"> • absorptive material in cavity • resilient metal channels spaced 610 mm o.c. • 12.7 mm Type X gypsum board 	45 min [1 h] ⁽²⁴⁾	69	44
	F60i	F60 with <ul style="list-style-type: none"> • no absorptive material in cavity • resilient metal channels spaced 406 mm o.c. • 12.7 mm regular gypsum board 	—	60	36
	F60j	F60 with <ul style="list-style-type: none"> • no absorptive material in cavity • resilient metal channels spaced 610 mm o.c. • 12.7 mm regular gypsum board 	—	62	36
Column 1	2	3	4	5	6

Table 2 (Cont'd)
Fire and Sound Resistance of Floors, Ceilings and Roofs⁽¹⁾

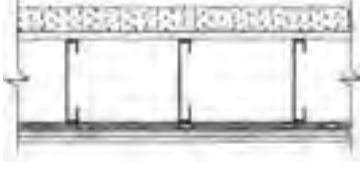
Type of Assembly	Assembly Number	Description ⁽²⁾⁽³⁾⁽⁴⁾	Fire-Resistance Rating ⁽⁵⁾⁽⁶⁾⁽⁷⁾⁽⁸⁾	Typical Sound Transmission Class ⁽⁵⁾⁽⁶⁾⁽⁹⁾⁽¹⁰⁾ (STC)	Typical Impact Insulation Class ⁽⁵⁾⁽⁹⁾⁽¹¹⁾ (IIC)
Floors and Ceilings					
Cold Formed Steel Floor Joists ⁽²⁶⁾	F60k	F60 with <ul style="list-style-type: none"> • absorptive material in cavity • resilient metal channels spaced 406 mm o.c. • 12.7 mm regular gypsum board 	—	67	44
	F60l	F60 with <ul style="list-style-type: none"> • absorptive material in cavity • resilient metal channels spaced 610 mm o.c. • 12.7 mm regular gypsum board 	—	69	44
	F61	<ul style="list-style-type: none"> • 50 mm concrete • 0.38 mm metal pan with a 16 mm rib • on steel joists spaced not more than 610 mm o.c. • with or without absorptive material in cavity • resilient metal channels spaced 406 mm or 610 mm o.c. • 2 layers of gypsum board on ceiling side 			
	F61a	F61 with <ul style="list-style-type: none"> • no absorptive material in cavity • resilient metal channels spaced 406 mm o.c. • 15.9 mm Type X gypsum board 	1 h	62	32
	F61b	F61 with <ul style="list-style-type: none"> • steel joists spaced 406 mm o.c. • no absorptive material in cavity • resilient metal channels spaced 610 mm o.c. • 15.9 mm Type X gypsum board 	1 h	64	32
	F61c	F61 with <ul style="list-style-type: none"> • steel joists spaced 610 mm o.c. • no absorptive material in cavity • resilient metal channels spaced 610 mm o.c. • 15.9 mm Type X gypsum board 	—	65	29
	F61d	F61 with <ul style="list-style-type: none"> • absorptive material in cavity • resilient metal channels spaced 406 mm o.c. • 15.9 mm Type X gypsum board 	1 h	68	37
	F61e	F61 with <ul style="list-style-type: none"> • steel joists spaced 406 mm o.c. • absorptive material in cavity • resilient metal channels spaced 610 mm o.c. • 15.9 mm Type X gypsum board 	1 h	66	34
	Column 1	2	3	4	5

Table 2 (Cont'd)
Fire and Sound Resistance of Floors, Ceilings and Roofs⁽¹⁾

Type of Assembly	Assembly Number	Description ⁽²⁾⁽³⁾⁽⁴⁾	Fire-Resistance Rating ⁽⁵⁾⁽⁶⁾⁽⁷⁾⁽⁸⁾	Typical Sound Transmission Class ⁽⁵⁾⁽⁶⁾⁽⁹⁾⁽¹⁰⁾ (STC)	Typical Impact Insulation Class ⁽⁵⁾⁽⁹⁾⁽¹¹⁾ (IIC)
Floors and Ceilings					
Cold Formed Steel Floor Joists ⁽²⁶⁾	F61f	F61 with <ul style="list-style-type: none"> • steel joists spaced 610 mm o.c. • absorptive material in cavity • resilient metal channels spaced 610 mm o.c. • 15.9 mm Type X gypsum board 	—	71	34
	F61g	F61 with <ul style="list-style-type: none"> • no absorptive material in cavity • resilient metal channels spaced 406 mm o.c. • 12.7 mm Type X gypsum board 	1 h	62	32
	F61h	F61 with <ul style="list-style-type: none"> • steel joists spaced 406 mm o.c. • no absorptive material in cavity • resilient metal channels spaced 610 mm o.c. • 12.7 mm Type X gypsum board 	1 h	64	32
	F61i	F61 with <ul style="list-style-type: none"> • steel joists spaced 610 mm o.c. • no absorptive material in cavity • resilient metal channels spaced 610 mm o.c. • 12.7 mm Type X gypsum board 	—	64	28
	F61j	F61 with <ul style="list-style-type: none"> • absorptive material in cavity • resilient metal channels spaced 406 mm o.c. • 12.7 mm Type X gypsum board 	1 h	68	36
	F61k	F61 with <ul style="list-style-type: none"> • steel joists spaced 406 mm o.c. • absorptive material in cavity • resilient metal channels spaced 610 mm o.c. • 12.7 mm Type X gypsum board 	1 h	64	32
	F61l	F61 with <ul style="list-style-type: none"> • steel joists spaced 610 mm o.c. • no absorptive material in cavity • resilient metal channels spaced 610 mm o.c. • 12.7 mm Type X gypsum board 	—	70	34
	Column 1	2	3	4	5

Table 2 (Cont'd)
Fire and Sound Resistance of Floors, Ceilings and Roofs⁽¹⁾

Type of Assembly	Assembly Number	Description ⁽²⁾⁽³⁾⁽⁴⁾	Fire-Resistance Rating ⁽⁵⁾⁽⁶⁾⁽⁷⁾⁽⁸⁾	Typical Sound Transmission Class ⁽⁵⁾⁽⁶⁾⁽⁹⁾⁽¹⁰⁾ (STC)	Typical Impact Insulation Class ⁽⁵⁾⁽⁹⁾⁽¹¹⁾ (IIC)
Roofs					
Wood Roof Trusses	R1	<ul style="list-style-type: none"> • wood roof trusses spaced not more than 610 mm o.c. • 1 layer 15.9 mm Type X gypsum board 	45 min	—	—
Roofs - Rating Provided by Membrane Only					
	M1	<ul style="list-style-type: none"> • supporting members spaced not more than 610 mm o.c. • 1 layer 15.9 mm Type X gypsum board 	30 min	—	—
	M2	<ul style="list-style-type: none"> • supporting members spaced not more than 610 mm o.c. • 2 layers 15.9 mm Type X gypsum board 	1 h	—	—
Column 1	2	3	4	5	6

Notes to Table 2:

- (1) See Figure 1 for butt joint detail of single layer gypsum board application, Figure 2 for butt joint detail of double layer gypsum board application, Figure 3 for example of steel furring channel and Figure 4 for example of resilient metal channel.
- (2) For assemblies with a ceiling consisting of a single layer of gypsum board on resilient metal channels to obtain the listed ratings, the resilient metal channel arrangement at the gypsum board butt end joints should be as shown in Figure 1.
- (3) For assemblies with a ceiling consisting of 2 layers of gypsum board on resilient metal channels to obtain the listed ratings, the fastener and resilient metal channel arrangement at the gypsum board butt end joints should be as shown in Figure 2.
- (4) The fire-resistance rating and sound transmission class values given are for a minimum thickness of subfloor or deck as shown. Minimum subfloor thickness required is determined by structural member spacing (see Table 9.23.14.5.A. of Division B). Thicker subflooring or decking is also acceptable.
- (5) Sound absorptive material includes
 - (i) fibre processed from rock, slag or glass, and
 - (ii) loose-fill or spray-applied cellulose fibre.

To obtain the listed sound transmission class rating, the nominal insulation thickness is 150 mm for rock, slag, or glass fibres or loose-fill cellulose fibre, and 90 mm for spray-applied cellulose fibre, unless otherwise specified. Absorptive material will affect the sound transmission class by approximately adding or subtracting 1 per 50 mm change of thickness. However, no additional sound transmission class value is achieved by adding a greater thickness of insulation than the depth of the assembly.
- (6) The fire-resistance rating and sound transmission class values are based on the spacing of ceiling supports as noted. [See also Table Note (10)]. A narrower spacing will be detrimental to the sound transmission class rating, but not to the fire-resistance rating.
- (7) To obtain the listed rating, the type and spacing of fasteners are as described in and installed in accordance with Subsection 9.29.5. of Division B or CSA A82.31-M1980, "Gypsum Board Application":
 - (i) fastener distance to board edges and butt ends shall be no less than 38 mm, except for fasteners on the butt ends of the base layer in ceilings with two layers (see Figure 2), and
 - (ii) fasteners are spaced not more than 305 mm o.c.

- (8) See Sentence 1.2.1.(2) in MMAH Supplementary Standard SB-2, "Fire Performance Ratings" for the significance of fire-resistance ratings.
- (9) The sound transmission class values given in the Table are for the minimum depth of structural member noted in the description and applicable Table notes. To obtain sound transmission class values for structural members deeper than that minimum, add 1 to the sound transmission class value in the Table for each 170 mm increase in structural member depth.
- (10) The sound transmission class values given in the Table are for structural member spacing of 305 mm o.c., unless otherwise noted in the description and applicable Table notes. To obtain sound transmission class values for assemblies with structural members spaced more than 500 mm o.c., add 1 to the sound transmission class value in the Table.
- (11) The impact insulation class values given are for floor assemblies tested with no finished flooring.
- (12) Wood floor joists are:
- wood joists with a minimum member size of 38 mm (width) x 235 mm (depth), except as otherwise noted [See Table Note (15)], or
 - wood I-joists with a minimum flange size of 38 mm x 38 mm, a minimum OSB or plywood web thickness of 9.5 mm, and a minimum joist depth of 241 mm.
- (13) Except where assemblies with wood I-joists are tested according to CAN/ULC-S101-14, "Fire Endurance Tests of Building Construction and Materials", the fire-resistance rating values apply only to I-joists that have been fabricated with a phenolic-based structural wood adhesive complying with CSA O112.10-08, "Evaluation of Adhesives for Structural Wood Products (Limited Moisture Exposure)". For I-joists with flanges made of laminated veneer lumber (LVL), the fire-resistance rating values apply only where the adhesive used in the LVL fabrication is a phenolic-based structural wood adhesive complying with CSA O112.9-10, "Evaluation of Adhesives for Structural Wood Products (Exterior Exposure)".
- (14) The fire-resistance rating value within square brackets is achieved only where absorptive material includes spray-applied cellulose fibre with
- adhesive that is capable of providing a minimum cohesive/adhesive bond strength per unit area of 5 times the weight of the material under the test plate when tested in accordance with ASTM E736-00, "Cohesion/Adhesion of Sprayed Fire-Resistive Materials Applied to Structural Members",
 - a minimum density of 35 kg/m³, and
 - a minimum thickness of 90 mm on the underside of the subfloor or deck, of 90 mm on the sides of the structural members, and for cold-formed steel joists, of 13 mm on the underside of the bottom flange other than at resilient metal channel locations.
- (15) The fire-resistance rating value within square brackets only applies to assemblies with solid wood joists and is achieved only where absorptive material includes:
- fibre processed from rock or slag with a minimum thickness of 90 mm and a minimum surface area mass of 2.8 kg/m², or
 - spray-applied cellulose fibre with a minimum density of 50 kg/m³ and a minimum depth of 90 mm on the underside of the subfloor and of 90 mm on the sides of the floor joists.
- (16) The fire-resistance rating, sound transmission class and impact insulation class values given are also applicable to assemblies with 38 mm (width) x 184 mm (depth) solid wood joists.
- (17) The fire-resistance rating value within square brackets is achieved only where absorptive material includes:
- fibre processed from rock or slag with a minimum thickness of 90 mm and a minimum surface area mass of 2.8 kg/m², or
 - spray-applied cellulose fibre with a minimum density of 50 kg/m³ and a minimum depth of 90 mm on the underside of the subfloor and of 90 mm on the webs or the sides of the structural members.
- (18) The fire-resistance rating, sound transmission class and impact insulation class values within the square brackets only apply to assemblies with solid wood joists and are achieved only where absorptive material includes dry-blown cellulose fibre with a minimum density of 40 kg/m³ filling the entire cavity; the cellulose fibre is supported on zinc-coated (galvanized) steel poultry fence fabric conforming to ASTM A390-06, "Zinc-Coated (Galvanized) Steel Poultry Fence Fabric (Hexagonal and Straight Line)" which has 25 mm wide hexagonal mesh openings and 0.81 mm thick (20-gauge) wire and is attached to wood joists with metal staples having legs that are 50 mm long.

- (19) The fire-resistance rating and sound transmission class values are achieved only where absorptive material includes:
- fibres processed from rock or slag that fills the joist cavity and has a minimum surface area mass of 2.8 kg/m^2 , and for structural members at least 270 mm in depth, the fibre includes three layers each of which has a minimum thickness of 90 mm, or
 - dry-blown cellulose fibre with a minimum density of 40 kg/m^3 filling the entire cavity; the cellulose fibre is supported on zinc-coated (galvanized) steel poultry fence fabric conforming to ASTM A390-06, "Zinc-Coated (Galvanized) Steel Poultry Fence Fabric (Hexagonal and Straight Line)" which has 25 mm wide hexagonal mesh openings and 0.81 mm thick (20-gauge) wire and is attached to wood joists or wood I-joists with metal staples having legs that are 50 mm or 30 mm long, respectively.
- (20) The fire-resistance rating value only applies to assemblies with wood I-joists with flanges with a minimum thickness of 38 mm and a minimum width of 63 mm.
- (21) The fire-resistance rating and sound transmission class values are achieved only where absorptive material includes:
- fibres processed from rock or slag that fills the joist cavity and has a minimum surface area mass of 2.8 kg/m^2 , and for structural members at least 270 mm in depth, the fibre includes three layers each of which has a minimum thickness of 90 mm, or
 - dry-blown cellulose fibre with a minimum density of 40 kg/m^3 filling the entire cavity; the cellulose fibre is supported on zinc-coated (galvanized) steel poultry fence fabric conforming to ASTM A390-06, "Zinc-Coated (Galvanized) Steel Poultry Fence Fabric (Hexagonal and Straight Line)" which has 25 mm wide hexagonal mesh openings and 0.81 mm thick (20-gauge) wire and is attached to wood joists with metal staples having legs that are 50 mm long.
- (22) The fire-resistance rating values given only apply to assemblies with solid wood joists spaced not more than 406 mm o.c. No information is available for assemblies constructed with wood I-joists.
- (23) Wood floor trusses are:
- metal plate-connected wood trusses with wood framing members not less than 38 mm x 64 mm, metal connector plates not less than 1 mm (nominal) thick with teeth not less than 8 mm long, and a minimum truss depth of 305 mm,
 - metal web wood trusses with wood chords not less than 38 mm x 64 mm, V-shaped webs made from galvanized steel of 1 mm (nominal) thickness with plate areas having teeth not less than 8 mm long, and a minimum truss depth of 286 mm, or
 - fingerjoined wood trusses with glued fingerjoined connections, chord members not less than 38 mm x 64 mm, web members not less than 38 mm x 38 mm and a minimum truss depth of 330 mm, all of which is glued together with an R-14 phenol-resorcinol resin conforming to CSA O112.10-08, "Evaluation of Adhesives for Structural Wood Products (Limited Moisture Exposure)".
- (24) The fire-resistance rating value within square brackets is achieved only where absorptive material includes fibre processed from rock or slag with a minimum thickness of 90 mm and a minimum surface area mass of 2.8 kg/m^2 .
- (25) The fire-resistance rating and sound transmission class values within square brackets are achieved only where absorptive material includes dry-blown cellulose fibre with a minimum density of 40 kg/m^3 filling the entire cavity; the cellulose fibre is supported on zinc-coated (galvanized) steel poultry fence fabric conforming to ASTM A390-06, "Zinc-Coated (Galvanized) Steel Poultry Fence Fabric (Hexagonal and Straight Line)" which has 25 mm wide hexagonal mesh openings and 0.81 mm thick (20-gauge) wire and is attached to wood trusses with metal staples having legs that are 38 mm long.
- (26) Cold-formed steel floor joists (C-shaped joists) are members with a minimum size of 41 mm (width) x 203 mm (depth) x 1.22 mm (material thickness).
- (27) The fire-resistance rating value within square brackets is achieved only where absorptive material includes spray-applied cellulose fibre with a minimum density of 50 kg/m^3 and a minimum thickness of 90 mm on the underside of the subfloor, of 90 mm on the sides of the cold-formed steel floor joists, and of 13 mm on the underside of the bottom flange other than at resilient metal channel locations.

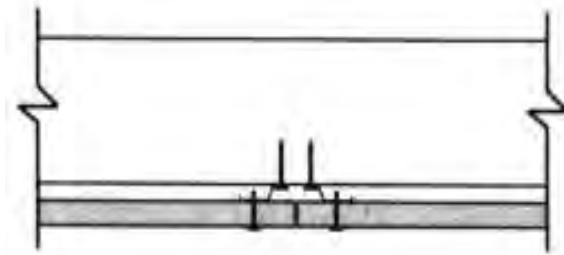


Figure 1
Butt Joint Detail of Single Gypsum Board Layer Application

Notes to Figure 1:

- (1) Figure is for illustration purposes only and is not to scale.
- (2) The structural member can be any one of the types described in the Table.
- (3) Adjacent gypsum board butt ends are to be attached to separate resilient channels using regular Type S screws, located a minimum of 38 mm from the butt end.

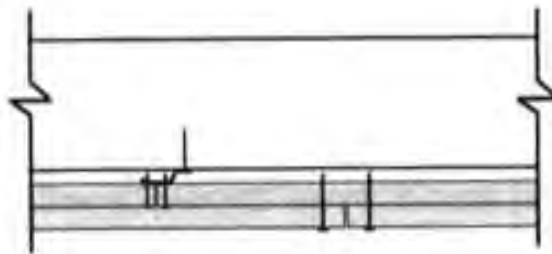


Figure 2
Butt Joint Detail of Double Gypsum Board Layer Application

Notes to Figure 2:

- (1) Figure is for illustration purposes only and is not to scale.
- (2) The structural member can be any one of the types described in the Table.
- (3) Base layer butt ends can be attached to a single resilient channel using regular Type S screws.
- (4) Type G screws measuring a minimum of 32 mm in length and located a minimum of 38 mm from the butt end are to be used to fasten the butt ends of the face layer to the base layer.

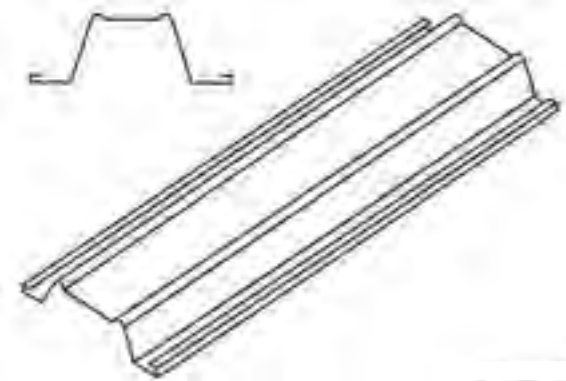


Figure 3
Example of Steel Furring Channel

Notes to Figure 3:

(1) Figure is for illustration purposes only and is not to scale.

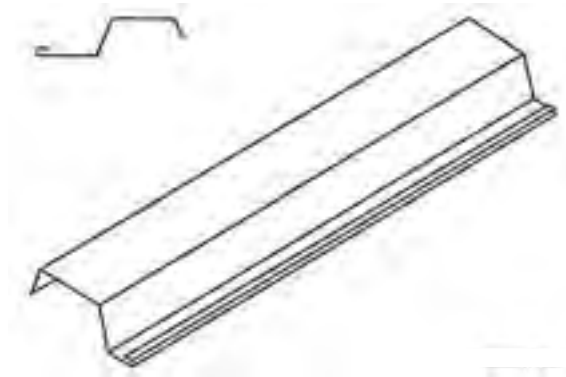


Figure 4
Example of Resilient Metal Channel

Notes to Figure 4:

(1) Figure is for illustration purposes only and is not to scale.

MMAH Supplementary Standard SB-4

Measures for Fire Safety in High Buildings

January 15, 2019 Update

COMMENCEMENT

MMAH Supplementary Standard SB-4 comes into force on the 1st day of January, 2014.

r11.1 SB-4 as amended by Ontario Regulation 88/19 comes into force on the 1st day of January, 2020.

EDITORIAL

e1 Editorial correction issued for January 1st, 2020.

© Copyright

© Copyright Queen's Printer for Ontario 2019

All rights reserved.

Questions regarding copyright, including reproduction and distribution, may be directed to the Director,
Building and Development Branch of the Ministry of Municipal Affairs and Housing.

CONTENTS

	Page
Introduction	1
Section 1: Building Code Provisions	2
Section 2: Scope of Measures for Fire Safety in Existing High Buildings	12
e1 Section 3: Measures for Life Safety in Existing High Buildings	30
Appendix A to SB-4: Graphs for Applying Smoke Control Measures	53
Appendix B to SB-4: Assumptions Used in Developing Fire Safety Measures.....	59
Appendix C to SB-4: Check of a Smoke Control System	69
References	70

SB-4 Measures for Fire Safety in High Buildings

(This Supplementary Standard is based in large measure on the Supplement to the National Building Code of Canada 1990 and the Appendix Notes to Subsection 3.2.6. of the National Building Code of Canada 2015)

Introduction

11.1 Experience with high buildings has demonstrated that the time required for the complete evacuation in these buildings can exceed that which is considered necessary for the safe egress of all occupants. Studies of the "chimney effect" and observations of smoke movement in fire conditions have shown that measures for containing a fire on a lower storey will not always prevent the movement of smoke through the elevator, stair or other vertical shafts to the upper storeys of a high building. Occupants of high buildings, and particularly those on upper storeys, may be faced with severe smoke conditions from fires occurring in storeys below them before their own evacuation is possible. The provisions in Section 3.2.6. of Division B in the 2012 Building Code are intended to mitigate the risk to occupants of high buildings by restricting the generation and movement of smoke, ensuring adequate fire safety and by providing efficient access for firefighters.

Application of SB-4: Design of New Buildings and Renovations to Existing Buildings

This Standard is intended to assist in complying with the provisions in Subsection 3.2.6. of Division B of the Code.

Section 1: Section 1 of this standard, describes compliance with the requirements of Subsection 3.2.6. of Division B of the Code and is applicable to both new and existing buildings. The Code user should review the provisions contained in Section 1 with the corresponding provisions in Subsection 3.2.6. of Division B and determine the applicability of each. Provision [3.2.6.2.(1)] is applicable to the renovation of existing buildings that are sprinklered. Provision [3.2.6.2.(6)] is specifically applicable to the renovation of existing buildings that are not sprinklered.

Section 2: Section 2 of this standard summarizes smoke control measures applicable to certain common building designs. Compliance with one of these measures is considered to meet the requirements of the code for smoke control in existing buildings.

Section 3: Section 3 further details the measures that are referenced in Section 2 and can be utilized to achieve the strategies described in Section 2.

Smoke Control in High Buildings

The designer should understand the principles that govern smoke movement, and realize that the information contained in this Supplementary Standard is intended to be applied to buildings with conventional configurations. If the building under consideration has unconventional characteristics, the designer must determine the extent to which the contents of this standard are applicable and adjust the design accordingly.

This is particularly true of strategies employing air-handling systems where, for example, a realistic assessment of the leakage characteristics of the enclosures of spaces into which air is introduced may be critical. In this context, special attention is drawn to the building pressurization approach used in conjunction with a smoke shaft. The recommendations contained in this Supplementary Standard for this approach were developed assuming a building with fairly uniform leakage characteristics. Where a building or building element departs substantially from this model, the design must be adjusted to compensate. An example of the latter condition would be a building which contains at the lower levels a large shopping complex of much greater floor area than at the higher levels.

Buildings regulated by Subsection 3.2.6. of Division B will likely be in an area served by a fire department capable of an early response and that the response will be directed by the officer in charge of the fire department responding to the emergency. It is important that firefighters be provided with a smoke free access to fire floors below grade. Provisions are included to separate exit stairways serving storeys above grade from those serving storeys below grade, and to limit entry of smoke into these shafts. Similarly, elevator hoistways and service shafts are required to be provided with a separation near grade, or be designed to limit their acting as paths of smoke movement into upper floor areas from storeys below grade.

During a fire emergency, it is assumed that the occupants of the floor on which the fire occurs will leave by exit stairs immediately following the sounding of a fire alarm, and that occupants of the floor immediately above the floor on which the fire occurs will be advised to leave by the first fire department officer on the scene or other person assigned this responsibility. Occupants of all other floors may remain on their floors unless otherwise directed. It is also assumed that the owner of the building has prepared and filed a comprehensive fire safety plan to safeguard the building occupants and that the building supervisory staff are familiar with the provisions of Subsection 3.2.6. of Division B and with their responsibilities under the fire safety plan.

It is further assumed that the cumulative population of storeys below grade divided by 1.8 times the width in metres of all exit stairs at the storey under consideration will not exceed the 300 limit referred to in Article 3.2.6.1. of Division B, and that occupants of storeys below grade will evacuate the building by the stair shafts immediately after the discovery of a fire in a storey below grade.

The Building Code requires that a check be made of the smoke control system when requested by the authority having jurisdiction in accordance with the procedures described in Appendix C of this Supplementary Standard. This check will indicate deficiencies caused by inexact estimates of the leakage characteristics or of air supply requirements and, in all but the most extreme cases, will provide an opportunity for appropriate adjustments before the system is put into service.

Section 1 Building Code Provisions

r11.1 [3.2.6.2.(1)] Limits to Smoke Movement in New and Existing Buildings that are Sprinklered

(1) A new or an existing building that is sprinklered and is required to conform to the provisions of Subsection 3.2.6. of Division B shall be designed in accordance with Sentences 3.2.6.2.(2) to (5) and this Supplementary Standard to limit the danger to occupants and firefighters from exposure to smoke in a building fire.

(2) Except as required in Sentence (1), where smoke control system of an existing sprinklered building is materially altered, the altered portions of the system shall meet the requirements of Sentences 3.2.6.2.(2) to (5) and this Supplementary Standard to limit the danger to occupants and firefighters from exposure to smoke in a building fire.

Electrical Sprinkler Supervision

- (3) The sprinkler system is equipped with a water flow and supervisory signal system that will,
- (a) transmit automatically a waterflow signal directly to the fire department, or through an independent central station,
 - (b) transmit automatically other supervisory signals to a proprietary control centre or to an independent central station, and
 - (c) actuate a signal at the central alarm and control facility described in Article 3.2.6.7. of Division B.

[3.2.6.2.(2)] Stairway Protection Below Lowest Exit Level

These provisions are intended to apply to common building designs. Where a stair serving floors below the lowest exit level is open to the exterior or the stair serves only one storey below grade, compliance with the following provisions may not be necessary.

A stairway serving floors below the lowest exit level is considered to comply with the intent of Sentence 3.2.6.2.(2) of Division B if all of the following conditions are satisfied.

- (1) The stairway has a vent or door to the outdoors at or near the top of the stair shaft that has an openable area of not less than 0.1 m^2 for each storey served by the stairway, less 0.01 m^2 for each weatherstripped door and 0.02 m^2 for each door that is not weatherstripped opening into the stairway.
- (2) The stairway is enclosed in a shaft that
 - (a) does not pass through the floor above the lowest exit level and is separate from a shaft that contains a stairway serving upper storeys, or
 - (b) contains a stairway serving upper storeys, but is separated from that stairway at the lowest exit level by a fire separation having a fire resistance rating not less than that required for the shaft enclosure.
- (3) The stairway is provided with equipment capable of maintaining a flow of air introduced at or near the bottom of the stair shaft, at a rate equal to $0.47 \text{ m}^3/\text{s}$ for each storey served by the stairway.

[3.2.6.2.(3)] Requirements for Stair Shafts Serving Storeys Above Lowest Exit Level

Open doors and vents at the bottom of a stair shaft that serve storeys above the lowest exit level, will create a positive pressure in the shaft relative to adjacent floor areas and thus prevent smoke infiltration into the shaft. This pressure differential, created as a result of the stack effect will be the greatest during the winter, when the difference in temperature between the interior and the exterior of the building is most pronounced. If a stair shaft does not have a direct opening to the exterior, alternative means must be provided to achieve the pressure differential and consequent smoke control. In the instance where a corridor or vestibule is used as a link between the exit level of an interior stair shaft and the outdoors, it will be necessary to assess the reliability and performance of the overall system in creating the necessary stairway pressurization. The probability of all doors or closures being opened at the same time, as well as the size of the vestibule and its impact on the overall smoke control system, are factors that need to be considered.

- r11.1**
- (1) Each stairway that serves storeys above the lowest exit level shall have a vent to the outdoors, at or near the bottom of the stair shaft, that,
 - (a) has an openable area of 0.05 m^2 for every door between the stair shaft and a floor area, but not less than 1.8 m^2 ,
 - (b) opens directly to the outdoors or into a vestibule that has a similar opening to the outdoors, and
 - (c) has a door or closure that,
 - (i) is openable manually, and
 - (ii) can remain in the open position during a fire emergency.

If mechanical methods are used to develop a positive pressure in a stair shaft, a minimum pressure differential of 12 Pa is recommended to prevent smoke migration from floor areas in a sprinklered building where fire temperatures are controlled and smoke movement may be dominated by stack effect in a stair shaft. During a fire emergency, persons will be entering and exiting a stair shaft as they move to a place of safety and under these conditions the number of doors open to the stair shaft cannot be predetermined. The number will vary depending on the occupancy of the building, population density and the evacuation plan for the building. It should be assumed that two doors are open. This is based in part as a practical level for most buildings and considers the positive fire experience in sprinklered buildings.

The maximum pressure differential created by a mechanical system should not prevent doors to the stair shafts from being opened. A specific maximum value cannot be given, as this value will depend on the door opening force and size of the door. These values should be calculated for each specific case. A maximum value of 130 N is suggested by research as the force that can be opened by the majority of people in most occupancies, however this value is above the maximum value of 90 N generally specified in this Code (Section 3.4. of Division B). The use of values below 130 N can create a practical problem in achieving effective smoke control as it is difficult to design for the acceptable minimum and maximum pressure differential range. Special consideration may need to be given to doors located in a barrier free path of travel.

Care should be taken by designers and by building and fire officials in implementation of these requirements. Assumptions involved in the design of a smoke control system may be different from final construction conditions. For this reason each system should be tested after installation to ensure that the design intent is met. The minimum pressure differential is not intended to apply to locations in stair shafts when nearby doors are open to adjacent floor areas.

[3.2.6.2.(4)] Limiting Smoke Movement into Storeys Above Lowest Exit Level.

Measures to prevent the migration of smoke from floor areas below the lowest exit storey into upper storeys include the following.

- (1) An elevator hoistway that passes through the floor above the lowest exit storey should not penetrate the floor of the storey immediately below the lowest exit storey, unless there is a vestibule between the shaft and each floor area below the lowest exit storey that
 - (a) has a fire separation, with a fire resistance rating not less than 45 min, between the vestibule and any public corridor,
 - (b) has a fire separation, with a fire resistance rating not less than that required for an exit by Article 3.4.4.1. of Division B, between the vestibule and any stair or elevator enclosure or any part of a floor area, other than a public corridor, and
 - (c) except for elevator hoistway entrances, has a self-closing device on any door through the fire separation required by Clauses (a) and (b), with the door opening in the direction of travel from the floor area to the exit stairway.

- (2) A vertical service space, other than an elevator hoistway, that passes through the floor assembly above the lowest exit storey, should be provided with a tight fitting noncombustible seal or fire stop at the floor assembly of the storey immediately below the lowest exit storey, unless
 - (a) the vertical service space is vented to the outdoors at the top and the vent has an openable area that is not less than
 - (i) that obtained from Graph 1 in Appendix A to SB-4 if the vertical service space is in a building in which other shafts are not mechanically pressurized, or
 - (ii) that obtained from Graph 2 in Appendix A to SB-4 if the vertical service space is in a building in which other shafts are mechanically pressurized,
 - (b) for a shaft that serves floor areas above the lowest exit storey, a vent is located
 - (i) at or near the top of the shaft if the shaft is above the mid height of the building, or
 - (ii) at or near the foot of the shaft at or near the exit level if the top of the shaft is below the mid height of the building, or
 - (c) for a shaft that serves floor areas below the lowest exit storey, a vent is located at or near the top of the shaft.

- (3) Any closure provided for a vent opening referred to in Sentence (2) must be openable:
 - (a) manually,
 - (b) on a signal from a smoke detector located at or near the top of the shaft, and
 - (c) by a control device located at the central alarm and control facility.

r11.1 [3.2.6.2.(5)] Air Moving Fans

(1) Except for exhaust fans in kitchens, washrooms and bathrooms in dwelling units, and except for fans used for smoke venting in Article 3.2.6.6. of Division B, air moving fans in a system that serves more than 2 storeys shall be designed and installed so that in the event of a fire these fans can be stopped by means of a manually operated switch at the central alarm and control facility.

r11.1 Equivalent Measure

Where a building is designed in accordance with Measure A as described in Sections 2 and 3 of this Supplementary Standard, the building shall be deemed to comply with Sentences 3.2.6.2.(2) to (5) of Division B of the Building Code.

[3.2.6.2.(6)] Limits to Smoke Movement in Existing Buildings that are Not Sprinklered

(1) An existing building that is not sprinklered and that is governed by the provisions of Subsection 3.2.6. of Division B shall be designed in accordance with Sentences (2) to (8) to limit the danger to occupants and firefighters from exposure to smoke in a building fire.

Smoke Protection for Floor Areas

(2) Except as provided in Sentences (5) to (8), a building referred to in Sentence (1), shall be designed so that, during a period of 2 h after the start of a fire, all floor areas that are above the lowest exit storey will not contain more than 1% by volume of contaminated air from the fire floor, assuming an outdoor temperature equal to the January design temperature on a 2.5% basis determined in conformance with Supplementary Standard SB-1.

Smoke Protection for Exit Stairs

(3) Except as provided in Sentences (7) and (8), a building referred to in Sentence (1), shall be designed so that during a period of 2 h after the start of a fire, the limit described in Sentence (2) on the movement of contaminated air into other floor areas is not exceeded in,
(a) each exit stair serving storeys above the lowest exit level, and
(b) each exit stair serving storeys below the lowest exit level.

Smoke Protection for Firefighters' Elevators

(4) Except as provided in Sentence (7), a building referred to in Sentence (1), shall be designed so that during a period of 2 h after the start of a fire, the limit described in Sentence (2) on the movement of contaminated air into other floor areas is not exceeded in a shaft that contains an elevator for use by firefighters required by Article 3.2.6.5. of Division B.

Areas of Refuge

(5) In a building of Group C major occupancy classification, the requirements of Sentence (2) are waived where occupants above the first storey can enter and be safely accommodated in floor areas or parts of floor areas that shall
(a) be designated and identified in the building as areas of refuge,
(b) be located on every storey except if the building is not more than 75 m, measured between grade and the floor level of the top storey, on every fifth storey,
(c) provide not less than 0.5 m² of floor space per ambulatory occupant and 1.5 m² of floor space per non-ambulatory occupant,
(d) have access corridors and doors leading to each designated part of a floor area on the same storey sufficient to provide 3.67 mm of width for every person who may have to use these passages to reach the designated part of a floor area,

- (e) have access stairs from intervening storeys leading to each designated part of a floor area sufficient to provide 5.5 mm of width for every person who may have to use these stairs to reach the designated part of a floor area, and
- (f) not contain more than 1% by volume of contaminated air from the fire floor during a period of 2 h after the start of a fire, assuming an outdoor temperature equal to the January design temperature on a 2.5% basis determined in conformance with Supplementary Standard SB-1.

Lower Buildings

- (6) The requirements of Sentence (2) are waived in a building of Group C major occupancy classification where,
 - (a) the building is not more than 75 m high measured between grade and the floor level of the top storey, and
 - (b) the number of occupants of storeys above grade is not more than 3.6 times the area in square metres of treads and landings in the exit stairs serving these storeys.

Residential Buildings

- (7) The requirements of Sentences (2) and (4) and Clause (3)(a) are waived in a building of Group C major occupancy classification, where
 - (a) each suite above grade has direct access to an exterior balcony that conforms to the requirements of Sentence 3.3.1.7.(7) of Division B,
 - (b) each stairway that serves storeys above the lowest exit level is vented to the outdoors at or near the bottom of the stair shaft,
 - (c) measures are taken to limit movement of smoke from a fire in a floor area below the lowest exit storey into upper storeys, and
 - (d) where, except for exhaust fans in kitchens, washrooms and bathrooms in dwelling units, air moving fans are designed and installed so that in the event of a fire such fans can be stopped by means of a manually operated switch at the central alarm and control facility where the system serves more than 2 storeys.
- (8) The requirements of Sentences (2) and (3) are waived in a Group C major occupancy apartment building.

[3.2.6.3.(1)] Connected Buildings

11.1 The measures described here are intended to prevent movement of smoke from one building to another where at least one building is a high building. They are of particular significance for two buildings of unequal height that are joined together. The measures suggested include the provision of a large opening to the outdoors in a connecting vestibule enabling smoke entering through leakage areas around doors to be vented to the outdoors, or pressurization to maintain a higher pressure in the vestibule than in adjacent spaces, as illustrated in Figures 17 to 18A in Section 2.

The provisions for protection of openings are described in terms applicable doorways, as this is expected to be the most commonly occurring opening. Openings other than doorways should be avoided if possible. Openings should be protected by an airlock that gives the at least the same level of protection as the vestibule described below.

The requirement of Article 3.2.6.3. of Division B limiting the movement of smoke from one building to another may be met by incorporating in the link between the buildings the provisions of Sentences (1) and (2) described below.

- (1) A firewall conforming to Subsection 3.1.10. of Division B is constructed between one building and the other with any opening in the firewall protected against the passage of smoke by a vestibule that has
 - (a) a fire separation between the vestibule and a public corridor with a fire resistance rating not less than 45 min,
 - (b) a fire separation between the vestibule and the remainder of the floor area, other than a public corridor, with a fire resistance rating not less than that required by Article 3.4.4.1. of Division B for an exit,
 - (c) a fire separation between the vestibule and a stair enclosure or elevator hoistway with a fire resistance rating not less than that required by Article 3.4.4.1. of Division B for an exit, and
 - (d) any door in the fire separation required by Clauses (a), (b) or (c), except for an elevator entrance, provided with a self-closing device as required by Article 3.1.8.11. of Division B and opening in the direction of travel from the floor area to the exit stairway.

- (2) The vestibule referred to in Sentence (1) should have
- (a) a vent to the outdoors that has a net area of $10(0.023d + 0.00045a)$ m², where 'd' is the number of doors having a perimeter not more than 6 m that open into the vestibule, or if the perimeter of doors exceeds 6 m, the value 'd' is increased in direct proportion to the increase in the perimeter, and 'a' is the area in square metres of enclosing walls, floors and ceilings whose outer face is in contact with the outside air, except that where the outer face of a wall is in contact with the ground or fill, it is assumed that there is no leakage through that portion, and the value of 'a' is assumed to be zero, or
 - (b) equipment capable of maintaining a supply of air into the vestibule sufficient to ensure that the air pressure in the vestibule when the doors are closed is higher by at least 12 Pa than that in adjacent floor areas when the outdoor temperature is equal to the January design temperature on a 2.5% basis.

[3.2.6.5.(6)(b)] Electrical Cable Protection

R11.1 Electrical cables that provide continuous operation for 1 hour when subjected to the fire exposure/temperature curve of CAN/ULC-S101-14, "Fire Endurance Tests of Building Construction and Materials", do not need additional protection against exposure to fire.

[3.2.6.6.(1)] Venting to Aid Firefighting

- (1) The requirements of Sentence 3.2.6.6.(1) of Division B and of Measures H or I are met by incorporating in a floor area windows or wall panels as described in Sentence (2), by smoke shafts as described in Sentences (3) to (7) or by the use of building exhaust systems as described in Sentence (8).
- (2) Where windows or wall panels are used for venting as required in Sentence (1), they must
 - (a) be uniformly distributed along the exterior wall of each storey,
 - (b) have a total area of not less than one percent of the exterior wall area of each storey,
 - (c) be readily openable from the interior without the use of wrenches or keys,
 - (d) be readily identified from the interior, and from the exterior where they are accessible to firefighters, and
 - (e) be designed so that when opened they will not endanger persons outside the building during a fire.
- (3) Where one or more smoke shafts or vertical service spaces are used for venting to meet the requirements of Sentence (1), they must
 - (a) have an opening or openings into each storey with an aggregate area not less than that obtained from Table 1 for the height of the shaft, the area of the largest floor area served by the smoke shaft and the leakage characteristics of the shaft wall and closures obtained from Tables 2 and 3,
 - (b) have an aggregate unobstructed cross-sectional area equal to that provided in Clause (a), and
 - (c) be designed to comply with the requirements of Sentence (4).
- (4) Each smoke shaft or vertical service space described in Sentence (3) must
 - (a) be separated from the remainder of the building by a fire separation that has a fire-resistance rating at least equal to that required for the floor assembly through which it passes, or be designed as a chimney conforming to Part 6 of Division B, except that flue liners need not be provided,
 - (b) have an opening to the outdoors at the top that has an area not less than the cross-sectional area of the shaft which may be protected from the weather,
 - (c) terminate not less than 900 mm above the roof surface where it penetrates the roof, and
 - (d) contain no combustible material, fuel lines or services that are required for use in an emergency.

- (5) Each opening required by Clause (3)(a) must be located so that the top of the opening is not more than 250 mm below the ceiling, except that the opening may be above the ceiling if the ceiling freely allows passage of air and the opening into the smoke shaft is provided with a closure that
- (a) has a fire-protection rating conforming to Sentence 3.1.8.4.(2) of Division B, except that the temperature on the unexposed face of the closure is not more than 250°C after 30 min during the fire test and there is no combustible material within the distances described in Table 4, and except that paint or tightly-adhering paper covering not more than 1 mm thick shall be exempted from these requirements when applied to a noncombustible backing,
 - (b) can be opened from a remote location such as a stair shaft, the storey immediately below or the central alarm and control facility, and
 - (c) must not open automatically on any floor, other than the fire floor, when smoke or hot gases pass through the shaft.
- (6) Closures for openings described in Clause 4(b) are to be openable from the outside and will open automatically on a signal from a smoke detector in the shaft, by operation of the fire alarm system and when a closure required in Sentence (5) opens.
- (7) A smoke shaft opening referred to in Sentence (2) or (3) that is less than 1 070 mm above the floor must be protected by guards in conformance with Article 3.3.1.17. of Division B.
- (8) In a sprinklered building, the air handling system may be used for smoke venting provided
- (a) the system can maintain an exhaust to the outdoors at the rate of six air changes per hour from any floor area, and
 - (b) emergency power to the fans required by (a) is provided as described in Article 3.2.7.9. of Division B.
- r11.1** (9) Where a closure is required by Sentence (5), the leakage area between closure components and between damper and frame must be not more than 3 percent of the openable area of the damper.

Table 1
Minimum Size of Vent Openings into Smoke Shafts from Each Floor Area, m² (1),(3)

Floor Area, m ²	Leakage Area, % ⁽²⁾	Building Height, m								
		18	37	73	110	146	183	220	256	293
200	0	0.1	0.11	0.13	0.15	0.16	0.18	0.19	0.2	0.22
500		0.22	0.25	0.29	0.32	0.36	0.37	0.39	0.41	0.43
1 000		0.43	0.48	0.53	0.59	0.63	0.67	0.71	0.75	0.77
2 000		0.83	0.91	1.01	1.08	1.16	1.22	1.29	1.34	1.39
3 000		1.21	1.33	1.46	1.55	1.67	1.75	1.82	1.9	1.97
4 000		1.62	1.75	1.9	2.02	2.15	2.25	2.35	2.44	2.53
5 000		2.01	2.17	2.34	2.46	2.63	2.74	2.86	2.88	3.07
6 000		2.39	2.57	2.76	2.91	3.1	3.23	3.37	3.47	3.58
200	1	0.1	0.12	0.15	0.19	0.22	0.27	0.35	0.43	0.55
500		0.23	0.27	0.35	0.4	0.49	0.57	0.69	0.83	1.04
1 000		0.44	0.5	0.71	0.72	0.86	1.01	1.19	1.43	1.73
2 000		0.85	0.97	1.15	1.33	1.56	1.81	2.1	2.48	2.95
3 000		1.26	1.42	1.67	1.91	2.23	2.56	2.97	3.47	4.08
4 000		1.66	1.88	2.18	2.49	2.37	3.28	3.79	4.4	5.16
5 000		2.07	2.32	2.69	3.05	3.51	3.99	4.6	5.32	6.21
6 000		2.47	2.76	3.18	3.59	4.14	4.68	5.37	6.2	7.23
200	2	0.1	0.13	0.18	0.24	0.37	0.61	1.28	4.6	89.57
500		0.24	0.29	0.39	0.52	0.75	1.13	2.1	6.11	94.5
1 000		0.46	0.55	0.72	0.94	1.3	1.9	3.27	8.29	102.11
2 000		0.88	1.05	1.34	1.73	2.32	3.28	5.36	12.14	116.8
3 000		1.31	1.53	1.95	2.47	3.29	4.58	7.28	15.63	130.83
4 000		1.73	2.01	2.55	3.2	4.23	5.83	9.12	19.97	144.03
5 000		2.15	2.49	3.13	3.92	5.15	7.05	10.9	22.15	157.05
6 000		2.57	2.96	3.73	4.63	6.07	8.26	12.65	25.39	169.29
200	3	0.11	0.14	0.21	0.37	0.88	2.06			
500		0.25	0.31	0.47	0.76	1.58	9			
1 000		0.47	0.59	0.86	1.33	2.6	11.99			
2 000		0.91	1.12	1.6	2.41	4.47	17.46			
3 000		1.35	1.64	2.31	3.43	5.21	22.48			
4 000		1.79	2.17	3.02	4.43	7.91	27.29			
5 000		2.22	2.68	3.71	5.42	9.55	31.95			
6 000		2.65	3.2	4.4	6.39	11.18	36.47			
200	4	0.11	0.15	0.28	0.7	24.83				
500		0.25	0.34	0.58	1.33	29.18				
1 000		0.49	0.63	1.06	2.27	36.07				
2 000		0.95	1.21	1.97	3.99	48.56				
3 000		1.41	1.78	2.84	6.63	60.15				
4 000		1.86	2.34	3.7	7.22	71.15				
5 000		2.21	2.9	4.55	8.79	81.81				
6 000		2.75	3.46	5.4	10.33	90.05				
Column 1	2	3	4	5	6	7	8	9	10	11

Table 1 (Cont'd)
Minimum Size of Vent Openings into Smoke Shafts from Each Floor Area, m² (1),(3)

Floor Area, m ²	Leakage Area, % ⁽²⁾	Building Height, m								
		18	37	73	110	146	183	220	256	293
200	5	0.11	0.16	0.36	3.33					
500		0.28	0.36	0.76	5.09					
1 000		0.5	0.69	1.37	7.67					
2 000		0.99	1.31	2.54	12.35					
3 000		1.46	1.94	3.65	16.75					
4 000		1.92	2.55	4.75	20.99					
5 000		2.4	3.16	5.84	25.11					
6 000		2.87	3.74	6.92	29.11					
Column 1	2	3	4	5	6	7	8	9	10	11

Notes to Table 1:

- r11.1** (1) The minimum size of a vent opening into a smoke shaft is obtained from Table 1 and is dependent on the floor area and total leakage area of the smoke shaft walls and closures. This total leakage area may be estimated by adding the leakage areas for the shaft wall obtained from Table 2 and for the dampered openings obtained from Table 3 provided the cross-sectional area of the smoke shaft, the opening into the shaft and the opening to the outdoors at the top of the shaft are equal.
- r11.1** (2) Leakage area is the total of the leakage area of smoke shaft wall obtained from Table 2 and the leakage area of openings in smoke shafts obtained from Table 3.
- (3) The size of the vent opening refers to the free or unobstructed area of the opening.

Table 2
Leakage Area of Smoke Shaft Wall

Wall Construction	Leakage Area as % of Wall Area
Monolithic concrete	0.5
Masonry wall unplastered	1.5
Masonry wall plastered	0.5
Gypsum board on steel studs	1.0
Column 1	2

r11.1

Table 3
Leakage Area of Closures into Smoke Shaft

Type of Closure	Leakage Area as % of Closure Area ^{(1), (2)}
Curtain fire damper	2.5
Single-blade fire damper	3.5
Multi-blade fire damper	4.5
Column 1	2

Notes to Table 3:

- (1) Values include allowance for 0.5% leakage between frame and wall construction.
- (2) These leakage data contemplate clearances applicable to closures that have been tested in accordance with CAN/ULC-S112-10, "Fire Test of Fire-Damper Assemblies."

F11.1

Table 4
Minimum Distance from Closure to Combustible Material

Area of Closure, m ² (1)	Minimum Distance in Front of or Above Closure, m	Minimum Distance to the Sides or Below Closure, m
0.5	0.35	0.20
1.0	0.50	0.25
1.5	0.60	0.30
2.0	0.70	0.35
2.5 ⁽²⁾	0.80	0.40
Column 1	2	3

Notes to Table 4:

- (1) For closure areas between those given in Table 4, interpolation may be used to determine the appropriate distances.
 (2) For closure areas greater than 2.5 m², the minimum distance in front of or above the closure shall be one half of the square root of the closure area, and the minimum distance to the sides or below the closure shall be one quarter of the square root of the closure area.

[3.2.6.7.(1)] Protection of Central Control Room

The design of a room provided for a central alarm and control facility should be adequately protected from fire and smoke and take into account the nature and sensitivity of the electronic components of the equipment it contains. The room should also be ventilated with a supply of fresh air in order to maintain a clean environment. Adequate lighting is also required.

[3.2.6.7.(2)] Central Control Room Air Control

Depending on the method of mechanical venting and air control that is selected for the building, additional controls may be required at the central alarm and control facility. These additional controls include those with a capability of opening closures to vents in shafts, stopping air handling systems, and initiating mechanical air supply to stair shafts.

[3.2.6.9.(1)] Testing for Smoke Control

The efficiency of a smoke control system may be checked by measuring pressure differences and the directions of airflow around doors and through separating walls of compartments. A pressure meter can be used to measure pressure differences on either side of a door or partition. Where this is impracticable, a punk stick held near a crack will indicate the direction of airflow. Measurements of airflow may be taken on the intake side of supply fans or in supply ducts to determine whether the specified airflow is being provided. In general, airflow should be from the spaces which may be occupied for various lengths of time during a fire emergency (e.g., vestibules, stair shafts, and elevator hoistways) toward the space in which the fire is assumed to have occurred. Measurements may be taken at certain critical locations to check the overall efficiency of the smoke control system.

In buildings where protection is obtained by venting corridors or vestibules to the outdoors, inspection of the building to determine whether the requirements have been met should be sufficient. Where service shafts are vented to the outdoors at the top, a check may be made of the wall between the shaft and the uppermost occupied floor areas, to ensure that the direction of flow is from each floor area into the shaft, when the vent to the outside is open and the outdoor air temperature is significantly less than that indoors. Where mechanically pressurized vestibules are used, a check may be made to ensure that the pressure in each vestibule or area of refuge is greater than that in the adjacent floor areas at each floor level.

Doors to stair shafts, elevator hoistways and vestibules in locations subject to pressure differences that may interfere with normal opening should be checked when the outdoor temperature is near the January design temperature, with the air injection system operating and a number of windows open to the outdoors on each floor in turn.

Section 2 Scope of Measures for Fire Safety in Existing High Buildings

This Supplementary Standard includes a number of detailed measures that may be incorporated in a building in order to comply with the requirements relating to control of smoke for existing buildings. It is not the intention to exclude other means of attaining the same objectives. Where smoke control methods other than those described in this Supplementary Standard are developed, they may be based on the information in Appendix B of this Supplementary Standard.

Smoke control measures appropriate to existing buildings vary depending on the height and occupancy of a building. In a sprinklered building, the requirements for control of smoke movement are minimal (see Measure A, Section 3). In very tall buildings, limits are placed on the penetration of smoke into exit stairs, elevators for firefighters and all floor areas other than the one on which fire occurs. Such limits are achieved by Measures B, D, F, H and I in Section 3. In certain buildings of lesser height and limited population, exit stairs and elevators for firefighters are protected and smoke may be expected to enter upper floor areas. This situation applies where Measures C, E, G and J, described in Section 3, are employed. In other buildings, the spread of smoke into shafts and floor areas is accepted, but areas of refuge are provided

that are maintained smoke free, that can be reached by all people in the building within a few minutes and that are linked to outdoors by safe means of egress. They are described in Measures K and L in Section 3.

Where Measures A, B, D, F, H and I in Section 3 are applied, it is assumed that in the event of fire occupants of the floor on which the fire occurs will leave by exit stairs immediately following the sounding of a fire alarm, and that occupants of the floor immediately above the floor on which the fire occurs will be advised to leave by the first fire department officer on the scene or other person assigned this responsibility. Occupants of all other floors may remain on their floors unless otherwise directed.

Where Measures C, E, G and J in Section 3 are applied, it is assumed that occupants of all floors will move immediately into the stair shafts and will then proceed slowly to the outdoors following the sounding of a general fire alarm.

Where Measure K in Section 3 is applied (i.e. the building is divided vertically into two zones), it is assumed that occupants of the floor on which the fire originates will leave by exit stairs, and that the occupants of all other floors in the zone in which the fire is discovered will move through vestibules or bridges to floor areas on the same level in the fire-free smoke control region immediately following the sounding of a fire alarm. Occupants may remain in these areas of refuge until further directed by the fire department officer.

Where Measure L in Section 3 is applied, it is assumed that occupants of the floor on which the fire originates will leave by the exit stairs, and that occupants of all other floors will move by corridors or stairs to areas of refuge that are distributed throughout the building immediately following the sounding of the fire alarm. Occupants may remain in these areas of refuge until otherwise directed.

In a residential building where reliance is placed on balconies as places of refuge from smoke, as described in Measure M in Section 3, occupants may remain in their suites when a general fire alarm is given, but should be prepared to move on to their balconies if conditions in the suite should become untenable.

It is assumed that the cumulative population of storeys below grade divided by 1.8 times the width in metres of all exit stairs at the storey under consideration will not exceed the 300 limit referred to in Article 3.2.6.1. of Division B, and that occupants of storeys below grade will evacuate the building by the stair shafts immediately after the discovery of a fire in a storey below grade.

It is also important that firefighters are provided with a smoke-free access to fire floors below grade. Measures A, B, C, D, E, F, G, L and M include provisions designed to separate the exit stairs serving storeys above grade from those serving storeys below grade, and to limit entry of smoke into these shafts. Elevator shafts and service shafts are required to be provided with a separation near grade, or be designed to limit their functioning as paths of smoke movement into upper floor areas. In Measures H, I and J, no special precautions are necessary to protect shafts in storeys below grade, because the system of pressurization plus venting of the fire floor protects all shafts, whether or not these penetrate storeys below grade. In Measure K, the separation into two zones is maintained in storeys below grade. Smoke-free access will thus be available to any floor on which the fire occurs.

Synopsis of Measures for Fire Safety in High Buildings

r11.1 Each of the measures is illustrated by a sketch with notes describing the applicable conditions (Figures 1 to 18A). These sketches are intended as a guide to the detailed requirements and as an aid to finding the relative clauses, but they are not intended to limit in any way the scope of the detailed provisions which in general provide a wider range of choice than can be shown in the sketches and notes. A summary of requirements applicable to all buildings, regardless of the measure being used, is given in the following paragraph.

Requirements Common to all Measures for Fire Safety in High Buildings

- (1) Elevators controlled by keyed switch (Article 3.2.6.4. of Division B).
- (2) Elevator for firefighters required (Article 3.2.6.5. of Division B).
- (3) Means of venting each floor area to outdoors by smoke shaft, windows or building exhaust system (Article 3.2.6.6. of Division B).
- (4) Certain floor areas in the building to be sprinklered (Articles 3.2.1.5. and 3.2.2.15. of Division B).
- (5) Limits on flame-spread rating and smoke developed classification for interior finish materials in certain locations (Article 3.1.13.7. of Division B).
- (6) Central alarm and control facility required (Article 3.2.6.7. of Division B).
- (7) Voice communication system required if building is more than 36 m high (Article 3.2.6.8. of Division B).
- (8) Fire protection required for electrical feeders to emergency equipment (Article 3.2.7.10. of Division B).
- (9) Power to operate emergency lighting, fire alarm and voice communication systems (Articles 3.2.7.4. and 3.2.7.8. of Division B).
- (10) Emergency power to operate elevators required if building is more than 36 m high (Article 3.2.7.9. of Division B).

Measure A Fully Sprinklered Building

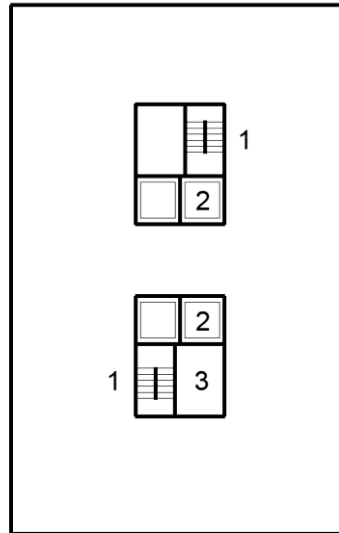


Figure 1
Typical floor plan, Measure A

Measure A satisfies 3.2.6.2.(1) provision (6) as described in Section 1 for existing sprinklered buildings of any major occupancy classification.

No limit on height.

All floor areas sprinklered (3.2.6.2.(1) provision (6) as described in Section 1).

Limits on flame-spread ratings and smoke developed classifications described in Sentence 3.1.13.7.(1) of Division B are relaxed (Sentence 3.1.13.7.(2) of Division B).

1. Door to outdoors in each stair shaft held open during a fire emergency (3A(2))*
Stair shaft serving floors below the lowest exit level is separate from stair shaft serving floors above that storey (3A(3)).
Stair shaft serving floors below the lowest exit level is pressurized during a fire emergency (3A(3)).
2. Elevator shaft terminates not lower than the first floor below the lowest exit storey or has elevator vestibules in every storey below the lowest exit storey (3A(5)).
3. Vertical service spaces, other than elevator shafts, provided with firestops at the first floor below the lowest exit storey or vented to outdoors at top during a fire emergency (3A(6)).
Air moving fans are stopped during a fire emergency in a system that serves more than two storeys (3.2.6.2.(1) provision (6)(d) as described in Section 1).

* First number indicates Section number. Letter indicates Measure. Last number indicates number of Sentence in that Measure.

Measure B Open Corridor Access to Stairs and Elevators (including restrictions on movement of smoke from floor to floor)

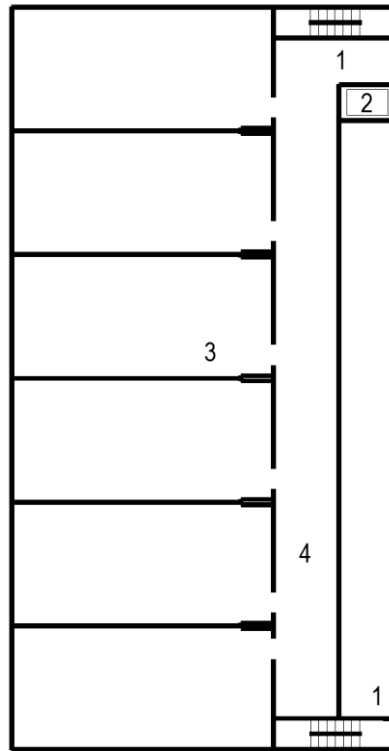


Figure 2
Typical floor plan, Measure B

Measure B satisfies 3.2.6.2.(6) provisions (2) to (4) as described in Section 1 for any major occupancy classification. No limit on height.

1. Stair shaft serving floors below the lowest exit level is separate from stair shaft serving floors above that storey (3B(3)).*
Stair shaft serving floors below the lowest exit level is pressurized during a fire emergency (3B(3)).
2. Elevator shaft terminates not lower than the first floor below the lowest exit storey or has elevator vestibules in every storey below the lowest exit storey (3B(4)).
3. Vertical service spaces, other than elevator shafts, provided with firestops at the first floor below the lowest exit storey and at intervals of not more than five storeys or vented to outdoors at top during a fire emergency (3B(5)).
4. Open corridor or balcony providing access to stairs and elevator for firefighters (3B(2)).
Elevator shaft and stair shaft heating restrictions.
Air moving fans are stopped during a fire emergency in a system that serves more than two storeys (3B(6)).
Certain dampers close in air handling ducts during a fire emergency (3B(8)).

* First number indicates Section number. Letter indicates Measure. Last number indicates number of Sentence in that Measure.

Measure C Open Corridor Access to Stairs and Elevators (no additional restrictions on movement of smoke from floor to floor)

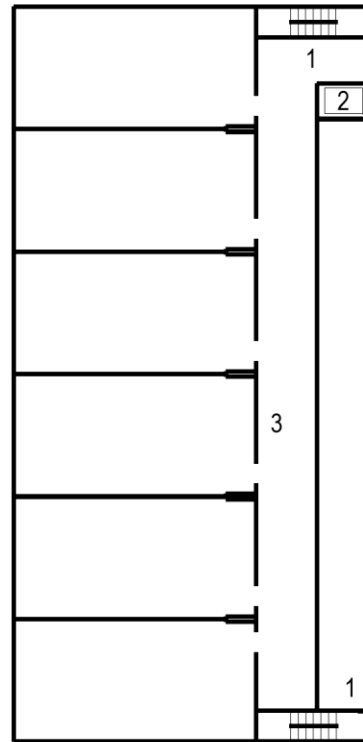


Figure 3
Typical floor plan, Measure C

Measure C satisfies 3.2.6.2.(6) provision (6) as described in Section 1 for Group A, C, D, E or F major occupancy classification.

Limit on population (3.2.6.2.(6) provision (6) as described in Section 1).

Limited to buildings not more than 75 m high (3.2.6.2.(6) provision (6) as described in Section 1).

1. Stair shaft serving floors below the lowest exit level is separate from stair shaft serving floors above that storey (3C(3)).*
Stair shaft serving floors below the lowest exit level is pressurized during a fire emergency (3C(3)).
2. Elevator shaft terminates not lower than the first floor below the lowest exit storey or has elevator vestibules in every storey below the lowest exit storey (3C(4)).
3. Open corridor or balcony providing access to stairs and elevator for firefighters (3C(2)).
Elevator shaft and stair shaft heating restrictions.
Air moving fans are stopped during a fire emergency in a system that serves more than two storeys (3C(5)).

* First number indicates Section number. Letter indicates Measure. Last number indicates number of Sentence in that Measure.

Measure D Protected Vestibule Access to Stairs and Elevators (including restrictions on movement of smoke from floor to floor)

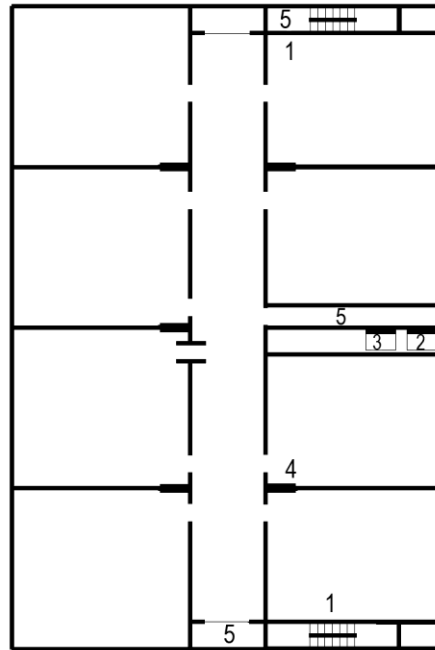


Figure 4
Typical floor plan, Measure D

Measure D satisfies 3.2.6.2.(6) provisions (2) to (4) as described in Section 1 in existing buildings of any major occupancy classification.

No limit on height.

1. Door to outdoors in each stair shaft held open during a fire emergency (3D(7)).*
Stair shaft serving floors below the lowest exit level is separate from stair shaft serving floors above that level (3D(8)).
Stair shaft serving floors below the lowest exit level is pressurized during a fire emergency (3D(8)).
2. Elevator shaft terminates not lower than the first floor below the lowest exit storey or has elevator vestibules in every storey below the lowest exit storey (3D(13)).
3. Shaft containing an elevator for firefighters is provided with vent to outdoors at bottom during a fire emergency if the vestibule protection is by pressurization (3D(9)).
4. Vertical service spaces, other than elevator shafts, provided with firestops at the first floor below the lowest exit storey and at intervals of not more than five storeys or vented to outdoors at top during a fire emergency (3D(11)).
5. Vestibule vented to outdoors during a fire emergency or pressurized (3D(5)).
Vents to vestibules openable from central control facility if building is more than 36 m high (3D(6)).
Air moving fans are stopped during a fire emergency in a system that serves more than two storeys (3D(14)).
Certain dampers close in air handling ducts during a fire emergency (3D(15)).

* First number indicates Section number. Letter indicates Measure. Last number indicates number of Sentence in that Measure.

Measure E Protected Vestibule Access to Stairs and Elevators (no additional restrictions on movement of smoke from floor to floor)

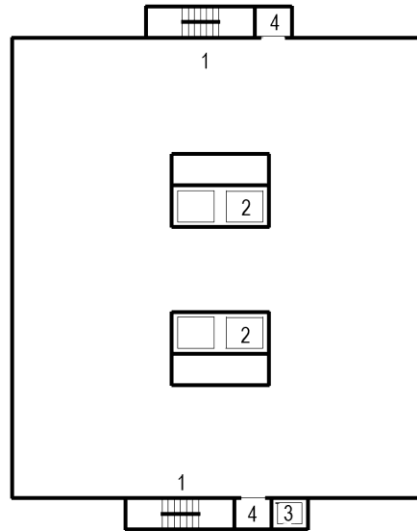


Figure 5
Typical floor plan, Measure E

Measure E satisfies 3.2.6.2.(6) provision (6) as described in Section 1 for Group A, C, D, E or F major occupancy classification.

Limit on population (3.2.6.2.(6) provision (6) as described in Section 1).

Limited to buildings not more than 75 m high (3.2.6.2.(6) provision (6) as described in Section 1).

1. Door to outdoors in each stair shaft held open during a fire emergency (3E(6)).*
Stair shaft serving floors below the lowest exit level is separate from stair shaft serving floors above that level (3E(7)).
Stair shaft serving floors below the lowest exit level is pressurized during a fire emergency (3E(7)).
2. Elevator shaft terminates not lower than the first floor below the lowest exit storey or has elevator vestibules in every storey below the lowest exit storey (3E(10)).
No special protection against smoke for elevator shafts or vertical service spaces other than a shaft containing an elevator for firefighters.
3. Shaft containing an elevator for firefighters is provided with vent to outdoors at bottom during a fire emergency (3E(8)).
4. Vestibule vented to outdoors during a fire emergency or pressurized (3E(4)).
Vents to vestibules openable from central control facility if building is more than 36 m high (3E(5)).
Air moving fans are stopped during a fire emergency in a system that serves more than two storeys (3E(11)).

* First number indicates Section number. Letter indicates Measure. Last number indicates number of Sentence in that Measure.

Measure F Pressurized Stair Shafts and Elevator Shafts (including restrictions on movement of smoke from floor to floor)

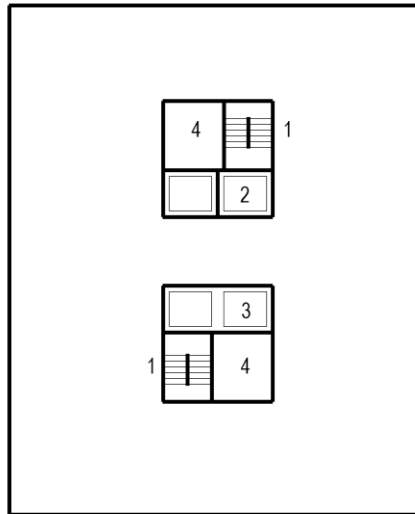


Figure 6
Typical floor plan, Measure F

Measure F satisfies 3.2.6.2.(6) provisions (2) to (4) as described in Section 1 in existing buildings of any major occupancy classification.

No limit on height.

1. Door to outdoors in each stair shaft held open during a fire emergency (3F(2)).*
Stair shaft pressurized during a fire emergency (3F(2)).
Stair shaft serving floors below the lowest exit level is separate from stair shaft serving floors above that level (3F(3)).
Stair shaft serving floors below the lowest exit level is pressurized during a fire emergency (3F(3)).
2. Shaft containing an elevator for firefighters is pressurized during a fire emergency (3F(4)).
3. Vertical service spaces, other than elevator shafts, provided with firestops at the first floor below the lowest exit storey and at intervals of not more than five storeys or vented to outdoors at top during a fire emergency (3F(7)).
Air moving fans are stopped during a fire emergency in a system that serves more than two storeys (3F(11)).
Certain dampers in air-handling ducts close during a fire emergency (3F(12)).

* First number indicates Section number. Letter indicates Measure. Last number indicates number of Sentence in that Measure.

Measure G Pressurized Stair Shafts and Elevator Shafts (no additional restrictions on movement of smoke from floor to floor)

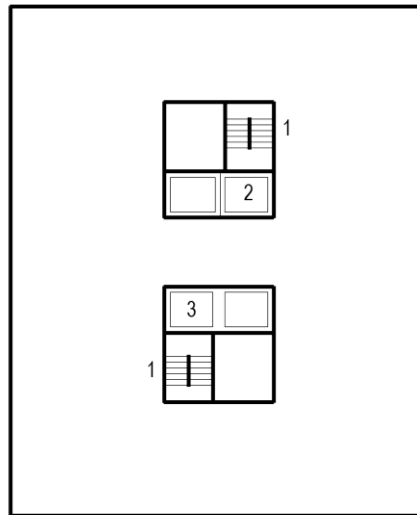


Figure 7
Typical floor plan, Measure G

Measure G satisfies 3.2.6.2.(6) provision (6) as described in section 1 for Group A, C, D, E or F major occupancy classification.

Limit on population (3.2.6.2.(6) provision (6) as described in section 1).

Limited to buildings not more than 75 m high (3.2.6.2.(6) provision (6) as described in section 1).

1. Door to outdoors in each stair shaft held open during a fire emergency (3G(2)).*
Stair shaft pressurized during a fire emergency (3G(2)).
Stair shaft serving floors below the lowest exit level is separate from stair shaft serving floors above that level (3G(3)).
Stair shaft serving floors below the lowest exit level is pressurized during a fire emergency (3G(3)).
2. Shaft containing an elevator for firefighters is pressurized during a fire emergency (3G(4)).
3. No special protection against smoke for elevator shafts or vertical service spaces other than a shaft containing an elevator for firefighters.
Air moving fans are stopped during a fire emergency in a system that serves more than two storeys (3G(7)).

* First number indicates Section number. Letter indicates Measure. Last number indicates number of Sentence in that Measure.

Measure H Building Fully Pressurized

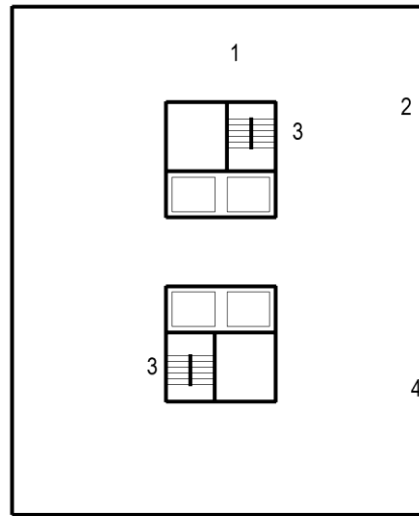


Figure 8
Typical floor plan, Measure H

Measure H satisfies 3.2.6.2.(6) provisions (2) to (4) as described in Section 1 in existing buildings of any major occupancy classification.

No limit on height

1. All floor areas pressurized during a fire emergency (3H(2)).*
Provision for modulating air supply for building pressurization during warm weather (3H(4)).
2. Fire floor provided with means of venting to outdoors by smoke shaft or windows (3H(7)).
3. A proportion of air for building pressurization directed into stair shafts (3H(2)).
Doors to outdoors in stair shafts not held open during a fire emergency (3H(5)).
4. Except as required for venting, all openings in perimeter walls and roof are kept closed during a fire emergency (3H(5)).
Except as required for pressurization, air moving fans are stopped during a fire emergency in a system that serves more than two storeys (3H(4)).
Certain dampers in air handling ducts are closed during a fire emergency (3H(6)).

* First number indicates Section number. Letter indicates Measure. Last number indicates number of Sentence in that Measure.

Measure I Partially Pressurized Building (including restrictions on movement of smoke from floor to floor outside core)

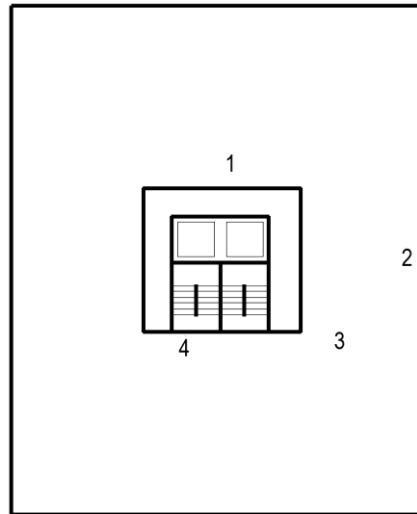


Figure 9
Typical floor plan, Measure I

Measure I satisfies 3.2.6.2.(6) provisions (2) to (4) as described in Section 1 in existing buildings of any major occupancy classification.

No limit on height.

1. Enclosing wall of core is a fire separation with self-closing doors.
Central core is pressurized during a fire emergency (3I(2)).*
All openings in perimeter walls and roof of core kept closed during a fire emergency (3I(3)).
2. Fire compartment is vented to outdoors during a fire emergency by smoke shaft or windows (3I(4)).
3. Vertical service spaces, other than elevator shafts, outside core provided with firestops at the level of the first floor below the lowest exit storey and at intervals of not more than five storeys or vented to outdoors at the top during a fire emergency (3I(6)).
4. Doors to outdoors in stair shafts not held open during a fire emergency except as required for pressurizing the core (3I(3)).
Air moving fans are stopped during a fire emergency in a system that serves more than two storeys (3I(7)).
Certain dampers in air handling ducts are closed during a fire emergency (3I(8)).

* First number indicates Section number. Letter indicates Measure. Last number indicates number of Sentence in that Measure.

Measure J Partially Pressurized Building (no additional restrictions on movement of smoke from floor to floor outside core)

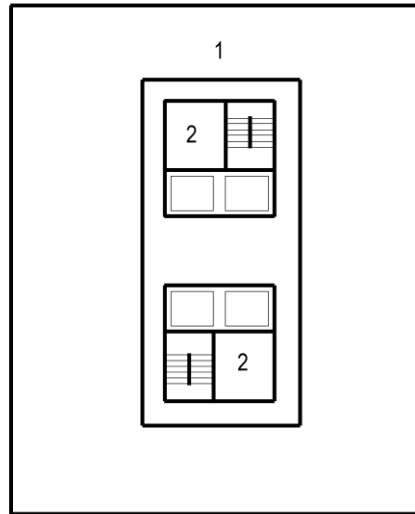


Figure 10
Typical floor plan, Measure J

Measure J satisfies 3.2.6.2.(6) provision (6) as described in Section 1 for Group A, C, D, E or F major occupancy classification.

Limit on population (3.2.6.2.(6) provision (6) as described in Section 1).

Limited to buildings not more than 75 m high (3.2.6.2.(6) provision (6) as described in Section 1).

1. Enclosing wall of core is a fire separation with self-closing doors.
Central core is pressurized during a fire emergency (3J(2)).*
All openings in perimeter walls and roof of core are kept closed during a fire emergency (3J(3)).
2. Doors to outdoors in stair shafts not held open during a fire emergency (3J(3)).
Air moving fans are stopped during a fire emergency in a system that serves more than two storeys (3J(4))

* First number indicates Section number. Letter indicates Measure. Last number indicates number of Sentence in that Measure.

Measure K Vertically Divided Buildings (with spatial separation)

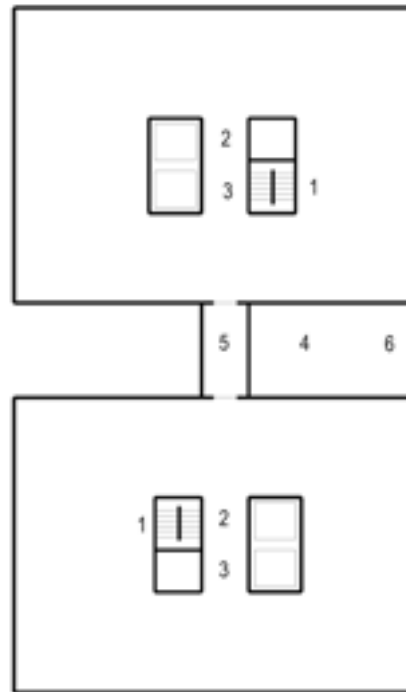


Figure 11
Typical floor plan, Measure K

Measure K satisfies 3.2.6.2.(6) provision (5) as described in Section 1 for buildings of Group A, C, D, E or F major occupancy classification.

No limit on height.

1. Door to outdoors in each stair shaft held open during a fire emergency (3K(13)).*
2. One elevator for fire fighters and one stairshaft in each smoke control region (3K(4)).
3. If bridges do not occur at each storey, two stairshafts are required in each smoke control region (Sentence 3.4.2.1. of Division B).
4. Building designed as two smoke control regions with spatial separation between (3K(2)).
5. Bridges at intervals of not more than five storeys, except that in buildings of Group C major occupancy more than 75 m high, the bridge is at each storey (3K(3)).
Bridges vented to outdoors or pressurized during a fire emergency (3K(11)).
6. Fire separation in storeys below grade to maintain separation between smoke control regions (3K(15)). Air moving fans are stopped during a fire emergency in a system that serves more than two storeys (3K(14)).

* First number indicates Section number. Letter indicates Measure. Last number indicates number of Sentence in that Measure.

Measure K Vertically Divided Buildings (with fire separation)

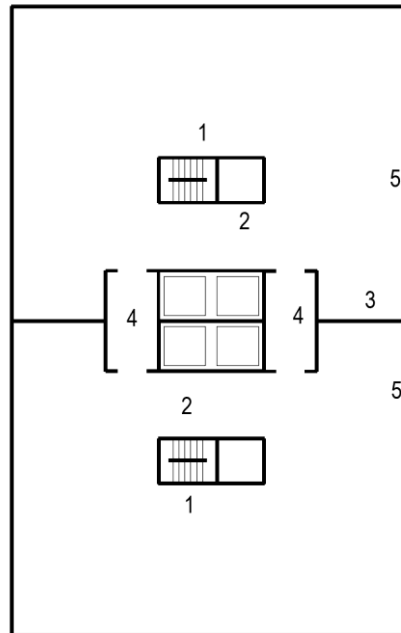


Figure 12
Typical floor plan, Measure K

Measure K satisfies 3.2.6.2.(6) provision (5) as described in Section 1 for buildings of Group A, C, D, E or F major occupancy classification.

No limit on height.

1. Door to outdoors in each stair shaft held open during a fire emergency (3K(13)).*
2. One elevator for firefighters and one stair shaft in each smoke control region (3K(4)).
If vestibules do not occur at each storey, two stair shafts are required in each smoke control region (Sentence 3.4.2.1. of Division B).
3. Building designed as two smoke control regions with fire separation between (3K(2)).
Fire separation in storeys below grade to maintain separation between smoke control regions (3K(15)).
4. Vestibule at intervals of not more than five storeys, except that in the case of buildings of Group C major occupancy more than 75 m high, the vestibule is at each storey (3K(3)).
Vestibules vented to outdoors or pressurized during a fire emergency (3K(11)).
5. Vent to outdoors in each smoke control region on floors below mid height of building (3K(12)).
Air moving fans are stopped during a fire emergency in a system that serves more than two storeys (3K(14)).

* First number indicates Section number. Letter indicates Measure. Last number indicates number of Sentence in that Measure.

Measure L Areas of Refuge (duplicate groups of areas of refuge at every fifth storey except as required in item 5)

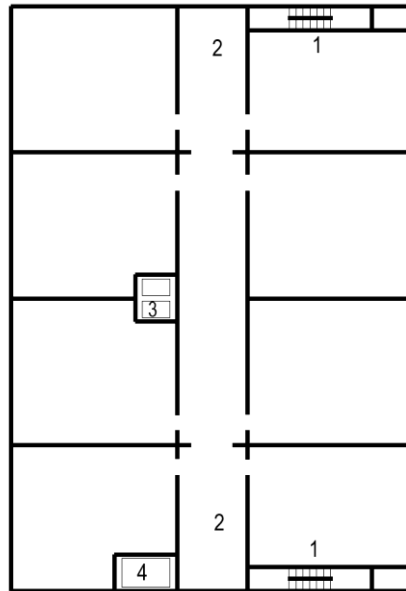


Figure 13
Typical floor plan, Measure L

Measure L satisfies 3.2.6.2.(6) provision (5) as described in Section 1 for buildings of Group A, C, D, E or F major occupancy classification.

No limit on height.

1. Stair shaft and shaft containing an elevator for firefighters protected by area of refuge or vestibule (3L(11)).*
Door to outdoors in each stair shaft held open during a fire emergency (3L(14)).
Stair shaft serving floors below the lowest exit level is separate from stair shaft serving floors above that storey (3L(15)).
Stair shaft serving floors below the lowest exit level is pressurized during a fire emergency (3L(15)).
2. Stair shaft and shaft containing an elevator for firefighters is protected at intermediate floors by pressurized vestibules (3L(11)).
3. Shaft containing an elevator for firefighters terminates not lower than the first floor below the lowest exit storey or has elevator vestibules in every storey below the lowest exit storey (3L(13)).
Shaft containing an elevator for firefighters provided with vent to outdoors at bottom during a fire emergency (3L(16)).
4. No special protection against smoke for elevator shafts or vertical service spaces other than a shaft containing an elevator for firefighters.
5. Two areas of refuge on each fifth floor pressurized during a fire emergency (3L(10)), or areas of refuge staggered on intermediate storeys (see Figure 15), except that in buildings of Group C major occupancy more than 75 m high the areas of refuge shall be located on each storey.
Air moving fans are stopped during a fire emergency in a system that serves more than two storeys (3L(18)).

* First number indicates Section number. Letter indicates Measure. Last number indicates number of Sentence in that Measure.

Measure L Areas of Refuge (areas of refuge located in pairs)

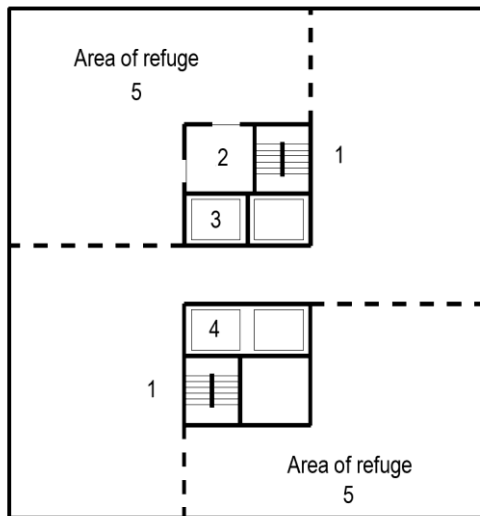


Figure 14
Typical floor plan, Measure L

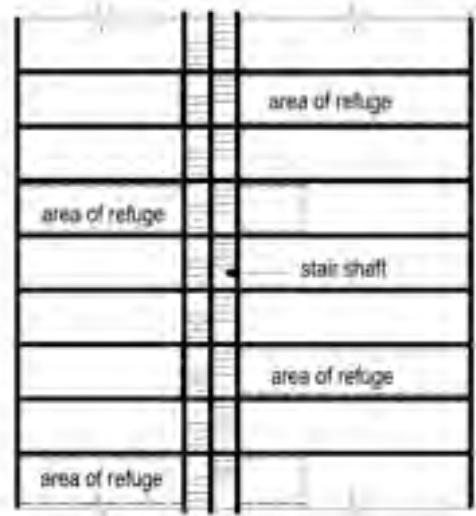


Figure 15
Typical cross section showing areas of refuge
on intermediate floors

Measure L satisfies 3.2.6.2.(6) provision (5) as described in Section 1 for buildings of Group A, C, D, E or F major occupancy classification.

No limit on height.

1. Stair shaft and shaft containing an elevator for firefighters protected by area of refuge or vestibule (3L(11)).*
Door to outdoors in each stair shaft held open during a fire emergency (3L(14)).
Stair shaft serving floors below the lowest exit level is separate from stair shaft serving floors above that storey (3L(15)).
Stair shaft serving floors below the lowest exit level is pressurized during a fire emergency (3L(15)).
2. Two areas of refuge are pressurized during a fire emergency (see Figure 14 for area of refuge every fifth storey), except that in buildings of Group C major occupancy more than 75 m high, the areas of refuge are located on each storey (3L(10)).
3. No special protection against smoke for elevator shafts or vertical service spaces other than a shaft containing an elevator for firefighters.
4. Shaft containing an elevator for firefighters terminates not lower than the first floor below the lowest exit storey or has elevator vestibules in every storey below the lowest exit storey (3L(13)).
Shaft containing an elevator for firefighters is provided with vent to outdoors at bottom during a fire emergency (3L(16))
Air moving fans are stopped during a fire emergency in a system that serves more than two storeys (3L(18)).

* First number indicates Section number. Letter indicates Measure. Last number indicates number of Sentence in that Measure.

Measure M Building with Balconies

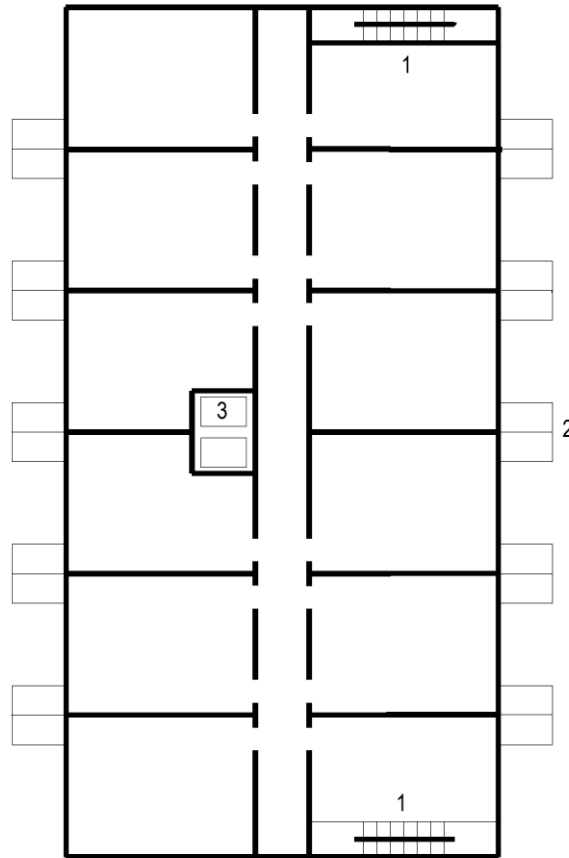


Figure 16
Typical floor plan, Measure M

Measure M satisfies 3.2.6.2.(6) provision (7) as described in Section 1 for existing buildings of Group C major occupancy classification.

1. Door to outdoors in each stair shaft held open during a fire emergency (3M(2)).*
Stair shaft serving floors below the lowest exit level is separate from stair shaft serving floors above that level (3M(3)).
Stair shaft serving floors below the lowest exit level is pressurized during a fire emergency (3M(3)).
2. Each suite is provided with a balcony (3.2.6.2.(6) provision (7) as described in Section 1).
3. Elevator shaft terminates not lower than the first floor below the lowest exit storey or has elevator vestibules in every storey below the lowest exit storey (3M(4)).
Air moving fans are stopped during a fire emergency in a system that serves more than two storeys (3M(5)).

* First number indicates Section number. Letter indicates Measure. Last number indicates number of Sentence in that Measure.

Measure N Connected Buildings

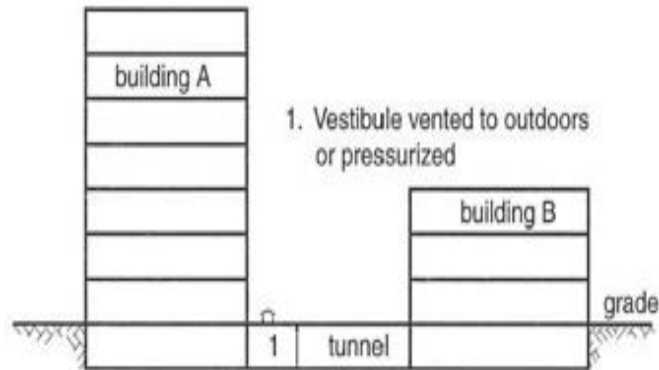
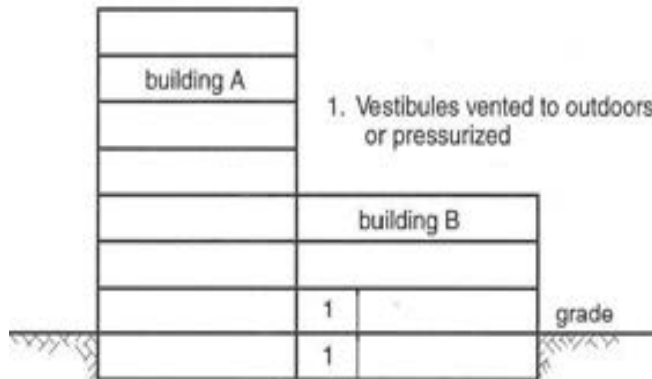
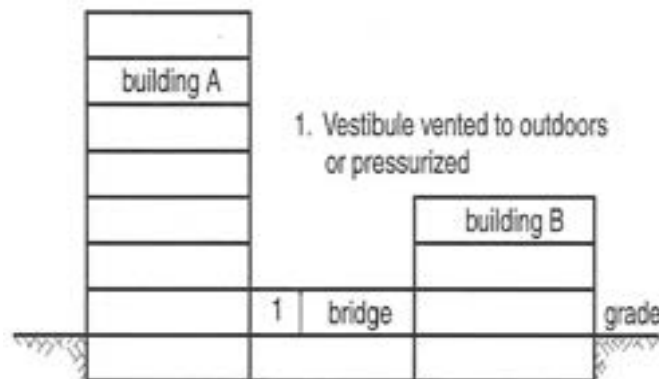


Figure 17
Section through buildings linked by underground tunnel



r11.1

Figure 18
Section through buildings joined at firewall



r11.1

Figure 18A
Section through buildings connected by a bridge

Measure N satisfies Article 3.2.6.3. of Division B for existing connected buildings.

Section 3 Measures for Life Safety in Existing High Buildings

Measure A Fully Sprinklered Buildings

General

The steps described in this Measure amount to an adequate smoke control measure, satisfying the requirements for existing sprinklered buildings. Reliance is placed on the full sprinkler installation to limit fire spread and consequently, the generation of smoke.

Some additional protection of exit stairs is afforded by the provision of an opening to the outdoors at the foot of the stair shaft. In cold weather, when stack action is likely to be most significant, this measure may give a general increase in air pressure in the stair shaft, thus restricting entry of smoke.

In this Measure is included the requirement that elevator shafts and service shafts should not be continuous from above to below grade, except when vestibules are provided at elevator doors in below grade storeys.

Where Measure A is adopted and a fire is detected by an automatic device or a manual pull station is actuated, it is intended that a fire alarm will sound on all floors simultaneously, and that the occupants of the fire floor will walk downstairs to the street floor or to a safe intermediate floor area. Occupants of other floors may remain where they are until advised to evacuate by the person operating the central alarm and control facility.

Measure A

- (1) The requirements for existing sprinklered buildings may be met by incorporating the requirements in Sentences (2) to (8).
- (2) A stairway serving storeys above the lowest exit level has a vent or door to the outdoors at or near the bottom of the stair shaft, as described in Sentence (4).
- (3) A stairway serving floors below the lowest exit level
 - (a) has a vent or door to the outdoors at or near the top of the stair shaft that has an openable area of not less than 0.1 m² for each storey served by the stairway, less 0.01 m² for each weatherstripped door and 0.02 m² for each non-weatherstripped door opening into the stair shaft,
 - (b) is enclosed in a shaft that does not pass through the floor above the lowest exit level and is separate from a shaft that contains a stairway serving upper storeys, or is enclosed in a shaft that contains a stairway serving upper storeys, but is separated from that stairway at the lowest exit level by a fire separation having a fire-resistance rating not less than that required for the shaft enclosure, and
 - (c) is provided with equipment capable of maintaining a flow of air introduced at or near the bottom of the stair shaft, at a rate equal to 0.47 m³/s for each storey served by the stairway.
- (4) A stair shaft required to be vented to the outdoors by Sentence (2) or by other provisions in this Supplementary Standard is provided with a vent or door that
 - (a) has an openable area of 0.05 m² for every door between the stair shaft and a floor area, but not less than 1.8 m²,
 - (b) opens directly to the outdoors or into a vestibule or exit corridor that has a similar opening to the outdoors, and
 - (c) has a door or closure that is openable manually and can remain in this open position during a fire emergency.
- (5) Any elevator shaft that passes through the floor above the lowest exit storey does not penetrate the floor of the storey immediately below the lowest exit storey, except where there is a vestibule between the shaft and each floor area below grade as described in Sentence (3) of Measure D.

- (6) A vertical service space, other than an elevator shaft, that passes through the floor above the lowest exit storey, is provided with a tight-fitting noncombustible seal or fire stop at the floor level of the storey immediately below that storey, except where the vertical service space is vented to the outdoors at the top as described in Sentence (10) of Measure F.
- (7) A supply of air required by Sentence (3) is carried in ducts as described in Sentence (13) of Measure F.
- (8) The central control facility required by Article 3.2.6.7. of Division B is provided with additional controls capable of
 - (a) opening closures to vents in shafts that may be required by Sentence (6),
 - (b) stopping air handling systems as required by provisions for existing sprinklered buildings, and
 - (c) initiating the mechanical air supply to stair shafts as may be required in Sentence (3).

Measures B and C Open Corridor Access to Stairs and Elevators

General

Measures B and C can be applied to a building where habitable floor areas are approached along access ways open to the outdoors.

Each corridor that provides access to stairs or elevators is permanently open to the outside as shown in Figures 2 and 19. The situation is illustrated by the pressure characteristic diagram shown in Figure 20. Air flow through openings that may exist in floors is likely to be more pronounced than with other smoke control methods because of the reduction in the influence of vertical shafts, so it is desirable that openings through the floor-ceiling assembly be minimized. This should not, however, present an immediate smoke problem except on the floor directly above the floor where a fire occurs.

Measure C is the same as Measure B, except that no steps are taken to limit smoke movement into upper storeys through vertical service spaces or shafts in Measure C.

Where shafts enclosing plumbing and electrical services penetrate floor spaces and a decision has been made to use Measure B for control of smoke movement, these shafts should be sealed at least at every fifth storey at a horizontal fire separation and at the floor immediately below the lowest exit storey or have vents to the outside at the top. In the latter case there is still some possibility that smoke may pass into the uppermost floor because the air pressures in these floor areas are in the same range as the outside pressures. It is therefore important that any leakage areas in the enclosing walls between floor areas and shaft be kept to a minimum.

In order to avoid creation of pressures that may interfere with the opening of doors to stair shafts and elevator shafts, it is recommended that the building heating system be so designed that temperatures in heated stair shafts and elevator shafts be not more than 12°C above outside air temperature.

Where Measure B is adopted and a fire is detected by an automatic device or a manual pull station is actuated, it is intended that a fire alarm will sound on all floors simultaneously, and that the occupants of the fire floor will walk down stairs to a safe floor area. In buildings more than 36 m high, occupants of other floors may remain until advised to evacuate by the person operating the central alarm and control facility.

Where Measure C is adopted, and a fire is detected by an automatic device or a manual pull station is actuated, it is intended that a fire alarm will sound on all floors simultaneously, and that occupants of all floors will walk down stairs to the street floor or to a safe intermediate floor area.

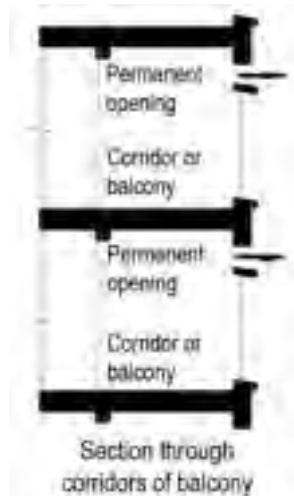


Figure 19 Illustration of Measures B and C designs

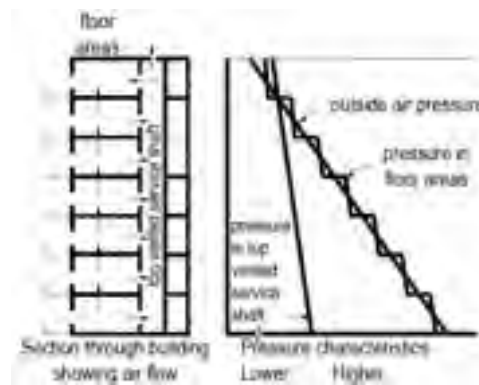


Figure 20 Pressure characteristics in a Measure B design

Measure B (including restriction on the movement of smoke from floor to floor)

- (1) The requirements of measures to limit smoke movement in existing buildings may be met by incorporating the requirements in Sentences (2) to (9).
- (2) All public corridors leading to the required exit stairs and elevators for firefighters from every floor area on a floor above the lowest exit storey are provided with permanent openings to the outdoors that
 - (a) are distributed along the length of the corridor,
 - (b) have the top of the opening not more than 250 mm below the ceiling of the corridor, and
 - (c) have an aggregate open area that is not less than 10 percent of the floor area of the corridor or 1 m², whichever is greater.
- (3) A stairway serving storeys below the lowest exit level is protected as described in Sentence (3) of Measure A.
- (4) Any elevator shaft that passes through the floor above the lowest exit storey does not penetrate the floor of the storey immediately below the lowest exit storey except where there is a vestibule between the elevator door or doors and each floor area below grade as described in Sentence (3) of Measure D.

- (5) A vertical service space, other than an elevator shaft, within a heated floor area is provided with
 - (a) tight-fitting noncombustible fire stops located at the level of the floor immediately below the lowest exit storey and at the level of certain other floors that are fire separations provided the space between fire stops is not more than five storeys, or
 - (b) a vent to the outdoors as described in Sentence (10) of Measure F.
- (6) Except for exhaust from kitchens, washrooms and bathrooms in dwelling units, air moving fans are stopped during a fire emergency in an air handling system that serves more than two storeys.
- (7) Supply, return and exhaust ducts more than 0.013 m² in cross-sectional area at the point of entry to a vertical service space in an air handling system that is required to shut down by the provisions of Sentence (6) are provided with dampers that will close when the air moving fans are stopped.
- (8) Where a supply of air is required by the provisions of Sentence (3), it is carried in ducts as described in Sentence (13) of Measure F.
- (9) The central alarm and control facility required by Article 3.2.6.7. of Division B is provided with additional controls that are capable of
 - (a) stopping the air handling systems and closing dampers as required by Sentences (6) and (7),
 - (b) opening closures to vents in vertical service spaces where required by Sentence (5), and
 - (c) initiating the air supply to stair shafts as may be required by Sentence (3).

Measure C (no restriction on the movement of smoke from floor to floor)

- (1) The requirements of measures to limit smoke movement in existing buildings may be met by incorporating the requirements of Sentences (2) to (7).
- (2) The public corridors leading to the required exit stairs and elevators for firefighters from every floor area on a floor above the storey on which egress directly to the outdoors occurs are provided with permanent openings to the outdoors that
 - (a) are distributed along the length of the corridor,
 - (b) have the top of the opening not more than 250 mm below the ceiling of the corridor, and
 - (c) have an aggregate open area that is not less than 10 percent of the floor area of the corridor or 1 m², whichever is greater.
- (3) A stairway serving storeys below the lowest exit level is protected as described in Sentence (3) of Measure A.
- (4) Any elevator shaft that contains an elevator for firefighters and passes through the floor above the lowest exit storey does not penetrate the floor of the storey immediately below the lowest exit storey except where there is a vestibule between the elevator door or doors and each floor area below grade as described in Sentence (3) of Measure D.
- (5) Except for exhaust from kitchens, washrooms and bathrooms in dwelling units, air moving fans are stopped during a fire emergency in an air handling system that serves more than two storeys.
- (6) Where a supply of air is required by Sentence (3), it is carried in ducts described in Sentence (13) of Measure F.
- (7) The central alarm and control facility required by Article 3.2.6.7. of Division B is provided with additional controls that are capable of
 - (a) stopping the air handling systems as required by Sentence (5), and
 - (b) initiating the air supply to stair shafts as may be required by Sentence (3).

Measures D and E Protected Vestibule Access to Stair shafts and Elevator Shafts

General

In Measures D and E, movement of smoke through stair shafts and elevator shafts is limited by the provision of vestibules that are either open to the outdoors during a fire emergency or have outdoor air injected into them. Stair shafts are further protected by opening a door to the outdoors at the bottom of the shaft. Where vestibules are protected by the injection of outdoor air, the elevator shaft is provided with a large opening to the outdoors at the bottom.

Where provisions to limit the movement of smoke in existing buildings requires the movement of smoke into floor areas to be limited, service shafts are either sealed at intervals or provided with an opening to the outdoors at the top of the shaft as described in Measure B. A typical plan of a building in which this method of smoke control is appropriate is shown in Figure 4.

Measure E is the same as Measure D, except that no measures are taken to limit movement of smoke into upper storeys in Measure E.

Where a vestibule has a vent or opening to the outdoors that is much larger than the leakage area around doors between the vestibule and other parts of the building, the air pressure in the vestibule will be approximately equal to the outdoor pressure at the same level. This is illustrated in Figure 7. In cold weather in storeys below the neutral pressure plane, air pressure in the vestibule will be substantially higher than that in the floor area. Air will tend to flow from the vestibule into the floor area. In upper storeys the air pressure in the vestibules will be less than that in the floor area, and air will flow from the floor area to the vestibule. The vent or opening at the foot of the stair shaft referred to above has the effect of increasing pressure in the shaft, so that it approaches outdoor air pressure at ground level (see Figure 21). On upper storeys the pressure in the stair shaft will be higher than that in the vestibules, and smoke that may enter the vestibules will not pass into the stair shaft.

In warm weather when outdoor air may be as warm or warmer than that inside a building, the stack effect is likely to be minimal. In these circumstances, the major problem is expansion of the hot gases on the fire floor. This will tend to force air around doors into the vestibule. The large vent opening, however, will create a situation where the greater proportion of the air entering the vestibule will pass to the outdoors and a much smaller quantity may enter the shafts. The effect of wind is variable and difficult to predict. In warm weather the effect may be to protect vestibules on one side of the building and to allow smoke to enter those on the other side.

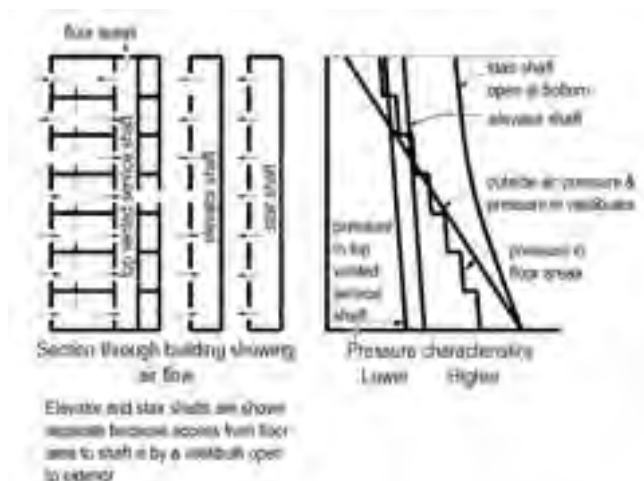


Figure 21
Pressure characteristics in a Measure D building with vented shafts

Where air is injected into vestibules, the pressure characteristics in cold weather are likely to be as shown in Figure 22. The rates of air injection should be sufficient to keep the pressures in the vestibules a little higher than the pressure in the shaft. This limits the possibility of movement of smoke into the vestibules from the floor areas. In cold weather vents at the bottom of the stair shafts and elevator shafts provide additional protection.

Service shafts that will not be used in a fire emergency are provided with vents at the top to the outdoors where Measure D (but not Measure E) requires that movement of smoke into upper floors be limited. However, some smoke may pass from top vented service shafts into the top floor or floors, because air pressures at the top of the shafts and in the floor area of the top storey are approximately equal.

Stack action and the operation of smoke control measures may provide pressures that will interfere with the normal operation of certain doors. Where a vestibule is vented to the outdoors, this may apply to any door between a vestibule and an elevator shaft that is farther above or below the mid-height of a building than the height given by Graph 8 in Appendix A of this Supplementary Standard and to any door between a vestibule and a stair shaft that is farther above grade than the height given by Graph 8. Where a vestibule is pressurized, this may apply to any door between a vestibule and a floor space that is farther above grade than the height shown in Graph 8.

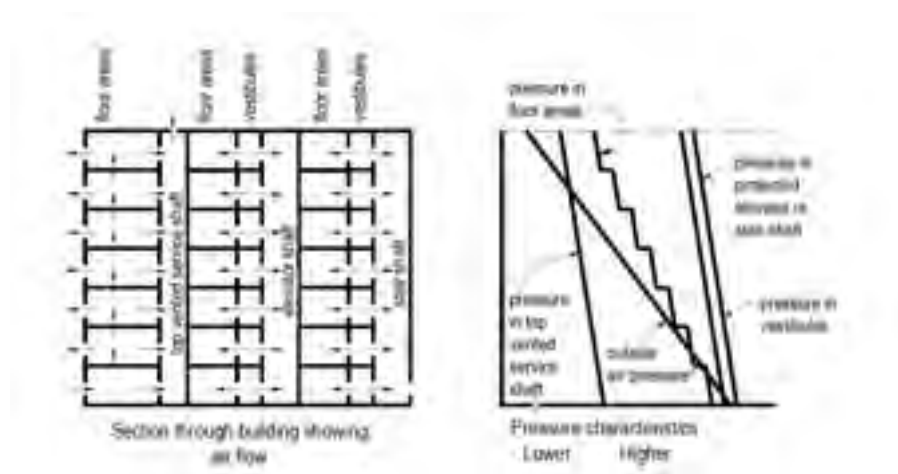


Figure 22
Pressure characteristics in a Measure D building having air injected into vestibules

As an alternative to the provision of a mechanical air supply for a vestibule to an elevator shaft, as described in Sentence (5) of Measure D, the mechanical air supply can be introduced directly into the shaft as described in Sentence (4) of Measure F provided there are no open vents to the elevator shaft as described in Sentence (9) of Measure D.

Where a mechanical air supply is required by Sentence (5) of Measure D and Sentence (4) of Measure E, it may be desirable to heat the air supply and to provide two air intakes in separate locations on the building face as discussed in the general provisions to Measures F and G.

Where Measure D is adopted, and a fire is detected by an automatic device or a manual pull station is actuated, it is intended that a fire alarm will sound on all floors simultaneously, and that the occupants of the fire floor will walk down stairs to the street floor or to a safe intermediate floor area. Occupants of other floors may remain until advised to evacuate by the person operating the central alarm and control facility.

Where Measure E is adopted, and a fire is detected by an automatic device or a manual pull station is actuated, it is intended that a fire alarm will sound on all floors simultaneously, and that occupants of all floors will walk down stairs to the street floor or to a safe intermediate floor area.

Measure D (including restriction on the movement of smoke from floor to floor)

- (1)** The requirements of measures to limit the movement of smoke in existing buildings may be met by incorporating the requirements of Sentences (2) to (17).
- (2)** Between each floor area and each stair shaft or elevator shaft that contains an elevator for firefighters, a vestibule is provided as described in Sentence (3).
- (3)** Where a vestibule is required by Sentence (2) or by other provisions of this document
- (a)** a fire separation is provided between a public corridor and the vestibule that has a fire-resistance rating of not less than 45 min,
- (b)** a fire separation is provided between a floor area, other than the corridor described in Clause (a), and the vestibule that has a fire-resistance rating not less than that required for an exit in Article 3.4.4.1. of Division B,
- (c)** a fire separation is provided between a stair or elevator enclosure and the vestibule that has a fire-resistance rating not less than that required for an exit in Article 3.4.4.1. of Division B, and
- r11.1 (d)** a door in the fire separation described in Clauses (a), (b) or (c) (except for an elevator door) is provided with a self-closing device as required by Article 3.1.8.11. of Division B, and opens in the direction of travel from the floor area to the exit stairway.
- (4)** On each floor any vestibule that has a door to an exit stair may also have a door to an elevator for firefighters, but two exit stairs may not open onto the same vestibule.
- (5)** Each vestibule described in Sentence (2) that provides access to a stair shaft or an elevator shaft
- (a)** has a vent opening to the outdoors that has an opening area not less than 0.1 m² for each door that opens onto the vestibule, but not less than 0.4 m², or
- (b)** has equipment capable of providing for a vestibule to a stair shaft or an elevator shaft a mechanical air supply not less than that obtained from Graph 3 in Appendix A of this Supplementary Standard.
- (6)** The vent to each vestibule referred to in Clause (5)(a) may be provided with a closure that is openable manually, and in a building that is more than 36 m high, it can be opened from the central control facility as provided in Sentence (17).
- (7)** A stairway serving storeys above the lowest exit level is vented to the outdoors at the bottom of the stair shaft as described in Sentence (4) of Measure A.
- (8)** A stairway serving storeys below the lowest exit level is protected as described in Sentence (3) of Measure A.
- (9)** Each elevator shaft protected by a vestibule having a mechanical air supply as described in Clause (5)(b) has a vent at or near the bottom of the shaft, opening directly to the outdoors or into a vestibule or corridor that has a similar opening to the outdoors, having an openable area not less than 0.02 m² for every door into the shaft, other than doors at street floor level.
- (10)** The vent at the bottom of an elevator shaft referred to in Sentence (9) may be provided with a closure which is openable manually and is designed to remain open during a fire emergency.
- (11)** A vertical service space other than an elevator shaft is provided with
- (a)** a tight-fitting noncombustible fire stop at the level of the floor immediately below the lowest exit storey, and at the level of certain other floors that are fire separations, provided the space between fire stops is not more than five storeys, or
- (b)** a vent to the outdoors as described in Sentence (10) of Measure F.
- (12)** Except as provided in Sentence (13), an elevator shaft other than a shaft that contains an elevator for firefighters is protected against entry of smoke by a vestibule as described in Sentence (5).
- (13)** The provisions in Sentence (12) are waived for an elevator shaft that serves floor areas below the lowest exit storey and does not penetrate the floor immediately above that storey.

(14) Except for air moving fans supplying vestibules as provided in Clause (5)(b), and except for exhaust from kitchens, washrooms and bathrooms in dwelling units, air moving fans are stopped during a fire emergency in an air handling system that serves more than two storeys.

(15) In an air handling system that is required to shut down by the provisions of Sentence (14), supply, return and exhaust ducts more than 130 cm² in cross-sectional area at the point of entry to a vertical service space are provided at that point with dampers that will close when air moving fans are stopped.

(16) Where a supply of air is required by the provisions of Sentences (5) and (8), it is carried in ducts described in Sentence (13) of Measure F.

(17) The central alarm and control facility required by Article 3.2.6.7. of Division B is provided with additional controls that are capable of

- (a) opening closures to vents to the outdoors in vestibules on all floors as required by Sentence (6), and in elevator shafts as required by Sentence (9),
- (b) stopping air handling systems and closing dampers in ducts as required by Sentences (14) and (15),
- (c) initiating the mechanical air supply to vestibules required by Clause (5)(b), and
- (d) opening closures to vents in vertical service spaces where required by Sentence (11).

Measure E (no restriction on the movement of smoke from floor to floor)

(1) The requirements of measures to limit the movement of smoke in existing buildings may be met by incorporating the requirements in Sentences (2) to (13).

(2) Between each floor area and each stair shaft or each elevator shaft that contains an elevator for firefighters, a vestibule is provided as described in Sentence (3) of Measure D.

(3) On each floor any vestibule that has a door to an exit stair shaft may also have a door to an elevator for firefighters, but two exit stairs may not open onto the same vestibule.

(4) Each vestibule described in Sentence (2) that provides access to a stair shaft or an elevator shaft

- (a) has a vent opening to the outdoors that has an openable area of not less than 0.1 m² for each door that opens onto the vestibule but not less than 0.4 m², or
- (b) has equipment capable of providing for a vestibule to a stair shaft or an elevator shaft a mechanical air supply not less than that obtained from Graph 3 in Appendix A of this Supplementary Standard.

(5) The vent to each vestibule referred to in Clause (4)(a) is provided with a closure that is openable manually, and in a building that is more than 36 m high can be opened from the central control facility as provided in Sentence (13).

(6) A stairway serving storeys above the lowest exit level is vented to the outdoors at the bottom of the stair shaft as described in Sentence (4) of Measure A.

(7) A stairway serving storeys below the lowest exit level is protected as described in Sentence (3) of Measure A.

(8) Each elevator shaft protected by a vestibule having a mechanical air supply as described in Clause (4)(b) has a vent at or near the bottom of the shaft opening directly to the outdoors, or into a vestibule or corridor that has a similar opening to the outdoors, having an openable area not less than 0.02 m² for every door into the shaft other than doors at street floor level.

(9) The vent at the bottom of an elevator shaft referred to in Sentence (8) may be provided with a closure that is openable manually and is designed to remain open during a fire emergency.

(10) Any elevator shaft that contains an elevator for firefighters and passes through the floor above the lowest exit storey does not penetrate the floor of the storey immediately below the lowest exit storey except where there is a vestibule between the elevator door or doors and each floor area below grade as described in Sentence (3) of Measure D.

(11) Except for air moving fans supplying vestibules as provided in Clause (4)(b), and except for exhaust from kitchens, washrooms and bathrooms in dwelling units, air moving fans are stopped during a fire emergency in an air handling system that serves more than two storeys.

(12) Where a supply of air is required by the provisions of Sentences (4) and (7), it is carried in ducts described in Sentence (13) of Measure F.

(13) The central alarm and control facility required by Article 3.2.6.7. of Division B is provided with additional controls that are capable of

- (a) opening closures to vents to the outdoors in vestibules on all floors as required in Sentence (5),
- (b) stopping air handling systems as required by Sentence (11), and
- (c) initiating the mechanical air supply to vestibules as required by Clause (4)(b).

Measures F and G Pressurized Stair shafts and Elevator Shafts

General

Measures F and G are suitable for use in buildings that have central cores containing elevator shafts and stair shafts and in buildings that have a spine corridor. The objective is to inject sufficient air from outdoors to provide air pressures in stair shafts and in one or more protected elevator shafts that will be at least equal to the outdoor air pressure at ground level. Protected elevator shafts may, in addition, be provided with vestibules on each floor in order to reduce the effect of the large leakage areas around elevator doors, which may otherwise require injection of excessive quantities of air in order to achieve the desired pressurization. An opening to the outdoors at the bottom of each stair shaft is required in conjunction with air injection in order to maintain the desired pressure conditions, though some doors on upper floors may be held open for a time, and to provide for dilution of smoke that may enter the stair shaft. A typical plan of a building where this method of smoke control is appropriate is shown in Figure 6.

Measure G is the same as Measure F, except that no provisions are made in Measure G to limit movement of smoke into upper floors by way of service shafts and unprotected elevator shafts.

Where smoke control measures in existing buildings requires that movement of smoke into floor areas be limited, service shafts, other than elevator shafts, are either sealed at intervals or vented to the outdoors at the top, as described in the general provisions of Measures B and C. This system is, however, likely to be more efficient than that achieved by Measure D, because injection of air into some shafts has the effect of increasing the air pressure in all floor areas. This is illustrated in Figure 23, where the pressure in the floor area of the top storey is greater than that at the top of the vented shaft.

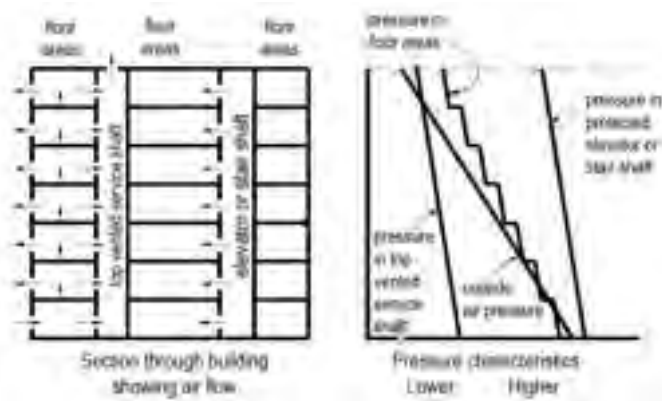


Figure 23
Pressure characteristics in a Measure F building

Treads and landings in a stair shaft present an obstacle to free flow of air. Where air is injected only at the top of a stair shaft, there is likely to be a pressure gradient between the top and the bottom of the stair shaft. This may produce pressure differences of sufficient magnitude to interfere with the opening of doors into the stair shaft in the upper part of the building. This is discussed more fully in Appendix B of this Supplementary Standard.

Stack action and the operation of smoke control measures may produce pressures across certain doors that will interfere with their normal operation. These pressures may affect any door between a floor space and a stair shaft or an elevator vestibule that is farther above grade than the height shown in Graph 8 in Appendix A of this Supplementary Standard.

In order to avoid excessive pressures across doors when outdoor temperatures are appreciably above the January design temperatures, it is recommended that the air flow into elevator shafts in buildings employing Measures F or G be reduced, but not to less than that obtained by the factor $F4 = 5.59$ according to the proportion of the air flow referred to in Sentence (4) of Measure F and Sentence (4) of Measure G. The flow reduction factors are shown in Graph 6 in Appendix A of this Supplementary Standard.

The limits are such that no modulation is required for a building whose maximum height is not more than the value in Column 2 of Table 5, provided the January design temperature is not less than the corresponding value in Column 1.

Table 5
Maximum Height of Building Not Requiring Airflow Modulation

Minimum January Design Temperature, °C	Maximum Height of Building, m
-7	94
-18	70
-29	55
-40	46
Column 1	2

Heating of the air supply referred to in Sentences (2) and (4) of Measure F or Sentences (2) and (4) of Measure G may be necessary, since to maintain the efficiency of the smoke control measures the temperature of the incoming air should be not less than the mean of indoor and outdoor temperatures at the time. To avoid damage to water systems, the temperature of air entering critical locations should be not less than 0°C. To maintain tolerable conditions for occupants, the temperature of air entering occupied spaces should be not less than 10°C.

Where a mechanical air supply is specified in Sentences (2) and (4) of Measure F or Sentences (2) and (4) of Measure G, the air should be drawn from at least two remote locations, each on a different face of the building. Each air intake should be provided with a damper that will close on a signal from a smoke detector in the duct following 30 s exposure to smoke or other products of combustion. The damper should have a manual override to reopen it when the smoke condition that caused it to close has cleared.

Where Measure F is adopted, and a fire is detected by an automatic device or a manual pull station is actuated, it is intended that a fire alarm will sound on all floors simultaneously, and that the occupants of the fire floor will walk down stairs to the street floor or to a safe intermediate floor area. Occupants of other floors may remain until advised to evacuate by the person operating the central alarm and control facility.

Where Measure G is adopted, and a fire is detected by an automatic device or a manual pull station is actuated, it is intended that a fire alarm will sound on all floors simultaneously, and that occupants of all floors will walk down stairs to the street floor.

Measure F (including restriction on the movement of smoke from floor to floor)

- (1) The requirements of measures to limit the movement of smoke in existing buildings may be met by incorporating the requirements in Sentences (2) to (14).
- (2) A stair shaft serving storeys above the lowest exit level has
 - (a) a vent or door to the outdoors at or near the lowest exit level of the stair shaft, as described in Sentence (4) of Measure A, except that the vent or door will open when the air supply referred to in Clause (b) is initiated, and
 - (b) equipment capable of providing to the shaft a mechanical air supply of not less than 4.72 m³/s plus 0.094 m³/s for every door opening into the stair shaft.
- (3) A stairway serving storeys below the lowest exit level is protected as described in Sentence (3) of Measure A.
- (4) An elevator shaft that contains an elevator for firefighters is provided with equipment capable of maintaining a flow of air to the shaft that is not less than that obtained from Graph 4 in Appendix A of this Supplementary Standard.
- (5) Where an elevator shaft referred to in Sentence (4) is provided with a vestibule on every floor, the vestibule enclosure conforms to Sentence (3) of Measure D.
- (6) Any elevator shaft that contains an elevator for firefighters and passes through the floor above the lowest exit storey does not penetrate the floor of the storey immediately below the lowest exit storey, except where each floor area below the lowest exit storey is provided with a vent to the outdoors that
 - (a) has a net area of not less than 0.2 m² for every 1 000 m² of floor area,
 - (b) will remain open during a fire emergency, and
 - (c) may be incorporated in the conventional exhaust duct system serving storeys below grade.
- (7) A vertical service space, other than an elevator shaft, is provided with
 - (a) a tight-fitting fire stop at the level of the floor immediately below the lowest exit storey and at the level of certain other floors that are fire separations provided the space between fire stops is not more than five storeys, or
 - (b) a vent to the outdoors as described in Sentence (10).
- (8) Except as provided in Sentence (9), an elevator shaft, other than a shaft that contains an elevator for firefighters, is pressurized as described in Sentence (4).
- (9) The provisions of Sentence (8) are waived for an elevator shaft that serves floor areas below the lowest exit storey and does not penetrate the floor immediately above that storey.
- (10) Where a vent to the outdoors is required by Sentence (7) or other provisions of this document, the vent
 - (a) if it is a vertical service space in a building in which other shafts are not mechanically pressurized, has an openable area that is not less than that obtained from Graph 1 in Appendix A of this Supplementary Standard, or if it is in a building in which other shafts are mechanically pressurized, has an openable area that is not less than that obtained from Graph 2 in Appendix A of this Supplementary Standard,
 - (b) if it is in a shaft serving floor areas above the lowest exit storey, is located at or near the top of the shaft where the top of the shaft is above the mid-height of the building, or at or near the foot of the shaft at or near the exit level where the top of the shaft is below the mid-height of the building,
 - (c) if it is in a shaft serving floor areas below the lowest exit storey, is located at or near the top of the shaft, and
 - (d) if it is provided with a closure, is openable both manually and on a signal from a smoke detector located at or near the top of the shaft and by a control device located at the central alarm and control facility referred to in Article 3.2.6.7. of Division B.
- (11) Except for air moving fans supplying stairs and elevators as provided in Sentences (2) to (4) and, except for exhaust from kitchens, washrooms and bathrooms in dwelling units, air moving fans in an air handling system that serves more than two storeys are capable of being stopped as provided in Sentence (14).

(12) In an air handling system that is required to shut down by the provisions of Sentence (11), supply, return and exhaust ducts more than 130 cm² in cross-sectional area at the point of entry into a vertical service space are provided with dampers that will close when air moving fans are stopped.

(13) Where a supply of air is required by the provisions of Sentences (2), (3) or (4) or by other provisions of this document, the duct system is installed in a service space conforming to Section 3.6. of Division B or is otherwise protected against the effect of fire from the point of fresh air intake to the shaft or to the storey that contains the protected floor area, vestibule or area of refuge that is required to be so protected.

(14) The central alarm and control facility required by Article 3.2.6.7. of Division B is provided with additional controls that are capable of

- (a) stopping air handling systems and closing dampers in ducts required in Sentences (11) to (13),
- (b) initiating the mechanical air supply to stair shafts and elevator shafts required in Sentences (2) to (4), and
- (c) opening closures to vents in vertical spaces where required in Sentence (7).

Measure G (no restriction on the movement of smoke from floor to floor)

(1) The requirements of measures to limit the movement of smoke in existing buildings may be met by incorporating the requirements in Sentences (2) to (9).

(2) A stair shaft serving storeys above the lowest exit level has

- (a) a vent or door to the outdoors at or near the lowest exit level of the stair shaft described in Sentence (4) of Measure A, except that the vent or door will open when the air supply referred to in Clause (b) is initiated, and
- (b) equipment capable of providing to the stair shaft a mechanical air supply of not less than 4.72 m³/s, plus 0.094 m³/s for every door opening into the stair shaft.

(3) A stairway serving storeys below the lowest exit level is protected as described in Sentence (3) of Measure A.

(4) An elevator shaft that contains an elevator for firefighters is provided with equipment capable of maintaining a flow of air to the shaft that is not less than that obtained from Graph 4 in Appendix A of this Supplementary Standard.

(5) Where an elevator shaft referred to in Sentence (4) is provided with a vestibule on every floor, the vestibule enclosure is as described in Sentence (3) of Measure D.

(6) Any elevator shaft that contains an elevator for firefighters and passes through the floor above the lowest exit storey does not penetrate the floor of the storey immediately below the lowest exit storey, except where each floor area below the lowest exit storey is provided with a vent to the outdoors that

- (a) has a net area of at least 0.2 m² for every 1 000 m² of floor area,
- (b) will remain open during a fire emergency, and
- (c) may be incorporated in the conventional exhaust duct system serving storeys below grade.

(7) Except for air moving fans supplying stair shafts and elevator shafts as provided in Sentences (2) to (4) and, except for exhaust from kitchens, washrooms and bathrooms in dwelling units, air moving fans in an air handling system that serves more than two storeys are capable of being stopped as provided in Sentence (9).

(8) Where a supply of air is required by Sentences (2) to (4), it is carried in ducts as described in Sentence (13) of Measure F.

(9) The central alarm and control facility required by Article 3.2.6.7. of Division B is provided with additional controls that are capable of

- (a) stopping air handling systems as required by Sentence (7), and
- (b) initiating the mechanical air supply to stair shafts and elevator shafts as required by Sentences (2) to (4).

Measure H Fully Pressurized Buildings

General

Measure H is appropriate for buildings having central cores that contain stair shafts and elevator shafts and windows that are not normally opened, as shown in Figure 8. The air pressure in the whole building is increased so that at grade level it is at least equal to outdoor air pressure. When a vent to the outdoors is provided on the fire floor by a window in an exterior wall, by an opening into a smoke shaft as described in Section 1 or by the building mechanical exhaust system if the building is sprinklered, the pressure in the floor area is reduced substantially, as is shown in Figure 24. Air will then flow from the shafts and other floor areas into the fire floor. The combination of building pressurization and venting of the fire floor provides that smoke will not pass into other floor areas or shafts other than the smoke shaft.

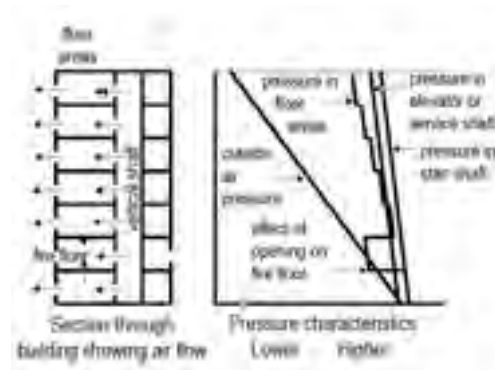


Figure 24
Pressure characteristics in a Measure H building

It is important that air be uniformly distributed throughout the building. This may be achieved by supplying the air through the conventional duct system or through vertical shafts. A minimum proportion of the air is required to be injected directly into stair shafts. This is designed to reduce the possibility, particularly in warm weather, that a substantial drop in pressure will occur in these shafts when a door to the outdoors at grade is opened, with the consequent danger that smoke will enter the shafts.

Where venting is by smoke shafts, the air supply to the floor on which fire occurs should be cut off by closing the dampers on that floor in order not to overload the smoke shaft.

The total air flow for building pressurization is modulated relative to outdoor air temperature. This is intended, in part, to limit the potential pressure drop in stair shafts and elevator shafts referred to above and, in part, to avoid excessive pressures across doors to stair shafts and elevator shafts that would interfere with their normal use.

This requirement for modulation of air flows applies generally to higher buildings. The conditions described in Sentence (3) of Measure H are such that no modulation is required where the January design temperature and the building height are as shown in Table 1.

In Toronto, for example, where the January design temperature is -18°C , no modulation of air flow would be required for a building not more than 70 m high.

This measure is not appropriate for a building where windows may normally be held open. The air flow requirements in Graph 5 in Appendix A of this Supplementary Standard are based on an assumed air leakage through the external walls that is appropriate to modern air-conditioned buildings having reasonably tight-fitting non-openable windows. If the leakage area is other than that noted above, the air flow requirement must be adjusted proportionately, as described in the notes to Graph 5.

Stack action and the operation of smoke control measures may produce pressures across certain doors that will interfere with their normal operation. This may apply to any door between a floor space and stair shaft or an elevator shaft that is farther above grade than the height shown in Graph 8 in Appendix A of this Supplementary Standard.

Where a mechanical air supply is required by Sentence (2) of Measure H, it may be desirable to heat the air supply and to provide two air intakes in separate locations on the building face, as discussed in the general provisions to Measures F and G.

Where a floor area is subdivided by walls, provision should be made for a free air passage from any part of the floor area to the vent or vents required by Sentence (6) of Measure H. Such provisions for venting need not apply to public corridors or washrooms that normally have a minimum of combustibles.

There should be no problem where vents are on outside walls, and each room or space can be vented directly to the outdoors. Where a smoke shaft is used, however, a fire may occur in a space adjacent to a stair shaft or elevator shaft which is separated by partitions from the smoke shaft vent. The solution may be to vent each space to the smoke shaft through the ceiling plenum or to provide suitable openings in the partitions. Where each room or space opens on to a corridor leading to stair shafts and elevator shafts, location of the smoke shaft vent in the corridor will be effective in limiting movement of smoke to other floors, but may also present problems to the firefighter, who may have to approach the fire through a smoke-filled corridor.

Where Measure H is adopted, and a fire is detected by an automatic device or a manual pull station is actuated, it is intended that a fire alarm will sound on all floors simultaneously, and that the occupants of the fire floor will walk down stairs to the street floor or to a safe intermediate floor area. Occupants of other floors may remain until advised to evacuate by the person operating the central alarm and control facility.

Measure H

- (1) The requirements of measures to limit the movement of smoke in existing buildings may be met by incorporating the requirements in Sentences (2) to (9).
- (2) The building air handling system is designed and installed so that
 - (a) supply fans are capable of maintaining an air flow into the building not less than that obtained from Graph 5 in Appendix A of this Supplementary Standard when the outdoor air temperature is equal to the January design temperature on a 2.5 percent basis, and
 - (b) a portion of the air flow referred to in Clause (a) is directed into each stair shaft in a quantity equal to 0.094 m³/s for every weatherstripped door into the stair shaft and 0.142 m³/s for every non-weatherstripped door into the stair shaft.
- (3) Exit stairs shall discharge to the outdoors through a vestibule described in Sentence (3) of Measure D and be provided with a mechanical air supply of not less than 0.094 m³/s per weatherstripped door and 0.189 m³/s per non-weatherstripped door in the vestibule, except that the vestibule may be a corridor, lobby or other space.
- (4) When smoke control measures are initiated by the controls referred to in Sentence (9)
 - (a) all main return and exhaust fans are stopped,
 - (b) supply fans provide the air flow into the stair shafts described in Clause (2)(b), and
 - (c) supply fans maintain an air flow into the building controlled in relation to outdoor air temperature, so that the total air flow into the building is substantially equal to the proportion of the air flow referred to in Clause (2)(a) shown in Graph 6 in Appendix A of this Supplementary Standard, but not less than the air flow obtained when the factor F6 equals 0.0025.
- (5) All openings in external walls and roofs, including vents to vertical service spaces other than those referred to in Sentence (7), have closures that will close as provided in Sentence (9).
- (6) All return and exhaust ducts more than 130 cm² in cross-sectional area at the point of entry to a vertical service space are provided with dampers that will close on the floor on which fire occurs as required by Sentence (9), other than those covered by Sentence (7).

- (7) In order to achieve a reduction in air pressure on the floor on which fire occurs relative to that on other floors, means of venting each floor space to the outdoors are provided as described in Section 1.
- (8) Where a supply of air is required by Sentence (2), it is carried in ducts as described in Sentence (13) of Measure F.
- (9) The central alarm and control facility required by Article 3.2.6.7. of Division B is provided with additional controls capable of
- stopping main return and exhaust fans and maintaining the air flow in the supply systems as provided in Sentence (2),
 - closing the closures and dampers required in Sentences (5) and (6), and
 - opening closures to the vent openings on the fire floor as provided in Sentence (7).

Measures I and J Partially Pressurized Buildings

General

Measures I and J are very similar to Measure H, except that they may be applied to buildings where windows may be open during normal use. They are thus particularly suitable for controlling smoke movement in residential buildings. Plans of typical buildings where Measures I and J are appropriate are shown in Figures 9 and 10. The central core, which includes exit stair shafts, elevator shafts and public corridors, is separated from the remainder of the floor areas. It is important that the leakage area of walls around the core be less than that of the exterior walls of the building.

Measure J is the same as Measure I, except that no provision is made in Measure J to limit smoke movement into upper floors by way of vertical shafts and ducts that are outside the core.

Air is injected into the core so that the air pressure in the core at the ground floor is equal to exterior air pressure at the same level. Provision of a vent to the outdoors in the fire suite will cause air to flow from adjacent parts of the building into the fire suite. This is the only method, apart from Measure B, that enables smoke to be confined to the fire suite.

Where movement of smoke from floor to floor outside the central core is to be limited as in Measure I (but not J), all vertical service shafts, other than elevator shafts, penetrating floor areas must be sealed at intervals or vented to the outdoors at the top, as discussed in the general requirements of Measure D.

The air flow requirements in Graph 5 in Appendix A of this Supplementary Standard are based on the air leakage characteristics of typical corridor walls and doors. If the leakage areas exceed those given in the notes to Graph 5, the air flow should be increased in direct proportion.

Stack action and the operation of smoke control measures may produce pressures across certain doors that will interfere with their normal operation. This may apply to any door between a suite and a corridor that swings into the corridor and is farther above grade than the height shown in Graph 8 in Appendix A of this Supplementary Standard.

Within a suite that is subdivided by partitions, the space that includes the vent to the outdoors described in Sentence (4) of Measure I should be in the same space as the door to the public corridor or linked to it by a leakage area of not less than 0.05 m².

Where a mechanical air supply is required by Sentence (2) of Measure I and Sentence (2) of Measure J, it may be desirable to heat the air supply and to provide two air intakes in separate locations on the building face as discussed in the general provisions to Measures F and G.

Where Measure I is adopted and a fire is detected by an automatic device or a manual pull station is actuated, it is intended that a fire alarm will sound on all floors simultaneously, and that the occupants of the fire floor will walk down stairs to the street floor or to a safe intermediate floor area. Occupants of other floors may remain until advised to evacuate by the person operating the central alarm and control facility.

Where Measure J is adopted and a fire is detected by an automatic device or a manual pull station is actuated, it is intended that a fire alarm will sound on all floors simultaneously, and that occupants of all floors will walk down stairs to the street floor or to a safe intermediate floor area.

Measure I (including restriction on the movement of smoke from floor to floor)

- (1) The requirements of measures to limit the movement of smoke in existing buildings may be met by incorporating the requirements in Sentences (2) to (10).
- (2) The building air handling system is designed and installed so that supply fans are capable of maintaining an air flow into the space that includes all required exit stair shafts, all shafts containing elevators for firefighters and public corridors, not less than that obtained from Graph 5 in Appendix A of this Supplementary Standard, when the outdoor air temperature is equal to the January design temperature on a 2.5 percent basis.
- (3) Any vent at the top of a vertical service shaft within the central core and all other openings penetrating the space that includes the stair shafts, elevator shafts and public corridors are provided at the point of penetration with closures that will close in the event of a fire, as provided in Sentence (10).
- (4) Means of venting each fire compartment to the outdoors are provided by
 - (a) an opening in an exterior wall, such as an openable window or panel, having an openable area of not less than 0.4 m²,
 - (b) an opening into a smoke shaft, as described in Section 1, operated by a smoke detector, or
 - (c) an exhaust system, such as a kitchen or washroom exhaust, that has an air flow to the outdoors of not less than 0.189 m³/s per fire compartment served, provided the exhaust system is designed to function as a smoke shaft and meets the relevant requirements of Section 1.
- (5) Where a closure is provided in an opening referred to in Clauses (4)(a) or (b) it will open
 - (a) by operation of a fusible link, or
 - (b) on a signal from a smoke detector in the room or suite.
- (6) A vertical service space that is outside the pressurized space referred to in Sentence (2) is provided with
 - (a) a tight-fitting noncombustible seal or fire stop
 - (i) at the level of the floor immediately below the storey in which egress directly to the outdoors occurs, and
 - (ii) at the level of certain other floors that are fire separations, provided the space between fire stops is not more than five storeys, or
 - (b) a vent to the outdoors as described in Sentence (10) of Measure F.
- (7) Except as otherwise provided in Sentences (2) and (4), and except for exhaust from kitchens, washrooms and bathrooms in dwelling units, air moving fans are stopped during a fire emergency in an air handling system that serves more than two storeys.
- (8) In an air handling system that is required to shut down by Sentence (7), supply, return and exhaust ducts more than 0.013 m² in cross-sectional area at the point of entry to a vertical service space are provided with dampers that close when the air moving fans are stopped.
- (9) Where a supply of air is required by Sentence (4), it is carried in ducts as described in Sentence (13) of Measure F.
- (10) The central alarm and control facility required by Article 3.2.6.7. of Division B is provided with additional controls that are capable of
 - (a) stopping return and exhaust fans, closing dampers in ducts and maintaining the air flow in the supply system to the space that includes stair shafts, elevator shafts and corridors as provided in Sentences (2) and (7),
 - (b) causing dampers and closures in the enclosing walls of the space that includes stair shafts, elevator shafts and corridors to close as required by Sentence (3),
 - (c) opening closures to vents in vertical service spaces where required by Sentence (6),
 - (d) opening closures in vents referred to in Sentence (4), individually or in groups limited to one floor at a time, and
 - (e) initiating the air flow in the exhaust system from any floor, where required by Clause (4)(c).

Measure J (no restriction on the movement of smoke from floor to floor)

- (1) The requirements of measures to limit the movement of smoke in existing buildings may be met by incorporating the requirements in Sentences (2) to (6).
- (2) The building air handling system is designed and installed so that supply fans are capable of maintaining an air flow into the space that includes all required exit stair shafts, all shafts containing elevators for firefighters and public corridors, not less than that obtained from Graph 5 in Appendix A of this Supplementary Standard, when the outdoor air temperature is equal to the January design temperature on a 2.5 percent basis.
- (3) Any vent at the top of a vertical service shaft within the central core, and all other openings penetrating the space that includes the stair shafts, elevator shafts and public corridors, are provided at the point of penetration with closures that will close in the event of fire, as provided in Sentence (4).
- (4) Except as otherwise provided in Sentence (2), and except for exhaust fans from kitchens, washrooms and bathrooms in dwelling units, air moving fans are stopped during a fire emergency in an air handling system that serves more than two storeys.
- (5) Where a supply of air is required by Sentence (2), it is carried in ducts as described in Sentence (13) in Measure F.
- (6) The central alarm and control facility required by Article 3.2.6.7. of Division B is provided with additional controls that are capable of
 - (a) stopping return and exhaust fans and maintaining the air flow in the supply system to the space that includes stair shafts, elevator shafts and corridors as provided in Sentence (2), and
 - (b) causing dampers and closures in the enclosing walls of the space that includes stair shafts, elevator shafts and corridors to close as required by Sentence (3).

Measure K Vertically Divided Buildings

General

In Measure K a degree of protection for occupants is achieved by providing either a spatial separation or a fire separation between two parts of the building as shown in Figures 11 and 12. Under these conditions, except as subsequently noted, air pressures on either side of the division will be symmetrical and smoke should not pass from one side to the other. Smoke from fire in one part of the building may be expected to pass into the stair shafts, elevator shafts and floor areas on the fire side, while the equivalent spaces on the other side will remain smoke free. Vestibules and bridges are provided as means of access to refuge areas for occupants of floor areas in the part of the building that is exposed to fire and smoke.

Vestibules or bridges are either vented to the outdoors or pressurized mechanically in order to prevent their acting as paths for the transmission of smoke. In vented vestibules below the neutral pressure plane of the building, air will normally flow from the vestibules to the floor areas and no smoke should enter the vestibules. In vestibules above the neutral pressure plane, air will flow from the floor area to the vestibule and thence to the outdoors.

If a window breaks in the fire area, the pressure in the fire area will be the same as that in the vestibule and no smoke transfer should occur. Where vestibules are mechanically pressurized, the air flow will always be from the vestibule to the floor areas on either side, thus limiting the possibility of smoke entering the vestibule.

Provision of an opening to the outdoors at the foot of a stair shaft will increase the air pressure in the shaft in winter and thus reduce the probability of entry of smoke from a floor on which a fire occurs.

Where a dividing wall is used to separate the two parts of a building (Figure 12), breakage of a window in a fire compartment below the neutral pressure plane can be undesirable. The pressure in the fire compartment will increase to a level approximately the same as exterior pressure, and this may cause substantial smoke flow through the dividing wall from the fire side to the other side of the building. This consideration does not apply to a spatial separation as shown in Figure 11. Provisions have been included to allow windows below the mid-height of a building on the side away from a

fire to be opened manually in order to bring the pressure in that space to the exterior pressure and to eliminate the pressure difference across the dividing wall.

While the most efficient solution to the problem of moving occupants to a place of safety is to have bridges or connecting vestibules at each floor level, the requirements in Measure K are that such bridges or vestibules should be at intervals of not more than five storeys, and in the case of residential buildings more than 75 m high, the bridges or vestibules should be on each storey. The approaches to the bridges or vestibules are by stairs and corridors whose width is controlled by Sentences (6) and (7) of Measure K. These provisions combine to enable all occupants to reach a place of safety in about three minutes.

Stack action and the operation of smoke control measures may produce pressures across certain doors that will interfere with their normal operation. This may apply where a building has vestibules vented to the outdoors

- (a) at any door that swings into a vestibule from a floor space farther below the mid-height of the building than the distance shown in Graph 8 in Appendix A of this Supplementary Standard,
- (b) at any door that swings out of a vestibule from a floor space that is farther above the mid-height of the building than the distance shown in Graph 8 in Appendix A of this Supplementary Standard,
- (c) at any door between a floor space and an elevator shaft that is farther above or below the mid-height of the building than the distance shown in Graph 8 in Appendix A of this Supplementary Standard,
- (d) at any door between a floor space and a stair shaft that is farther above grade than the height shown in Graph 8 in Appendix A of this Supplementary Standard.

In a building that has vestibules that are pressurized, pressures that may interfere with the normal operation of doors may occur with any door between a vestibule and a floor space where the rate of air injection exceeds $0.165 \text{ m}^3/\text{s}$ for each weatherstripped door, or $0.33 \text{ m}^3/\text{s}$ for each door that is not weatherstripped, and any door between a floor space and an elevator shaft that is farther above or below the mid-height of the building than the height shown in Graph 8 in Appendix A of this Supplementary Standard.

Where a mechanical air supply is required by Sentence (11) of Measure K, it may be desirable to heat the air supply and to provide two air intakes in separate locations on the building face as discussed in the general provisions to Measures F and G.

Where Measure K is adopted and a fire is detected by an automatic device or a manual pull station is actuated in a smoke control region of the building, it is intended that a fire alarm will sound on all floors in that smoke control region, and that the occupants on all floors will move through the dividing vestibules or bridges to the other smoke control region.

Measure K

- (1) The requirements of measures to limit the movement of smoke in existing buildings may be met by incorporating the requirements of Sentences (2) to (17).
- (2) The building is designed as
 - (a) a structure divided into two smoke control regions by a continuous vertical fire separation that has a fire-resistance rating not less than that required for a floor in Subsection 3.2.2. of Division B, or
 - (b) two or more smoke control regions separated by spatial separations that conform to the provisions of Subsection 3.2.3. of Division B.
- (3) Bridges or vestibules are provided at intervals of not more than five storeys to permit movement of occupants from one smoke control region to the other, except that in the case of residential buildings more than 75 m high, the bridges or vestibules are located on each storey.
- (4) In each smoke control region referred to in Sentence (2), there is not less than one exit stair shaft and one elevator in a shaft that meets the requirements of Article 3.2.6.5. of Division B and that is not common to both smoke control regions.

- (5) The floor area on either side of a bridge or vestibule is of sufficient size to accommodate its own normal population, plus the occupants of the one to five storeys of the adjacent smoke control region who may have to enter the floor area during a fire emergency, assuming 0.5 m² per ambulatory person and 1.5 m² per non-ambulatory person.
- (6) The width of each bridge or vestibule and each connecting corridor and door on the same storey is sufficient to provide not less than 3.67 mm of width for each person who may have to use these passages to reach the floor area referred to in Sentence (5) from the adjacent smoke control region.
- (7) The width of each stair or ramp that provides access to a floor having a bridge or vestibule from intervening floors is sufficient to provide not less than 5.5 mm of width for each person who may have to use the stair to reach the bridge or vestibule referred to in Sentence (6).
- (8) Between each bridge or vestibule and public corridor is a fire separation that has a 45 min fire-resistance rating.
- (9) Between each bridge or vestibule and a floor area other than the public corridor referred to in Sentence (8), is a fire separation that has a fire-resistance rating as required for exits in Subsection 3.4.4. of Division B
- (10) Each door opening into a bridge or vestibule conforms to Articles 3.4.6.9. and 3.4.6.10. of Division B and is suitably identified as an access to an area of refuge.
- (11) Each bridge or vestibule is provided with
- a vent opening to the outdoors that has an open area not less than 1 m² and that may be provided with a closure that is openable manually, or
 - a mechanical air supply not less than that obtained from Graph 7 in Appendix A of this Supplementary Standard that will be initiated as provided in Sentence (17).
- (12) Where the building is divided into two smoke control regions by a fire separation as described in Clause (2)(a), each floor area below the mid-height of each smoke control region is provided with a vent opening to the outdoors that has an open area of not less than 1.5 m² and that is normally closed but can be opened manually.
- (13) Each stair shaft is vented to the outdoors as described in Sentence (4) of Measure A.
- (14) Except as provided in Sentence (11), and except for exhaust from kitchens, washrooms and bathrooms in dwelling units, air moving fans are stopped during a fire emergency in an air handling system that serves more than two storeys.
- (15) Floor areas below the lowest exit storey are divided by a fire separation that has a fire-resistance rating not less than that required in Clause (2)(a) and is in a location corresponding to the fire or spatial separations required for upper storeys. Doorways protected by pressurized vestibules are provided in the separations as described in Clause (11)(b).
- (16) Where a supply of air is required by Sentences (11) and (15), it is carried in ducts as described in Sentence (13) of Measure F.
- (17) The central alarm and control facility required by Article 3.2.6.7. of Division B is provided with additional controls that are capable of
- closing doors in fire separations required by Sentences (8), (9) and (15) between floor areas and vestibules,
 - initiating the mechanical air supply to the vestibules where required by Clause (11)(b) and Sentence (15), and
 - stopping air handling systems where required by Sentence (14).

Measure L Areas of Refuge (smoke free areas)

General

Measure L is intended to provide refuge areas which occupants may enter during a fire. It may be used for buildings that have many openings between floors so that it is impracticable to confine smoke to one floor level.

This measure is basically the same as described in Measure D, except that larger quantities of air must be injected into each area of refuge than into a comparable vestibule in order to maintain tolerable conditions for the occupants. A typical floor plan is shown in Figure 13. The area of refuge may include normally occupied space in the building, and because fire may occur in one of these spaces, provision is made for alternative groups of areas of refuge.

Except in the case of Group C buildings more than 75 m high, areas of refuge may be provided on every fifth floor if the access routes are made wide enough to allow all occupants to reach the area of refuge within three minutes (see Figure 14). Stair shafts and elevators for firefighters must be protected on intermediate floors by vestibules or by pressurization of the shafts.

Stack action and the operation of smoke control measures may produce pressures across certain doors that will interfere with their normal operation. This may apply to any door between an area of refuge and a floor space that is farther above grade than the height shown in Graph 8 in Appendix A of this Supplementary Standard.

Between every area of refuge and the floor space the building should have a vent fitted with a self-closing damper that will permit air to move from the area of refuge to the floor space but not vice-versa. It should have an openable area not less than 6 cm² for every 0.005 m³/s of air injected into the area of refuge in excess of that specified in Measure D for a pressurized vestibule.

Where Measure L is adopted and a fire is detected by an automatic device or a manual pull station is actuated, it is intended that an alarm will sound on all floors simultaneously, and that occupants of all floors will move to areas of refuge distributed throughout the building and await instructions over the voice communication system.

Where a mechanical air supply is required by Sentence (9) of Measure L, it may be desirable to heat the air supply and to provide two air intakes in separate locations on the building face, as discussed in the general provisions to Measures F and G.

Measure L

- (1) The requirements of measures to limit the movement of smoke in existing buildings (except measures to limit the movement from storeys below the lowest exit level into upper storeys) may be met by incorporating the requirements of Sentences (2) to (20).
- (2) Two independent groups of areas of refuge are distributed through the building so that there is an area of refuge in each group at least at every fifth storey, and each group is linked by a common exit stair to the exterior at grade.
- (3) On any floor area any area of refuge that has a door to an exit stair may also have a door to an elevator for firefighters, but two exit stairs may not open on to the same area of refuge if no other vertical shaft is common to the two independent systems described in Sentence (2).
- (4) Each group of areas of refuge referred to in Sentence (2) can accommodate all the occupants of above grade storeys at the rate of 0.5 m² of floor area per ambulatory person or 1.5 m² per non-ambulatory person.
- (5) The width of corridors and doors leading to an area of refuge on the same storey is sufficient to provide 3.67 mm of width for each person who may have to use these passages to reach the area of refuge.
- (6) The width of stairs or ramps leading to an area of refuge from intervening floors is sufficient to provide 5.5 mm of width for each person who may have to use the stairs or ramps to reach the area of refuge.

- (7) Between each area of refuge and a public corridor is a fire separation that has a 45 min fire-resistance rating.
- (8) Between each area of refuge and a floor area other than the public corridor referred to in Sentence (7), is a fire separation that has a fire-resistance rating as required for exits in Subsection 3.4.4. of Division B
- (9) Each door opening into an area of refuge conforms to the provisions for doors in Article 3.4.6.10. of Division B and is suitably identified as an access to an area of refuge.
- (10) Each area of refuge is provided with a mechanical air supply not less than that required for a vestibule providing access to a stair shaft or an elevator shaft in Clause (5)(b) of Measure D, and obtained from Graph 3 in Appendix A of this Supplementary Standard, or not less than $0.002 \text{ m}^3/\text{s}$ for each occupant of the area of refuge during a fire emergency, whichever is greater.
- (11) Any door in an exit stair shaft or in a shaft that contains an elevator for firefighters that does not open directly into an area of refuge is provided with a pressurized vestibule as described in Sentence (5) of Measure D, except where the stair shaft or elevator shaft is pressurized as described in Sentences (2) and (4) of Measure F.
- (12) Except as provided in Sentence (11), an elevator shaft that contains an elevator for firefighters is provided with a pressurized vestibule as described in Sentences (2), (3) and (5) of Measure D or is pressurized as described in Sentence (4) of Measure F.
- (13) Any elevator shaft that contains an elevator for firefighters or opens into an area of refuge and passes through the floor above the lowest exit storey does not penetrate the floor of the storey immediately below the lowest exit storey, except where there is a vestibule between the elevator door or doors and each floor area below grade as described in Sentence (3) of Measure D.
- (14) A stair shaft serving storeys above the lowest exit level is vented to the outdoors at or near the bottom of the stair shaft as described in Sentence (4) of Measure A.
- (15) A stairway serving storeys below the lowest exit level is protected as described in Sentence (3) of Measure A.
- (16) Each elevator shaft protected by a vestibule or area of refuge having a mechanical air supply as described in Sentences (9) and (10) has a vent at or near the bottom of the shaft opening directly to the outdoors or into a vestibule or corridor that has a similar opening to the outdoors having an openable area not less than 0.023 m^2 for every door into the shaft, other than doors at street floor level.
- (17) The vent at the bottom of an elevator shaft referred to in Sentence (16) may be provided with a closure which is openable manually and is designed to remain open during a fire emergency.
- (18) Except for air moving fans serving areas of refuge and vestibules as provided in Sentences (10) to (12), and except for exhaust from kitchens, washrooms and bathrooms in dwelling units, air moving fans are stopped during a fire emergency in an air handling system that serves more than two storeys.
- (19) Where a supply of air is required by Sentences (10), (11), (12) and (15), it is carried in ducts as described in Sentence (14) of Measure F.
- (20) The central alarm and control facility required by Article 3.2.6.7. of Division B is provided with additional controls that are capable of
- closing doors in fire separations required by Sentences (7) and (8) between floor areas and areas of refuge or vestibules,
 - stopping air handling systems as required by Sentence (18),
 - opening closures in vents to the outdoors in elevator shafts that may be required by Sentence (12), and
 - initiating the mechanical air supply to the areas of refuge, vestibules and shafts as may be required by Sentences (10), (11), (12) and (15).

Measure M Residential Buildings with Balconies

General

In residential buildings the greater part of the requirements for control of smoke movement are waived where each suite has direct access to a balcony. The protective features are limited to stopping air handling systems, providing an opening to the outdoors at the foot of stair shafts serving upper floors and protection of stair shafts in storeys below grade. A typical arrangement is shown in Figure 16.

Where Measure M is adopted and a fire is detected by an automatic device or a manual pull station is actuated, it is intended that occupants on the fire floor will evacuate if possible, and that occupants of other floors may remain in their suites to await instructions.

Measure M

- (1) The requirements specific to existing unsprinklered residential buildings may be met by incorporating the requirements of Sentences (2) to (7).
- (2) A stair shaft serving storeys above the lowest exit level has a vent or door to the outdoors at or near the bottom of the stair shaft, as described in Sentence (4) of Measure A.
- (3) A stairway serving storeys below the lowest exit level is protected as described in Sentence (3) of Measure A.
- (4) Any elevator shaft that passes through the floor above the lowest exit storey does not penetrate the floor of the storey immediately below the lowest exit storey, except where there is a vestibule between the elevator door or doors and each floor area below grade as described in Sentence (3) of Measure D.
- (5) Except for exhaust from kitchens, washrooms and bathrooms in dwelling units, air moving fans are stopped during a fire emergency in an air handling system that serves more than two storeys.
- (6) Where a supply of air is required by Sentence (3), it is carried in ducts as described in Sentence (13) of Measure F.
- (7) The central alarm and control facility required by Article 3.2.6.7. of Division B is provided with additional controls that are capable of
 - (a) stopping air handling systems as required by requirements specific to existing unsprinklered residential buildings, and
 - (b) initiating the mechanical air supply to stair shafts as may be required by Clause (3)(c).

Measure N Connected Buildings

General

r11.1 The measures described here are intended to prevent movement of smoke from one building to another. They are of particular significance where two buildings of unequal height are joined together. The techniques suggested are the provision of a large opening to the outdoors in a connecting vestibule so that smoke entering through leakage areas around doors will be vented to the outdoors, or pressurization to maintain a higher pressure in the vestibule than in adjacent spaces as illustrated in Figures 17 to 18A.

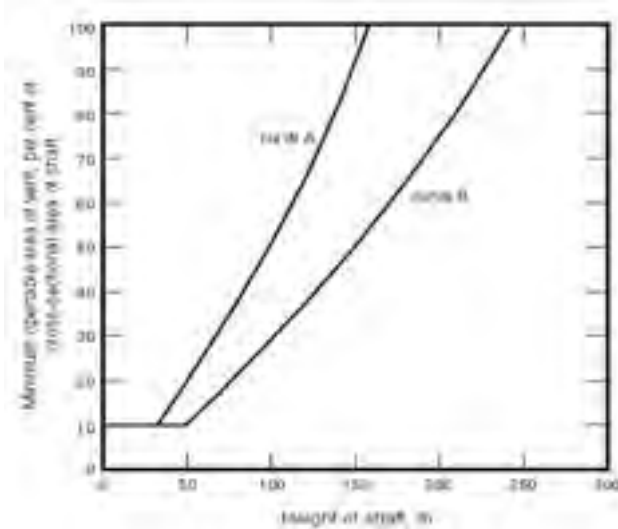
The requirements for protection of openings are described in terms appropriate to a doorway. Any other openings should be avoided if possible. Where they occur, they should be protected by the provision of an air lock that gives the same standard of protection as the vestibule described in Sentence (3).

Measure N

- (1) The requirement of Sentence 3.2.6.3. of Division B that limits movement of smoke from one building to another may be met by incorporating in the link between the buildings the requirements in Sentences (2) and (3).
- (2) Between one building and the other is a firewall as described in Subsection 3.1.10. of Division B.
- (3) Any opening in the firewall is protected against passage of smoke by a vestibule described in Sentence (3) of Measure D and has
 - (a) a vent to the outdoors that has a net area of $10(0.023d + 0.00045a)$ m², where d is the number of doors having a perimeter not more than 6 m that open into the vestibule, or if the perimeter of doors exceeds 6 m, the value of d is increased in direct proportion to the increase in the perimeter, and a is the area in square metres of enclosing walls, floors and ceilings whose outer face is in contact with the outside air, except that where the outer face of a wall is in contact with the ground or fill, it is assumed that there is no leakage through that portion, and the value of a is assumed to be zero, or
 - (b) equipment capable of maintaining a supply of air into the vestibule sufficient to ensure that the air pressure in the vestibule when the doors are closed is higher by at least 12 Pa than that in adjacent floor areas when the outdoor temperature is equal to the January design temperature on a 2.5 percent basis.

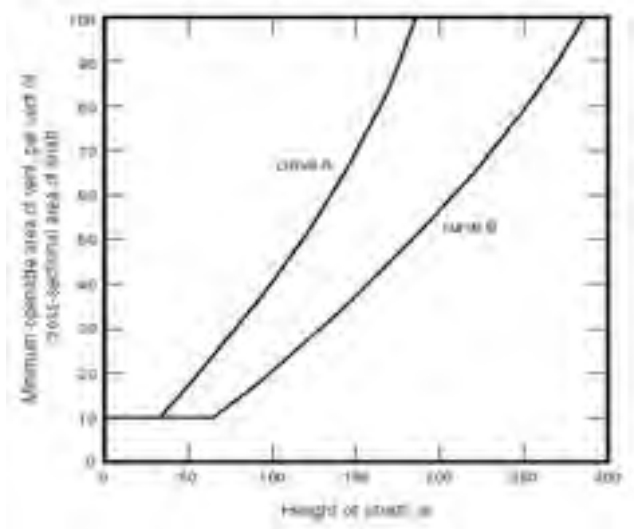
Appendix A to SB-4

Graphs for Applying Smoke Control Measures



Graph 1

Vent to a vertical service space where no other shaft in the building is pressurized

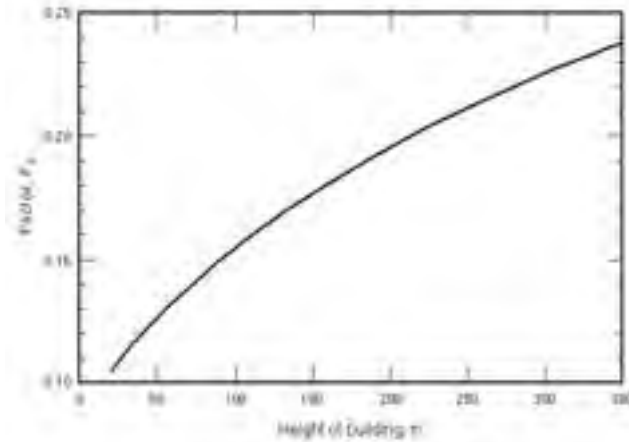


Graph 2

Vent to a vertical service space where other shafts in the building are pressurized

Notes to Graphs 1 and 2:

- (1) Curve A applies to a vertical service space that is enclosed by unplastered unit masonry or by plaster and steel stud construction with all openings in the shaft sealed to the degree required by Articles 3.1.9.2. to 3.1.9.4. of Division B.
- (2) Curve B applies to a vertical service space that is enclosed by monolithic concrete or by plastered unit masonry with all openings in the shaft sealed tightly to minimize air leakage.
- (3) A shaft having a vent that is 100 percent of the cross-sectional area of the shaft is acceptable for buildings up to 1.5 times the height shown by the appropriate curve in Graphs 1 and 2.
- (4) The total leakage area, based on measurements arrived at in typical high buildings, is assumed to be 0.025 m² for every 10 m² of shaft wall area in the case of Curve A and 0.015 m² for every 10 m² of shaft wall area in the case of Curve B.



Graph 3
Factor for mechanical air supply to a vestibule

Notes to Graph 3:

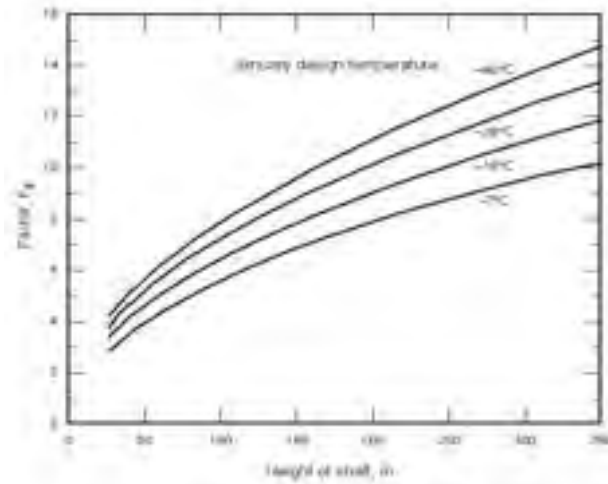
- (1) The air supply to each vestibule in cubic metres per second equals

$$F_3d + 0.071e + 0.094s$$

where

- F_3 is a factor obtained from Graph 3,
 d = the number of doors having a perimeter not more than 6 m between each vestibule and a floor area,
 e = the number of doors having a perimeter not more than 6 m between each vestibule and an elevator shaft, and
 s = the number of doors having a perimeter not more than 6 m between each vestibule and a stair shaft. The quantity " $F_3d + 0.071e + 0.094s$ " represents the total leakage from the vestibule.

- (2) If the perimeter of a door exceeds 6 m, the value of d , e or s must be increased in direct proportion to the increase in the perimeter.
 (3) A double leaf door is counted as two doors in this formula.
 (4) A door provided with tight-fitting weatherstripping is counted as one half of a door.
 (5) The height of the building is the number of metres between the roof and the floor level of the lowest basement floor.



Graph 4
Factor for air supply to an elevator shaft

Notes to Graph 4:

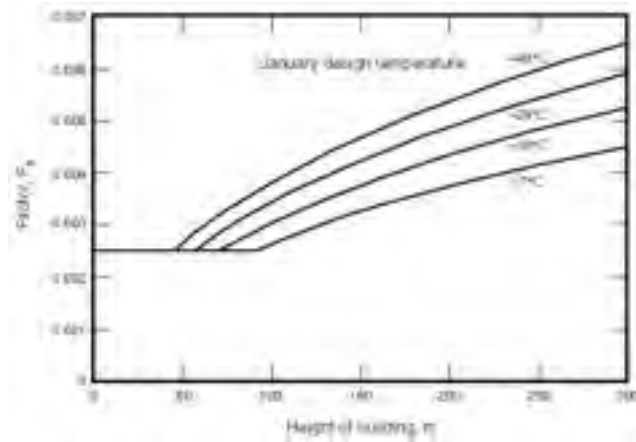
- (1) The air supply to each elevator shaft in cubic metres per second equals

$$F_4(0.023d_4 + 0.0014a_4)$$

where

- F_4 is the factor obtained from Graph 4
 d_4 = total number of doors having a perimeter not more than 6 m that open into the elevator shaft, and
 a_4 = area of enclosing walls of the shaft in square metres. The expression "0.023 d_4 + 0.0014 a_4 " represents the total leakage area in the walls of the shaft.

- (2) If the perimeter of a door exceeds 6 m, the value of d_4 must be increased in direct proportion to the increase in the perimeter.
 (3) A double leaf door is counted as two doors in this formula.
 (4) A door provided with tight-fitting weatherstripping is counted as one half of a door.
 (5) If the enclosing walls of the shaft are of monolithic concrete or of unit masonry plastered on one side, the value of a_4 may be halved.
 (6) If an elevator shaft is provided with vestibules on each floor, the enclosing walls considered in this formula may be taken as including those of the vestibules if it leads to an economy in air supply requirements. In this case d_4 above refers to doors between the vestibules and the floor areas and doors between the elevator shaft and the vestibules do not enter into the calculation.



Graph 5
Factor for air supply for building pressurization

Notes to Graph 5:

- (1) If Measure H is used, the air supply delivered to the whole building in cubic metres per second equals

$$F_5 \times a_5$$

where

F_5 is a factor obtained from Graph 5, and
 a_5 = area of all exterior wall surfaces of the building in square metres measured between ground level and underside of the roof. (Where the outer face of a wall is in direct contact with the ground or fill, it is assumed that there is no leakage through that portion, and the value of a_5 is assumed to be zero.)

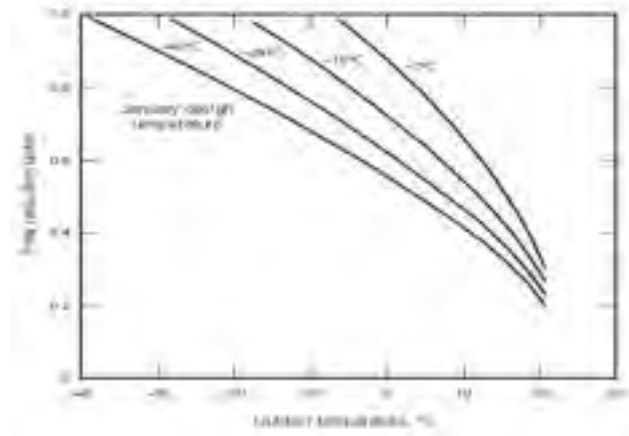
- (2) Graph 5 is based on an air leakage rate of 0.003 m³/s per square metre of exterior wall at a pressure difference of 75 kPa, based on the measured leakage rate in high buildings having fixed windows and curtain wall panels.
 (3) This is equivalent to a leakage area in exterior walls of 0.045 m² per 100 m² of wall area. If the leakage area in a building differs significantly from this, the air supply should be adjusted in direct proportion.
 (4) The height of building is measured between the underside of the roof and the floor level of the lowest basement floor.
 (5) If Measure I or J is used, the air supply delivered to the space that includes stair shafts, elevator shafts and corridors in cubic metres per second equals

$$F_5(a_6 + 51d_6)$$

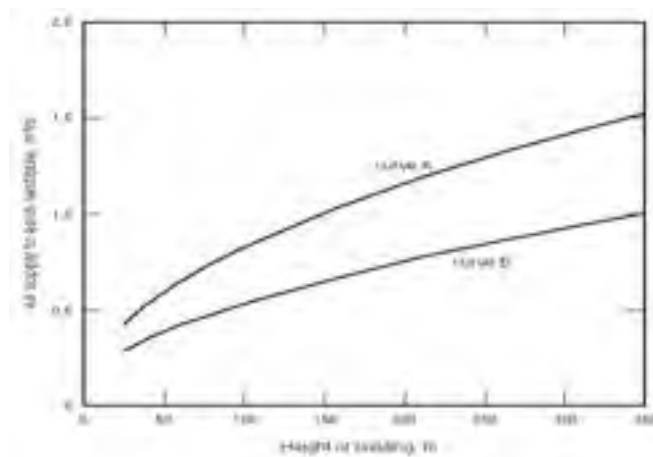
where

F_5 is a factor obtained from Graph 5 that is not less than 0.0025,
 a_6 = area in square metres of the walls enclosing the space that includes stair shafts, elevator shafts and associated corridors on all floors, and
 d_6 = total number of doors having a perimeter not more than 6 m in the wall area described in a_6 .

- (6) If the enclosing walls described above are of monolithic concrete or of unit masonry plastered on one side, the value of a_6 may be halved.
 (7) If the perimeter of a door exceeds 6 m, the value of d_6 must be increased in direct proportion to the increase in the perimeter.
 (8) A double leaf door is counted as two doors in this formula.
 (9) A door provided with tight-fitting weatherstripping is counted as a one half of a door.



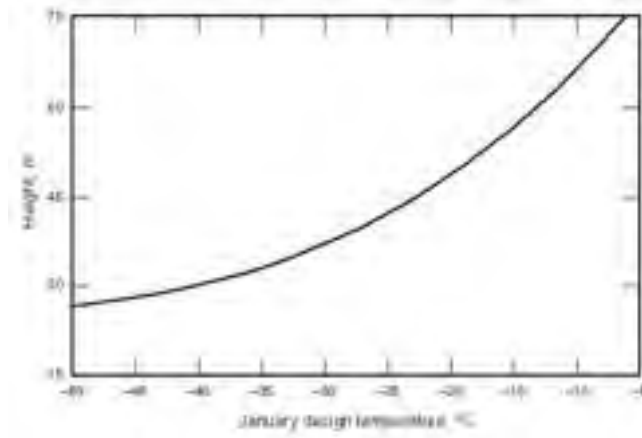
Graph 6
Flow reduction factors



Graph 7
Air supply to vestibule in a vertically divided building

Notes to Graph 7:

- (1) Curve A shows the air supply to each vestibule in cubic metres per second for a vestibule that has four doors (or two double doors), each door having a perimeter of not more than 6 m, between the vestibule and the floor areas on either side of the building.
- (2) Curve B shows the air supply to each vestibule in cubic metres per second for a vestibule that has two single doors, each door having a perimeter of not more than 6 m, between the vestibule and the floor areas on either side of the building.
- (3) If the perimeter of a door exceeds 6 m, the air supply must be increased in direct proportion to the increase in the perimeter.
- (4) If the doors are provided with tight-fitting weatherstripping, the air supply may be halved.
- (5) The height of building is the distance between the roof and the floor level of the lowest basement floor.



Graph 8

Height of the shaft relative to grade, or the neutral pressure plane at which pressure across a door may exceed 95 Pa

Appendix B to SB-4

Assumptions Used in Developing Fire Safety Measures

The objectives of the measures for fire safety in high buildings are

- (a) to provide for the safety of the occupants of a building, either by maintaining the tenability of the occupied floor spaces during the period of a fire emergency or by making it possible for occupants to move to a place of safety,
- (b) to maintain tenable conditions in which occupants may remain in exit stairs leading from floor spaces to the outdoors, and
- (c) to maintain tenable conditions in elevators that can be used to transport firefighters and their equipment from the street floor to the floor immediately below the fire floor.

It is assumed that the firefighters will use one of the protected stair shafts referred to in (b) to walk up to the fire floor from the floor below.

The first of these objectives may be met by the evacuation of all occupants to the outdoors in from seven to ten minutes, by the movement of occupants to safe areas within the building in from three to five minutes (as in Measures C, E, G, J, K, L and M) or by maintaining the tenability of all floor areas except those on the fire floor and the floor above the fire floor (as in Measures A, B, D, F, H and I).

The requirements in the Building Code covering widths of exits and travel distances to exits make it possible for occupants of a floor on which a fire occurs to leave that floor within one or two minutes provided their escape route is not cut off by the fire.

The objectives of the measures are to maintain certain spaces substantially smoke free for a significant period of time during a fire emergency, and hence some criterion of tenability is called for. The criterion for long term tenability is that a space shall not include more than one percent by volume of the contaminated atmosphere from the fire region. The criterion of tenability is based on visibility and carbon monoxide concentration.

Mechanisms of Smoke Movement in Buildings

Movement of a smoky atmosphere within a building is not significantly different from that of a normal atmosphere at the same temperature. The principal constituent of both atmospheres is nitrogen. The fact that the concentrations of other component gases will differ and that a smoky atmosphere will contain particulate matter will not influence its overall density to an extent that will significantly affect its movement. The mechanisms to be discussed do, therefore, relate to the movement of a smoky atmosphere as well as a normal atmosphere.

Air Circulating Systems

An obvious mechanism for the dispersal of smoke within a building is the recirculating air handling system. Assuming that the system has been competently designed, the approximate extent of the recirculation under any particular circumstances is known, and hence the build-up in any area of contamination can be predicted.

Effect of Wind

Exterior winds create pressure differentials within buildings, which lead to internal air movement, principally horizontal. Some upward movement also results, however, from the non-uniformity of the wind profile up the side of a building. In addition, if one side of the building is facing the wind, only that face will be subjected to a positive pressure, the remainder being subjected to negative pressure.

Expansion

Another smoke movement mechanism, which is of considerable significance during the early stages of any fire that is not well vented to the outdoors, is the expansion process associated with heating. The leakage characteristics of virtually any building are such that the rate of temperature rise occurring in the fire region cannot create pressure differentials greater than about 250 Pa (gauge). Instead, the volume of the atmosphere increases linearly with absolute temperature. During the development of a fire in a compartment, absolute temperature may be expected to triple, and the volume of gas will increase by approximately the same factor. At least two-thirds of the original atmosphere in the fire region will, therefore, be displaced by this mechanism.

Generation of gases as a result of combustion has also been considered. The volume created by this phenomenon cannot, however, exceed 20 percent of the original volume, and is not likely to be significant compared to expansion due to temperature rise.

Stack Effect

Whenever a temperature differential exists between the interior and exterior of an enclosure, a phenomenon known as stack or chimney effect prevails. Figure B-1 illustrates the case where the interior temperature is higher than the exterior, and there is an inflow of cold air at low levels and a corresponding outflow at high levels.

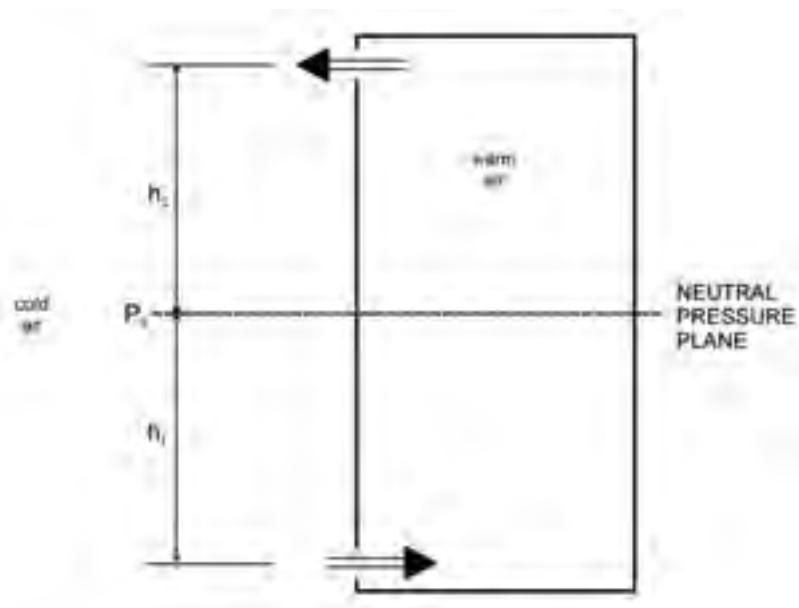


Figure B-1
Stack action

This effect can result from building heating and from temperature differentials created by the fire itself and is particularly important in Canadian buildings because of the cold winter conditions. The pressure differentials generated by stack effect can be calculated by considering the densities of the internal and external atmospheres.

Figure B-1 represents a simplified model in which air flows in at a low level and out at a high level, while there is an intermediate level where there is no pressure differential between interior and exterior. This level is referred to as "the neutral pressure plane". Taking the pressure at the neutral plane as P_0 , the pressures at the lower or upper openings can be derived, for they are associated with the weights of the columns of gas above them.

The resulting expression for the pressure difference across the lower opening is

$$\delta p = h_1 g \rho_0 \theta / T_0$$

where

- δp = pressure difference,
- h_1 is defined in Figure B-1,
- T_0 = absolute outdoor temperature,
- θ = difference between indoor and outdoor temperature,
- ρ_0 = density of indoor air, and
- g = acceleration due to gravity.

Substituting $H = (h_1 + h_2)$ will give the total of the pressure head (the sum of the pressure differentials across the upper and lower openings) generated by stack effect.

Importance of Mechanisms Responsible for Smoke Movement

Expansion due to heating of the atmosphere in a fire compartment is largely a transient phenomenon occurring at the development stage of a fire. Two-thirds of the atmosphere of the fire region is likely to be displaced and, if the region were not vented to the exterior, there could be a significant movement of smoke laden atmosphere to other parts of the building. Dispersed evenly throughout the building, and taking into account leakage to outdoors, this displaced atmosphere could render untenable a space equal to about 50 times that of the fire region.

Pressures Due to Stack Effect

In discussing the steady state conditions responsible for smoke movement, total pressure heads generated may be compared. These pressure heads are tabulated in Table B-1 together with the flow rates that they will create beneath a typical door having a free space of 900 mm x 12.5 m beneath it. In Columns 2 and 3, the total head given by stack action resulting from a fire in a single storey is also given by stack action associated with building heating during cold weather in a building three to four storeys high.

Table B-1
Magnitudes of Pressures Developed by Thermal and Wind Effects Magnitudes

Pressure Head, Pa	Height of Heated Compartment, m		Wind Speed, km/h	Flow Beneath Door with 900 x 12.5 mm Gap, m ³ /s
	800°C above ambient (i.e., on fire)	50°C above ambient		
25	2.9	10.3	23	0.045
50	5.8	20.6	33	0.064
125	14.5	51.6	52	0.1
250	29.1	103.3	73	0.142
500	58.2	206.4	104	0.201
Column 1	2	3	4	5

Assuming that a building is compartmented, fire other than one in a shaft should be confined to a single storey. The total pressure head generated by the fire is thus not likely to exceed about 25 Pa. As buildings are generally heated in their entirety, stack effect associated with building heating can give a total head significantly more than 25 Pa if the building is more than about four storeys high. Thus combating stack action associated with building heating in high buildings is likely to pose more of a problem than combating stack action directly associated with a fire. In high buildings emphasis should be placed on the building heating rather than the fire stack action problem.

Effect of Wind

Column 4 of Table B-1 indicates that pressures resulting from winds can be substantial. As mentioned earlier, the greater part of the resulting airflow is horizontal. This does not create as great a hazard as vertical movement via the shafts in a building. An upward flow does exist, however, and its effect is virtually identical to that of stack action associated with building heating. Combating the latter will, therefore, take account of the more hazardous influence of winds.

Contribution of Air Handling Systems

The effect of recirculating air handling systems is not shown in Table B-1, but it is substantial and hence it must be considered when smoke control techniques are being devised for buildings including such systems.

Significance of Smoke Movement Mechanisms

Given the considerations just discussed, the most significant smoke movement mechanisms to be combated are

- (1) operating recirculating air-handling systems,
- (2) the expansion process occurring during the initial stages of a fire, and
- (3) stack action associated with building heating.

Techniques for Avoiding Widespread Smoke Contamination

Techniques for avoiding widespread smoke contamination in a high building can be divided into the following categories:

(1) Avoidance of any significant fire. The first approach in this category is to exclude or limit combustible materials from a building. Calculations of air movement due to stack effect have indicated that the destruction by fire of very small quantities of combustible material can produce enough smoke to produce untenable conditions in upper floors and vertical shafts of a high building. Limits on the use of smoke producing materials are thus unlikely to be adequate as a sole means of smoke control. Automatic extinguishment of a fire can also be considered as an approach to limiting smoke generation provided the quantity of combustibles destroyed is held within strict limits.

(2) Compartmentation. Where a floor area is divided into a number of fire compartments, the potential size of a fire will be limited to the contents of one compartment. In addition there will be, in some circumstances, dilution of smoke moving from the fire compartment to other floors.

Where the fire occurs below the neutral plane, in cold weather the path of smoke travel may be along a corridor to stair shafts and elevator shafts. In this case the smoke in the corridor will be diluted by clean air coming from other compartments. In an ideal situation (uniform compartments, no expansion and no wind), dilution of the smoke laden air will be in proportion to the number of compartments. Breaking of a window in the fire compartment will, however, increase the pressure in that space and will reduce the effect of dilution.

Where smoke travel occurs through a vertical shaft from a compartment involved in fire to higher compartments, the level of contamination will not be related to the number of units on one floor, but will likely be restricted to units on other floors that are adjacent to the vertical shaft.

The result of compartmentation is, therefore, likely to be beneficial, but does not eliminate the need for smoke control measures.

(3) Location of shafts outside the building envelope. The vertical transfer of smoke to the upper storeys of a building from fire on a lower storey occurs largely by the vertical shafts in the building rather than through the floors, about 95 percent or more in the case of a typical 20-storey building. Separation of the shafts from the building would thus largely solve the problem. This approach constitutes one of the suggested methods of smoke control.

(4) Dilution. Dilution by a factor of about 100 of the smoke gases issuing from a fire region will provide a tenable atmosphere. This feature could form the basis of a smoke control method, air being injected into the building at

appropriate rates at those locations where smoke is being discharged from the fire region into adjacent parts of the building. When cold weather conditions are considered, however, dilution alone is not likely to be very practical. In general, it would be better if the injection of air were directed to modifying the pressure pattern within a building in order to limit any undesirable movement of smoke.

Dilution as a means of reducing smoke contamination should, nevertheless, be considered as an important secondary factor governing a designer's choice of smoke control method. Its importance is in dispersing contamination that might develop as a result of delay in implementing smoke control measures, or of other occurrences such as the opening of a number of doors that might interfere with the operation of a smoke control measure. The amount of air required to dilute a contaminated atmosphere to a tenable level can be calculated approximately. If no mixing were to occur between the contaminated and the clean air, and the contaminated air were to move out ahead of the clean air, one volume of the clean air injected into a compartment would produce a smoke free atmosphere. In practice, however, some mixing does occur.

If perfect mixing is assumed in a compartment that has reached a level of contamination equivalent to that of the fire compartment, and no more smoke is entering, the amount of clean air needed to create the one percent tenable atmosphere discussed would be five times the volume of the compartment. If, however, we are considering a compartment isolated from the fire compartment by a fire separation and self-closing doors, it is more reasonable to assume that the level of contamination likely to occur is about one-fifth of that in the fire compartment. In these circumstances, injection of three volumes of clean air would be sufficient to produce a tenable atmosphere. If clean air is injected at the rate of one volume every two minutes, the atmosphere in the compartment would be satisfactory in about six minutes.

These figures are based on the expression

$$c = c_0 e^{at}$$

where

- c_0 = initial concentration of contaminant,
- c = final concentration of contaminant,
- a = rate of diluent air flow in number of air changes per minute,
- t = time in minutes between occurrence of initial and final concentration, and
- e = 2.718.

Based on this calculation, assuming perfect mixing of the contaminated air and the diluent air,

- c/c_0 = 0.368 after injection of one volume of clean air,
- 0.135 after injection of two volumes of clean air,
- 0.050 after injection of three volumes of clean air,
- 0.018 after injection of four volumes of clean air, and
- 0.007 after injection of five volumes of clean air.

(5) Adjustment of pressure differential distribution. This category of smoke control technique involves modification of the pressure pattern within the building. The pressure distribution within a building is illustrated by the pressure characteristic diagrams in Figure B-2. The graphs represent, in an exaggerated manner, the pressure differences between floor areas, shafts and exterior at the same height above ground. The pressure difference shown amounts to little more than 500 Pa, whereas the total pressures involved are about 100 kPa. The graphs do relate pressure to heights, and thus cannot be used to determine pressure difference between one floor and another at a different height. Given any set of characteristics as in Figure B-2, the important feature is that, during cold weather, air flow from one region to another at the same level will be towards the region that is at a lower pressure. In the typical building whose characteristics are illustrated, smoke generated at a low level will flow into shafts, up through the shafts and out into floor spaces at the higher levels.

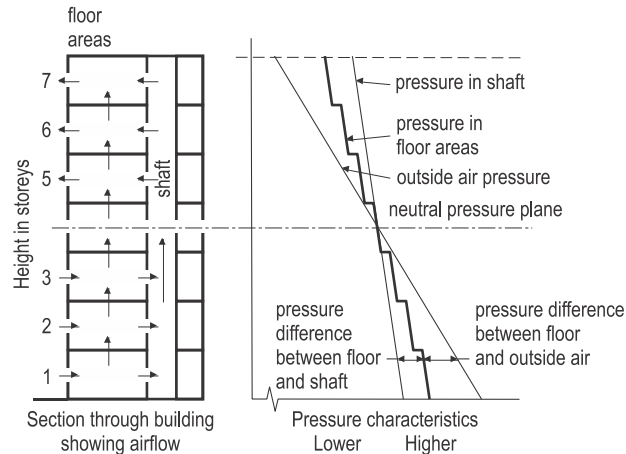


Figure B-2
Pressure characteristics of a typical building

Shafts provide the major paths for the spread of smoke within a building, so one should note the effect of venting on their characteristics. Figure B-3 shows the characteristics of a simple heated shaft under three different venting arrangements, the second and third (Figures B-3(b) and B-3(c)) having obvious advantages in controlling smoke movement in buildings.

In Figure B-3(b) the shaft is vented to the outdoors at the top, and smoke entering the shaft at any level would not leave it until it reached the top opening. If a corresponding condition were established within a building, the shaft would, therefore, not constitute a path for the transmission of smoke from low level to high level floor spaces. In Figure B-3(c) the shaft is vented to the outdoors at the bottom, fresh air enters the shaft at the lowest level and leaves it through any leakage area at any other level in the shaft. Such a condition for a shaft in a building would be most valuable, for as well as being eliminated as a path for smoke dispersal, the shaft also has a clear atmosphere. These conditions, however, may not be sustained long as the atmosphere in the shaft will cool as a result of the influx of cold air, and the characteristic will approach that of the exterior atmosphere. Injection of warm air into the shaft is necessary to maintain these conditions over a prolonged period.

Where a smoke control method is concerned with changing the pressure pattern within a building, many of the measures involved are based on the preceding concept of changing the pressure characteristic of a shaft. Since shafts are the principal paths by which smoke disperses throughout a building, the aim will be either to decrease or to increase shaft pressures substantially. Both measures will eliminate vertical smoke transfer by the shaft between floor spaces. Top venting the shaft as in Figure B-3(b) or use of mechanical exhaust to approach these pressure characteristics will, however, also result in the entry of smoke into the shaft, while pressurizing the shaft, such as by mechanical injection, will maintain a tenable atmosphere in the shaft.

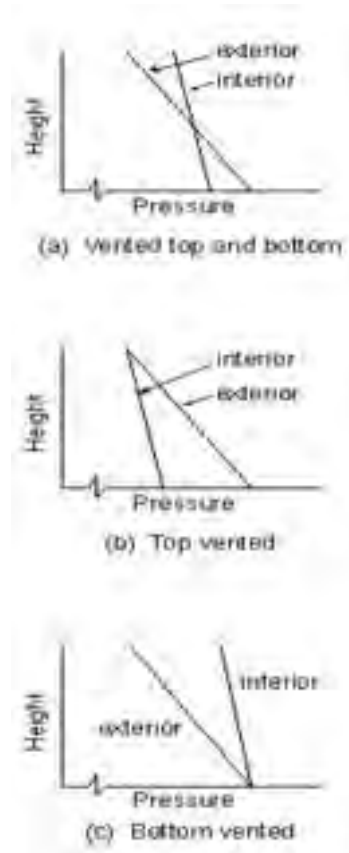


Figure B-3
Shaft characteristics

(6) **Smoke shafts.** A smoke shaft differs from a vented service shaft in that an opening is provided into the shaft from the fire floor in addition to the opening to the outside at the top of the shaft.

Until windows in outer walls are broken, a smoke shaft alone can be an effective means of limiting movement of smoke into other floors and shafts. In cold weather, the shaft air is warmer than the outdoor air and the shaft will begin to function as a vent as soon as the dampers are opened. During warm weather there will be some delay, as the smoke shaft cannot function as a vent until hot air has entered the shaft as a result of initial expansion in the fire region. The pressure conditions that prevail during cold weather are shown in Figure B-4. The air pressure on the fire floor, having an opening into the smoke shaft, is below that in adjacent unvented shafts and adjacent floor areas. Air flow will be from the adjacent floor areas and shafts into the fire floor, and from the fire floor into the smoke shaft. If, however, a window is broken on a fire floor at a lower level, the air pressure in the fire region will be increased to approximately that of outdoor air at the same level. Smoke may then flow into stair shafts and elevator shafts and adjacent floor areas. During warm weather, breaking of a window will allow venting of smoke to the outdoors for a fire on any floor, except when wind is blowing towards the open window. In this event, breaking of the window will cause the action of the smoke shaft to be overwhelmed. The smoke shaft, therefore, is not fully effective as a sole method of smoke control in a floor area with windows, but can be used in conjunction with building pressurization as part of a smoke control method. The size of a smoke shaft is related to conditions to be established in the event of a fire at a lower level of the building and is dependent on the leakage characteristics of the building. Any increase in the air leakage through the walls of the building and the shafts requires a corresponding increase in the size of the smoke shaft. In Figure B-4 the idealized smoke shaft pressure characteristic is indicated by a dotted line and assumes no pressure losses inside the shaft. As the smoke shaft is open to the outside at the top, pressure at the top level of the smoke shaft is equal to that of outside air.

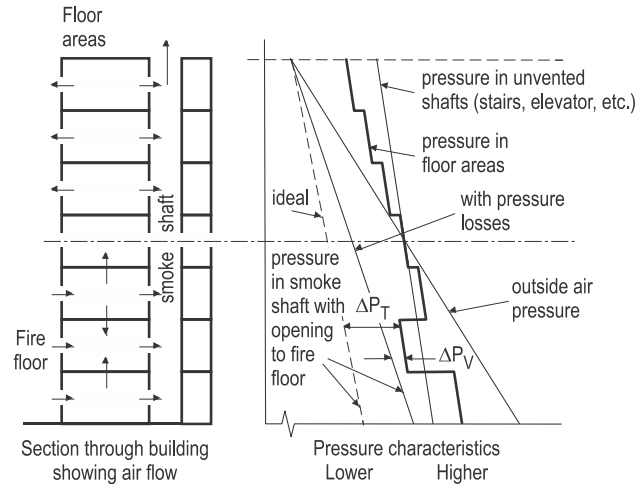


Figure B-4
Pressure differences produced by a smoke shaft

Assuming an air temperature inside a smoke shaft equal to that of the building, as may occur in the case of a small fire, the slope of the smoke shaft pressure characteristic is the same as those of the vented shafts. In Figure B-4 the total pressure (DPT) acting across the vent opening at the bottom is represented by the horizontal distance between floor space and smoke shaft pressure characteristics. The value of DPT is about one half of the total pressure head generated by stack action over the height of the building. The values of DPT are plotted against building height for various outside temperatures in Figure B-5. The movement of air through the smoke shaft causes a decrease in building pressures, which results in the shifting of the floor space pressure characteristic to the left in the pressure diagram. This results in a lower effective value of DPT. The values of DPT have been adjusted to take this factor into account. So far it has been assumed that no pressure losses occur inside the smoke shaft. Friction, momentum and dynamic pressure losses can, however, occur inside the smoke shaft, as a result of air flow through the open vent of the fire floor, as well as through leakage openings in the walls of the smoke shaft. The smoke shaft pressure characteristic including pressure losses is also shown in Figure B-4 as a solid line. The actual pressure difference across the open smoke vent DP_v is less than DPT, the difference between the two values representing the pressure losses inside the smoke shaft. The flow requirement to achieve the desired venting action depends on the pressure differences across the fire floor enclosure caused by stack action, and on the air tightness of the various interior and exterior separations of the building. The flow rates shown in Figure B-6 were calculated initially for a 20-storey building having a floor plan measuring 36 m by 36 m, with assumed leakage through walls and floors consistent with the results of air movement measurement obtained in several multi-storey buildings. Extrapolation was made for buildings of various heights, floor areas and outside temperatures using the following relationships:

- (1) QV is proportional to FA ,
- (2) QV is proportional to $H^{1/2}$, and
- (3) QV is proportional to

$$\frac{(T_i - T_o)^{1/2}}{T_o}$$

where

- | | |
|-------|--|
| QV | is the required flow rate through the floor vent of the smoke shaft, FA is the flow area of a typical floor, |
| H | is the height of building, |
| T_i | is the indoor absolute temperature, and |
| T_o | is the outdoor absolute temperature. |

A number of other considerations may have to be taken into account in applying measures for control of smoke movement.

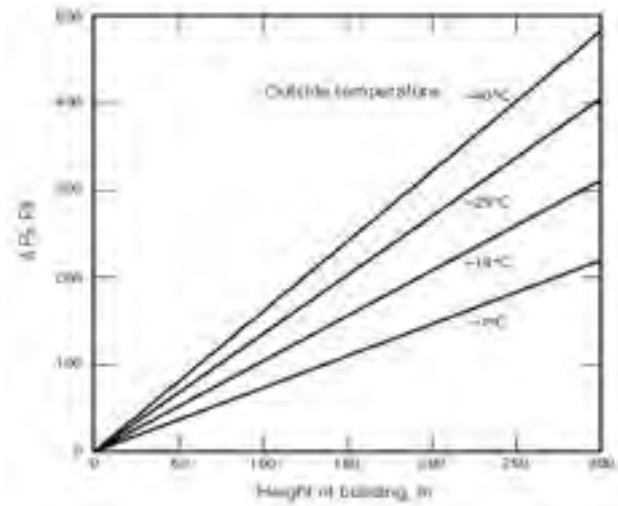


Figure B-5
Available total pressure versus building height

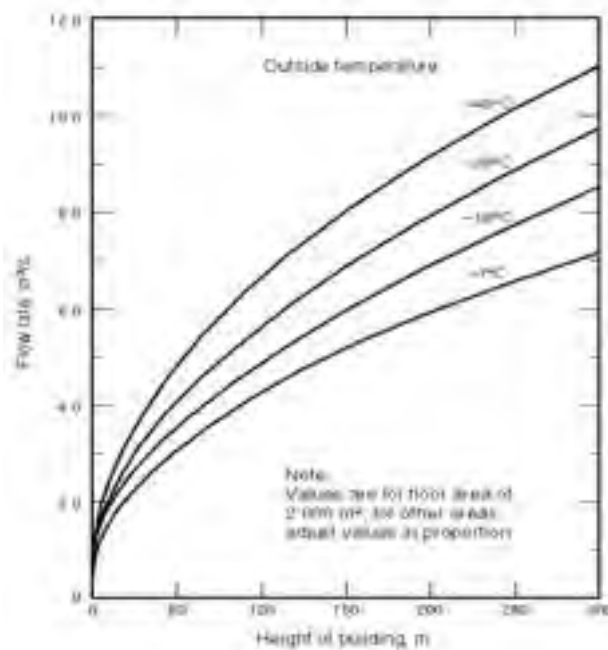


Figure B-6
Required venting capacity of smoke shaft

(7) **Make-up air.** In the case of smoke control systems that depend on a supply of make-up air from outside the building for pressurization or dilution, the air intakes should be located so that there is little possibility of smoke or other products of combustion being drawn into the air handling system. The source of the smoke could be a fire in the building. The smoke could reach the air intakes as a result of siting the intakes close to the discharge from a smoke shaft or as a result of wind patterns directing smoke that has been vented out through the building envelope towards the intakes. Other sources of smoke are vents from fuel fired equipment, including furnaces and emergency electricity generators, and fire in an adjacent part of a building separated from the building under consideration by fire separations and vestibules, as would occur in the use of Measure K. Air intakes located near ground level should be sited so that exhausts from emergency and other vehicles are not likely to be drawn into the air handling system.

Breaking of Windows on the Fire Floor

Where the room in which a fire occurs has windows, they will probably be broken at a fairly early stage. This will result in a change of pressure in the fire region to substantially that of outdoor air pressure at that level. In Figure B-2, for a fire at a low level in the building during cold weather, breaking of windows will greatly increase the pressure in the region involved. As a result more smoke may be expected to pass into adjacent floors and vertical shafts. This has been taken into consideration in the measures described in Section 3.

Pressures Across Doors

Problems may occur where air pressures across typical hinged doors and sliding elevator doors interfere with their normal use. This may occur when the pressure across a door exceeds 100 Pa. Pressure differences of this magnitude may occur in cold weather where a door communicates with a space that is substantially at outdoor air pressure. This commonly occurs at the entrance doors to high buildings during normal use. The problem is resolved in this case by use of revolving doors or by special hinges which permit the door to rotate about the centre until a sufficient opening is formed to relieve the pressure on the door. It may also occur when windows on a fire floor are broken or where vestibules vented to the outdoors are employed, as in Measure D in Section 3. Situations where such problems may arise are indicated in the explanatory notes to each smoke control measure.

Explosions in Smoke Shafts

An explosion may occur in a smoke shaft during a fire. The maximum over-pressure predicted on the basis of a British report would probably not exceed about 16.5°C. This has been considered, and because it is a somewhat remote possibility, no special precautions are recommended.

Pressure Drop in Stairs

Recent studies have shown that air supply requirements for stairwells with an open door at grade level can cause a substantial pressure drop due to friction. If the air is injected only at the top of particular designs of stairwell in a high building, a non-uniform pressure distribution over the height of the stair shaft may occur. This may produce an undesirably high pressure differential across stairwell doors at high levels. This problem may be avoided by injection of the air at several levels rather than only at the top.

Warm Weather Conditions

The smoke control techniques have been developed to function under cold weather conditions; their performance under warm weather conditions has, however, been carefully considered. Undesirable pressures may be created across certain doors, and certain spaces such as a stair shaft may be contaminated when the door to the outdoors is open. Where air injection is used, modulation of the supply with exterior temperature can be a solution to the problem, although such action reduces the effect of the air supply in diluting transient smoke contamination. Where no interior-exterior temperature differential exists, building heating does not cause stack action and its influence as a smoke movement mechanism disappears. Assuming air handling systems to be shut down, expansion becomes a major factor in spreading smoke throughout a building. Under these conditions the influence of a simple vent opening in an external wall can be readily assessed. Flow through all openings in the walls around the fire region will be roughly in proportion to their area. If the area of the vent to the exterior is ten times the area of the openings communicating to the remainder of the building, only about ten percent of the displaced smoke laden atmosphere will pass into other parts of the building.

During cold weather, expansion may be responsible for a slight overall increase in pressure of about 25 Pa in the fire region for about 20 minutes.

Appendix C to SB-4

Check of a Smoke Control System

The efficiency of a smoke control system may be checked by measuring pressure differences and the directions of air flow around doors and through separating walls of compartments. A pressure meter can be used to measure pressure differences on either side of a door or partition. Where this is impracticable, a punk stick held near a crack will give an indication of the direction of air flow. Measurements of air flow may be taken on the intake side of supply fans or in supply ducts to determine whether the specified air flow is being provided.

In general, air flow should be from the spaces which may be occupied during a fire emergency (e.g., stair shafts) toward the space in which the fire is assumed to have occurred. For each method of smoke control, measurements may be taken at certain critical locations to check the overall efficiency of the system.

In buildings designed by Measure B, C, D or E, where protection is obtained by venting corridors or vestibules to the outdoors, inspection of the building to determine whether the requirements have been met should be sufficient. In buildings incorporating Measure B, C, D, E, F or G, service shafts may be vented to the outdoors at the top. In this case a check may be made of the wall between the shaft and the uppermost occupied floor areas, to ensure that the direction of flow is from each floor area into the shaft, when the vent to the outside is open and the outdoor air temperature is significantly less than that indoors. In a building incorporating Measure D or E, where mechanically pressurized vestibules are used, and in a building incorporating Measure L, a check may be made to ensure that the pressure in each vestibule or area of refuge is greater than that in the adjacent floor areas at each floor level.

In a building incorporating Measure F or G, the efficiency of a protected elevator shaft can be checked by using a meter to measure pressure differences between the shaft and the outdoors at grade, before and after actuation of the air injection system. The difference between the two readings gives the mechanical pressurization of the shaft, which should be at least equal to one half of the calculated pressure difference caused by stack action over the height of a building for the January design temperature and the design flow rate specified in Sentence (4) of Measure F or Sentence (4) of Measure G. Where the air flow is modulated, the mechanical pressurization should vary between 50 Pa when the outdoor temperature is equal to that indoors, and one half of the pressure difference noted above when the outdoor temperature is equal to the January design temperature. Flow rates into the elevator shaft may be checked against that specified in Sentence (4) of Measure F and Sentence (4) of Measure G. Stair shafts may be checked with the air injection system operating and the door or vent to the outdoors open. Flow rate through the shaft should be equal to that required by Sentence (2) of Measure F and Sentence (2) of Measure G. Top vented service shafts may be checked as described for a building incorporating Measure B, C, D or E.

In a building incorporating Measure H, the efficiency of the system may be checked by measuring pressure differences between floor areas at grade and outdoors before and after actuation of the air injection system. The magnitude of the mechanical pressurization is obtained as described above in the case of elevator shafts in a building incorporating Measure F or G and should be equal to half the pressure difference caused by stack action over the height of the building for the January design temperature and the design flow rate specified in Sentence (2) of Measure H. The effect of modulating air flow for different temperature conditions is also as described for elevator shafts. Flow rates into the building may be checked against those required in Sentence (2) of Measure H. A check may be made on each floor individually, with the air injection system operating and the damper to the smoke shaft or panel to the outdoors open. Under these circumstances, air flow should be from the stair shafts, elevator shafts and service shafts into the floor area that has a damper or panel open.

In a building incorporating Measure I or J, pressure differences should be measured between the central core at grade and a suite that has a number of windows open to the outdoors before and after actuation of the air injection system. The magnitude of mechanical pressurization is obtained as described above in the case of elevator shafts in a building incorporating Measure F or G and should be equal to one half of the pressure difference caused by stack action over the height of the building for the January design temperature and design flow rate specified in Sentence (2) of Measure I. The

effect of modulating air flow for different temperature conditions is also as described for elevator shafts. Flow rates into the central core may be checked against those required in Sentence (2) of Measure I.

In a building incorporating Measure K, inspection should indicate whether or not there is a continuous separation between two parts of the building, extending from the roof through storeys below grade. Where pressurized vestibules are used, a check may be made to ensure that the direction of air flow is from each vestibule into adjacent floor areas at each level. The check should also be made on a low level floor with the floor space vents referred to in Sentence (12) of Measure K, or other windows in the two halves of the building open on that floor. This represents the condition when the fire has broken windows in one half of the building and the compensating vent in the other half of the building has been opened manually.

In a building incorporating Measure L, the method of checking is the same as in a building incorporating Measure D or E, except that flow rates into areas of refuge should be measured to ensure that they meet the requirements of Sentence (9) of Measure L.

Doors to stair shafts, elevator shafts and vestibules that are indicated in the notes relating to each measure as being in locations subject to pressure differences that may interfere with normal opening should be checked when the outdoor temperature is near the January design temperature, with the air injection system operating and a number of windows open to the outdoors on each floor in turn.

References

General

- (1) High-Rise Building Fires and Fire Safety. *Fire Journal and Fire Technology*, NFPA No. SPP-18, 1972, 164 pp.
- (2) N.B. Hutcheon, *Safety in Buildings*. CBD 114, Division of Building Research, National Research Council Canada, Ottawa, June 1969.
- (3) M. Galbreath, *Fire in High Buildings*. DBR Fire Study No. 21, Division of Building Research, National Research Council Canada, Ottawa, April 1968. NRCC 10081.
- (4) G.W. Shorter, *Fire in Tall Buildings*. *Fire Fighting in Canada*, October 1967.

Evacuation

- (5) M. Galbreath, *Time of Evacuation by Stairs in High Buildings*. *Fire Fighting in Canada*, February 1969.
- (6) J.L. Pauls, *Evacuation and Other Fire Safety Measures in High-Rise Buildings*. *ASHRAE Trans.*, Vol. 81, Part 1, 1975, pp. 528-533.

Smoke Movement and Control (General)

- (7) A.G. Wilson and G.W. Shorter, *Fire and High Buildings*. *Fire Technology*, Vol. 6, No. 4, November 1970, pp. 292-304. NRCC 11789.
- (8) J.H. McGuire, G.T. Tamura and A.G. Wilson, *Factors in Controlling Smoke in High Buildings*. *ASHRAE Symposium Bulletin*, January 1970, pp. 8-13. NRCC 12016.
- (9) N.B. Hutcheon and G.W. Shorter, *Smoke Problems in High-Rise Buildings*. *ASHRAE Journal*, Vol. 10, No. 9, September 1968, pp. 57-61. NRCC 10427.
- (10) J.H. McGuire and G.T. Tamura, *Smoke Control in High-Rise Buildings*. CBD 134, Division of Building Research, National Research Council Canada, Ottawa, February 1971.
- (11) G.T. Tamura and J.H. McGuire, *Smoke Movement in High-Rise Buildings*. CBD 133, Division of Building Research, National Research Council Canada, Ottawa, January 1971.
- (12) J.H. McGuire and G.T. Tamura, *The National Building Code Smoke Control Measures - An Overview*. *Engineering Digest*, Vol. 25, No. 9, October 1979, pp. 35-38. NRCC 17920.
- (13) G.T. Tamura, *Review of the DBR/NRC Studies on Control of Smoke from a Fire in High Buildings*. *ASHRAE Trans.* Vol. 89, Part 1B, 1983, pp. 341-361. NRCC 23054.

- (14) G.T. Tamura, Smoke-Control Systems in High-Rise Buildings, 1976-1980 Survey. *Engineering Digest*, Vol. 30, No. 7, August 1984, pp. 32-34. NRCC 23874 .
- (15) G.T. Tamura and P.J. Manley, Smoke Movement Studies in a 15-Storey Hotel. *ASHRAE Trans.*, Vol. 91, Part 2B, 1985, pp. 1237-1253. NRCC 26359.
- (16) J.H. McGuire and G.T. Tamura, Simple Analysis of Smoke-Flow Problems in High Buildings. *Fire Technology*, Vol. 11, No. 1, February 1975, pp. 15-22. NRCC 14773.

Specialized Aspects of Smoke Control

- (17) G.T. Tamura and C.Y. Shaw, Basis for the Design of Smoke Shafts. *Fire Technology*, Vol. 9, No. 3, August 1973, pp. 209-222. NRCC 13851.
- (18) G.T. Tamura and A.G. Wilson, Natural Venting to Control Smoke Movement in Buildings via Vertical Shafts. *ASHRAE Trans.*, Vol. 76, Part II, 1970, pp. 279-289. NRCC 12357.
- (19) G.T. Tamura, Analysis of Smoke Shafts for Control of Smoke Movement in Buildings. *ASHRAE Trans.*, Vol. 76, Part II, 1970, pp. 290-297. NRCC 12356 .
- (20) G.T. Tamura, J.H. McGuire and A.G. Wilson, Air-Handling Systems for Control of Smoke Movement. *ASHRAE Symposium Bulletin*, January 1970, pp. 14-19. NRCC 12017.
- (21) N.B. Hutcheon, Fire Protection in Air System Installations. *Heating, Piping and Air Conditioning*, Vol. 40, No. 12, December 1968, p. 102. NRCC 10545.
- (22) G.T. Tamura and C.Y. Shaw, Experimental Studies of Mechanical Venting for Smoke Control in Tall Office Buildings. *ASHRAE Trans.*, Vol. 84, Part 1, 1978, pp. 54-71. NRCC 17234.
- (23) G.T. Tamura, Experimental Studies on Exterior Wall Venting for Smoke Control in Tall Office Buildings. *ASHRAE Trans.*, Vol. 84, Part 2, 1978, pp. 204-215. NRCC 17279.
- (24) G.T. Tamura, The Performance of a Vestibule Pressurization for the Protection of Escape Routes of a 17-Storey Hotel. *ASHRAE Trans.*, Vol. 86, Part 1, 1980, pp. 593-603. NRCC 19017.
- (25) G.T. Tamura and C.Y. Shaw, Field Check on the Building Pressurization Method for Smoke Control in High-Rise Buildings. *ASHRAE Journal*, Vol. 23, No. 2, February 1981, pp. 21-25. NRCC 19199.
- (26) G.T. Tamura, A Smoke Control System for High-Rise Office Buildings. *ASHRAE Journal*, Vol. 24, No. 5, May 1982, pp. 29-32. NRCC 20317.
- (27) G.T. Tamura and K. Tsuji, Simplified Method for Designing a Mechanical Smoke Exhaust System for High-Rise Buildings. *ASHRAE Trans.*, Vol. 91, Part 2 B, 1985, pp. 642-656. NRCC 26341.
- (28) G.T. Tamura, Experimental Studies on Pressurized Escape Routes. *ASHRAE Trans.*, Vol. 80, Part 2, 1974, pp. 224-237. NRCC 14566.
- (29) G.T. Tamura and J.H. Klote, Experimental Fire Tower Studies of Elevator Pressurization Systems for Smoke Control. *ASHRAE Trans.* Vol. 93, Part 2, 1987. NRCC 29121.
- (30) J.H. Klote and G.T. Tamura, Experiments of Piston Effect on Elevator Smoke Control. *ASHRAE Trans.* Vol. 93, Part 2, 1987. NRCC 29120.

Computer Studies

- (31) H. Yoshida, C.Y. Shaw and G.T. Tamura, A Fortran IV Program to Calculate Smoke Concentrations in a Multi-Storey Building. *Computer Program No. 45*, Division of Building Research, National Research Council Canada, Ottawa, June 1979.
- (32) G.T. Tamura, Computer Analysis of Smoke Control with Building Air Handling Systems. *ASHRAE Journal*, Vol. 14, No. 8, August 1972, pp. 46-54. NRCC 12809.
- (33) C.Y. Shaw and G.T. Tamura, Fortran IV Programs for Calculating Sizes and Venting Capacities of Smoke Shafts. *Computer Program No. 36*, Division of Building Research, National Research Council Canada, Ottawa, June 1973 .
- (34) G.T. Tamura, Computer Analysis of Smoke Movement in Tall Buildings. *ASHRAE Trans.*, Vol. 75, Part II, 1969, pp. 81-92. NRCC 11542.

Air Leakage Studies

- (35) C.Y. Shaw, D.M. Sander and G.T. Tamura, Air Leakage Measurements of the Exterior Walls of Tall Buildings. *ASHRAE Trans.*, Vol. 79, Part II, 1973, pp. 40-48. NRCC 13951.

- (36) G.T. Tamura and A.G. Wilson, Pressure Differences Caused by Wind on Two Tall Buildings. ASHRAE Trans., Vol. 74, Part II, 1968, pp. 170-181. NRCC 10628.
- (37) G.T. Tamura and A.G. Wilson, Pressure Differences Caused by Chimney Effect in Three High Buildings and Building Pressures Caused by Chimney Action and Mechanical Ventilation. ASHRAE Trans., Vol. 73, Part II, 1967. NRCC 9950.
- (38) G.T. Tamura and A.G. Wilson, Pressure Differences for a Nine-Storey Building as a Result of Chimney Effect and Ventilation System Operation. ASHRAE Trans., Vol. 72, Part I, 1966, pp. 180-189. NRCC 9467.
- (39) G.T. Tamura and C.Y. Shaw, Air Leakage Data for the Design of Elevator and Stair shaft Pressurization Systems. ASHRAE Trans., Vol. 82, Part II, 1976, pp. 179-190. NRCC 15921.

Associated Elementary Theory

- (40) A.G. Wilson and G.T. Tamura, Stack Effect and Building Design. CBD 107, Division of Building Research, National Research Council Canada, Ottawa, November 1968.
- (41) A.G. Wilson and G.T. Tamura, Stack Effect in Buildings. CBD 104, Division of Building Research, National Research Council Canada, Ottawa, August 1968.

^{es} MMA Supplementary Standard SB-5

Reserved

July 1, 2017 update

MMAH Supplementary Standard SB-6

Percolation Time and Soil Descriptions

September 14, 2012

COMMENCEMENT

MMAH Supplementary Standard SB-6 comes into force on the 1st day of January, 2014.

© Copyright

© Copyright Queen's Printer for Ontario 2012

All rights reserved.

Questions regarding copyright, including reproduction and distribution, may be directed to the Director,
Building and Development Branch of the Ministry of Municipal Affairs and Housing.

SB-6 Percolation Time and Soil Descriptions

ESTIMATION OF PERCOLATION TIME

- (a) The purpose of this Section and the associated Tables and Charts is to provide assistance to those who must decide on the percolation time(s) to be used in design. Suggested relationships between percolation time, coefficient of permeability and soils of various types are given. **IT MUST BE EMPHASIZED THAT, PARTICULARLY FOR FINE GRAINED SOILS, THERE IS NO CONSISTENT RELATIONSHIP DUE TO THE MANY FACTORS INVOLVED.** The following guidance is presented for the soil types outlined in the Unified Soil Classification System (Table 1). In order to assess a particular soil.
- (i) Table 2 and Table 3 - Approximate relationship of soil types to permeability and percolation time.
 - (ii) Charts 1 to 14 - Typical grain size distribution curves for soil types in the Unified Soil Classification System.
- (b) In Table 2 and Table 3, a range of values of “K” and of “T” are given for various soil descriptions. The principal modifiers which will influence selection of a “T” value within the range given are:
- (i) The structure - “massive” fine-grained soils have high values of “T”.
 - (ii) The density - For a given soil higher density produces a higher value of “T”.
 - (iii) The percentage of clay - the higher the percentage the higher the value of “T”.
 - (iv) The mineralogy of the clay portion - The more it “swells” the higher the value of “T”.
 - (v) The plasticity of the soil - The higher the plasticity index the higher the value of “T”.
 - (vi) Liquid Limit - the higher the liquid limit the higher the value of “T”.
 - (vii) Organic content - The presence of fine organic particles, detectable by colouration and odour, can significantly reduce the permeability and raise the value of “T”.

Table 1
Unified Soil Classification

Coarse - Grained Soils		Fine - Grained Soils	
Group Symbols	Typical Names	Group Symbols	Typical Names
GW	Well-graded gravels, gravel-sand mixtures, little or no fines	ML	Inorganic silts and very fine sands, rock flour, silty or clayey fine sands or clayey silts with slight plasticity
GP	Poorly-graded gravels, gravel-sand mixtures, little or no fines	CL	Inorganic clays of low to medium plasticity, gravelly clays, sandy clays, silty clays, lean clays
GM	Silty gravels, gravel-sand-silt mixtures	OL	Organic silts and organic silty clays of low plasticity
GC	Clayey gravels, gravel-sand-clay mixtures	MH	Inorganic silts, micaceous or diatomaceous fine sandy or silty soils, elastic silts
SW	Well-graded sands, gravelly sands, little or no fines	CH	Inorganic clays of high plasticity, fat clays
SP	Poorly-graded sands, gravelly sands, little or no fines	OH	Organic clays of medium to high plasticity, organic silts
SM	Silty sands, sand-silt mixtures		
SC	Clayey sands, sand-clay mixtures	PT (highly organic soils)	Peat and other highly organic soils
Column 1	2	3	4

Table 2
Approximate Relationship of Coarse Grained Soil Types to Permeability and Percolation Time

Soil Type (Unified Soil Classification)	Coefficient of Permeability, K - cm/sec	Percolation Time, T - mins/cm	Comment
Coarse Grained More than 50% Larger than #200			
G.W. - Well graded gravels, gravel-sand mixtures, little or no fines.	10^{-1}	<1	very permeable unacceptable
G.P. - Poorly graded gravels, gravel-sand mixtures, little or no fines.	10^{-1}	<1	very permeable unacceptable
G.M. - Silty gravels, gravel-sand-silt mixtures.	$10^{-2} - 10^{-4}$	4 - 12	Permeable to medium permeable depending on amount of silt.
G.C. - Clayey gravels, gravel-sand-clay mixtures.	$10^{-4} - 10^{-6}$	12 - 50	Important to estimate amount of silt and clay
S.W. - Well graded sands, gravelly sands little or no fines.	$10^{-1} - 10^{-4}$	2 - 12	medium permeability
S.P. - Poorly graded sands, gravelly sand, little or no fines.	$10^{-1} - 10^{-3}$	2 - 8	medium permeability
S.M. - Silty sands, sand-silt mixtures.	$10^{-3} - 10^{-5}$	8 - 20	medium to low permeability
S.C. - Clayey sands, sand-clay mixtures.	$10^{-4} - 10^{-6}$	12 - 50	medium to low permeability depending on amount of clay
Column 1	2	3	4

Table 3
Approximate Relationship of Coarse Grained Soil Types to Permeability and Percolation Time

Soil Type (Unified Soil Classification)	Coefficient of Permeability, K - cm/sec	Percolation Time, T - mins/cm	Comment
Fine Grained More than 50% Passing #200			
M.L. - Inorganic silts and very fine sands, rock flour, silty or clayey fine sands, clayey silts with slight plasticity	10^{-5} - 10^{-6}	20 - 50	medium to low permeability
C.L. - Inorganic clays of low to medium plasticity, gravelly clays, sandy clays, silty clays, lean clays	10^{-6} and less	over 50	unacceptable
O.L. - Organic silts, organic silty clays of low plasticity; liquid limit less than 50	10^{-5} and less	20 - over 50	acceptable depends on clay content
M.H. - Inorganic silts, micaceous or diatomaceous fine sandy or silty soils, elastic silts	10^{-6} and less	over 50	unacceptable
C.H. - Inorganic clays of medium to high plasticity, organic silts	10^{-7} and less	over 50	unacceptable
O.H. - Organic clays of medium to high plasticity organic silt; liquid limit over 50	10^{-6} and less	over 50	unacceptable
Column 1	2	3	4

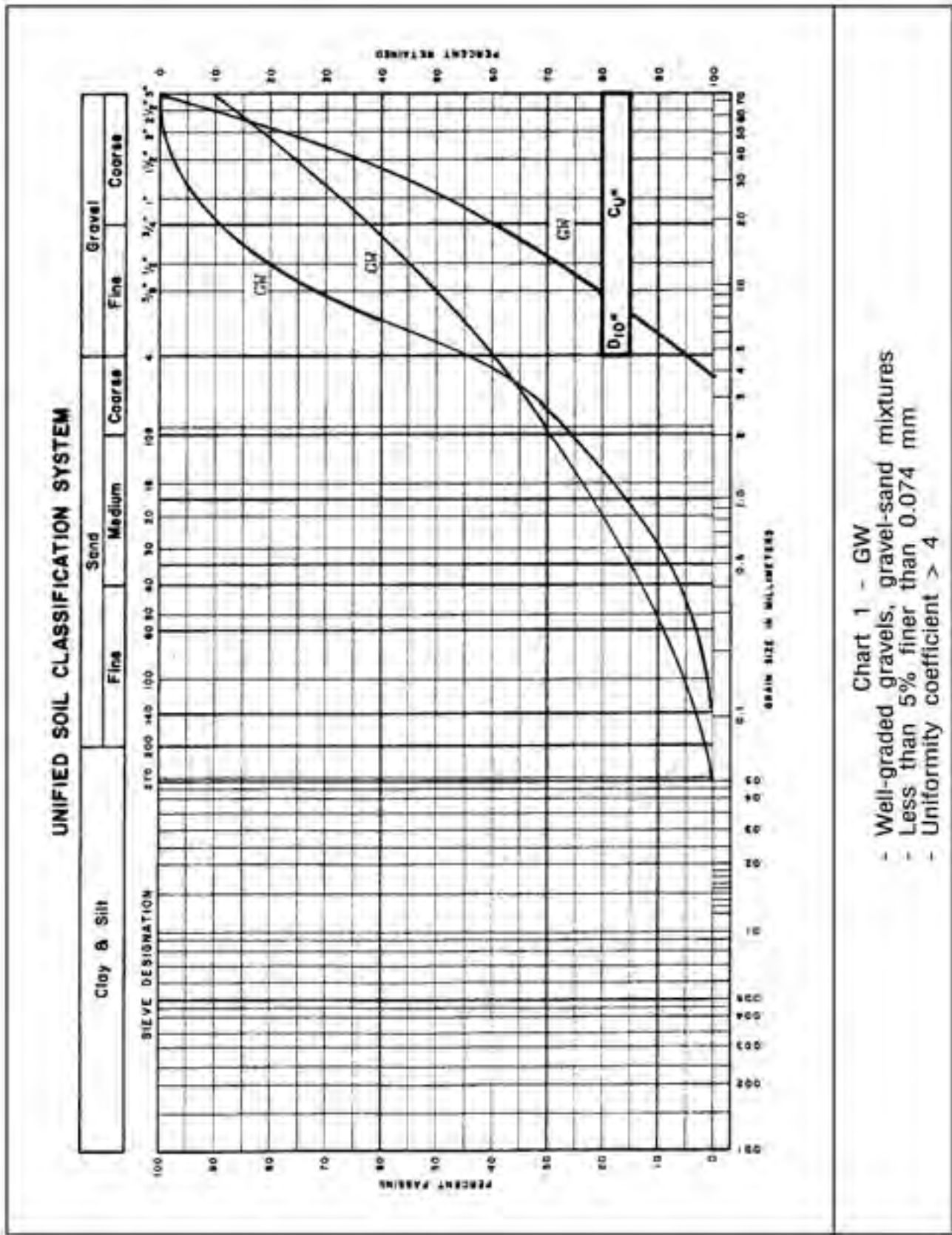
SELECTION OF “T” TIME FROM THE ABOVE TABULATION

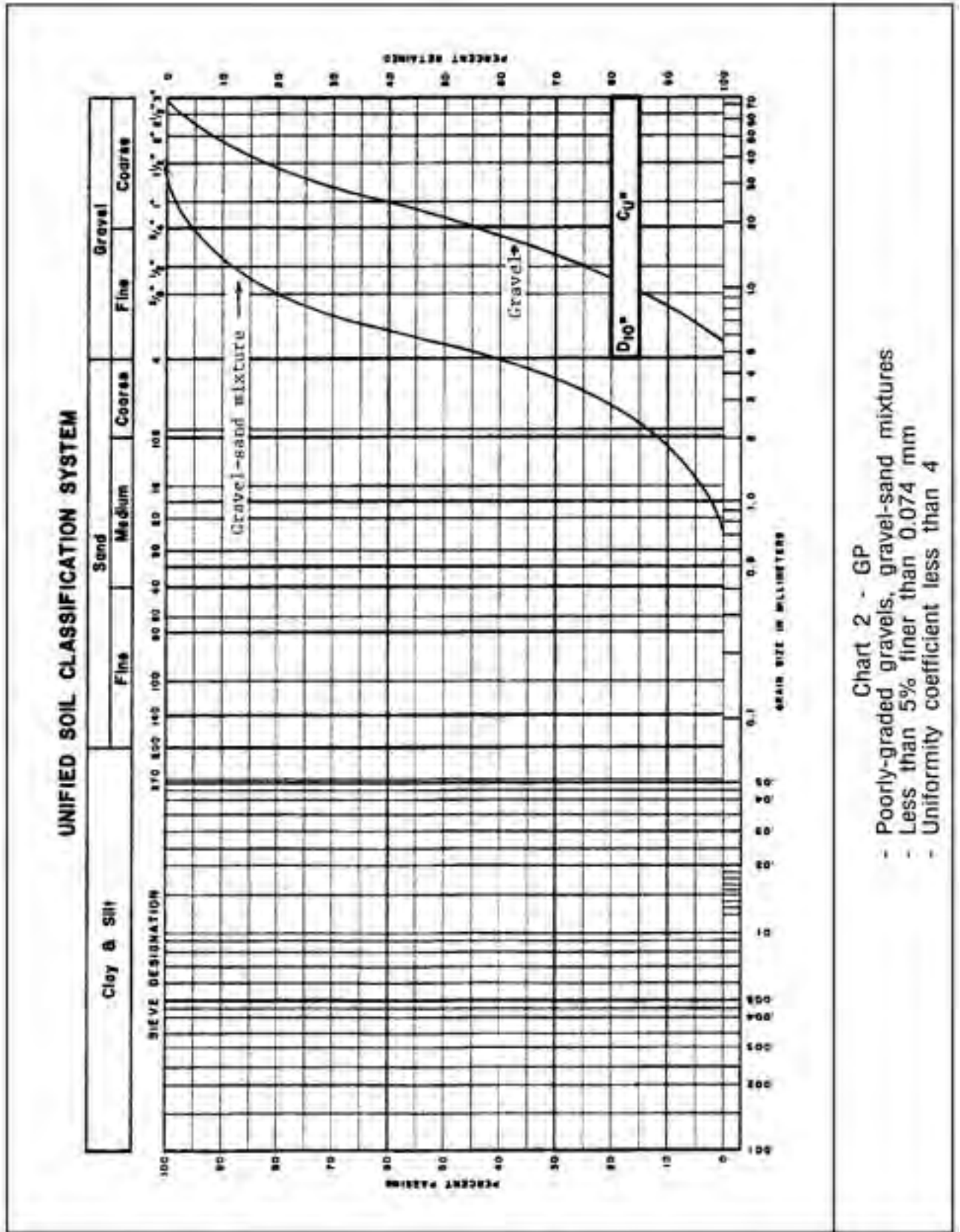
A range of “T” times for each soil type is shown above. Select from within this range by determining if the soil is within the low, middle or high part of the range considering the soil identifiers and soil characteristics. Consider structure, density, colour, prevalence or organics, the clay content and mineralogy, the plasticity index and liquid limit and the functioning of existing systems in similar soils in the area.

Notes:

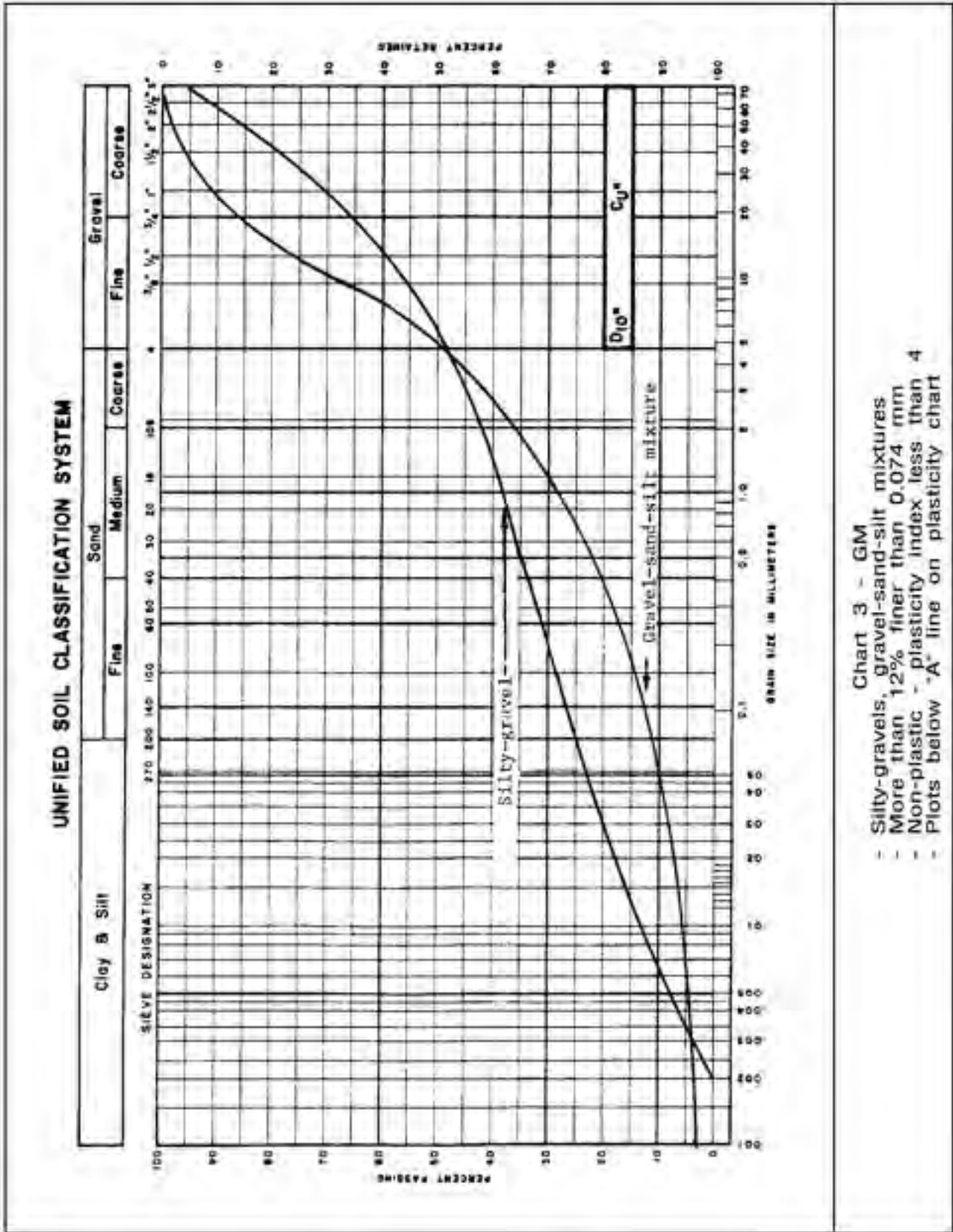
The following Ministry of the Environment Reports provide further information on the relationship between grain size, coefficient of permeability and percolation time.

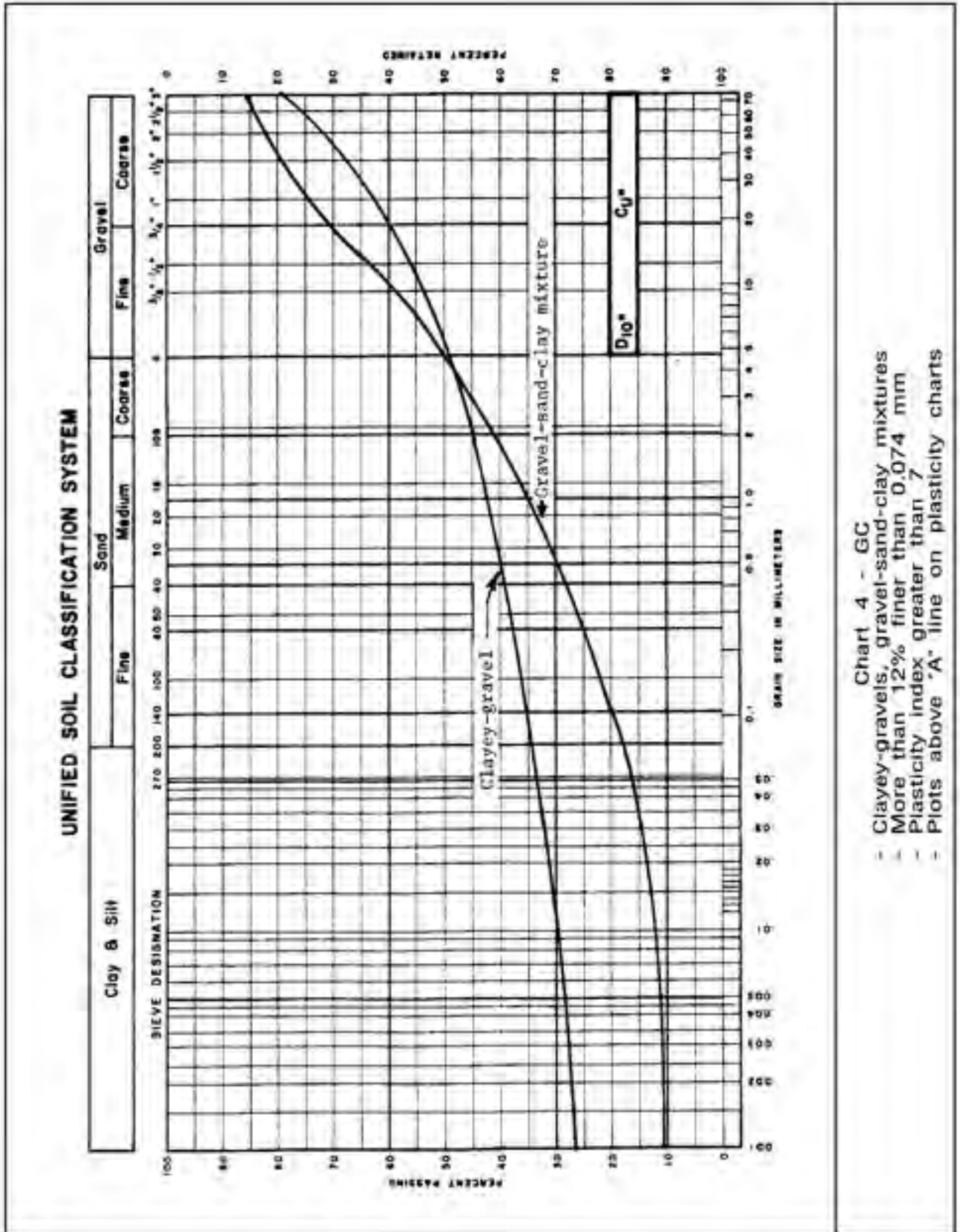
1. “Study on the Feasibility of Correlating Percolation Time with Laboratory Permeability” - 1975 - Research Report No. S56 by H. T. Chan, PhD., P.Eng.
2. “Study of Conventional Tile Fields in Fine-Grained Soils” - 1979 Research Report 74 by H. T. Chan, PhD., P.Eng.

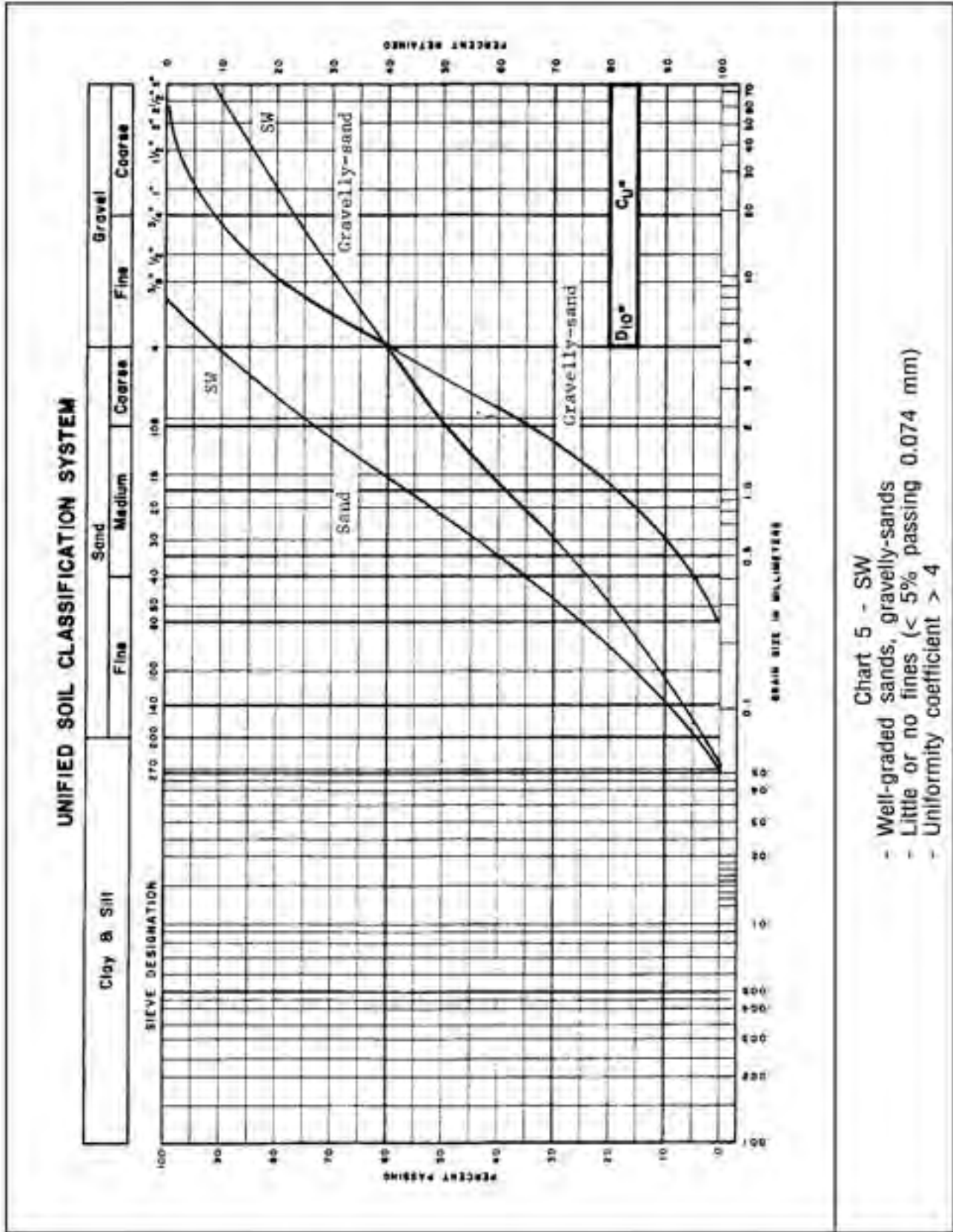


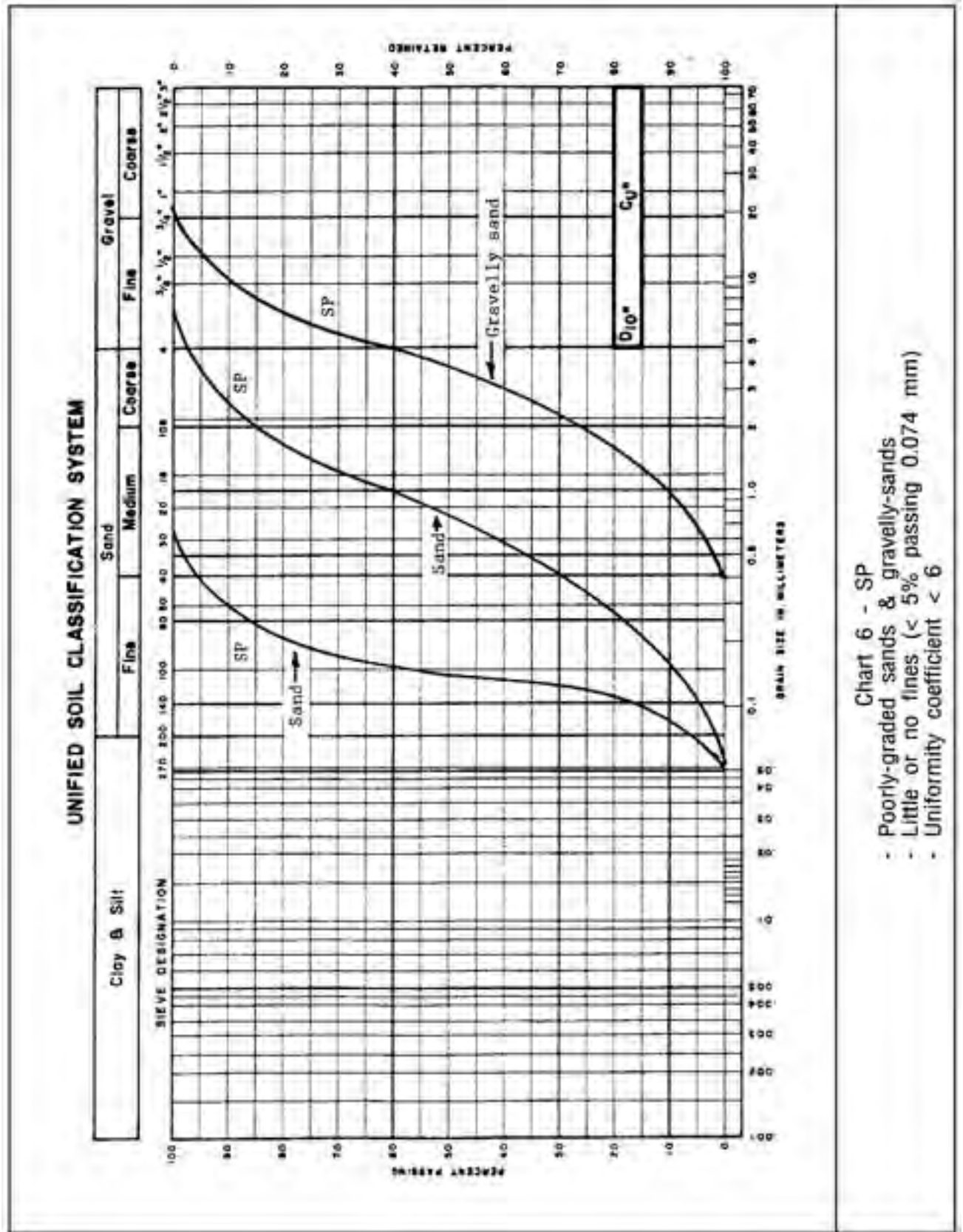


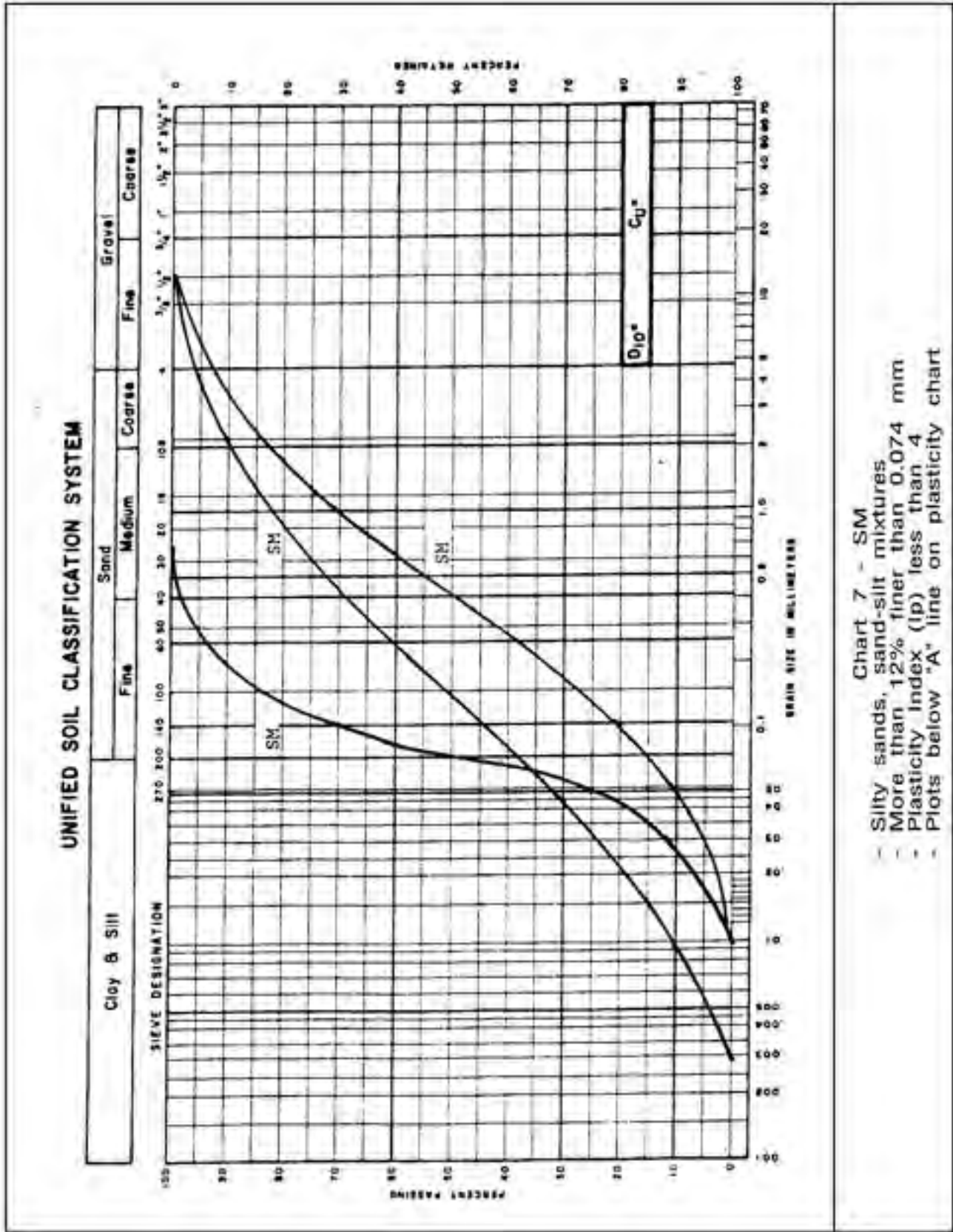
- Chart 2 - GP
- Poorly-graded gravels, gravel-sand mixtures
 - Less than 5% finer than 0.074 mm
 - Uniformity coefficient less than 4

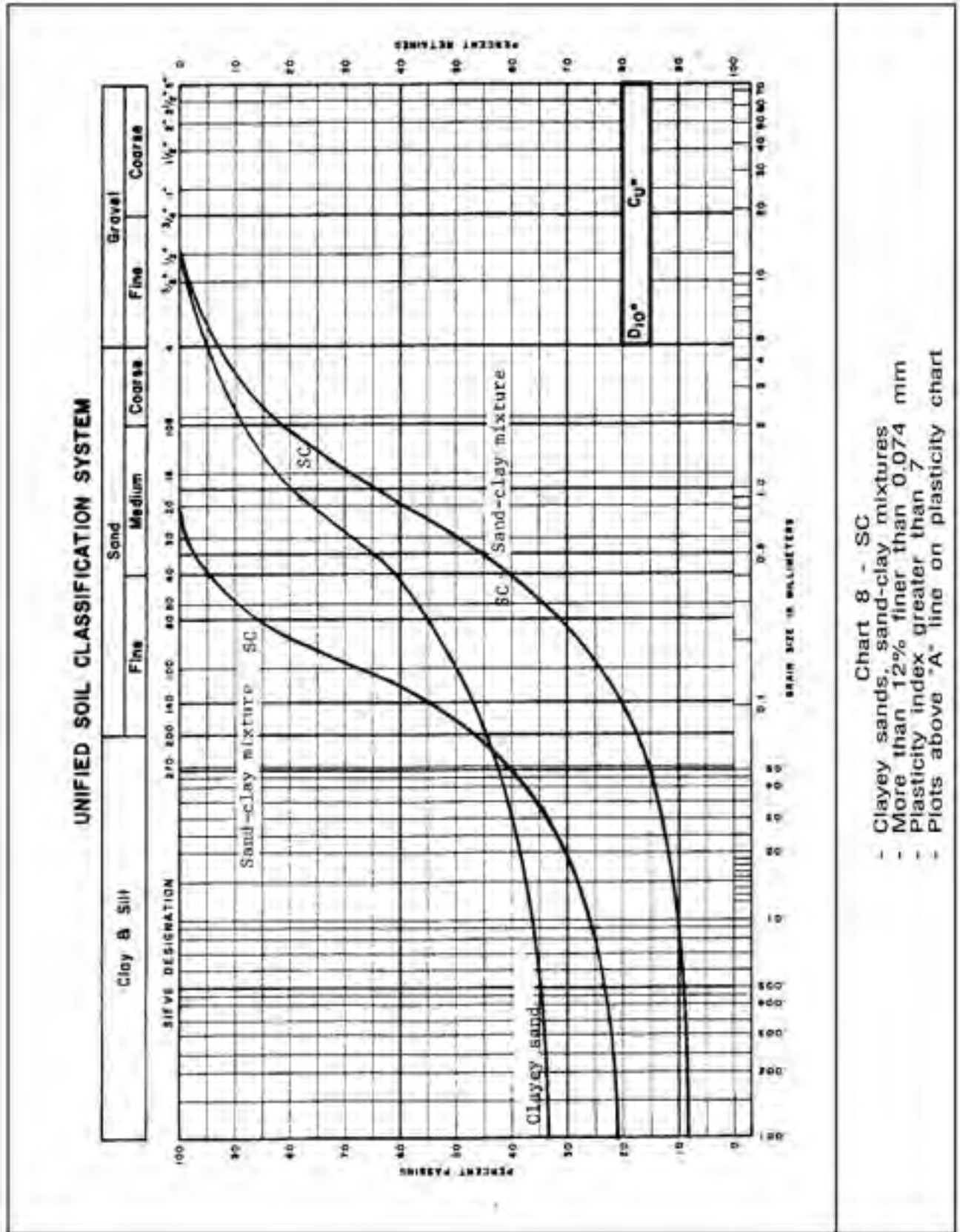












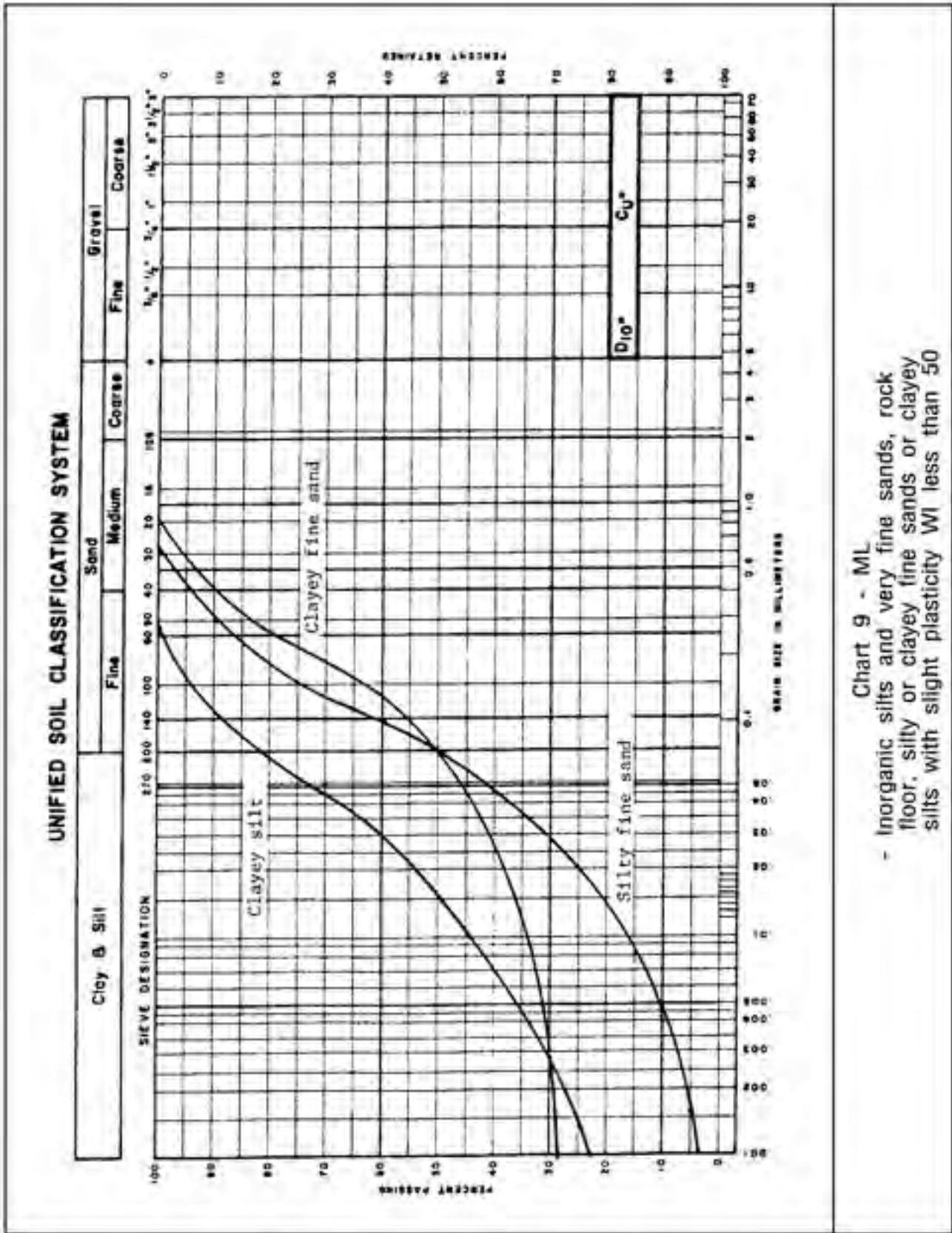
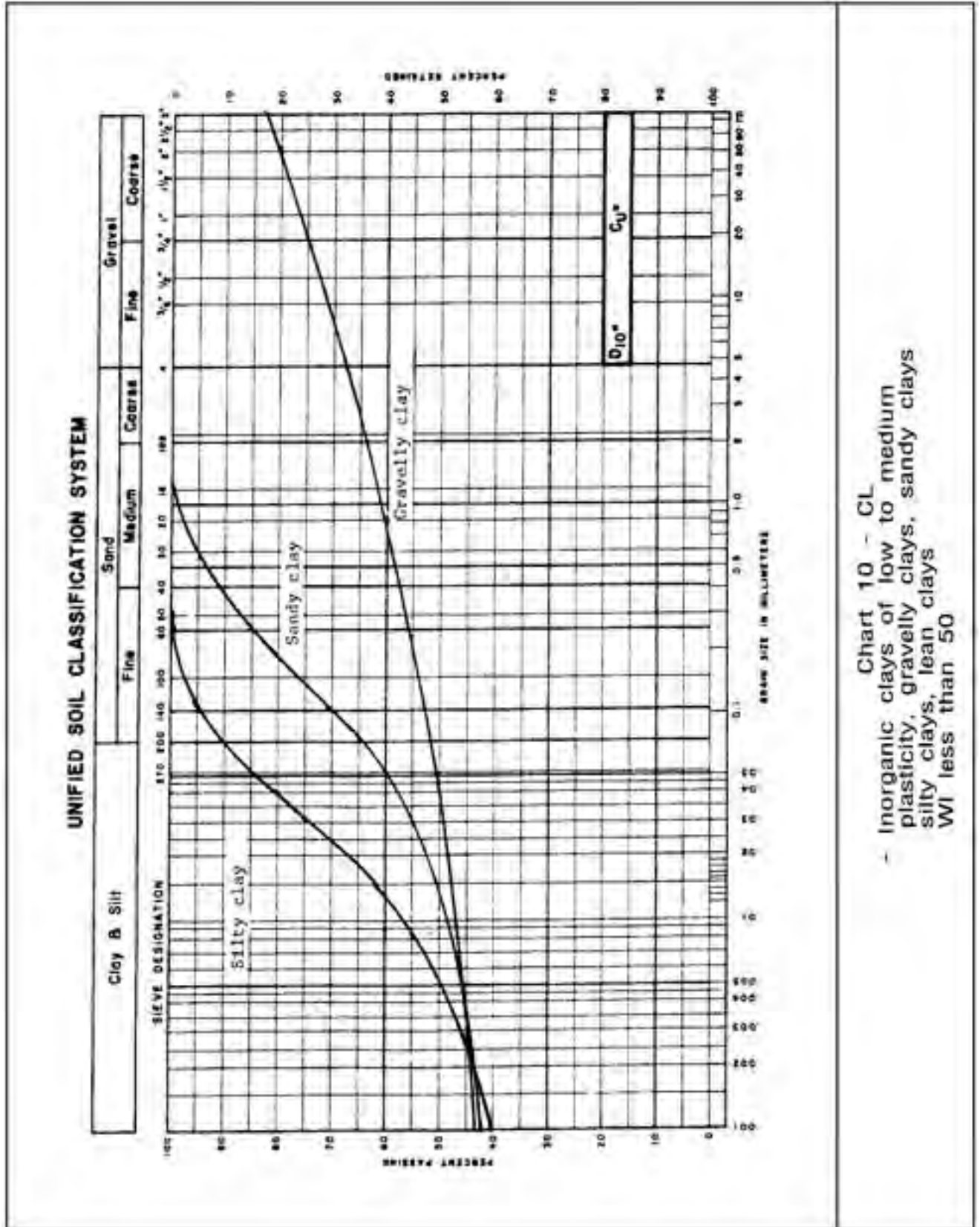


Chart 9 - ML
 - Inorganic silts and very fine sands, rock floor, silty or clayey fine sands or clayey silts with slight plasticity W_I less than 50



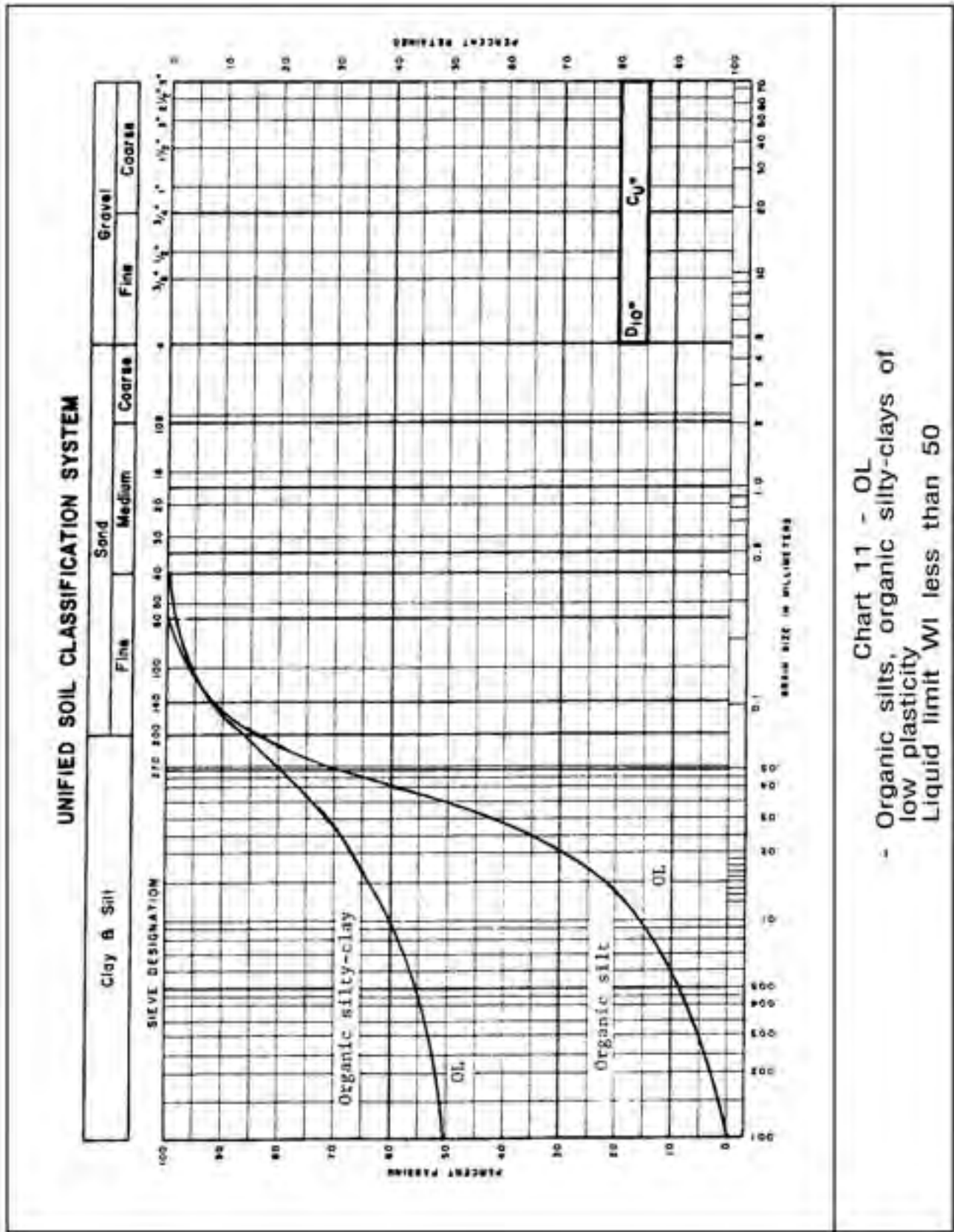


Chart 11 - OL
 - Organic silts, organic silty-clays of low plasticity
 Liquid limit W_L less than 50

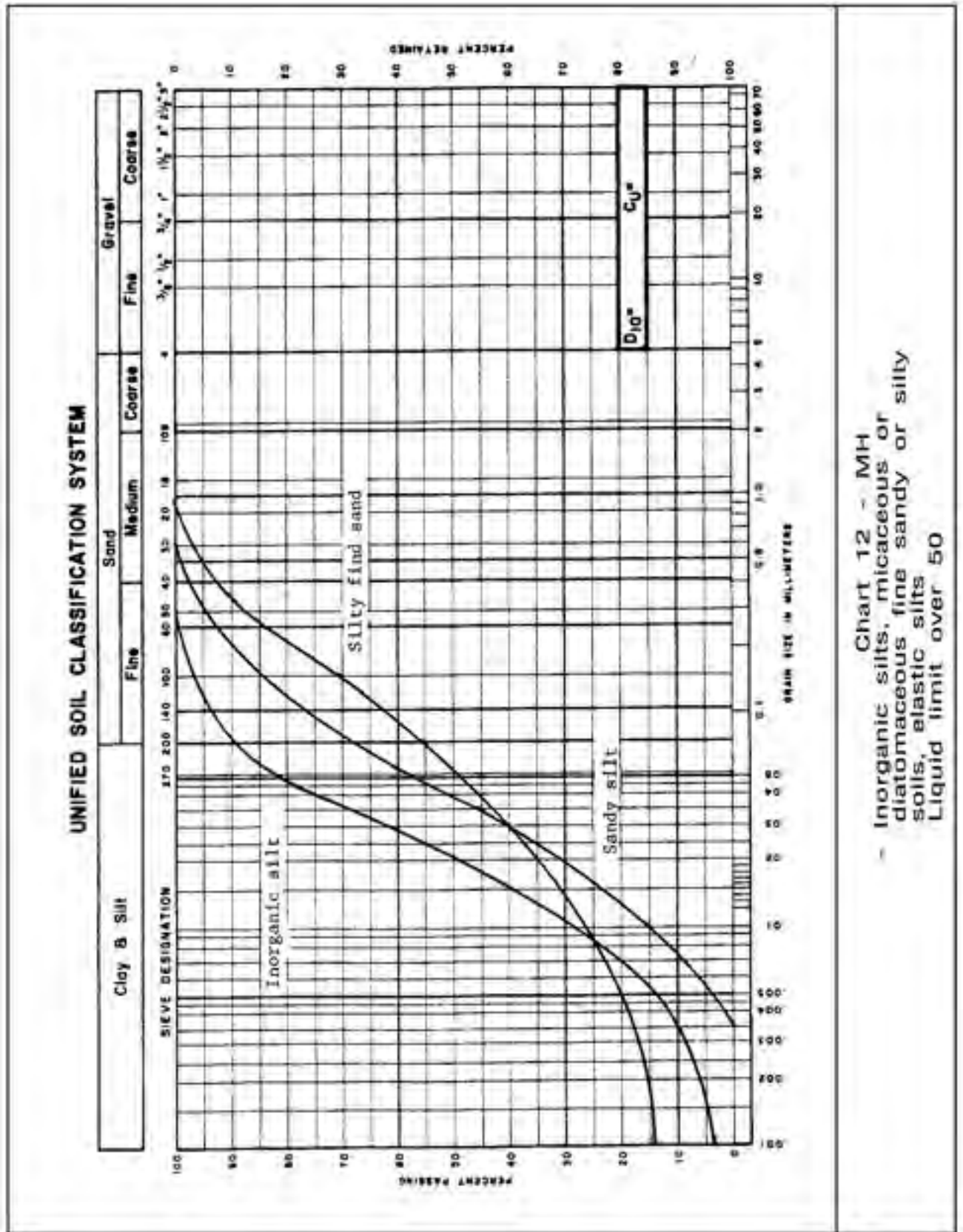


Chart 12 - MH
 - Inorganic silts, micaceous or diatomaceous fine sandy or silty soils, elastic silts
 Liquid limit over 50

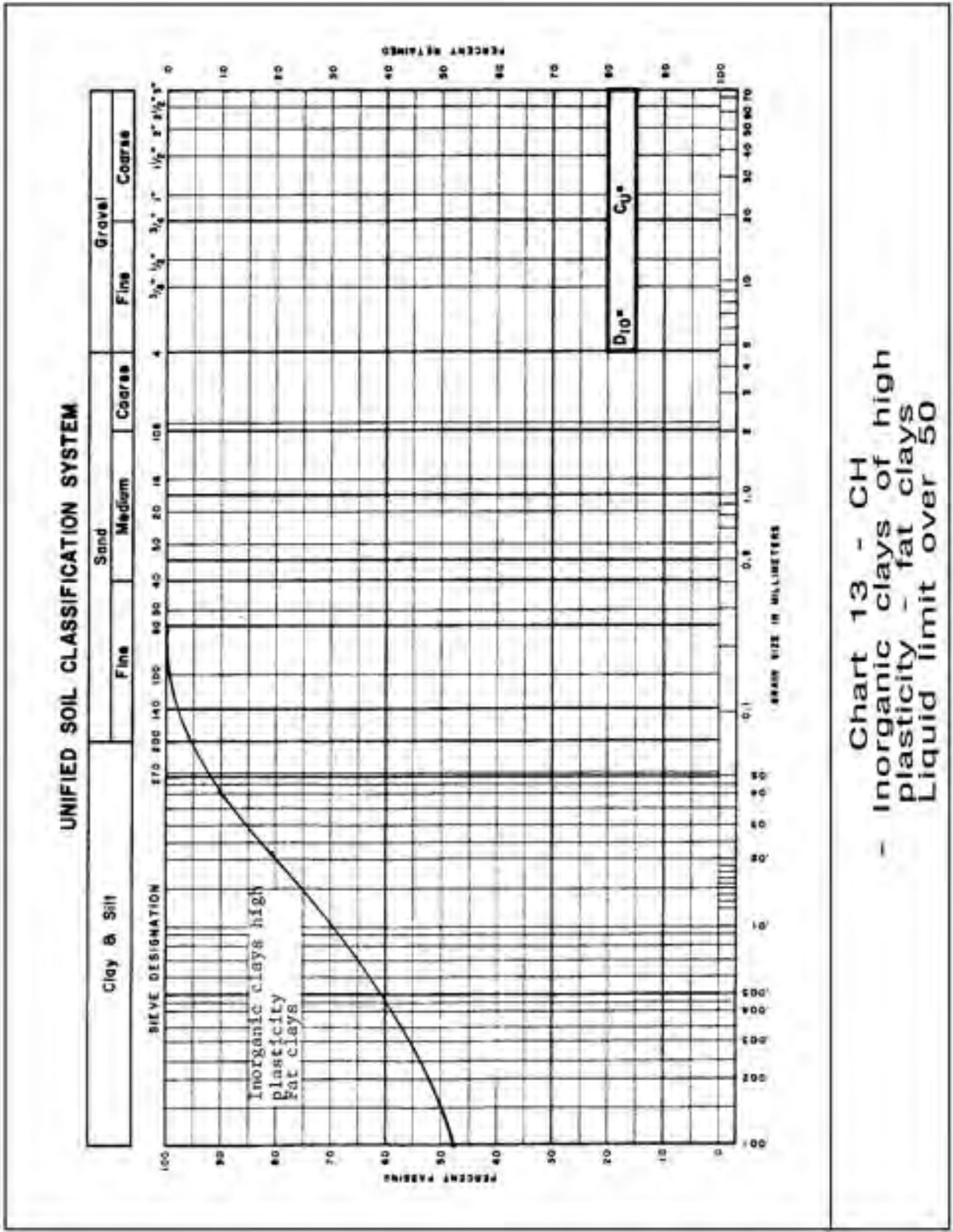


Chart 13 - CH

- Inorganic clays of high plasticity - fat clays

Liquid limit over 50

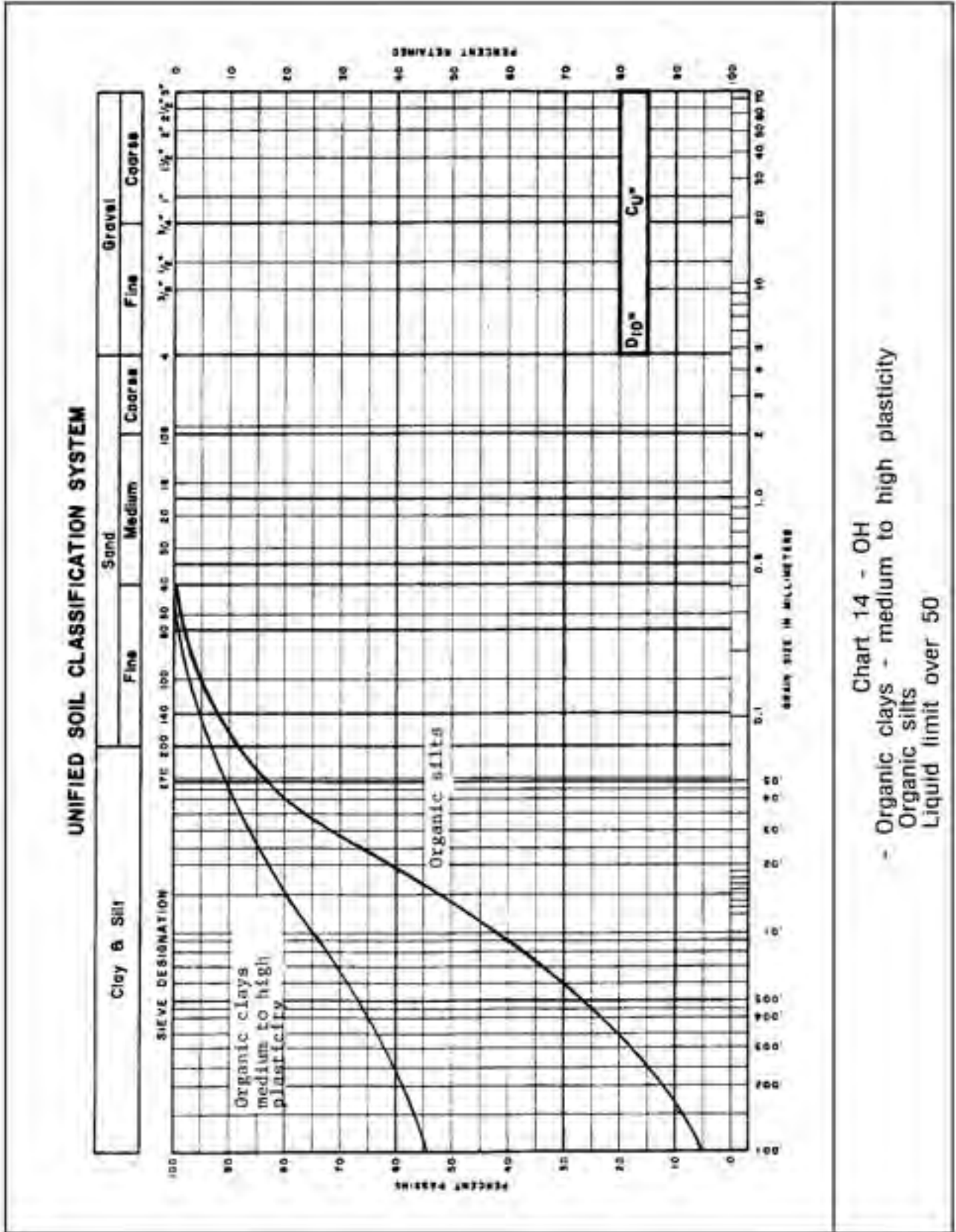


Chart 14 - OH
 - Organic clays - medium to high plasticity
 Organic silts
 Liquid limit over 50

MMAH Supplementary Standard SB-7

Guards for Housing and Small Buildings

September 14, 2012

COMMENCEMENT

MMAH Supplementary Standard SB-7 comes into force on the 1st day of January, 2014.

© Copyright

© Copyright Queen's Printer for Ontario 2012

All rights reserved.

Questions regarding copyright, including reproduction and distribution, may be directed to the Director,
Building and Development Branch of the Ministry of Municipal Affairs and Housing.

SB-7 Guards for Housing and Small Buildings

Section 1 General

1.1. Introduction

1.1.1. Scope (See Appendix A.)

- (1) This Supplementary Standard includes details for the construction of wood guards.
- (2) Guards located on the exterior of a building, where they may be subject to deterioration, shall be constructed in accordance with Section 2 of this Supplementary Standard. (See Appendix A.)
- (3) Guards located inside a building shall be constructed in conformance with Section 2 or Section 3 of this Supplementary Standard.

1.2. Design of Guards

1.2.1. Cantilever Action (See Appendix A.)

- (1) The construction details for guards in this Supplementary Standard are based on the assumption that the guard acts as a cantilever in resisting lateral loads.

1.2.2. Classification (See Appendix A.)

- (1) The structural systems of guards described in this Supplementary Standard are grouped into the following classifications:
 - (a) Post and Rail Systems, and
 - (b) Cantilevered Picket Systems.

Section 2 Exterior Guards

2.1. Materials

2.1.1. Lumber Grades (See Appendix A)

- (1) The minimum grade of softwood dimension lumber for posts, rails and joists shall be Northern Species, No. 2.
- (2) The minimum grade of softwood dimension lumber for pickets shall be Northern Species, No. 2 Picket grade.
- (3) Wood for pickets shall be free of loose knots.

2.1.2. Lumber Dimensions

(1) Except as permitted in Sentence (2), the minimum sizes of loadbearing elements of wood guards shall conform to Table 2.1.2.

Table 2.1.2.
Minimum Size of Loadbearing Elements

Guard Element	Minimum Size, mm (in)
Post	89 x 89 (4" x 4" nominal)
Top Rail	38 x 89 (2" x 4" nominal)
Bottom Rail	38 x 89 (2" x 4" nominal)
Picket / Baluster	32 x 32 (1 ⁹ / ₃₂ " x 1 ⁹ / ₃₂ ")
Column 1	2

(2) Where a bottom rail is bevelled, the minimum sizes shown in Table 2.1.2. may be reduced to allow for a bevel, as detailed in Figure 2.1.2.

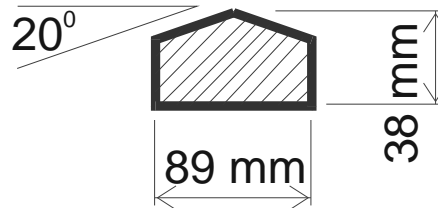


Figure 2.1.2.
Bevel Detail

2.1.3. Floor Construction (See Appendix A.)

(1) The minimum dimensions of wood floor joists and wood decking shall conform to Table 2.1.3.

(2) Except as provided in Details EA-1 to ED-5, wood decking shall be fastened to each floor joist with nailing conforming to Table 2.1.3.

Table 2.1.3.
Minimum Size of Floor Elements

Floor Element	Minimum size, mm (in)
Dimension Lumber Decking	25 x 140 (⁵ / ₄ " x 6" nominal), when each plank is fastened with 2 - 63 mm (2½") nails
	38 x 89 (2" x 4" nominal), when each plank is fastened with 2 - 76 mm (3") nails
Dimension Lumber Joists	38 x 184 (2" x 8" nominal)
Column 1	2

2.1.4. Connectors (See Appendix A.)

- (1) Nails, screws, lag bolts and machine bolts shall not cause splitting of wood elements.
- (2) Fasteners shall be resistant to corrosion.
- (3) All nails shall be common spiral.

(See also A-2.1.4. in Appendix A for glued joints.)

2.1.5. Decay-Resistant Lumber (See Appendix A.)

- (1) Lumber for guard systems and floor systems shall be
 - (a) a species resistant to decay,
 - (b) preservative treated to prevent decay, or
 - (c) pressure-treated.
- (2) All cut ends of preservative treated lumber shall be treated to prevent decay.

2.2. Structural Details

2.2.1. Post and Rail System

- (1) An exterior guard constructed as a Post and Rail System shall conform to the applicable connection details listed in Table 2.2.1.

2.2.2. Cantilevered Picket System

- (1) An exterior guard constructed as a Cantilevered Picket System shall conform to the applicable connection details listed in Table 2.2.2.

Table 2.2.1.
Exterior Post and Rail System Connection Details

Connection Detail	Detail Number	Description
Top Rail to Post and / or Bottom Rail to Post	EA-1	Top rail nailed to post
	EA-2	Top/bottom rail skew nailed to post with 76 mm (3") nails
	EA-3	Top/bottom rail skew nailed to post with 63 mm (2½") nails
	EA-4	Top/bottom rail face nailed or screwed to post
	EA-5	Top/bottom rail fastened to post with framing anchors
Post to Floor	EB-1	Post nailed to rim joist
	EB-2	Post screwed to rim joist
	EB-3	Post bolted to floor joist with 8 mm (⁵ / ₁₆ ") machine bolts
	EB-4	Post bolted to floor joist with 9.5 mm (³ / ₈ ") machine bolts
	EB-5	Post bolted to 2 floor joists
	EB-6	Post fastened to floor, where guard is parallel to floor joists
Infill Picket	EC-1	Picket nailed to endcap; endcap screwed to rail
	EC-2	Picket nailed to rail
	EC-3	Picket screwed to rail
	EC-4	Picket screwed to top rail and rim joist
Column 1	2	3

Table 2.2.2.
Exterior Cantilevered Picket System Connection Details

Connection Detail	Detail Number	Description
Cantilevered Picket (Douglas Fir-Larch, Spruce-Pine-Fir, Hem-Fir Species)	ED-1	Picket screwed to rim joist
	ED-2	Picket screwed to rim joist, where guard is parallel to floor joists
Cantilevered Picket (Northern Species)	ED-3	Picket screwed to rim joist and deck
	ED-4	Picket screwed to rim joist and deck, where guard is parallel to floor joists
Cantilevered Picket (Douglas Fir-Larch, Spruce-Pine-Fir, Hem-Fir Species, Northern Species)	ED-5	Corner
Column 1	2	3

Section 3 Interior Guards

3.1. Materials

3.1.1. Lumber and Wood Products

- (1) Lumber species used for a primary loadbearing element in a guard shall be a species listed in the Table 3.1.2.
- (2) Except as provided in Sentence (4), the minimum grade of softwood dimension lumber for posts, rails and joists shall be Northern Species, No. 2.
- (3) Except as provided in Sentence (4), the minimum grade of softwood dimension lumber for cantilevered pickets shall be Northern Species, No. 2 Picket grade.
- (4) White pine and hemlock lumber used for posts, rails and non-cantilevered pickets shall be clear straight grain material.
- (5) Oak, maple and yellow poplar lumber used for posts, rails and pickets shall be clear straight grain material.

3.1.2. Lumber Dimensions

- (1) The minimum sizes of loadbearing elements of wood guards shall conform to Table 3.1.2.

3.1.3. Floor Construction

- (1) The minimum dimensions of wood floor joists and wood subflooring shall conform to Table 3.1.3. (See A-2.1.3. in Appendix A.)

3.1.4. Connectors

- (1) Nails, screws, lag bolts and machine bolts shall not cause splitting of the wood elements. (See A-2.1.4. in Appendix A.) (See also A-2.1.4. in Appendix A for glued joints.)

3.2. Structural Details

3.2.1. Post and Rail System

- (1) An interior guard constructed as a Post and Rail System shall conform to the applicable connection details listed in Table 3.2.1.

3.2.2. Cantilevered Picket System

- (1) An interior guard constructed as a Cantilevered Picket System shall conform to the applicable connection details listed in Table 3.2.2.

3.2.3. Guards for Stairs

- (1) An interior guard for a stair shall conform to the appropriate connection details listed in Table 3.2.3.

Table 3.1.2.
Minimum Size of Loadbearing Elements

Guard Element	Species	Minimum Size, mm (in)	Detail Number ⁽¹⁾
Post	Oak, Maple	70 x 70 (2 ³ / ₄ " x 2 ³ / ₄ ") Base, 45 (1 ³ / ₄ ") Turned Diameter	IB-1, IG-1, IG-2, IG-3
	Hemlock, White Pine, Yellow Poplar	82 x 82 (3 ¹ / ₄ " x 3 ¹ / ₄ ") Base, 50 (2") Turned Diameter	IB-1, IG-1, IG-2, IG-3
Post in a Volute	Oak, Maple	70 x 70 (2 ³ / ₄ " x 2 ³ / ₄ ") Base, 50 (2") Turned Diameter	IG-4
Top Rail	Oak, Maple	41 x 67 (1 ⁵ / ₈ " x 2 ⁵ / ₈ ")	IA-1, IF-1
Bottom Rail	Oak, Maple	41 x 67 (1 ⁵ / ₈ " x 2 ⁵ / ₈ ") 19 x 67 (3/4" x 2 ⁵ / ₈ "), if continuously supported	
Infill Picket	Oak, Maple	20 (3/4") Diameter	IC-1, IC-2
	Yellow Poplar	22 (7/8") Diameter	
	White Pine, Hemlock	24 (3 ¹ / ₃₂ ") Diameter	
Picket in a Volute	Oak, Maple	32 x 32 (1 ⁹ / ₃₂ " x 1 ⁹ / ₃₂ ") Base, 20 (3/4") Turned Diameter	IG-4
	Yellow Poplar	45 x 45 (1 ³ / ₄ " x 1 ³ / ₄ ") Base, 22 (7/8") Turned Diameter	IG-5, IG-6
	White Pine, Hemlock	45 x 45 (1 ³ / ₄ " x 1 ³ / ₄ ") Base, 24 (3 ¹ / ₃₂ ") Turned Diameter	
Cantilevered Picket	Northern Species, Douglas Fir-Larch, Spruce-Pine-Fir, Hem-Fir, Hardwood	32 x 32 (1 ⁹ / ₃₂ " x 1 ⁹ / ₃₂ ")	IE-1, IH-1
Column 1	2	3	4

Notes to Table 3.1.2.:

1. This column lists details that incorporate the guard elements specified in this Table.

Table 3.1.3.
Minimum Size of Floor Elements

Floor Element	Minimum size, mm (in)
Subfloor	15.5 (5/8") plywood or equivalent
Dimension Lumber Joists	38 x 184 (2" x 8" nominal)
Column 1	2

Table 3.2.1.
Interior Post and Rail System Connection Details

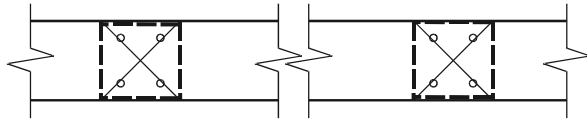
Connection Detail	Detail Number	Description
Top and/or Bottom Rail to Post	IA-1	Rail glued and screwed to post
Post to Floor	IB-1	Notched post glued and bolted to rim joist
Infill Picket	IC-1	Picket set into rails
	IC-2	Picket dowelled into rails
Stud Wall	ID-1	Wood stud and gypsum board
Column 1	2	3

Table 3.2.2.
Interior Cantilevered Picket System Connection Details

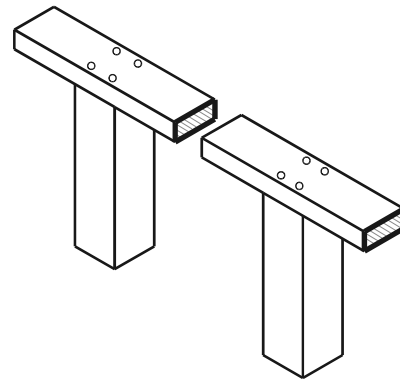
Connection Detail	Detail Number	Description
Picket to Floor	IE-1	Picket screwed to rim joist
Column 1	2	3

Table 3.2.3.
Interior Stair Guard Connection Details

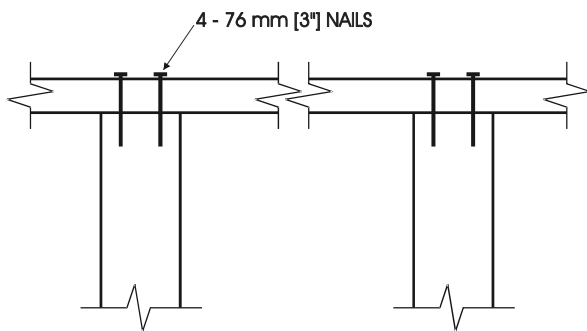
Connection Detail	Detail Number	Description
Rail to Post	IF-1	Top or bottom rail glued and screwed to post
Post to Floor and/or Picket Volute to Floor	IG-1	Notched post glued and screwed to stringer and riser
	IG-2	Post glued and screwed to stringer
	IG-3	Post glued and screwed to stringer and stud wall
	IG-4	Post and picket volute, oak or maple
	IG-5	Picket volute, 260 mm (10 ¹ / ₄ ") wide
	IG-6	Picket volute, 240 mm (9 ¹ / ₂ ") wide
Infill Picket	Detail IC-1 or IC-2 in Table 3.2.1., modified to suit a sloping installation, may be used.	
Cantilevered Picket	IH-1	Picket screwed to stair stringer
Column 1	2	3



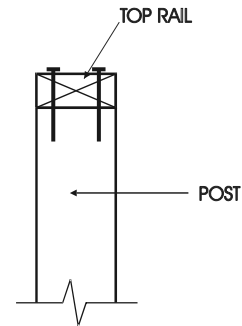
PLAN



AXONOMETRIC



FRONT ELEVATION



SIDE ELEVATION

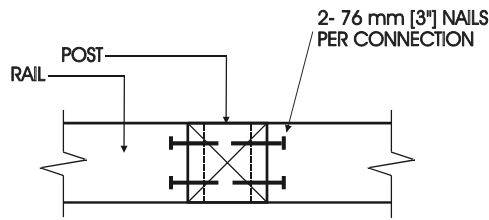
Detail EA-1

Exterior Connection: Top Rail Nailed to Post

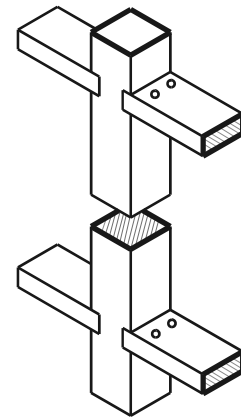
Notes:

1. The top rail must be continuous. Use Detail EA-5 at the end spans, where continuity ends.

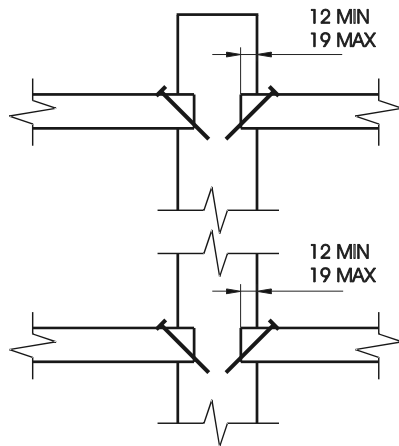
MAXIMUM SPAN OF RAIL BETWEEN POSTS	
Species	Maximum Span, m (ft-in)
Douglas Fir-Larch, Hem-Fir, Spruce-Pine-Fir	1.52 (5'-0")
Northern Species	1.52 (5'-0")
Column 1	2



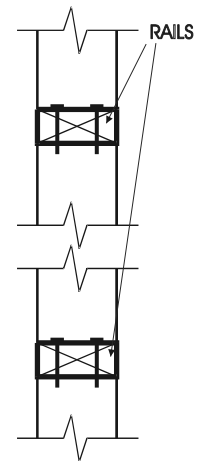
PLAN



AXONOMETRIC



FRONT ELEVATION



SIDE ELEVATION

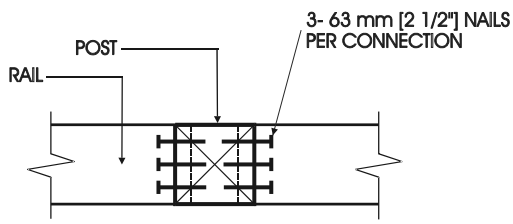
Detail EA-2

Exterior Connection: Top/Bottom Rail Skew Nailed to Post - 76 mm (3") Nails

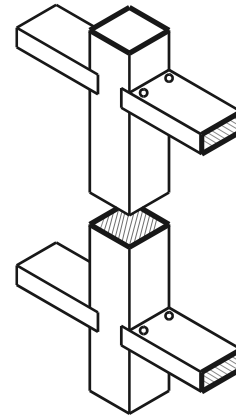
Notes:

1. The maximum span is more often governed by post spacing.
2. Provide support to bottom rail at intervals not more than 2.0 m (6'-7").
3. The bottom rail may be bevelled as detailed in Figure 2.1.2.
4. Dimensions shown are in mm unless otherwise specified.

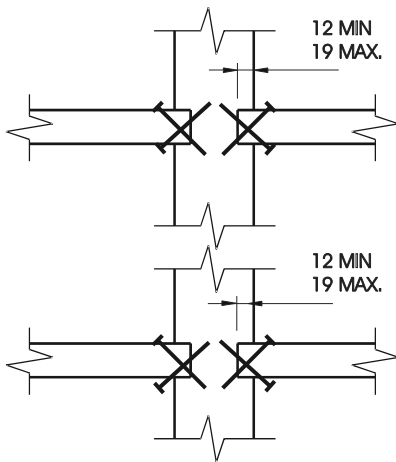
MAXIMUM SPAN OF RAIL BETWEEN POSTS	
Species	Maximum Span, m (ft-in)
Douglas Fir-Larch, Hem-Fir, Spruce-Pine-Fir	2.72 (8'-11")
Northern Species	2.18 (7'-2")
Column 1	2



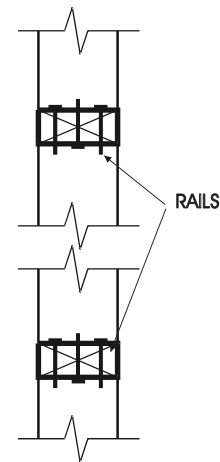
PLAN



AXONOMETRIC



FRONT ELEVATION



SIDE ELEVATION

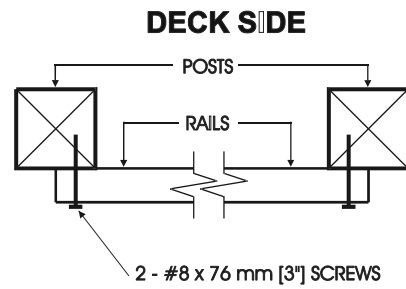
Detail EA-3

Exterior Connection: Top/Bottom Rail Skew Nailed to Post - 63 mm (2½") Nails

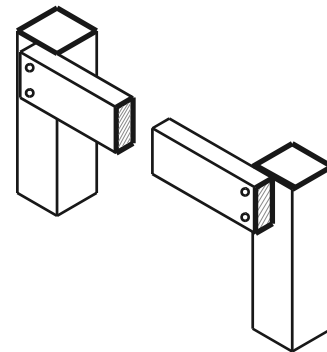
Notes:

1. Provide support to bottom rail at intervals not more than 2.0 m (6'-7").
2. The bottom rail may be bevelled as detailed in Figure 2.1.2.
3. Dimensions shown are in mm unless otherwise specified.

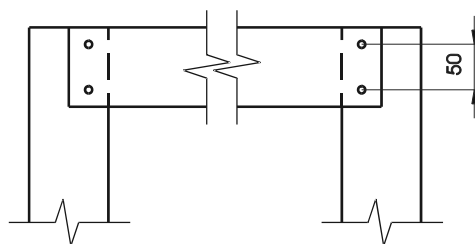
MAXIMUM SPAN OF RAIL BETWEEN POSTS	
Species	Maximum Span, m (ft-in)
Douglas Fir-Larch, Hem-Fir, Spruce-Pine-Fir	2.72 (8'-11")
Northern Species	2.18 (7'-2")
Column 1	2



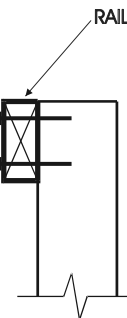
PLAN



AXONOMETRIC



FRONT ELEVATION



SIDE ELEVATION

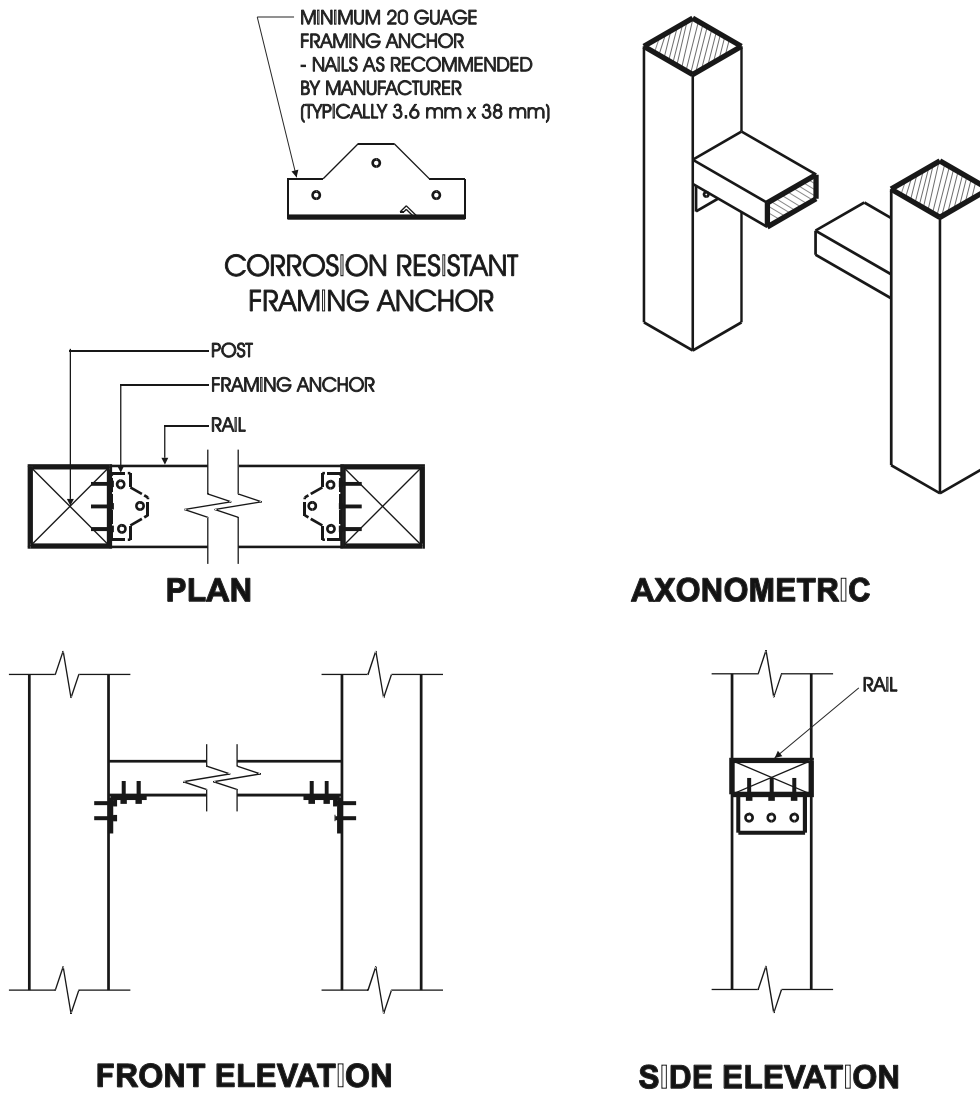
Detail EA-4

Exterior Connection: Top/Bottom Rail Face Nailed or Screwed to Post

Notes:

1. If the rails are located on the deck side of the posts, 76 mm (3") nails may be used in place of the screws.
2. Where the top rail is continuous, the top rail may be fastened to each post with 3 - #8 x 76 mm (3") screws.
3. Dimensions shown are in mm unless otherwise specified.

MAXIMUM SPAN OF RAIL BETWEEN POSTS	
Species	Maximum Span, m (ft-in)
Douglas Fir-Larch, Hem-Fir, Spruce-Pine-Fir	1.77 (5'-10")
Northern Species	1.41 (4'-8")
Column 1	2



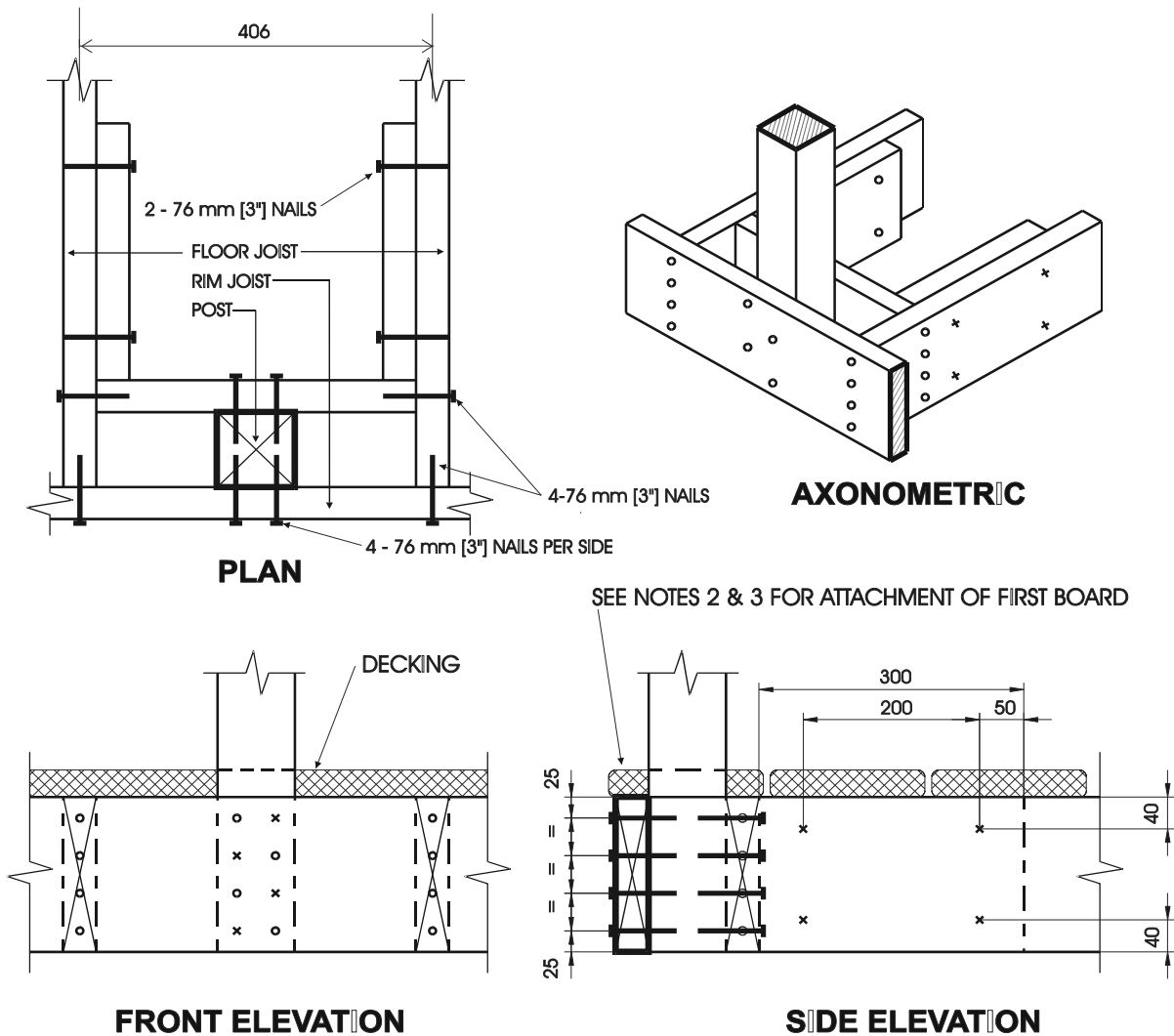
Detail EA-5

Exterior Connection: Top/Bottom Rail Fastened to Post with Framing Anchors

Notes:

1. Provide support to bottom rail at intervals not more than 2.0 m (6'-7").
2. The bottom rail may be beveled as detailed in Figure 2.1.2.
3. Dimensions shown are in mm unless otherwise specified.

MAXIMUM SPAN OF RAIL BETWEEN POSTS	
Species	Maximum Span, m (ft-in)
Douglas Fir-Larch, Hem-Fir, Spruce-Pine-Fir	2.72 (8'-11")
Northern Species	2.18 (7'-2")
Column 1	2



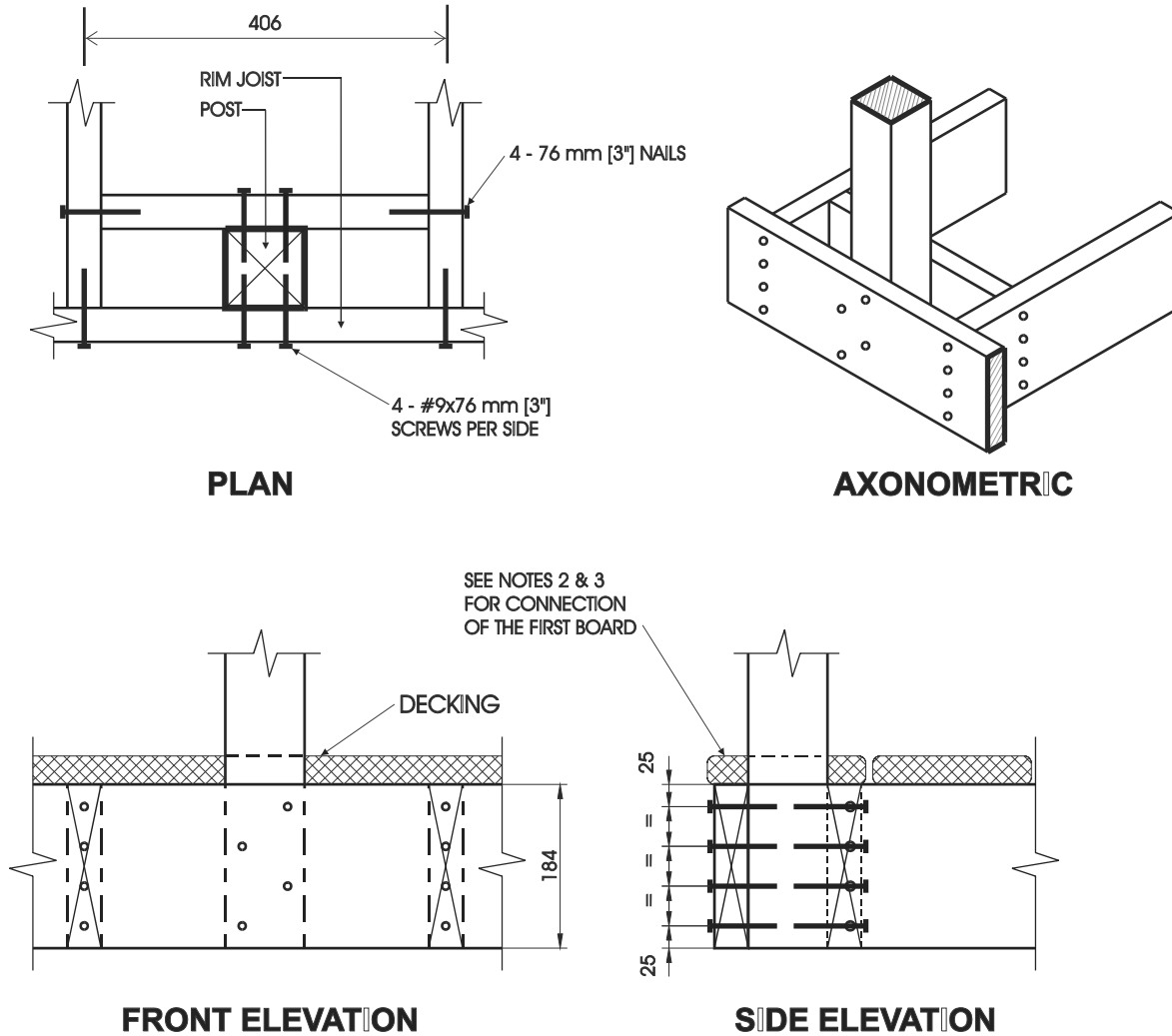
Detail EB-1

Exterior Connection: Post Nailed to Rim Joist

Notes:

1. Decking is omitted from the plan view and the axonometric view for clarity.
2. Fasten 25 mm x 140 mm (5/4" x 6" nominal) outer deck board to rim joist with 63 mm (2 1/2") nails at 300 mm (12").
3. Fasten 25 mm x 140 mm (5/4" x 6" nominal) outer deck board to floor joist with 1 - 63 mm (2 1/2") nail at each joist.
4. The post may be positioned anywhere between the joists.
5. Dimensions shown are in mm unless otherwise specified.

MAXIMUM SPAN OF RAIL BETWEEN POSTS	
Species	Maximum Span, m (ft-in)
Douglas Fir-Larch, Hem-Fir, Spruce-Pine-Fir	1.22 (4'-0")
Northern Species	1.20 (3'-11")
Column 1	2



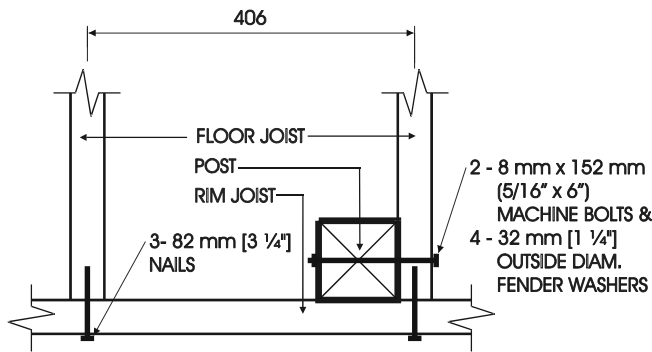
Detail EB-2

Exterior Connection: Post Screwed to Rim Joist

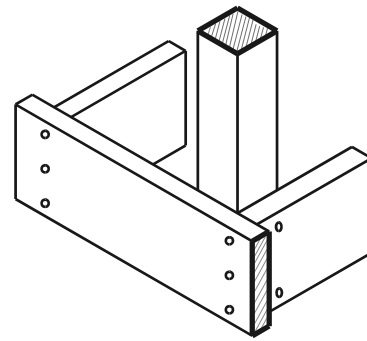
Notes:

1. Decking is omitted from the plan view and the axonometric view for clarity.
2. Fasten 25 mm x 140 mm (5/4" x 6" nominal) outer deck board to rim joist with 63 mm (2 1/2") nails at 300 mm (12").
3. Fasten 25 mm x 140 mm (5/4" x 6" nominal) outer deck board to floor joist with 1 - 63 mm (2 1/2") nail at each joist.
4. The post may be positioned anywhere between the joists.
5. #9 screws may be replaced by #8 screws if the maximum spacing between posts is not more than 1.20 m (3'-11").
6. Dimensions shown are in mm unless otherwise specified.

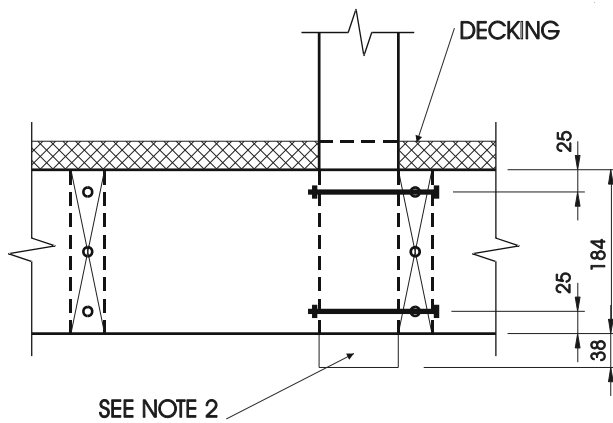
MAXIMUM SPAN OF RAIL BETWEEN POSTS	
Species	Maximum Span, m (ft-in)
Douglas Fir-Larch, Hem-Fir, Spruce-Pine-Fir	1.56 (5'-1")
Northern Species	1.20 (3'-11")
Column 1	2



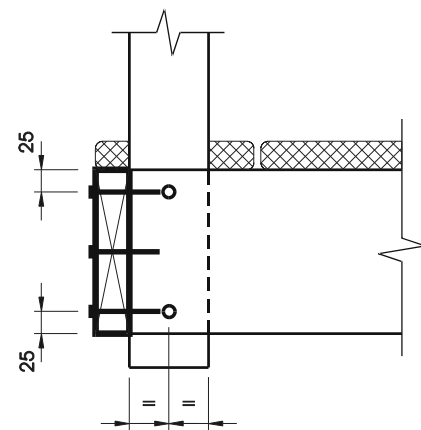
PLAN



AXONOMETRIC



FRONT ELEVATION



SIDE ELEVATION

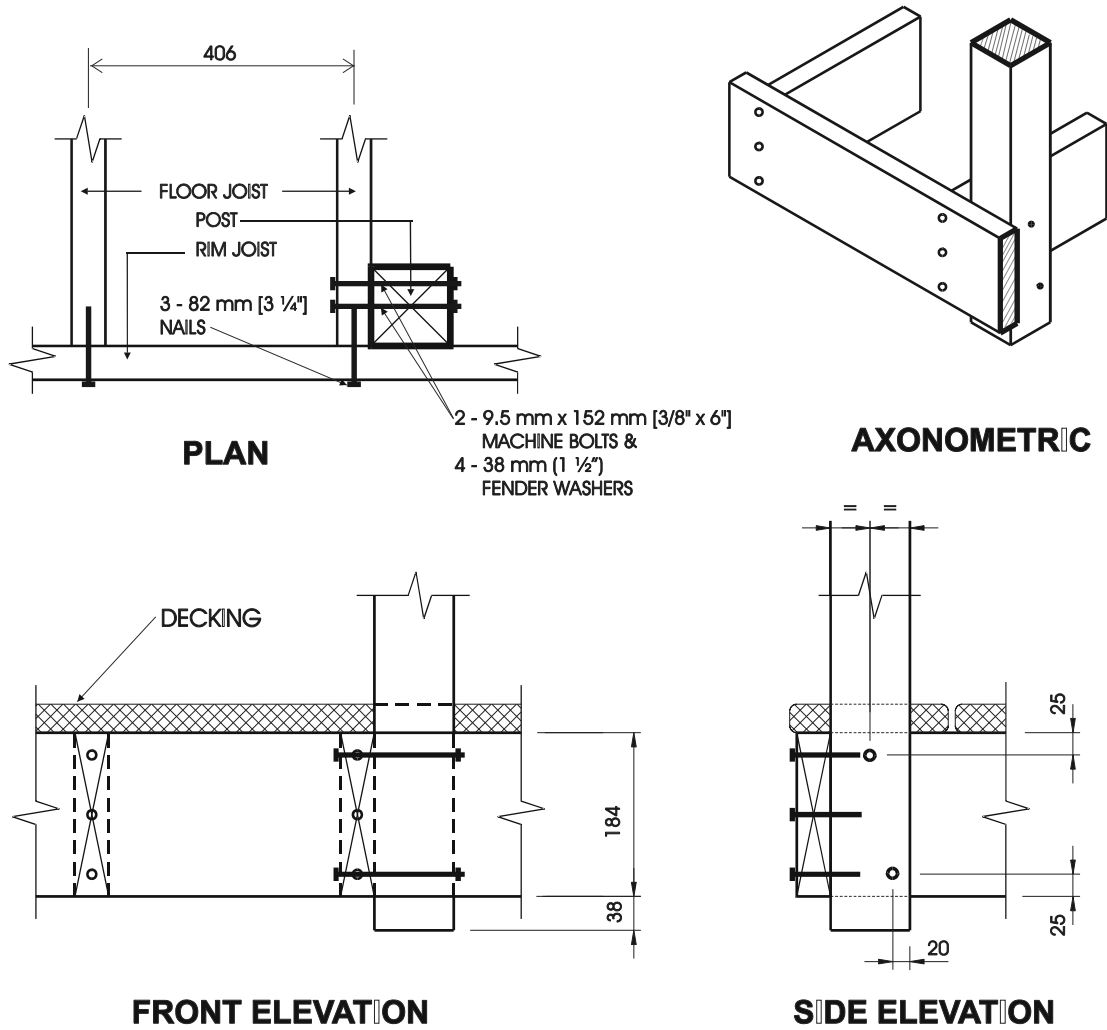
Detail EB-3

Exterior Connection: Post Bolted to Floor Joist - 8 mm (5/16") Bolts

Notes:

1. Decking is omitted from the plan view and the axonometric view for clarity.
2. 38 mm (1 1/2") post projection is not required where the maximum spacing between posts does not exceed 1.20 m (3'-11").
3. Joists may be spaced at 610 mm (24") o.c. or 406 mm (16") o.c.
4. Where floor joists are spaced at 610 mm (24") o.c., decking shall have a minimum thickness of 38 mm (1 1/2") and shall be fastened to the floor with 2 - 76 mm (3") nails.
5. Dimensions shown are in mm unless otherwise specified.

MAXIMUM SPACING BETWEEN POSTS	
Species	Maximum Span, m (ft-in)
Douglas Fir-Larch, Hem-Fir, Spruce-Pine-Fir	1.29 (4'-3")
Northern Species	1.20 (3'-11")
Column 1	2



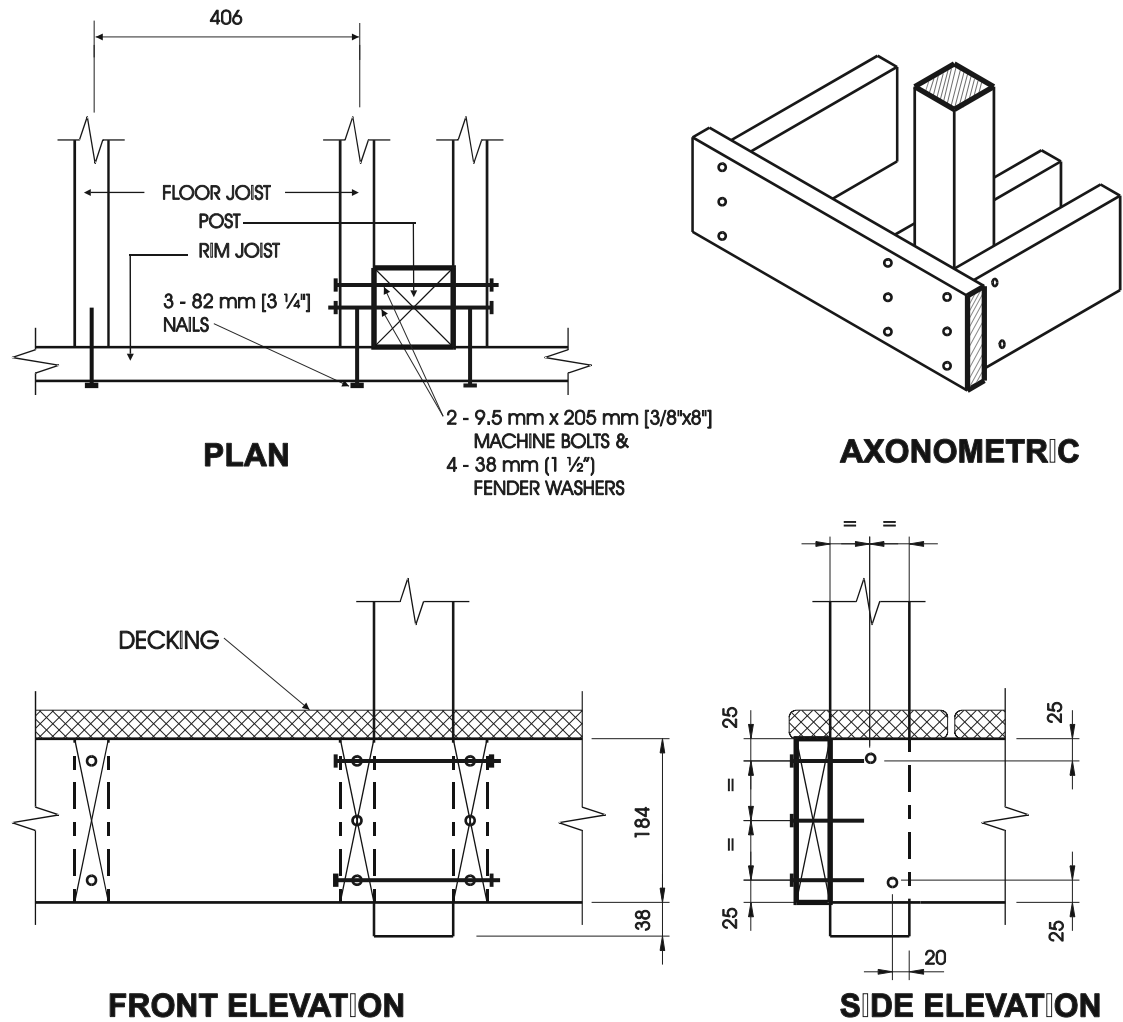
Detail EB-4

Exterior Connection: Post Bolted to Floor Joist - 9.5 mm (3/8") Bolts

Notes:

1. Decking is omitted from the plan view and the axonometric view for clarity.
2. 38 mm (1 1/2") post projection is not required where the maximum spacing between posts does not exceed 1.20 m (3'-11").
3. Joists may be spaced at 610 mm (24") o.c. or 406 mm (16") o.c.
4. Where floor joists are spaced at 610 mm (24") o.c., decking shall have a minimum thickness of 38 mm (1 1/2") and shall be fastened to the floor with 2 - 76 mm (3") nails.
5. Dimensions shown are in mm unless otherwise specified.

MAXIMUM SPACING BETWEEN POSTS	
Species	Maximum Span, m (ft-in)
Douglas Fir-Larch, Hem-Fir, Spruce-Pine-Fir	1.49 (4'-11")
Northern Species	1.20 (3'-11")
Column 1	2

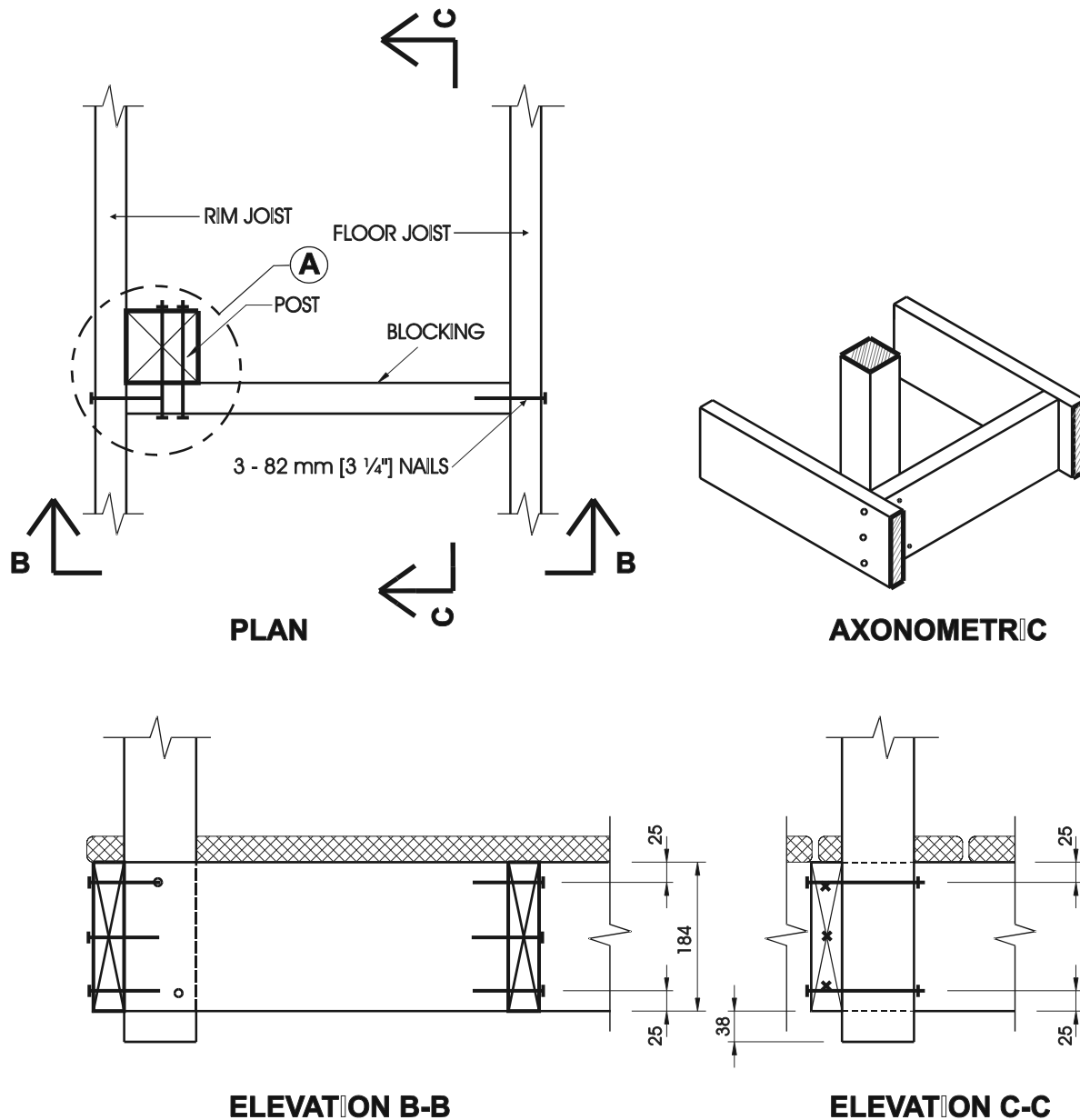


Detail EB-5
Exterior Connection: Post Bolted to 2 Floor Joists

Notes:

1. Decking is omitted from the plan view and the axonometric view for clarity.
2. 38 mm (1½") post projection is not required where the maximum spacing between posts does not exceed 1.20 m (3'-11").
3. Joists may be spaced at 610 mm (24") o.c. or 406 mm (16") o.c..
4. Where floor joists are spaced at 610 mm (24") o.c. decking shall have a minimum thickness of 38 mm (1½") and shall be fastened to the floor with 2 - 76 mm (3") nails.
5. Dimensions shown are in mm unless otherwise specified.

MAXIMUM SPACING BETWEEN POSTS	
Species	Maximum Span, m (ft-in)
Douglas Fir-Larch, Hem-Fir, Spruce-Pine-Fir	2.14 (7'-0")
Northern Species	1.20 (3'-11")
Column 1	2

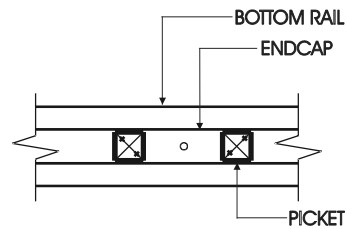


Detail EB-6

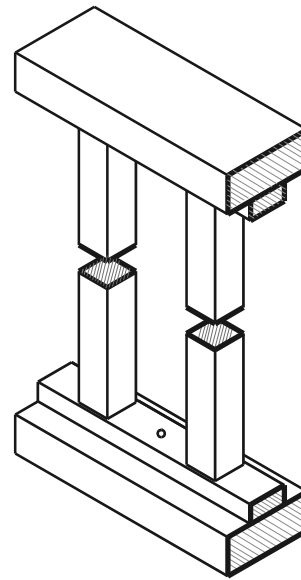
Exterior Connection: Post Fastened to Floor, Guard Parallel to Floor Joists

Notes:

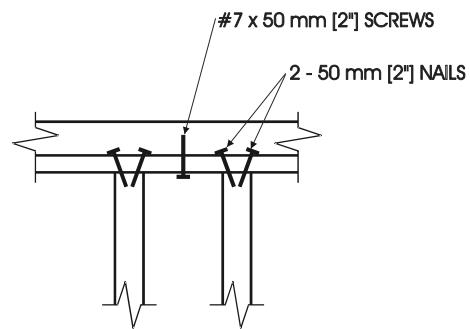
1. Use any of the connection details shown on Details EB-1 to EB-5 at location "A". Connection Detail EB-4 is shown in this detail, as an example.
2. Maximum spacing between posts is determined from connection detail used at location "A".
3. Decking is omitted from the plan view and the axonometric view for clarity.
4. Blocking shall be not less than 38 mm x 184 mm (2" x 8" nominal).
5. Dimensions shown are in mm unless otherwise specified.



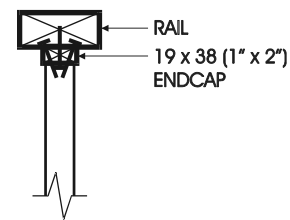
**PLAN
BOTTOM RAIL**



AXONOMETRIC



FRONT ELEVATION



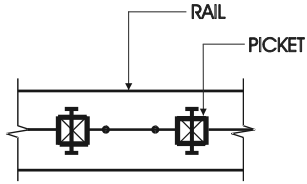
SIDE ELEVATION

Detail EC-1

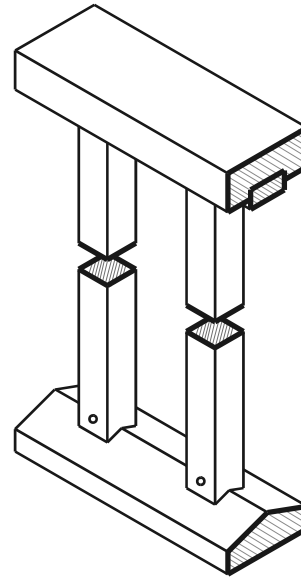
Exterior Connection: Infill Picket Nailed to Endcap - Endcap Screwed to Rail

Notes:

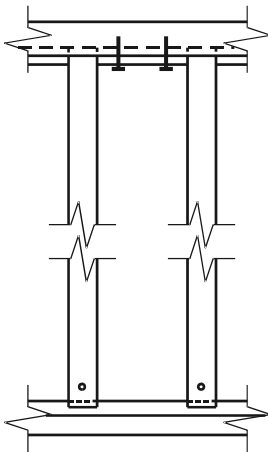
1. Fasten each end of each picket to endcaps with 2 - 50 mm (2") nails.
2. Fasten endcaps to rails with #7 x 50 mm (2") screws at 300 mm (12") o.c.
3. See Table 2.1.2. for minimum sizes of pickets.



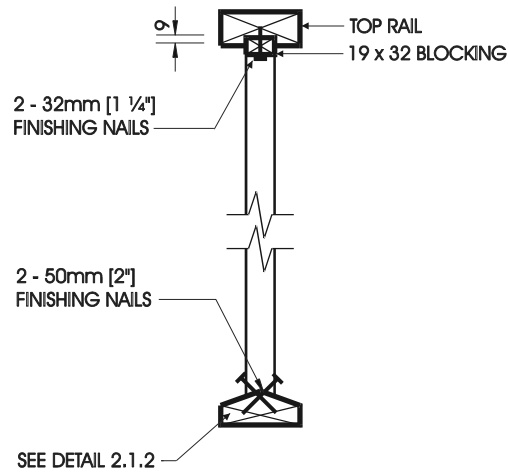
**PLAN
BOTTOM RAIL**



AXONOMETRIC



FRONT ELEVATION



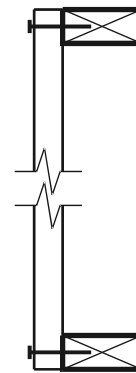
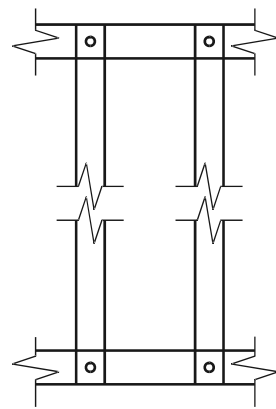
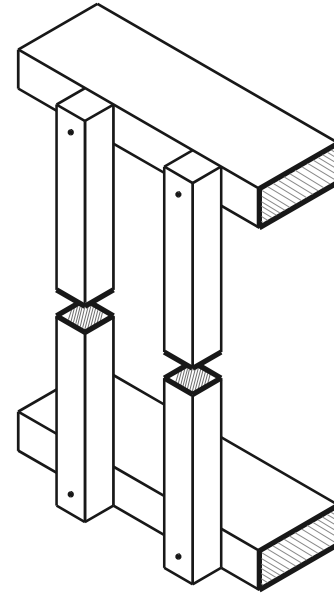
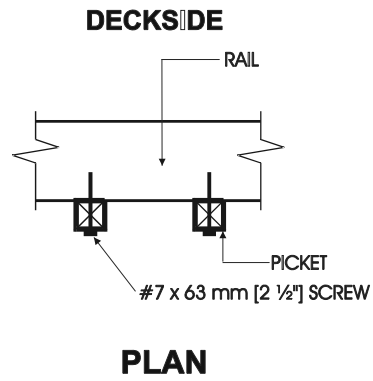
SIDE ELEVATION

Detail EC-2

Exterior Connection: Infill Picket Nailed to Rail

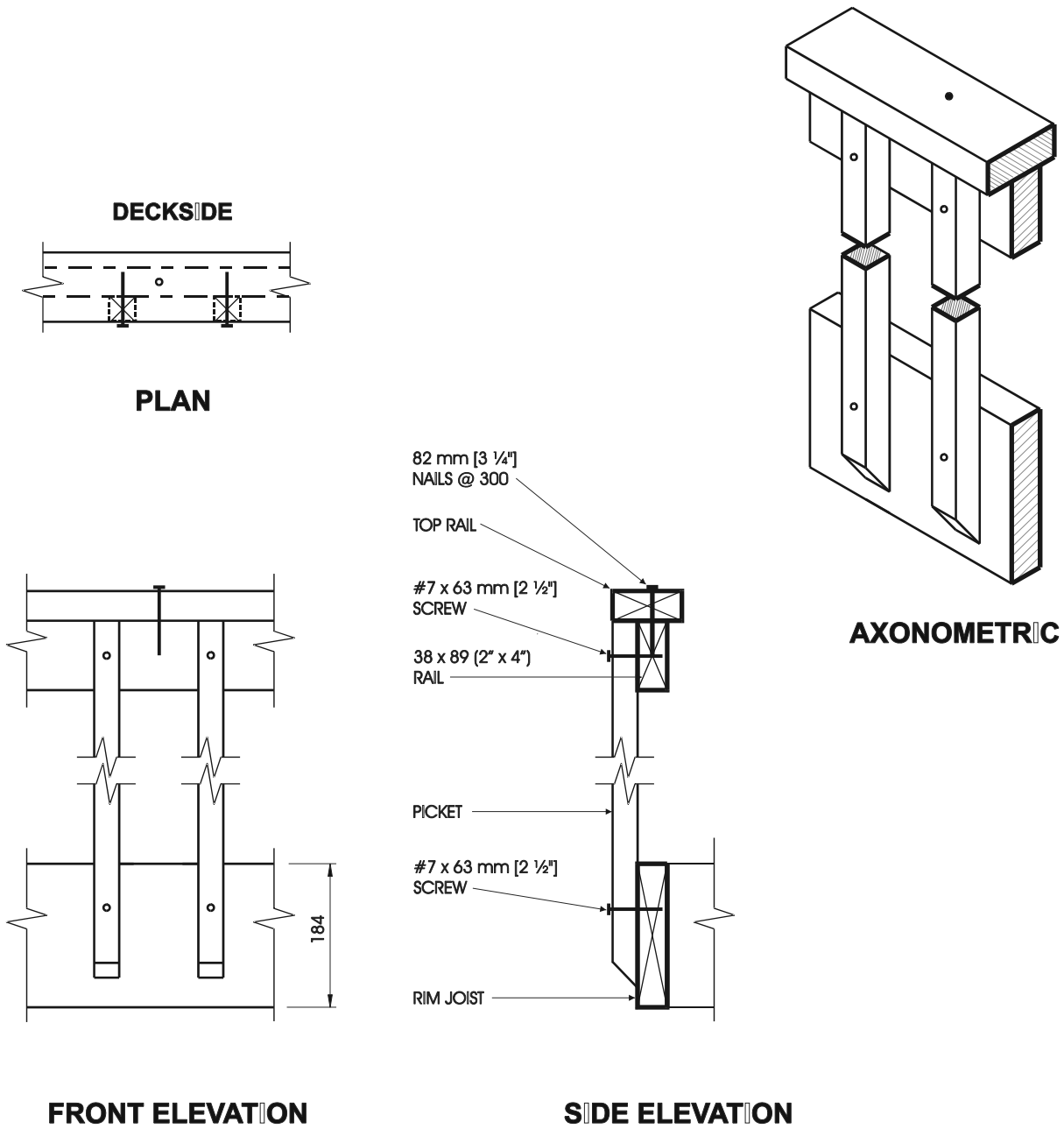
Notes:

1. See Table 2.1.2. for minimum sizes of pickets.
2. Dimensions shown are in mm unless otherwise specified.



Detail EC-3

Exterior Connection: Infill Picket Screwed to Rail

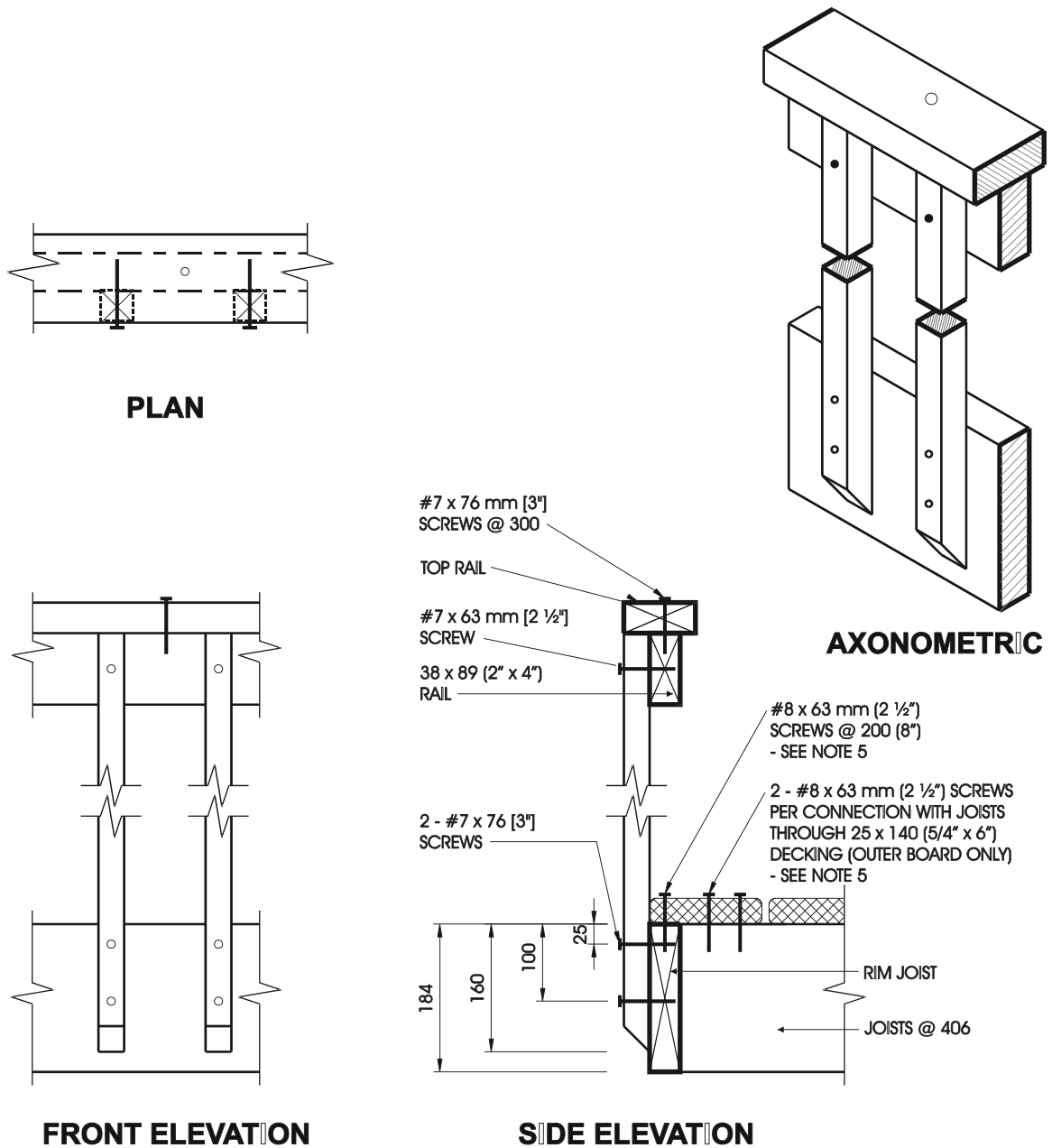


Detail EC-4

Exterior Connection: Infill Picket Screwed to Top Rail and Rim Joist

Note:

- 1. Dimensions shown are in mm unless otherwise specified.

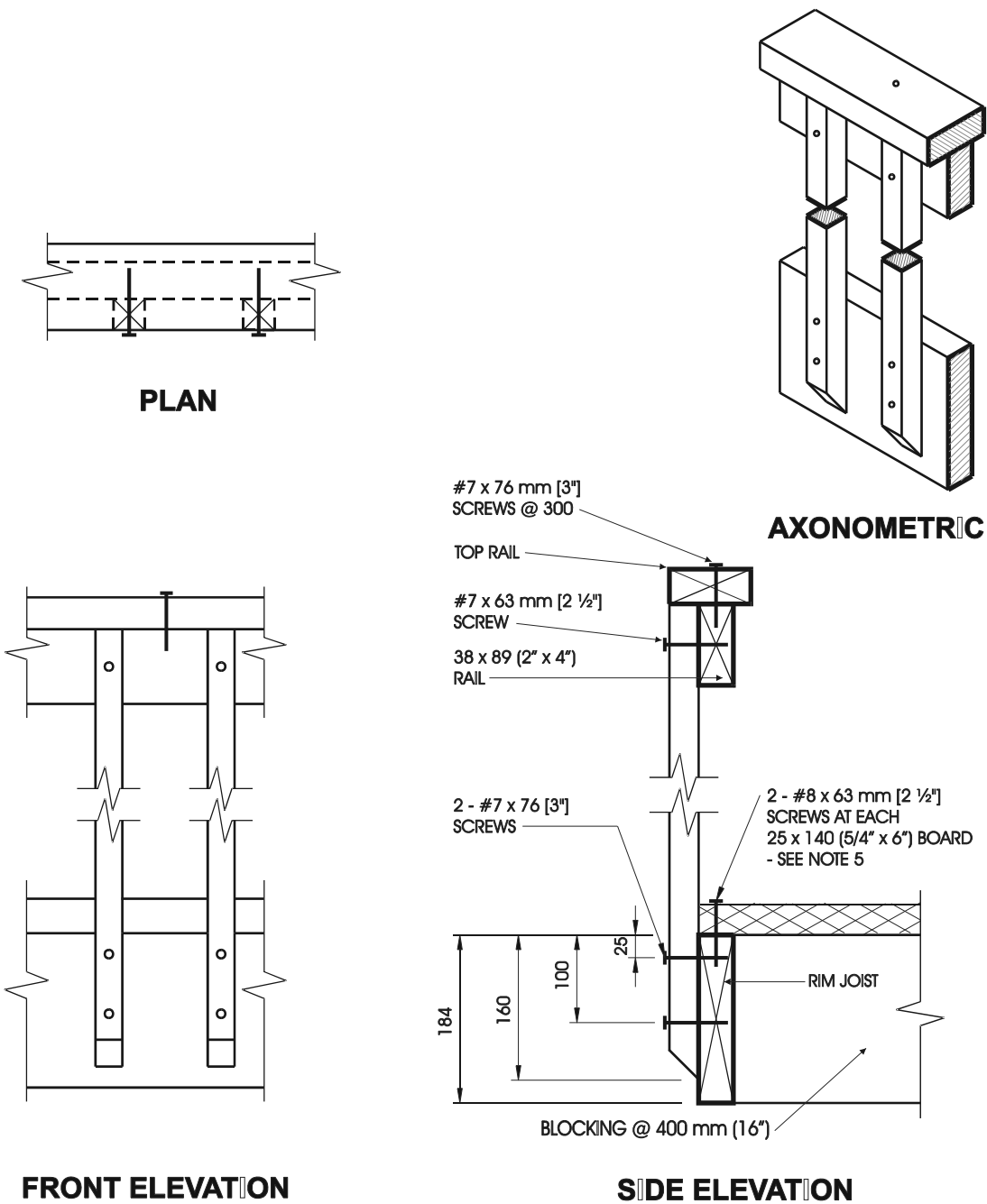


Detail ED-1

Exterior Connection: Cantilevered Picket Screwed to Rim Joist

Notes:

1. Provide a suitable post, return, or solid support at each end of the guard.
2. Wood for cantilevered pickets shall be Douglas Fir-Larch, Spruce-Pine-Fir, or Hem-Fir Species.
3. Fasten rim joist to each floor joist with 3 - 82 mm (3 1/4") nails.
4. Dimensions shown are in mm unless otherwise specified.
5. The outer deck board shall not be less than 140 mm (6" nominal) wide. Where 38 mm (2" nominal) thick boards are used, the length of the wood screws shall be not less than 76 mm (3").

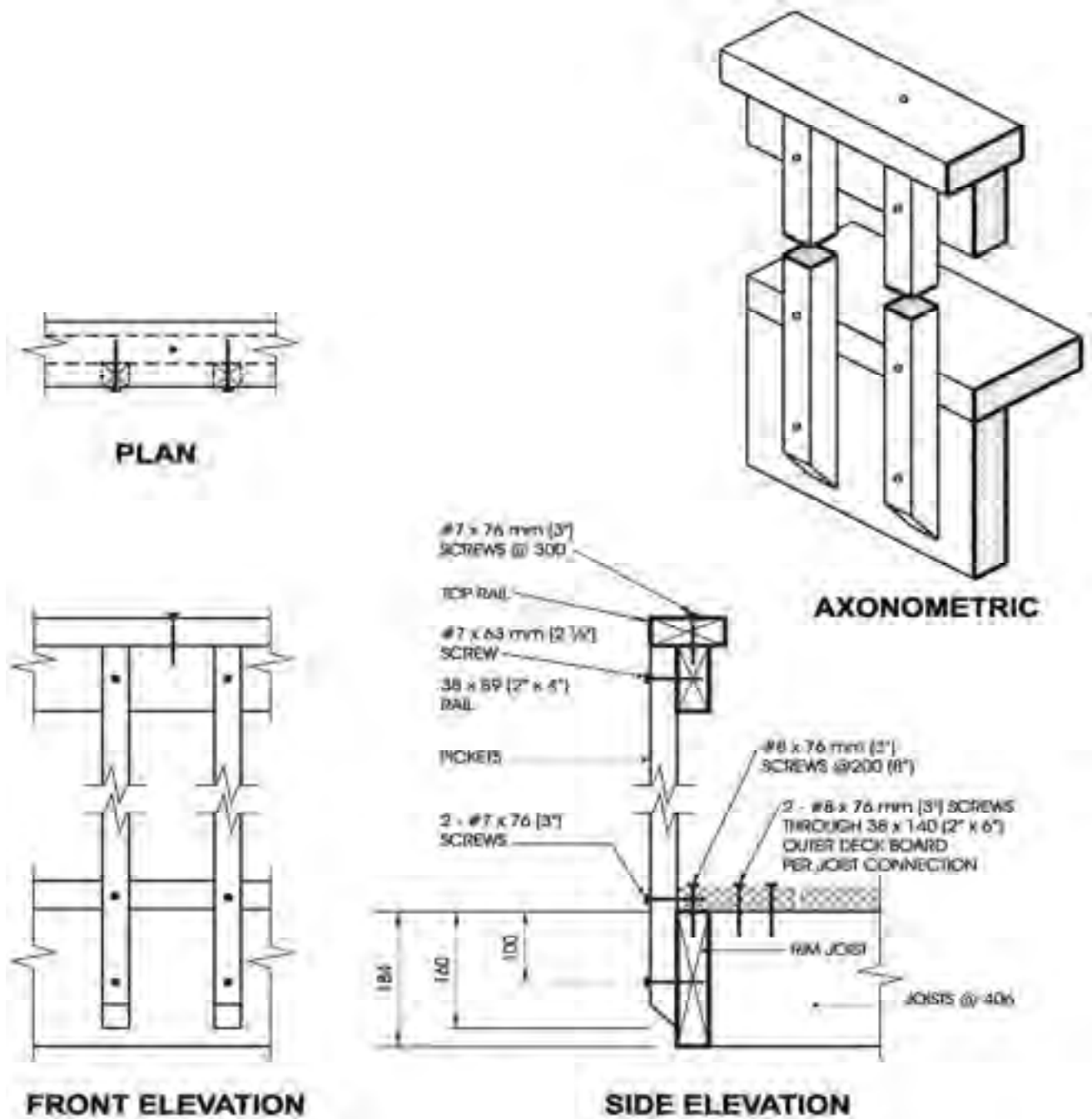


Detail ED-2

Exterior Connection: Cantilevered Picket Screwed to Rim Joist,
Guard Parallel to Floor Joists

Notes:

1. Provide a suitable post, return, or solid support at each end of the guard.
2. Wood for cantilevered pickets shall be Douglas Fir-Larch, Spruce-Pine-Fir, or Hem-Fir Species.
3. Fasten rim joist to blocking with 3 - 82 mm (3 1/4") nails.
4. Dimensions shown are in mm unless otherwise specified.
5. Where 38 mm (2" nominal) thick boards are used, the length of the wood screws shall be not less than 76 mm (3").

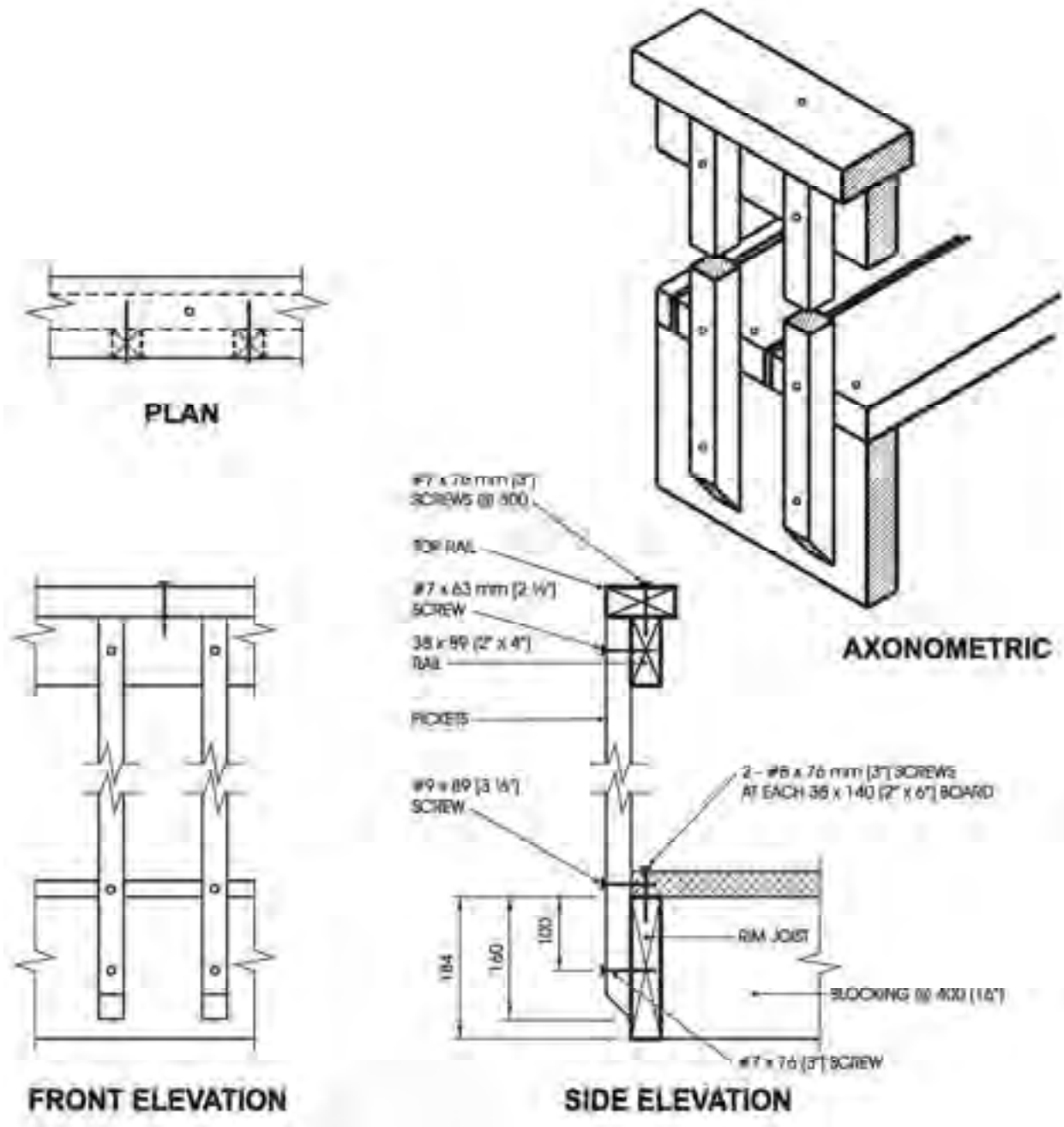


Detail ED-3

Exterior Connection: Cantilevered Picket Screwed to Rim Joist and Deck

Notes:

1. Provide a suitable post, return, or solid support at each end of the guard.
2. Wood for cantilevered pickets shall be Northern Species.
3. Fasten rim joist to each floor joist with 3- 82 mm (3 1/4") nails.
4. Dimensions shown are in mm unless otherwise specified.

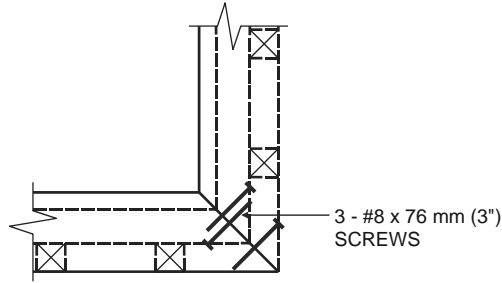


Detail ED-4

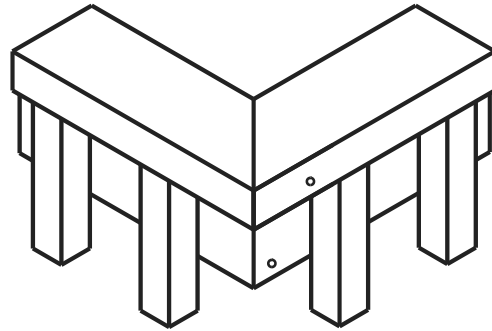
Exterior Connection: Cantilevered Picket Screwed to Rim Joist and Deck,
Guard Parallel to Floor Joists

Notes:

1. Provide a suitable post, return, or solid support at each end of the guard.
2. Wood for cantilevered pickets shall be Northern Species.
3. Fasten rim joist to blocking with 3 - 82 mm (3 1/4") nails.
4. Dimensions shown are in mm unless otherwise specified.

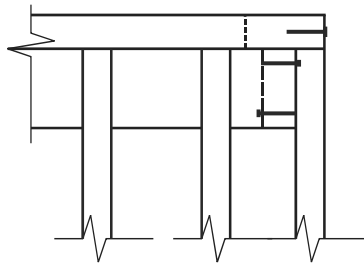


PLAN TOP RAIL

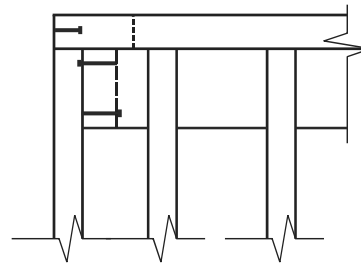


AXONOMETRIC

ONE FASTENER IN HORIZONTALLY ORIENTATED PORTION OF TOP RAIL AND TWO IN VERTICALLY ORIENTATED PORTION.



FRONT TOP RAIL



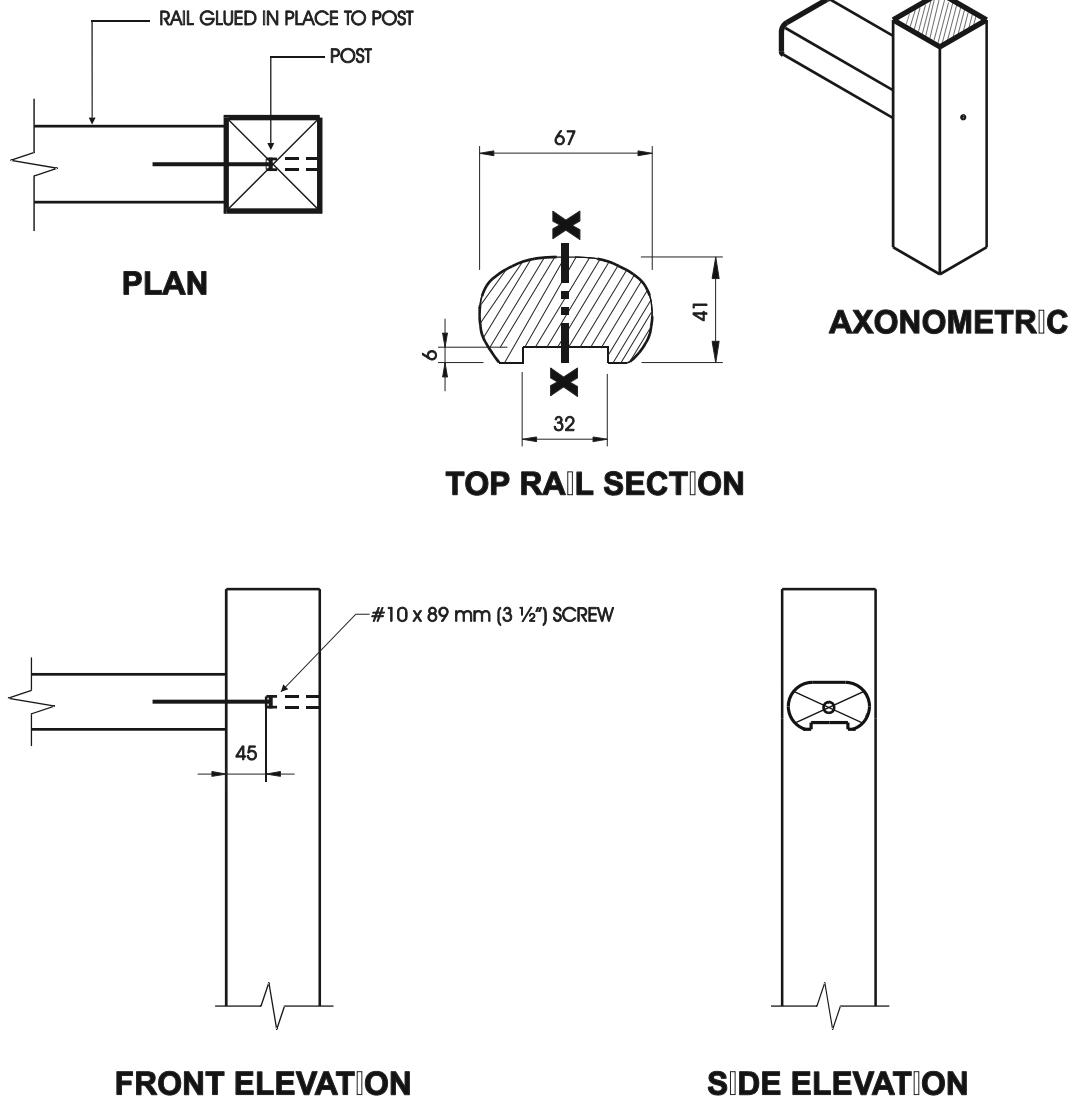
SIDE TOP RAIL

Detail ED-5

Exterior Connection: Corner Joint

Notes:

1. Screws fastening pickets are omitted for clarity.
2. Provide a minimum of 10 pickets beyond the return if end restraint of the guard is provided by this return detail only.



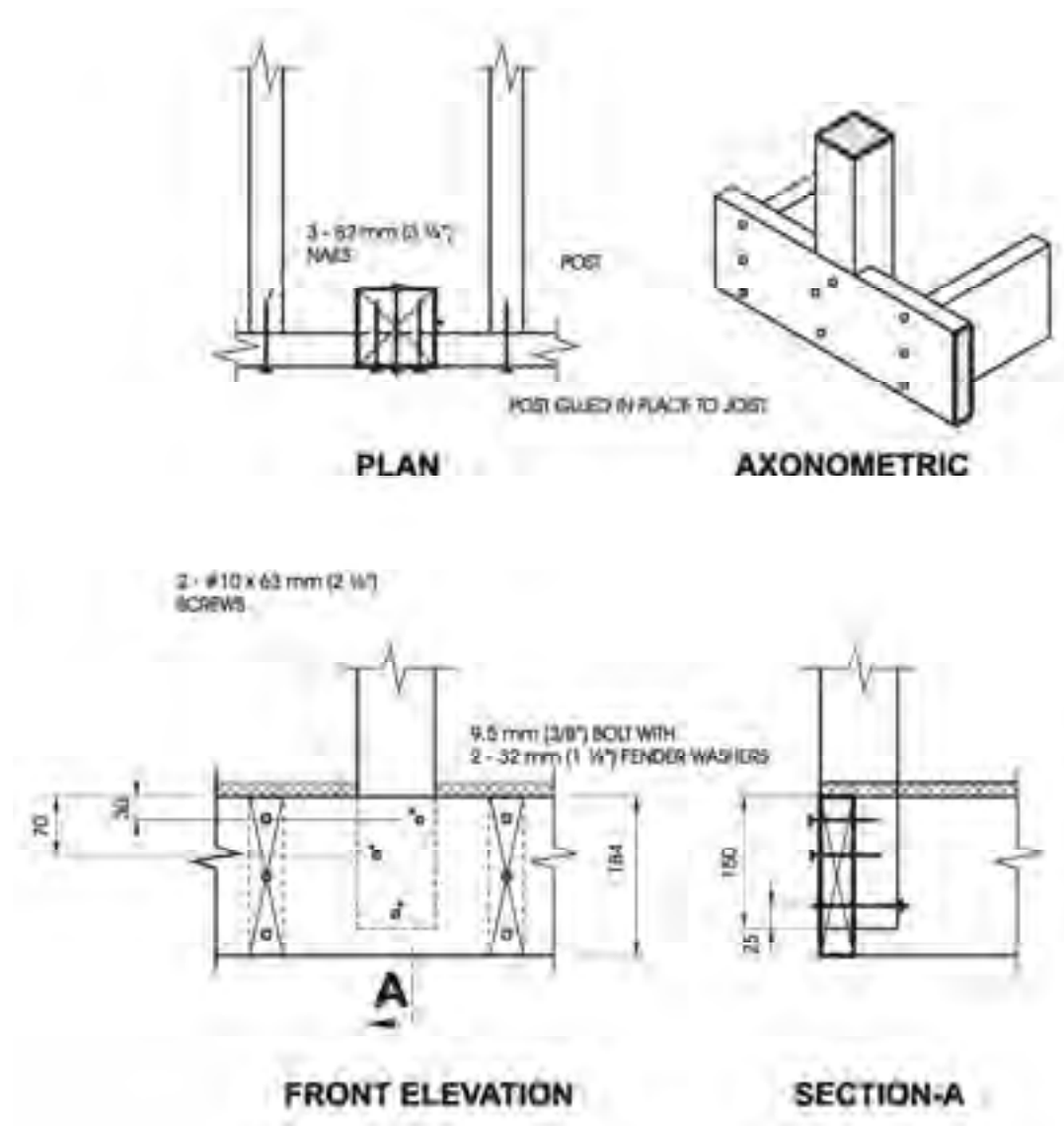
Detail IA-1

Interior Connection: Rail Glued and Screwed to Post

Notes:

1. Other top rail systems may be used provided the section modulus is not less than 24,000 mm³, measured about the x-x axis.
2. Pickets omitted on drawing for clarity.
3. Connection details for fastening of pickets to rails are shown on Details IC-1 and IC-2.
4. Dimensions shown are in mm unless otherwise specified.

MAXIMUM SPAN OF RAIL BETWEEN POSTS	
Species	Maximum Span, m (ft-in)
Oak, Maple	3.30 (10'-10")
Column 1	2



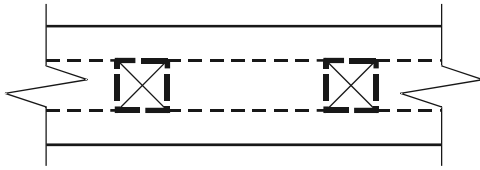
Detail IB-1

Interior Connection: Notched Post Glued and Bolted to Rim Joist

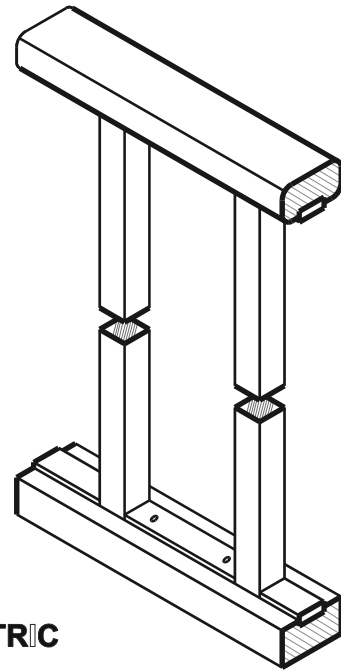
Notes:

1. Minimum dimension of post is 82 mm x 82 mm (3 1/4" x 3 1/4").
2. Notch post 38 mm x 152 mm (1 1/2" x 6") at rim joist.
3. Dimensions shown are in mm unless otherwise specified.

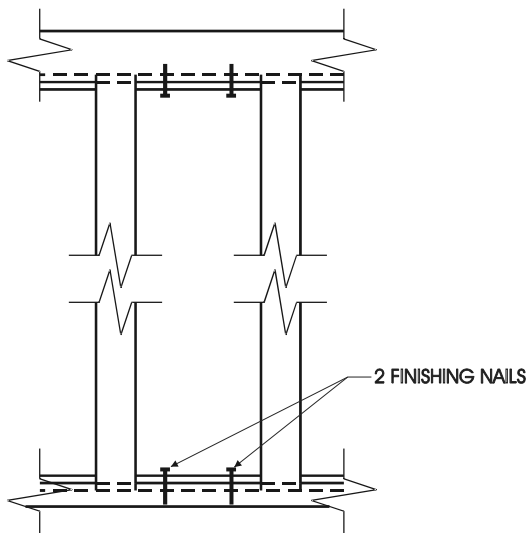
MAXIMUM SPACING BETWEEN POSTS	
Post Species	Maximum Span, m (ft-in)
Oak, Maple, Yellow Poplar, Hemlock, White Pine	3.30 (10'-10")
Column 1	2



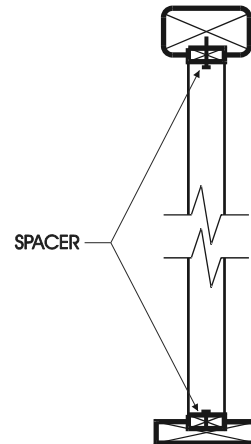
PLAN



AXONOMETRIC



FRONT ELEVATION



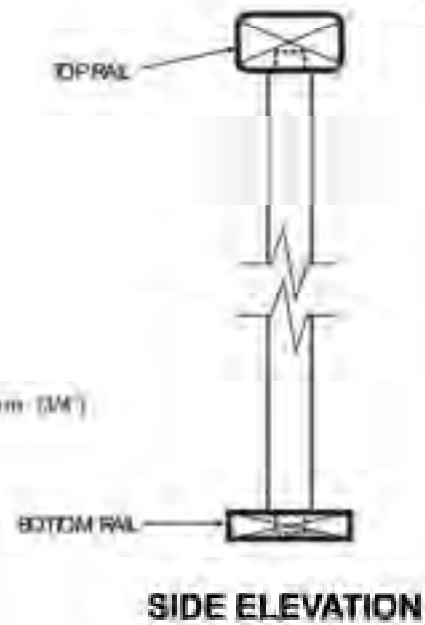
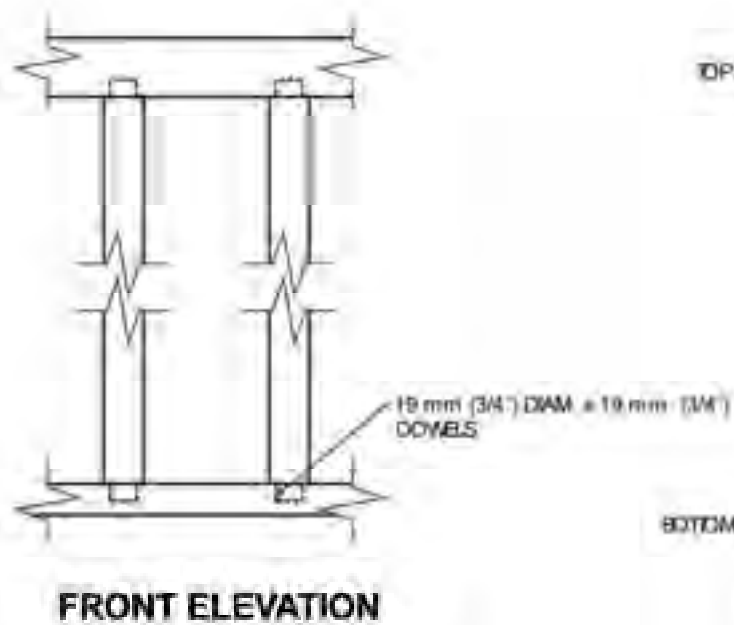
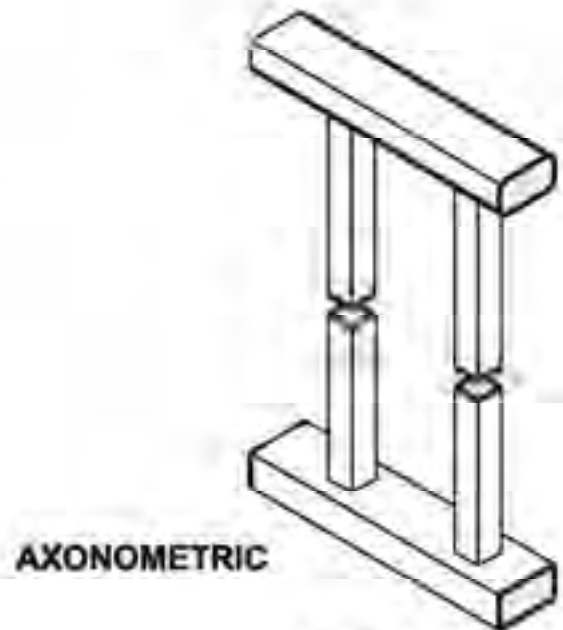
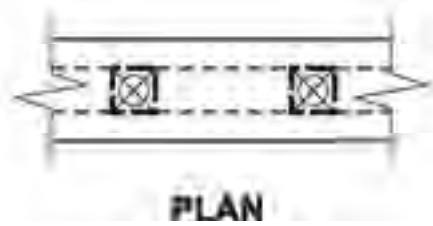
SIDE ELEVATION

Detail IC-1

Interior Connection: Infill Picket Set into Rails

Notes:

- 1. See Table 3.1.2. for minimum sizes of pickets.
- 2. For top and bottom rail provide 6 mm (1/4") deep rabbet.

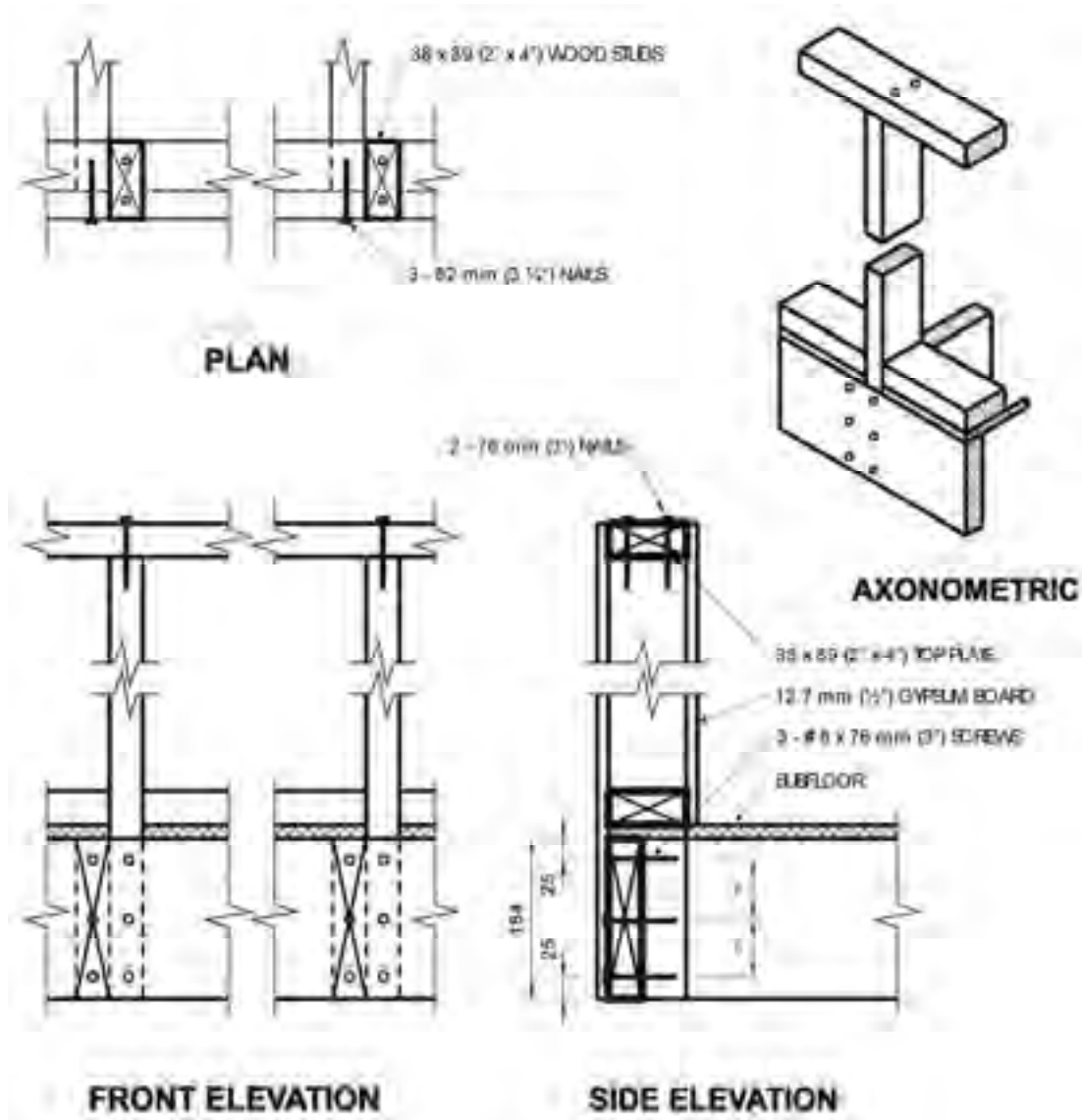


Detail IC-2

Interior Connection: Infill Picket Dowelled into Rails

Notes:

1. See Table 3.1.2 for minimum sizes of pickets.
2. Pickets dowelled 19 mm (3/4") deep into rails with 19 mm (3/4") diameter dowels.

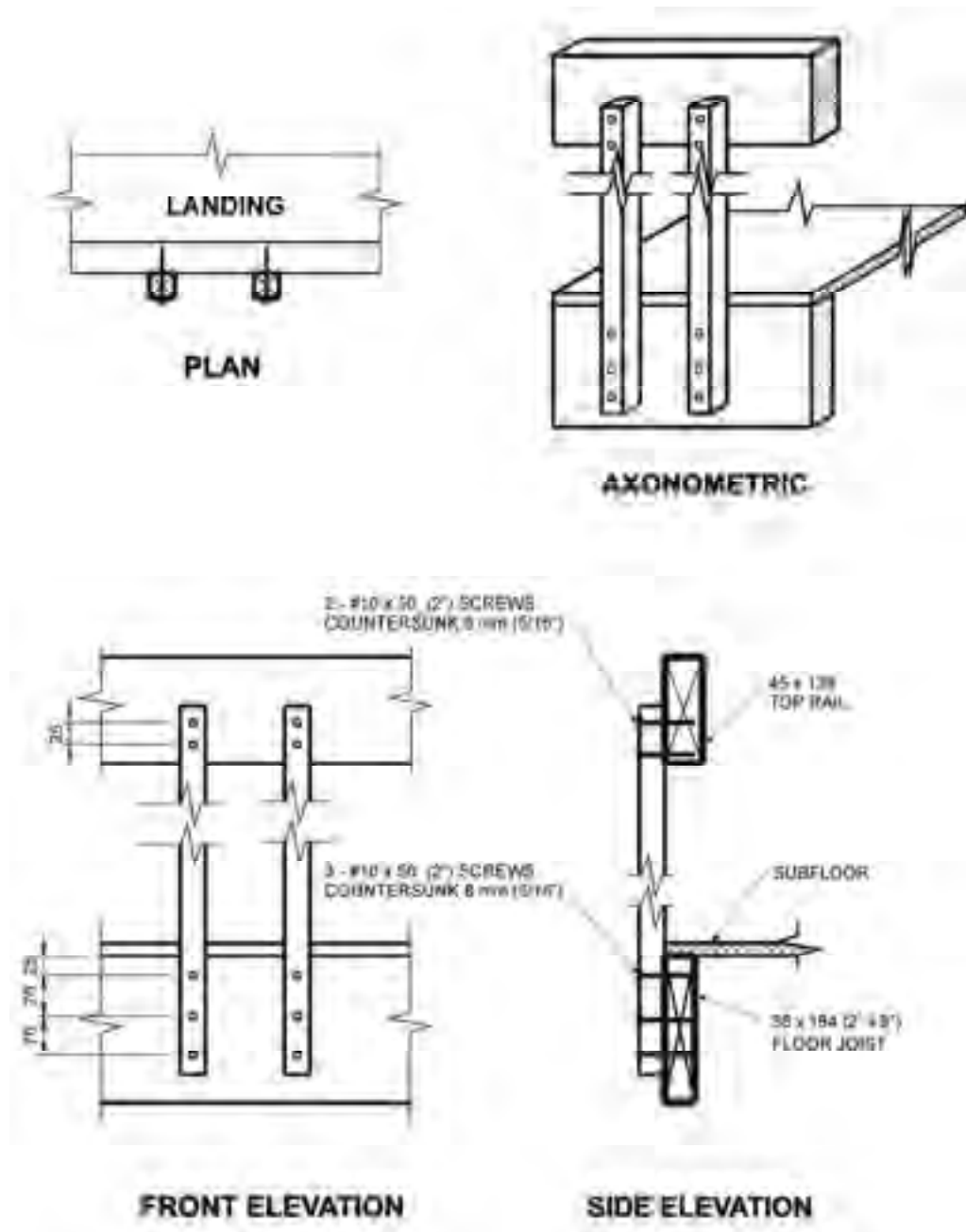


Detail ID-1
Interior Connection: Wood Stud and Gypsum Board Guard

Notes:

1. Fasten plywood subfloor to joists with 50 mm (2") nails at 150 mm (6") oc along edges and at 300 mm (12") oc along intermediate supports.
2. Gypsum board omitted on plan, front elevation, and axonometric for clarity.
3. Dimensions shown are in mm unless otherwise specified.
4. Provide a suitable post, return, or solid support at each end of the guard.

MAXIMUM SPACING BETWEEN WOOD STUDS	
Stud Species	Maximum Spacing, mm (in)
Douglas Fir-Larch, Hem-Fir, Spruce-Pine-Fir, Northern Species	406 (16")
Column 1	2

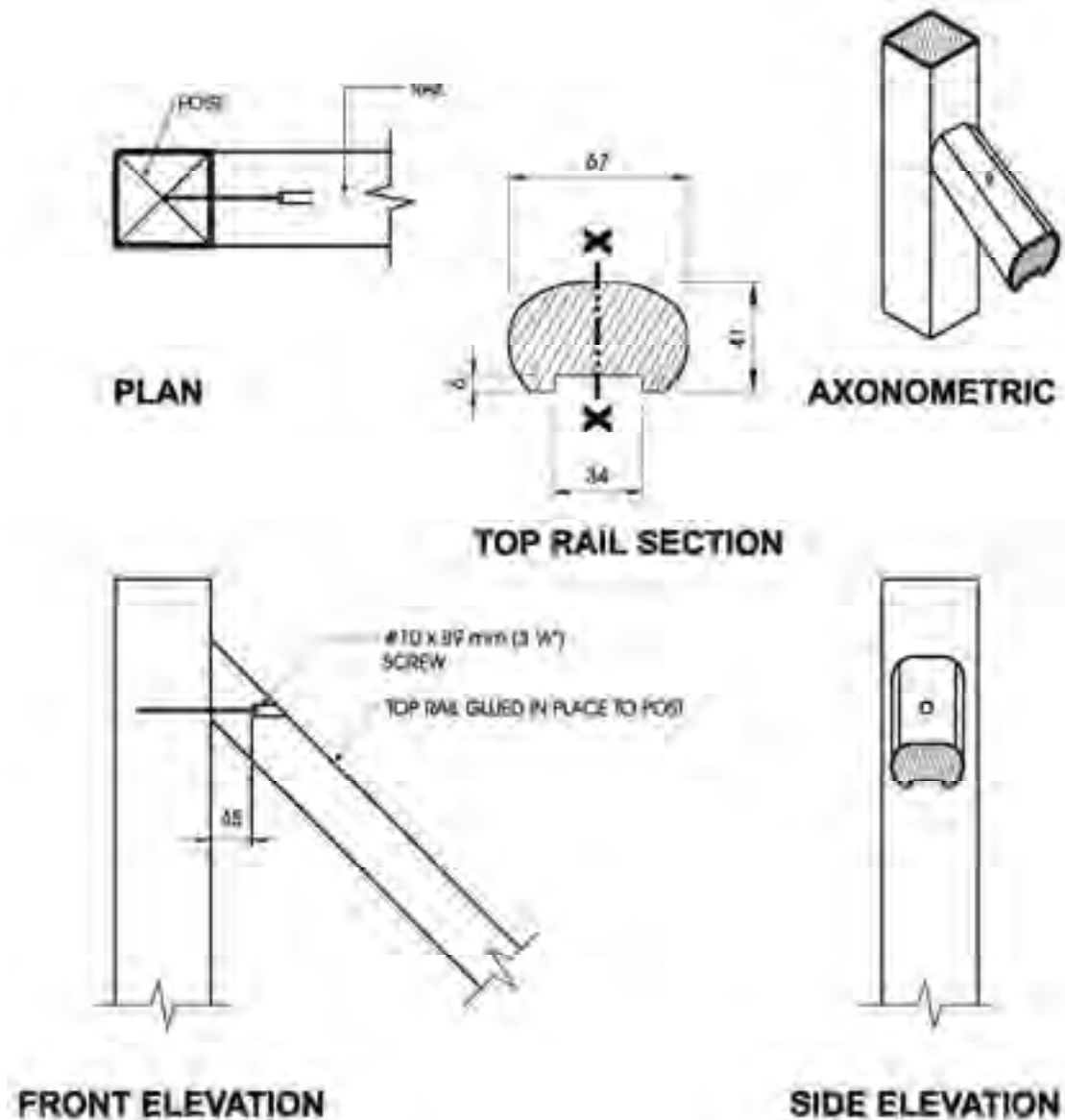


Detail IE-1

Interior Connection: Cantilevered Picket Screwed to Rim Joist

Notes:

1. Provide a suitable post, return, or solid support at each end of the guard.
2. See Table 3.1.2. for minimum sizes of pickets.
3. Dimensions shown are in mm unless otherwise specified.
4. Rim joist and top rail of oak or maple.



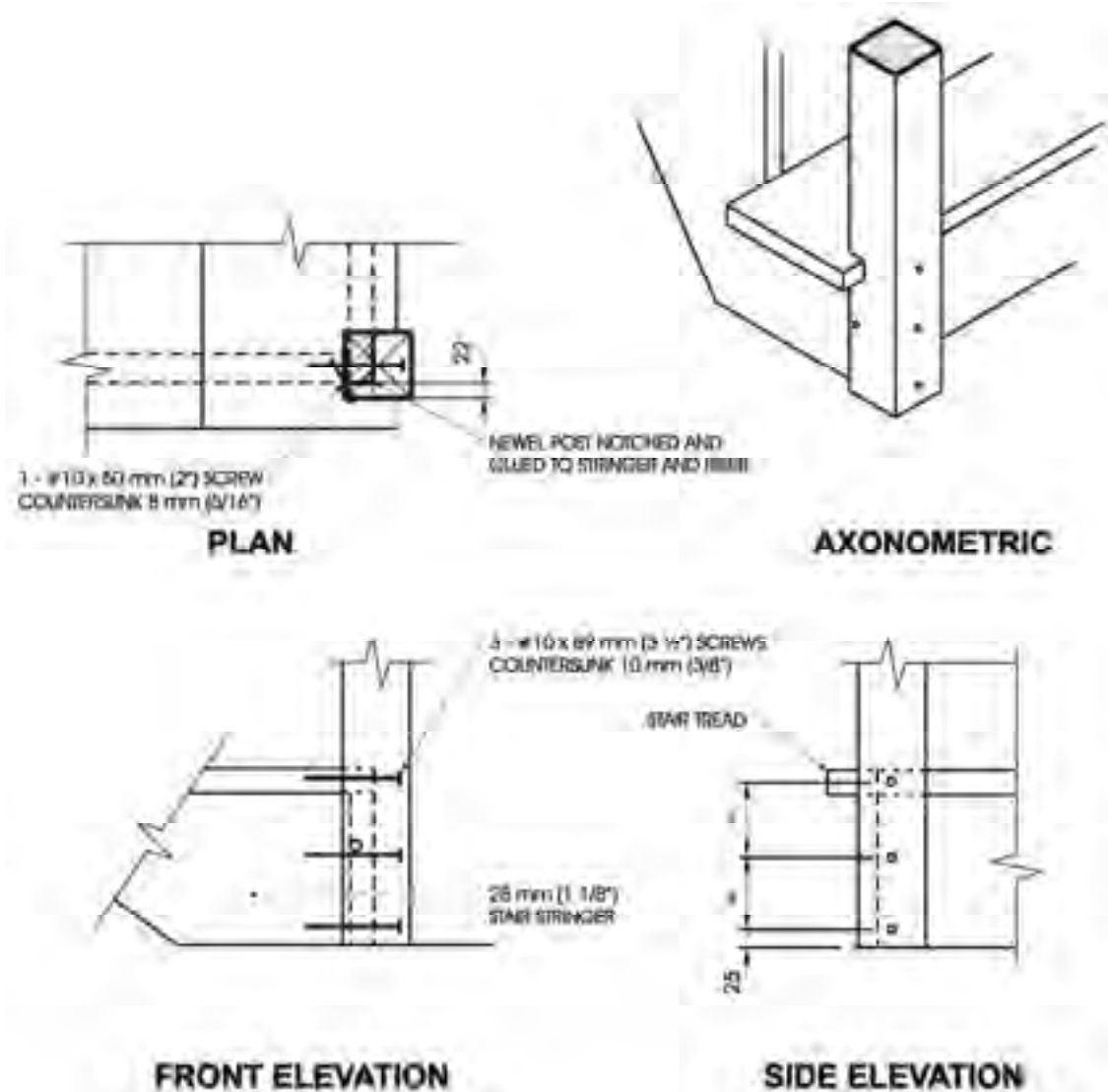
Detail IF-1

Interior Stair Guard Connection: Top/Bottom Rail Glued and Screwed to Post

Notes:

1. Maximum permitted span is based on a slope between 35° and 45° from the horizontal.
2. Minimum section modulus of top rail shall be 24,000 mm³, measured about the x-x axis.
3. Pickets omitted on drawing, for clarity.
4. Detail IC-1 or Detail IC-2, modified to suit a sloping application may be used for picket to rail connections.

MAXIMUM SPAN OF RAIL, MEASURED ALONG THE SLOPE	
Rail Species	Maximum Span, m (ft-in)
Oak, Maple	4.30 (14'-1")
Column 1	2



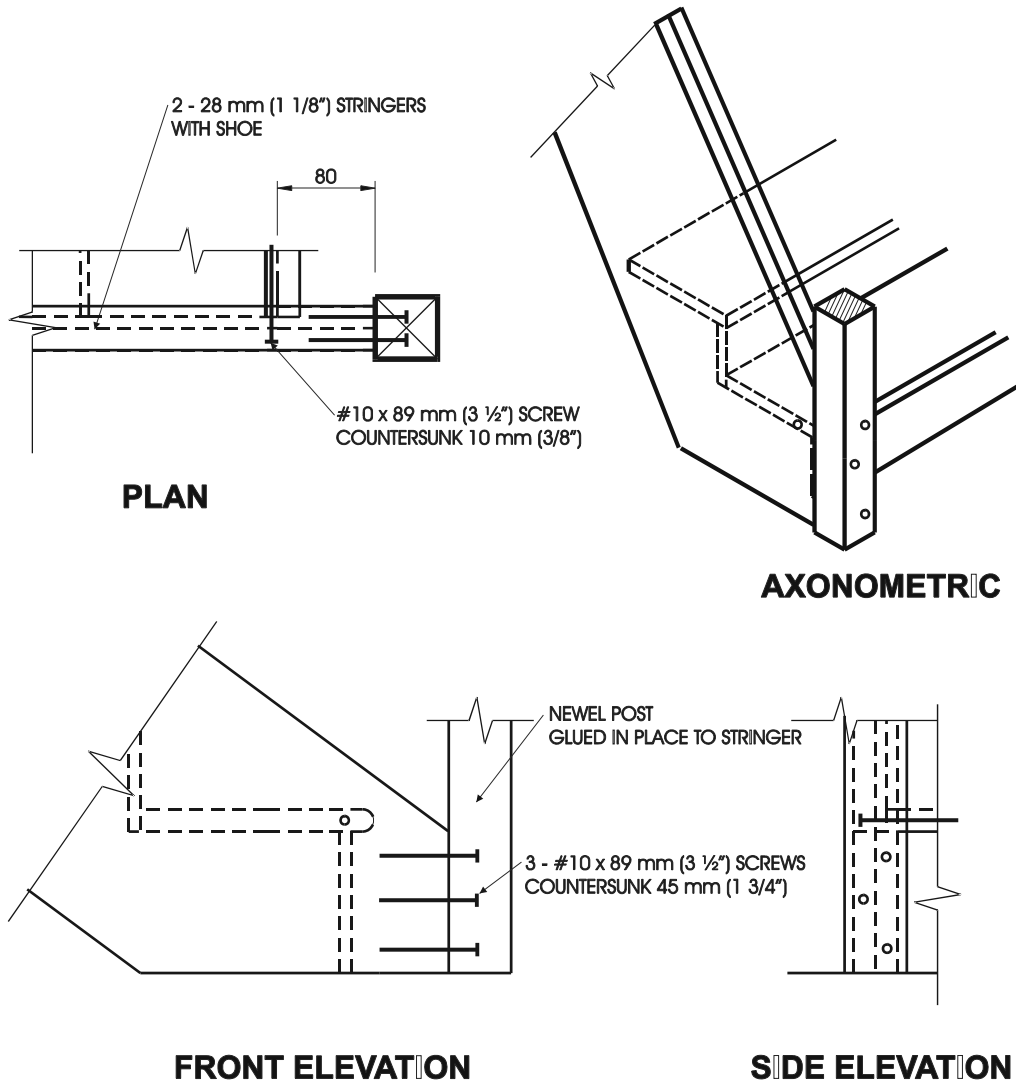
Detail IG-1

Interior Stair Guard Connection: Notched Post Glued & Screwed to Stringer & Riser

Notes:

1. Stringer shall be oak or maple.
2. Notch post 38 mm x 60 mm (1 1/2" x 2 3/8") to fit over stair stringer.
3. Only the first riser and tread are shown, for clarity.
4. Minimum thickness of riser shall be 12 mm (1/2").
5. Detail IC-1 or Detail IC-2, modified to suit a sloping application may be used for picket to rail connections.
6. Dimensions shown are in mm unless otherwise specified.

MAXIMUM SPACING BETWEEN POSTS	
Post Species	Maximum Span, m (ft-in)
Oak, Maple, Yellow Poplar, Hemlock, White Pine	3.30 (10'-10")
Column 1	2



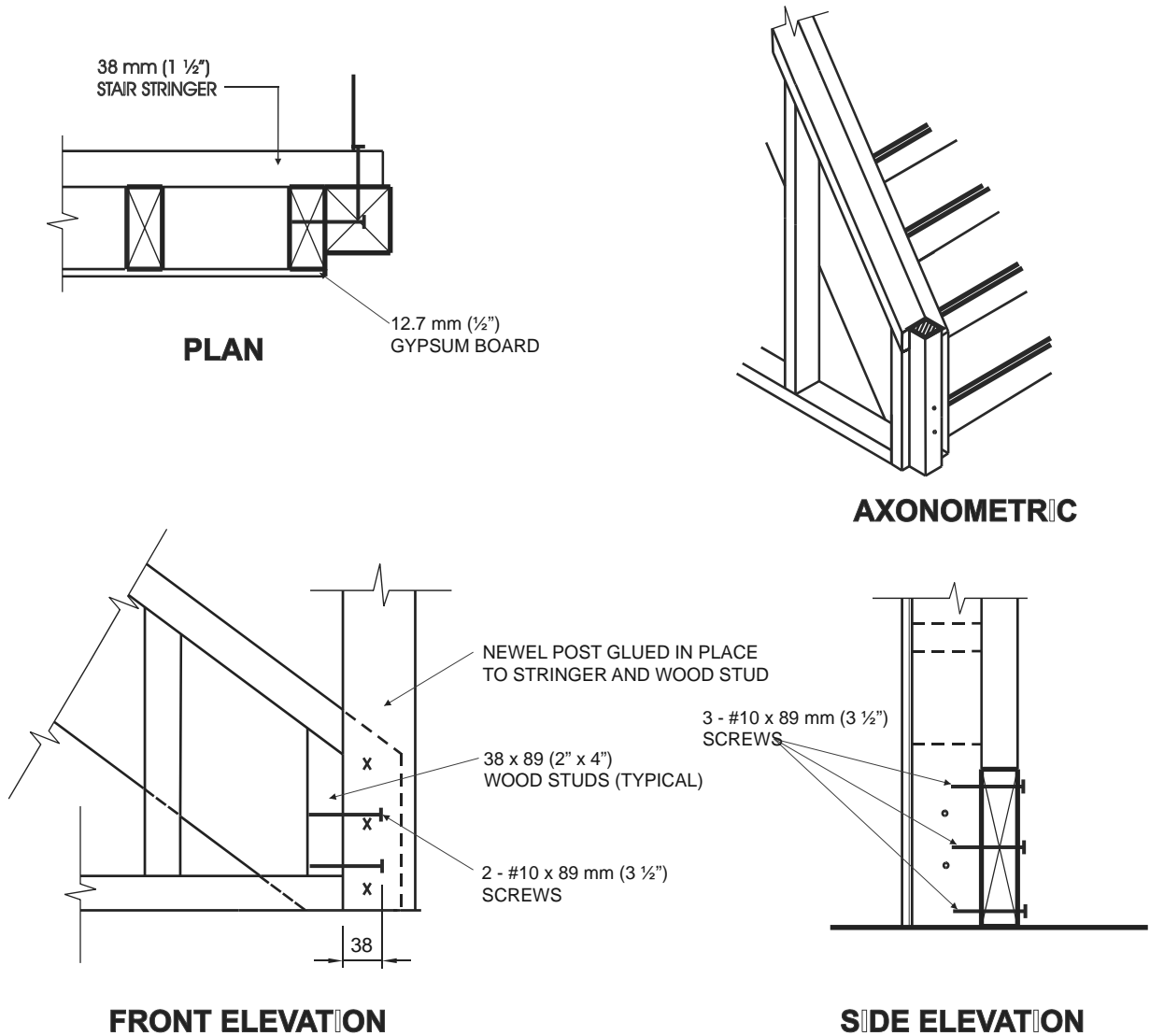
Detail IG-2

Interior Stair Guard Connection: Post Glued and Screwed to Stringer

Notes:

1. Stringer shall be oak or maple.
2. Only the first riser and tread are shown, for clarity.
3. Minimum thickness of riser shall be 12 mm (1/2").
4. Detail IC-1 or Detail IC-2, modified to suit a sloping application may be used for picket to rail connections.
5. Dimensions shown are in mm unless otherwise specified.

MAXIMUM SPACING BETWEEN POSTS	
Post Species	Maximum Span, m (ft-in)
Oak, Maple, Yellow Poplar, Hemlock, White Pine	3.30 (10'-10")
Column 1	2



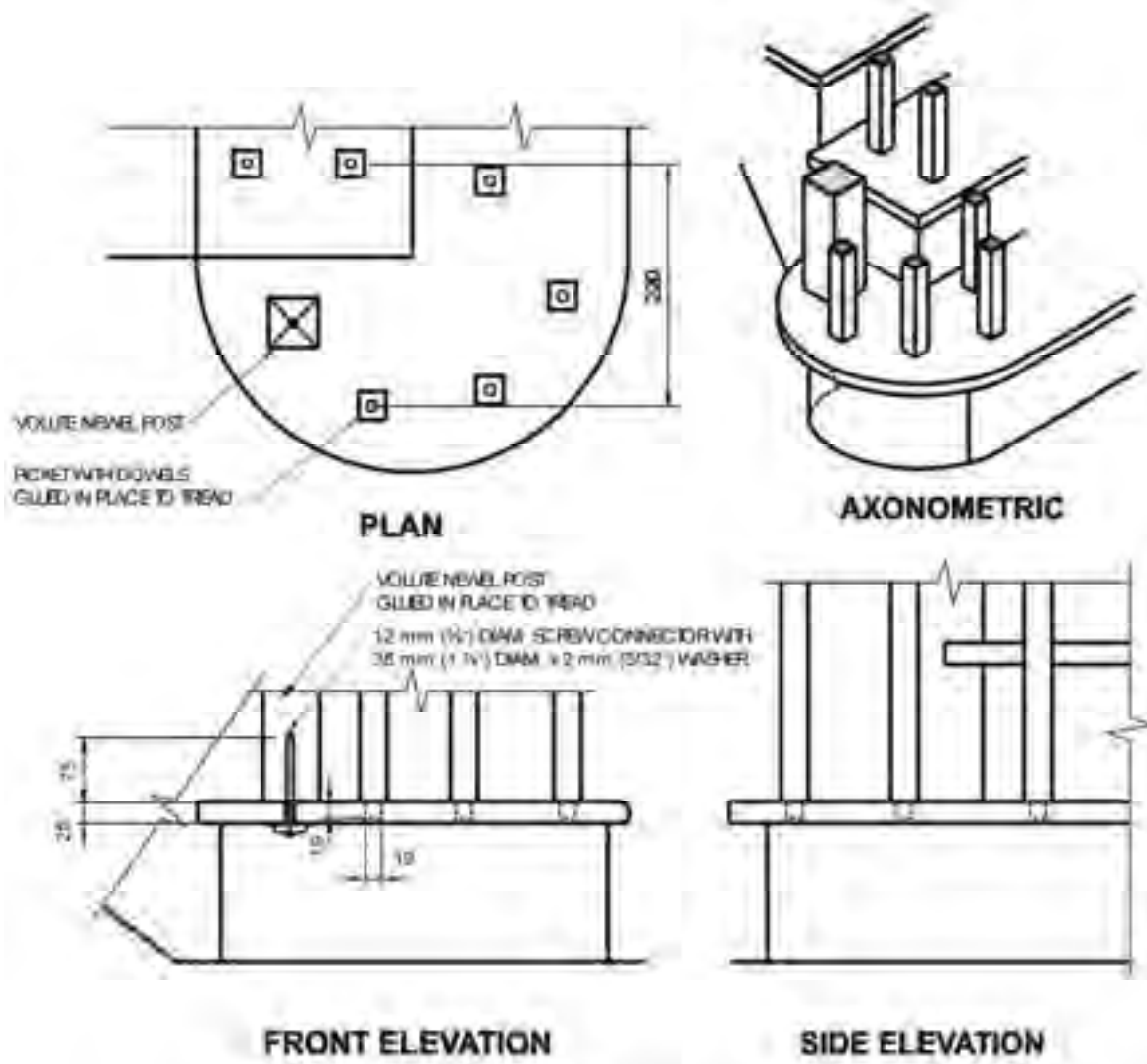
Detail IG-3

Interior Stair Guard Connection: Post Glued and Screwed to Stringer and Stud Wall

Notes:

1. Minimum thickness of riser shall be 12 mm (1/2").
2. Detail IC-1 or Detail IC-2, modified to suit a sloping application may be used for picket to rail connections.
3. Dimensions shown are in mm unless otherwise specified.

MAXIMUM SPACING BETWEEN POSTS	
Post Species	Maximum Span, m (ft-in)
Oak, Maple, Yellow Poplar, Hemlock, White Pine	3.30 (10'-10")
Column 1	2



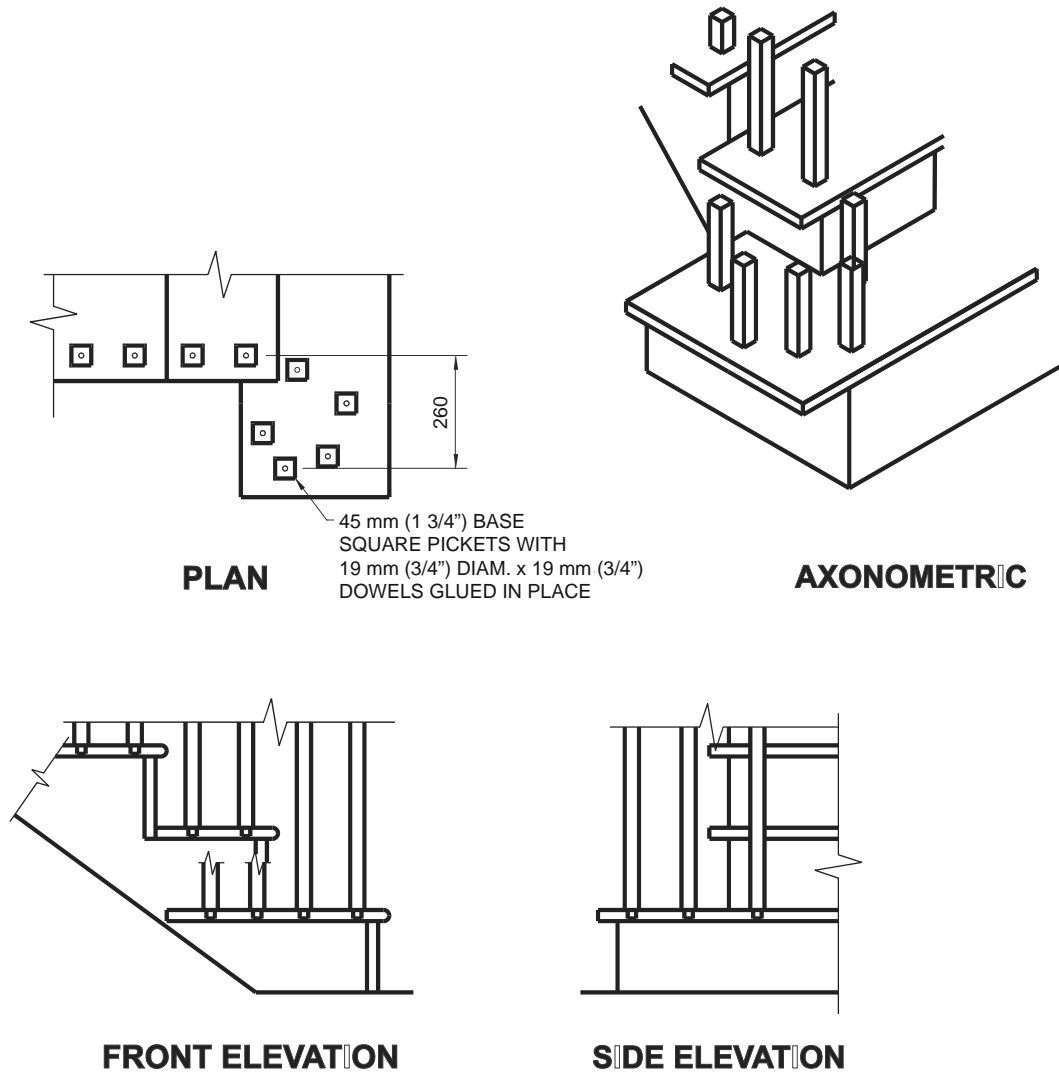
Detail IG-4

Interior Stair Guard Connection: Oak or Maple Post and Picket Volute

Notes:

1. Maximum permitted span is measured from the centre of the volute to a post or other solid support.
2. Other top rail systems may be used provided that the section modulus is not less than 24,000 mm³, measured about the vertical axis.
3. Newel post and pickets in the volute shall be oak or maple. See Table 3.1.2. for minimum sizes of pickets.
4. Detail IC-1 or Detail IC-2, modified to suit a sloping application may be used for picket to rail connections.
5. Dimensions shown are in mm unless otherwise specified.

MAXIMUM SPAN OF RAIL, MEASURED ALONG THE SLOPE	
Post and Picket Species	Maximum Span, m (ft-in)
Oak, Maple	4.30 (14'-1")
Column 1	2



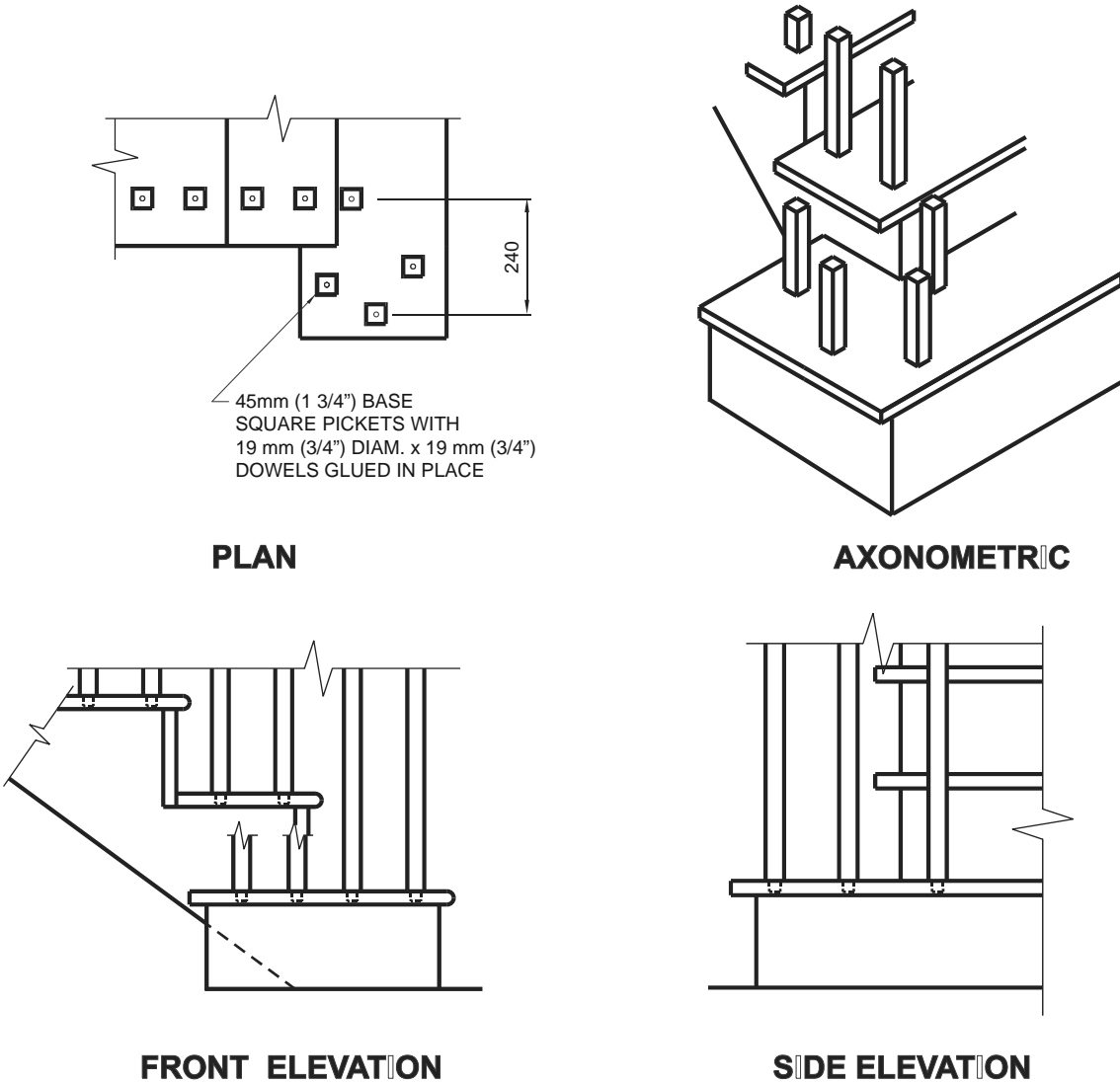
Detail IG-5

Interior Stair Guard Connection: Picket Volute, 260 mm (10¹/₄" Wide

Notes:

1. Maximum permitted span is measured from the centre of the volute to a post or other solid support.
2. Other top rail systems may be used provided that the section modulus is not less than 24,000 mm³, measured about the vertical axis.
3. See Table 3.1.2. for minimum sizes of pickets.
4. Detail IC-1 or Detail IC-2, modified to suit a sloping application may be used for picket to rail connections.
5. Dimensions shown are in mm unless otherwise specified.

MAXIMUM SPAN OF RAIL	
Picket Species	Maximum Span, m (ft-in)
Yellow Poplar, Hemlock, White Pine	1.80 (5'-11")
Column 1	2



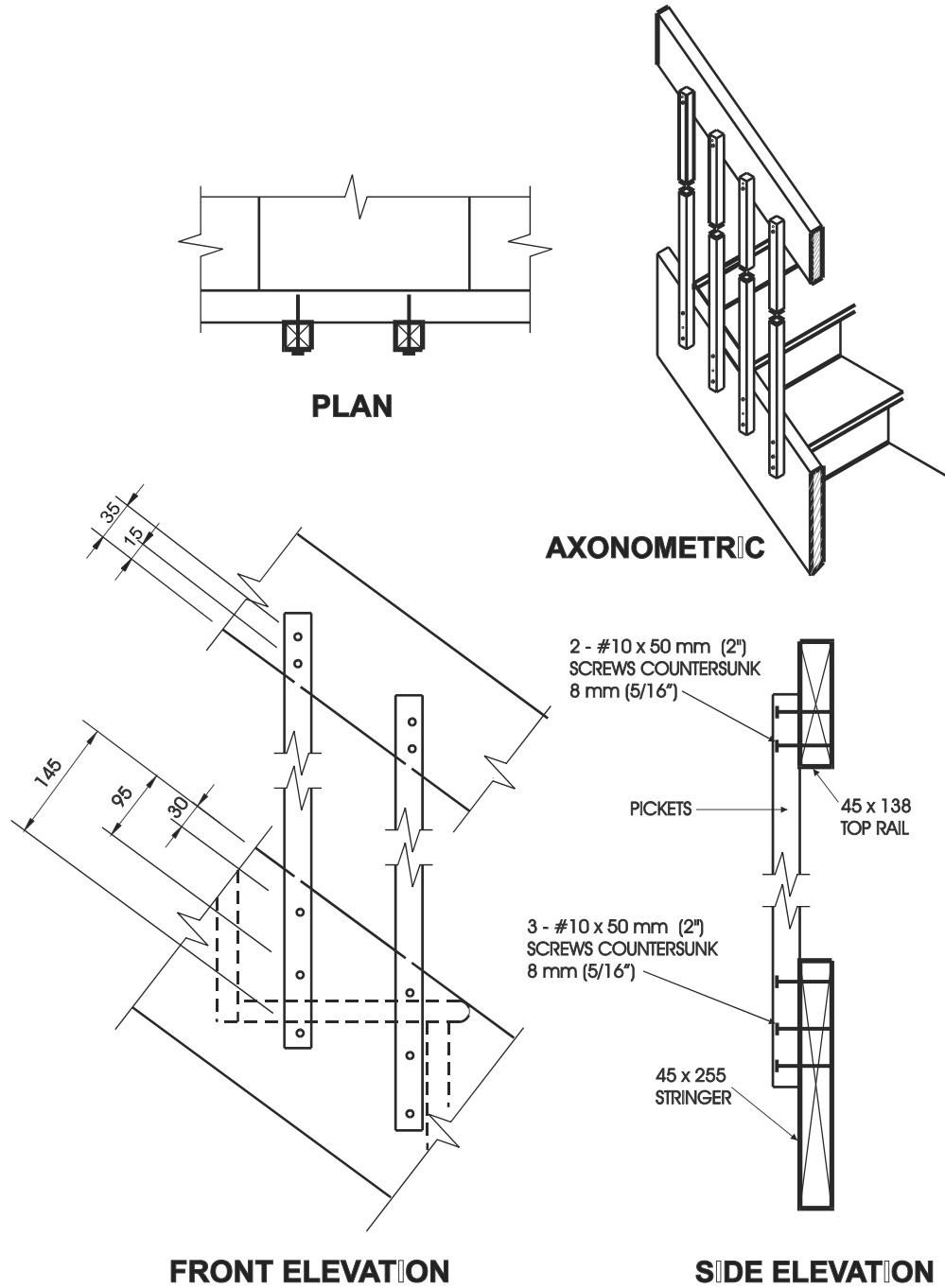
Detail IG-6

Interior Stair Guard Connection: Picket Volute, 240 mm (9 1/2") Wide

Notes:

1. Maximum permitted span is measured from the centre of the volute to a post or other solid support.
2. Other top rail systems may be used provided that the section modulus is not less than 24,000 mm³, measured about the vertical axis.
3. See Table 3.1.2. for minimum sizes of pickets.
4. Detail IC-1 or Detail IC-2, modified to suit a sloping application may be used for picket to rail connections.
5. Dimensions shown are in mm unless otherwise specified.

MAXIMUM SPAN OF RAIL	
Species	Maximum Span, m (ft-in)
Yellow Poplar, Hemlock, White Pine	1.80 (5'-11")
Column 1	2



Detail IH-1

Interior Stair Guard Connection: Cantilevered Picket Screwed to Stair Stringer

Notes:

1. Stair stringer shall be oak or maple.
2. Provide a suitable post, return, or solid support at each end of the guard.
3. See Table 3.1.2. for minimum sizes of pickets.
4. Dimensions shown are in mm unless otherwise specified.

Appendix A

Explanatory Material for SB-7

Appendix A to this Supplementary Standard is included for explanatory purposes only and does not form part of the requirements. The bold-faced reference numbers that introduce each item apply to the requirements in this Supplementary Standard.

A-1.1.1. Scope. A guard constructed in conformance with this Supplementary Standard is deemed to satisfy the requirements of Sentence 9.8.8.8.(2) of Division B.

Guard design in this Supplementary Standard is based on a height of 1 070 mm and a maximum clear spacing of 100 mm between pickets or balusters.

A-1.1.1.(2) Guards located on the exterior of a building are subject to deterioration as a result of hygrothermal, electrochemical or biochemical action.

A-1.2.1. Cantilever Action. Where guards incorporate wood posts that are continuous from the top of the guard to the ground, or where the tops of the posts are attached to a superstructure that is connected to the building, the cantilever assumption in the Supplementary Standards is no longer valid. An example of a continuous post is shown in Figure A-1.2.1.

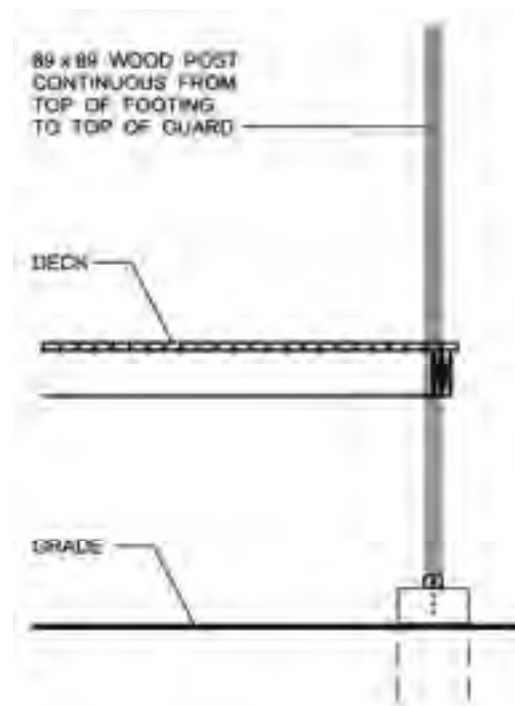


Figure A-1.2.1.
Typical Continuous Post

A-1.2.2. Classification. A Post and Rail System consists of a top rail that transfers horizontal loads to posts. The posts transfer the loads from the rail to the floor system. This system may incorporate a bottom rail that is anchored at each end to the posts. Infill panels or infill pickets are installed between the top rail and the floor or bottom rail. Examples of Post and Rail Systems are shown in Figure A-1.2.2.A.

The term “infill pickets” refers to an assembly of vertically oriented elements that span between the floor or bottom rail and the top rail. For the purpose of this Supplementary Standard, the words “picket” and “baluster” both relate to these individual elements.

The spacing of the posts in a Post and Rail System is detailed in this Supplementary Standard and is dictated by the ability of the posts to accept the design loads. The maximum spanning capacity of the rails is often not realised because it is dictated by the post spacing.

A Cantilevered Picket System consists of a top rail that transfers horizontal loads to pickets. The pickets transfer the loads from the top rail to the floor system. An example of a Cantilevered Picket System is shown in Figure A-1.2.2.B.

A guard classified as a Post and Rail System or a Cantilevered Picket System need not always terminate at a post if:

- (a) the top rail is connected adequately to an element capable of accepting the forces applied to it, or
- (b) the guard changes direction and the rails are adequately fastened at the return.

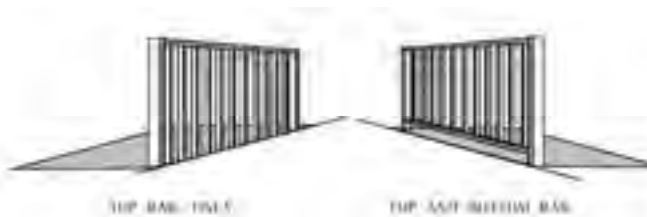


Figure A-1.2.2.A
Typical Post and Rail Systems



Figure A-1.2.2.B
Cantilevered Picket System

A-2.1.1. Lumber Grades. Whereas Northern Species is specified as the minimum lumber grade, Spruce-Pine-Fir, Douglas Fir-Larch and Hem-Fir may also be used since their structural properties exceed those of Northern Species. Cedar falls within the classification of Northern Species Group.

A-2.1.3. Floor Construction. The lateral loads acting on a guard are transferred from either the posts or the pickets to the floor system. Therefore, the floor system must be sufficiently strong to transfer these loads.

A-2.1.4. Connectors. Pre-drilling of wood elements may be required in order to avoid splitting of structural wood elements. Where a glued joint is required, an adhesive conforming to CSA Standard O112.4-M1977 (Polyvinyl Adhesives for Wood) and CSA Standard O112.8-M1977 (Polyvinyl Adhesives - Cross Linking, for Wood) is acceptable.

A-2.1.5. Decay-Resistant Lumber. Cedar is a species considered resistant to decay.

MMAH Supplementary Standard SB-8

Design, Construction and Installation of Anchorage Systems for Fixed Access Ladders

September 14, 2012

COMMENCEMENT

MMAH Supplementary Standard SB-8 comes into force on the 1st day of January, 2014.

© Copyright

© Copyright Queen's Printer for Ontario 2012

All rights reserved.

Questions regarding copyright, including reproduction and distribution, may be directed to the Director,
Building and Development Branch of the Ministry of Municipal Affairs and Housing.

SB-8 Design, Construction and Installation of Anchorage Systems for Fixed Access Ladders

Design

The design, construction and installation of the anchorage system for a fixed access ladder shall be capable of withstanding the anticipated loads from the ladder.

The following are the minimum criteria to be used in the design:

- The minimum design live load should be two loads of 1.1 kN each concentrated between any two consecutive attachments.
- Other loads, such as concentrated loads, loads due to ice, wind, rigging and impact, and dead loads, must be considered in the design.
- A safety factor of at least 4:1 should be applied in designing components for normal usage, and at least 10:1 for components supporting fall-arrest systems.

Attachment and Anchorage

The attachment method must be rated for the intended structural service and take into consideration the type of wall or member which will support the ladder.

- Expansion anchors should be avoided with masonry walls. Since anchor manufacturers' pull-out ratings are usually given for poured concrete walls, they cannot be reliably attained in masonry walls.
- Through-bolted connections, or equivalent, must be used for masonry walls, and other walls for which there is no anchor manufacturers' pull-out rating. Generally, through-bolted connections should be used wherever practicable.
- Attachment and anchor bolts should have a minimum diameter of 12 mm.
- Maximum spacing of attachment points for a steel ladder with side rails shall be 3 m.
- For different materials or extra loads, this maximum spacing must be adjusted in accordance with recognized design practice.

To provide an improved margin of safety, there should be two means of anchoring the top of the ladder. This may be accomplished by fastening the side rail extension above the top of the access/egress level to the roof.

If a ladder is to be attached to an existing wall, the structural soundness of the wall must be investigated to ensure it is capable of supporting the ladder.

For additional information on fixed access ladders refer to Engineering Data Sheet 2-04, issued by the Ministry of Labour.

MMAH Supplementary Standard SB-9

Requirements for Soil Gas Control

September 14, 2012

COMMENCEMENT

MMAH Supplementary Standard SB-9 comes into force on the 1st day of January, 2014.

© Copyright

© Copyright Queen's Printer for Ontario 2012

All rights reserved.

Questions regarding copyright, including reproduction and distribution, may be directed to the Director,
Building and Development Branch of the Ministry of Municipal Affairs and Housing.

SB-9 Requirements for Soil Gas Control

Section 1 Soil Gas Control in Masonry Walls

1.1. Sealing of Masonry Walls

- (1) Masonry walls required to provide a barrier to soil gas ingress shall
 - (a) include a course of masonry units without voids, or
 - (b) be sealed with flashing material extending across the full width of the masonry.
- (2) The masonry course or flashing described in Sentence (1) shall
 - (a) be located at the level of the adjoining floor and be sealed to it in accordance with Subsection 3.3., or
 - (b) in the absence of a floor, be located at the level of the ground cover required by Article 9.18.6.1. of Division B of the Building Code and be sealed to it.

Section 2 Soil Gas Control in Underground Roofs

2.1. Sealing of Underground Roofs

- (1) Waterproofing systems for roofs of underground structures shall be sealed to the soil gas barrier in the walls.

Section 3 Soil Gas Control in Floors

3.1. Soil Gas Barriers in Floors

- (1) Where the floor-on-ground is a concrete slab, the soil gas barrier shall be
 - (a) installed below the slab, or
 - (b) applied to the top of the slab, provided a separate floor is installed over the slab.
- (2) Where the soil gas barrier is installed below a slab-on-ground, joints in the barrier shall be lapped not less than 300 mm.
- (3) Where the soil gas barrier is installed above a slab-on-ground, joints in the barrier shall be sealed.
- (4) Where installed in conjunction with a framed floor-on-ground, the soil gas barrier shall be installed in accordance with Articles 9.25.3.2. and 9.25.3.3. of Division B of the Building Code.

3.2. Providing for Subfloor Depressurization

- (1) Except as required in Sentence (3), granular material shall be installed below the floor-on-ground according to Sentence 9.16.2.1.(1) of Division B of the Building Code.

- (2) A pipe not less than 100 mm in diameter shall be installed vertically through the floor, at or near its centre, such that
 - (a) its bottom end opens into the granular fill described in Sentence (1), and
 - (b) its top end will permit connection to depressurization equipment.
- (3) The granular material described in Sentence (1), near the centre of the floor, shall be not less than 150 mm deep for a radius of not less than 300 mm centred on the pipe described in Sentence (2).
- (4) The upper end of the pipe described in Sentence (2) shall be provided with a removable seal.
- (5) The pipe described in Sentence (2) shall be clearly labelled to indicate that it is intended only for the removal of soil gas from below the floor-on-ground.
- (6) Except as provided in Sentence (8), when a building constructed in accordance with Sentences (1) to (5) is complete, testing shall be conducted according to HC Pub. 4171, "Guide for Radon Measurements in Residential Dwellings (Homes), 2008", to determine the radon concentration in the building.
- (7) A copy of the results of testing required in Sentence (6) shall be provided by the building owner to the authority having jurisdiction.
- (8) The testing required in Sentence (6) shall include basement concentration measurements.
- (9) Where the average annual radon concentration determined as described in Sentences (6) and (8) exceeds 200 Bq/m³ in the normal occupancy area, a subfloor depressurization system shall be installed to reduce the radon concentration to a level below 200 Bq/m³ in the normal occupancy area.
- (10) Where a subfloor depressurization system is installed,
 - (a) makeup air shall be provided as specified in Article 9.32.3.8. of Division B of the Building Code, and
 - (b) measures shall be taken to ensure that any resultant decrease in soil temperature will not adversely affect the foundation.

3.3. Sealing of the Perimeter and Penetrations

- (1) A floor-on-ground shall be sealed around its perimeter to the inner surfaces of adjacent walls using flexible sealant.
- (2) All penetrations of a floor-on-ground by pipes or other objects shall be sealed against soil gas leakage.
- (3) All penetrations of a floor-on-ground that are required to drain water from the floor surface shall be sealed in a manner that prevents the upward flow of soil gas without preventing the downward flow of liquid water.

Notes to SB-9 Soil Gas Barriers:

There are two principal methods of excluding soil gas:

- Sealing the interface between the soil and the occupied space, so far as is reasonably practicable.
- Ensuring that the pressure difference across the soil/space interface is positive (i.e., towards the outside) so that inward soil gas flow through any remaining leaks will be prevented.

Soil Gas Barriers. The requirements for Soil Gas Control in Walls, Soil Gas Barriers, and Sealing of the Perimeter and Penetrations, are illustrated in the following drawings. Sealing of penetrations of the slab also applies to hollow metal and masonry columns. Not only the perimeters but also the centres of such columns must be sealed or blocked.

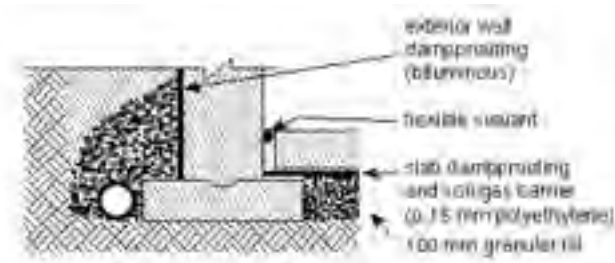


Figure SB-9A
Dampproofing and Soil Gas Control at Foundation Wall/Floor Junctions with Solid Walls

The requirement regarding drainage openings in slabs can be satisfied with any of a number of proprietary devices which prevent soil gas entry through floor drains. Some types of floor drains incorporate a trap which is connected to a nearby tap so that the trap is filled every time the tap is used. This is intended to prevent the entry of sewer gas but would be equally effective against the entry of soil gas.

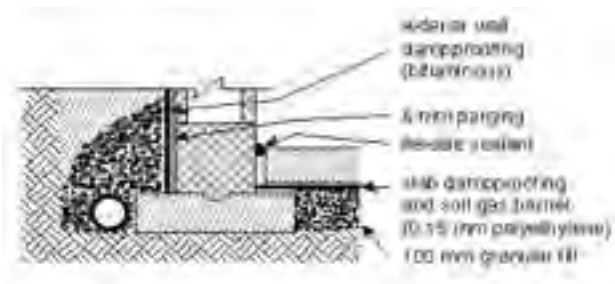


Figure SB-9B
Dampproofing and Soil Gas Control at Foundation Wall/Floor Junctions with Hollow Walls

MMA Supplementary Standard SB-10

Energy Efficiency Requirements

December 22, 2016 update

COMMENCEMENT

MMAH Supplementary Standard SB-10 comes into force on the 1st day of January, 2014.

m4 Ruling of the Minister of Municipal Affairs (Minister's Ruling) MR-16-S-27 takes effect on the 1st day of January, 2017.

ACKNOWLEDGEMENT

The Ministry wishes to thank ASHRAE for permission to reproduce material from ANSI/ASHRAE/USGBC/IES Standard 189.1-2009.

© Copyright

© Copyright Queen's Printer for Ontario 2016

All rights reserved.

Questions regarding copyright, including reproduction and distribution, may be directed to the Director,
Building and Development Branch of the Ministry of Municipal Affairs.

NOMENCLATURE

This Supplementary Standard is organized into a hierarchy of Divisions, Chapters, Parts or Sections, Subsections, Articles, Sentences, Clauses and Subclauses.

FOREWORD

This Supplementary Standard contains 5 Divisions as follows:

Division 1 addresses general requirements. This updated Supplementary Standard includes new referenced standards and updated versions of previously referenced standards.

Division 2 contains requirements for the design and construction of buildings which may continue to be used after December 31, 2016 subject to Clause 12.2.1.2.(2)(a) of Division B of the Building Code which requires an additional minimum 13% increase in energy efficiency levels. The energy efficiency design of buildings is required to meet one of the following four compliance paths plus a further minimum 13 percent increase in energy efficiency levels:

1. achieve the energy efficiency levels attained by conforming to ANSI/ASHRAE/IES Standard 90.1-2010, “Energy Standard for Buildings Except Low-Rise Residential Buildings” as modified by Chapter 2 of this Division,
2. exceed by not less than 5% the energy efficiency levels attained by conforming to ANSI/ASHRAE/IES 90.1-2010, “Energy Standard for Buildings Except Low-Rise Residential Buildings”,
3. exceed by not less than 25% the energy efficiency levels attained by conforming to CCBFC NRCC 38730, “1997 Model National Energy Code for Buildings” (Note: The 1997 MNECB-based compliance path is revoked on January 1, 2018 and will no longer be a design option after December 31, 2017. See Minister’s Ruling MR-16-S-27.), or
4. achieve the energy efficiency levels attained by conforming to CCBFC NRCC 54435, “2011 National Energy Code of Canada for Buildings” as modified by Chapter 3 of this Division.

Division 2 outlines the modifications mentioned above. These modifications enhance the building envelope provisions of ANSI/ASHRAE/IES Standard 90.1-2010 and enables the use of Canadian testing procedures for HVAC and service water heating equipment. Editorial changes have also been introduced to Division 2 in this updated edition.

Division 3 contains requirements for the design and construction of buildings for which a permit has been applied for after December 31, 2016. In this updated Supplementary Standard, Division 3 has been substantially revised. The existing sample compliance path has been replaced by new compliance paths. The compliance paths are based on contemporary energy codes and standards and contain additional requirements to achieve, on average, a 13 percent improvement over the efficiency level required by Sentence 12.2.1.1.(2) of Division B of the Building Code. Division 3 contains a transition provision and revised CO₂e factors in Chapter 1 as well as the following three compliance paths based on:

1. ANSI/ASHRAE/IES Standard 90.1-2013, “Energy Standard for Buildings Except Low-Rise Residential Buildings”, and additional requirements introduced through Chapter 2,
2. CCBFC NRCC 56191, “2015 National Energy Code of Canada for Buildings” and additional requirements introduced through Chapter 3, and
3. ANSI/ASHRAE/USGBC/IES Standard 189.1-2014, “Standard for the Design of High-Performance Green Buildings Except Low-Rise Residential Buildings”.

Divisions 2 and 3 also describe limitations on peak electric demand and annual carbon dioxide emissions.

Division 4 contains simplified energy efficiency requirements for the construction of certain non-residential buildings within the scope of Part 9 of Division B of the 2012 Building Code for which a permit has been applied for before January 1, 2017. No changes were introduced to Division 4 in this updated Supplementary Standard.

Division 5 contains simplified energy efficiency requirements for the construction of certain non-residential buildings within the scope of Part 9 of Division B of the 2012 Building Code for which a permit has been applied for after December 31, 2016. Division 5 was revised consistent with changes made to Division 3 in this updated edition. The application of the above documents to existing buildings is limited to the requirements of Part 10 and Part 11 of Division B of the Building Code.

m₄ SB-10 Energy Efficiency Requirements

Division 1

General

1.1.	General	
1.1.1.	Application of Supplementary Standard SB-10	3
1.2.	Terms and Abbreviations	
1.2.1.	Definitions of Words and Phrases.....	4
1.2.2.	Symbols and Other Abbreviations	4
1.3.	Referenced Documents and Organizations	
1.3.1.	Referenced Documents	5
1.3.2.	Abbreviations	7

Division 1

General

Section 1.1. General

1.1.1. Application of Supplementary Standard SB-10

1.1.1.1. Application

(1) This Supplementary Standard applies to the energy efficiency design and *construction* of *buildings* required to comply with Sentences 12.2.1.1.(2) and 12.2.1.2.(2) and Subsections 12.2.2. and 12.2.3. of Division B of the *Building Code*.

- (2) The energy efficiency of existing *buildings* shall comply with
- (a) Part 10 of Division B of the *Building Code* with respect to change of use, or
 - (b) Part 11 of Division B of the *Building Code* for renovation.

1.1.1.2. Energy Efficiency Design Before January 1, 2017

(1) Except as permitted in Sentence (2), the energy efficiency design and *construction* of *buildings* required to comply with Sentence 12.2.1.1.(2) of Division B of the *Building Code* shall comply with Division 2 of this Supplementary Standard.

- (2) The energy efficiency of a *building* or part of a *building* may conform to the design requirements of Division 4 of this Supplementary Standard, if the *building* or part of the *building*,
- (a) is within the scope of Part 9 of Division B of the *Building Code*,
 - (b) does not contain a *residential occupancy*,
 - (c) does not use *electric space heating*, and
 - (d) is intended for occupancy on a continuing basis during the winter months.

1.1.1.3. Energy Efficiency Design After December 31, 2016

(1) Except as permitted in Sentence (2), the energy efficiency design and *construction* of *buildings* required to comply with Sentence 12.2.1.2.(2) of Division B of the *Building Code* shall comply with Division 3 of this Supplementary Standard.

- (2) The energy efficiency of a *building* or part of a *building* may conform to the design requirements of Division 5 of this Supplementary Standard, if the *building* or part of the *building*,
- (a) is within the scope of Part 9 of Division B of the *Building Code*,
 - (b) does not contain a *residential occupancy*,
 - (c) does not use *electric space heating*, and
 - (d) is intended for occupancy on a continuing basis during the winter months.

1.1.1.4. Internal Cross-References

(1) If a provision of this Supplementary Standard contains a reference to another provision of this Supplementary Standard but no Division is specified, both provisions are in the same Division of this Supplementary Standard.

Section 1.2. Terms and Abbreviations

1.2.1. Definitions of Words and Phrases

1.2.1.1. Non-Defined Terms

(1) Definitions of words and phrases used in this Supplementary Standard that are not included in the list of definitions in Articles 1.4.1.2. and 1.4.1.3. of Division A of the *Building Code* and are not defined in another provision of the Code shall have the meanings that are commonly assigned to them in the context in which they are used, taking into account the specialized use of terms by the various trades and professions to which the terminology applies.

1.2.1.2. Defined Terms

(1) Each of the words and terms in italics in this Supplementary Standard has the same meaning as in subsection 1(1) of the *Building Code Act, 1992* or Clause 1.4.1.2.(1)(b) of Division A of the *Building Code*.

(2) In this Supplementary Standard,

Carbon dioxide equivalent (CO₂e) means a measure used to compare the impact of various greenhouse gases based on their global warming potential.

1.2.2. Symbols and Other Abbreviations

1.2.2.1. Symbols and Other Abbreviations

(1) Where used in this Supplementary Standard, a symbol or abbreviation listed in Column 2 of Table 1.4.2.1. of Division A of the *Building Code* has the meaning listed opposite it in Column 3.

(2) The abbreviations listed in Column 2 of Table 1.2.2.1. also apply to this Supplementary Standard and have the meaning listed opposite it in Column 3.

Table 1.2.2.1.
Symbols and Abbreviations
Forming Part of Sentence 1.2.2.1.(2)

Item	Abbreviation	Meaning
1	CO ₂ e	<i>carbon dioxide equivalent</i>
2	GJ	gigajoules
3	kWh	kilowatt-hours
4	LPG	liquified petroleum gas
Column 1	2	3

Section 1.3. Referenced Documents and Organizations

1.3.1. Referenced Documents

1.3.1.1. Effective Date

(1) Except as provided in Table 1.3.1.2. of this Supplementary Standard, the documents referenced in this Supplementary Standard shall include all amendments, revisions and supplements effective to June 26, 2015.

1.3.1.2. Applicable Editions

(1) Unless otherwise specified in this Supplementary Standard, documents referenced in this Standard shall be the editions designated in Column 2 of Table 1.3.1.2. of Division B of the *Building Code*.

(2) Where ANSI/ASHRAE/IES Standard 90.1, “Energy Standard for Buildings Except Low-Rise Residential Buildings” is referenced in this Supplementary Standard, it shall be the edition designated in Table 1.3.1.2.

(3) Where CCBFC NRCC 38730, “Model National Energy Code of Canada for Buildings” or CCBFC NRCC 54435 or 56191, “National Energy Code of Canada for Buildings” is referenced in this Supplementary Standard, it shall be the edition designated in Table 1.3.1.2. (Note: The reference to CCBFC NRCC 38730, “Model National Energy Code of Canada for Buildings” is revoked on January 1, 2018. See Minister’s Ruling MR-16-S-27.)

Table 1.3.1.2.
Referenced Documents
 Forming Part of Sentences 1.3.1.2.(1) to (3)

Issuing Agency	Document Number	Title of Document	Supplementary Standard Reference
ANSI/ASHRAE/IES	90.1-2010 (excluding amendments issued)	Energy Standard for Buildings Except Low-Rise Residential Buildings	Division 1 Chapters 1 and 2 of Division 2
ANSI/ASHRAE/IES	90.1-2013 (including amendments issued to June 26, 2015)	Energy Standard for Buildings Except Low-Rise Residential Buildings	Division 3 Chapters 1 and 2 of Division 3
ANSI/ASHRAE/ USGBC/IES	189.1-2014	Standard for the Design of High-Performance Green Buildings Except Low-Rise Residential Buildings	Division 3 Chapter 1 of Division 3
CSA	CAN/CSA-A440.2-14	Fenestration Energy Performance	1.1.1.3.(5) of Chapter 1 of Divisions 2, and 1.1.1.4.(5) of Chapter 1 and 1.1.1.6 (8) of Chapter 3 of Division 3
CSA	C390-2010	Test Methods, Marking Requirements, and Energy Efficiency Levels for Three-Phase Induction Motors	1.1.1.7.(5) of Chapter 1 of Divisions 2 and 3
CCBFC	NRCC 38730 -1997	Model National Energy Code of Canada for Buildings (Note: This row is revoked on January 1, 2018. See Minister's Ruling MR-16-S-27.)	Division 1 Chapter 1 in Division 2
CCBFC	NRCC 54435 -2011	National Energy Code of Canada for Buildings	Division 1 Chapters 1 and 3 of Division 2
CCBFC	NRCC 56191 -2015	National Energy Code of Canada for Buildings	Division 1 Chapters 1 and 3 of Division 3
NFRC	NFRC 100-2014	Procedure for Determining Fenestration Product U-factors	1.1.1.4.(5) of Chapter 1 and 1.1.1.6.(8) of Chapter 3 of Division 3
NFRC	NFRC 200-2014	Procedure for Determining Fenestration Product Solar Heat Gain Coefficient and Visible Transmittance at Normal Incidence	1.1.1.4.(5) of Chapter 1 and 1.1.1.6.(8) of Chapter 3 of Division 3
Column 1	2	3	4

1.3.2. Abbreviations

1.3.2.1. Abbreviations of Proper Names

- (1) Where used in this Supplementary Standard, abbreviations of proper names listed in Column 1 of Table 1.3.2.1. in Division B of the *Building Code* shall have the meaning assigned opposite it in Column 2.
- (2) For the purpose of this Supplementary Standard,
 - (a) 2010 ANSI/ASHRAE/IES 90.1, means ANSI/ASHRAE/IES Standard 90.1-2010, “Energy Standard for Buildings Except Low-Rise Residential Buildings”,
 - (b) 2013 ANSI/ASHRAE/IES 90.1, means ANSI/ASHRAE/IES Standard 90.1-2013, “Energy Standard for Buildings Except Low-Rise Residential Buildings”,
 - (c) 2014 ANSI/ASHRAE/USGBC/IES Standard 189.1 means ANSI/ASHRAE/USGBC/IES Standard 189.1-2014, “Standard for the Design of High-Performance Green Buildings Except Low-Rise Residential Buildings”,
 - (d) 1997 MNECB means CCBFC NRCC 38730-1997, “Model National Energy Code of Canada for Buildings”, (Note: Clause (d) is revoked on January 1, 2018. See Minister’s Ruling MR-16-S-27.)
 - (e) 2011 NECB means CCBFC NRCC 54435-2011, “National Energy Code of Canada for Buildings”, and
 - (f) 2015 NECB means CCBFC NRCC 56191-2015, “National Energy Code of Canada for Buildings”.

Division 2

Energy Efficiency Design Before January 1, 2017

(Applies to construction for which a permit has been applied for before January 1, 2017)

Chapter 1 General

1.1.	General	
1.1.1.	Scope.....	11
1.1.2.	Energy Efficiency Design, Carbon Dioxide Equivalents and Peak Electric Demand.....	11
1.1.3.	Chapter 2 and Chapter 3.....	13
1.2.	Application	
1.2.1.	Application of 2010 ANSI/ASHRAE/IES 90.1, 1997 MNECB and 2011 NECB (Note: The reference to the 1997 MNECB is revoked on January 1, 2018.).....	13
1.3.	Climatic Zones	
1.3.1.	Climatic Zone Numbers.....	14

Chapter 2 Additional Requirements to 2010 ANSI/ASHRAE/IES 90.1

1.1.	Changes and Additional Requirements	
1.1.1.	Changes and Additional Requirements to 2010 ANSI/ASHRAE/IES 90.1.....	17

Chapter 3 Additional Requirements to the 2011 NECB

1.1.	Changes and Additional Requirements	
1.1.1.	Changes and Additional Requirements to the 2011 NECB.....	33

FOREWORD

This Division contains requirements for the design and construction of buildings which may continue to be used after December 31, 2016 subject to Clause 12.2.1.2.(2)(a) of Division B of the Building Code which requires an additional minimum 13% increase in energy efficiency levels. The energy efficiency design of buildings is required to meet one of the following four compliance paths plus a further minimum 13 percent increase in energy efficiency levels:

1. achieve the energy efficiency levels attained by conforming to ANSI/ASHRAE/IES Standard 90.1-2010, “Energy Standard for Buildings Except Low-Rise Residential Buildings” as modified by Chapter 2 of this Division,
2. exceed by not less than 5% the energy efficiency levels attained by conforming to ANSI/ASHRAE/IES 90.1-2010, “Energy Standard for Buildings Except Low-Rise Residential Buildings”,
3. exceed by not less than 25% the energy efficiency levels attained by conforming to CCBFC NRCC 38730, “1997 Model National Energy Code for Buildings” (Note: The 1997 MNECB-based compliance path is revoked on January 1, 2018 and will no longer be a design option after December 31, 2017. See Minister’s Ruling MR-16-S-27.), or
4. achieve the energy efficiency levels attained by conforming to CCBFC NRCC 54435, “2011 National Energy Code of Canada for Buildings” as modified by Chapter 3 of this Division.

This Division outlines the modifications mentioned above. These modifications enhance the building envelope provisions of ANSI/ASHRAE/IES Standard 90.1-2010, “Energy Standard for Buildings Except Low-Rise Residential Buildings” and enables the use of Canadian testing procedures for HVAC and service water heating equipment.

Certain buildings and parts of buildings are exempted from the energy efficiency provisions in this Division.

Compliance with this Division does not necessarily ensure that the actual annual energy cost of a building is less than or equal to the theoretical values arrived at using the building energy cost budget method of ANSI/ASHRAE/IES Standard 90.1-2010, “Energy Standard for Buildings Except Low-Rise Residential Buildings” or building energy performance compliance of CCBFC NRCC 38730, “1997 Model National Energy Code for Buildings” or CCBFC NRCC 54435, “2011 National Energy Code of Canada for Buildings”. (Note: The reference to the 1997 MNECB is revoked on January 1, 2018. See Minister’s Ruling MR-16-S-27.) Factors such as weather, workmanship, depreciation of the thermal resistance of building materials, occupant/user lifestyle, building operation and maintenance impact on the actual energy consumption of a building.

Recommended Resource Material: ANSI/ASHRAE/IES Standard 90.1-2010 User’s Manual

Division 2

Chapter 1

General

Section 1.1. General

1.1.1. Scope

1.1.1.1. Scope

(1) Except as provided in Clause 12.2.1.2.(2)(a) of Division B of the *Building Code*, this Division applies to *construction* for which a permit has been applied for before January 1, 2017.

1.1.2. Energy Efficiency Design, Carbon Dioxide Equivalents and Peak Electric Demand

1.1.2.1. Energy Efficiency Design

- (1) Except as provided in Sentence (2) and Article 1.2.1.1. and except as permitted in Sentence (3), the energy efficiency of all *buildings* shall be designed to
- (a) exceed by not less than 25% the energy efficiency levels attained by conforming to the 1997 MNECB, (Note: Clause (a) is revoked on January 1, 2018. See Minister's Ruling MR-16-S-27.), (See Appendix A.)
 - (b) exceed by not less than 5% the energy efficiency levels attained by conforming to 2010 ANSI/ASHRAE/IES 90.1,
 - (c) achieve the energy efficiency levels attained by conforming to 2010 ANSI/ASHRAE/IES 90.1 and Chapter 2, or
 - (d) achieve the energy efficiency levels attained by conforming to the 2011 NECB and Chapter 3. (See Appendix A.)
- (2) The requirements of Clause (1)(b) do not apply to a *building* in which *electric space heating* is used.
- (3) The requirements of Clause (1)(b) may be met by conforming to the corresponding requirements of Chapter 2.
- (4) Where compliance with energy efficiency requirements is achieved in accordance with Clause 1.1.2.1.(1)(a), lighting and ventilation controls and strategies recognized by this Division may be accounted as energy credits.
- (5) Energy efficiency requirements do not apply to *buildings* or parts of *buildings* described in Article 1.2.1.1.

1.1.2.2. Carbon Dioxide Equivalents

(1) The annual CO₂e emission level from a *building* shall be determined in accordance with good engineering practice using the CO₂e emission factors listed in Table 1.1.2.2.

Table 1.1.2.2.
CO₂e Emission Factors
Forming Part of Sentence 1.1.2.2.(1)

<i>Building</i> Energy Sources	CO ₂ e, (kg/kWh)
Grid Delivered Electricity (marginal based on natural gas)	0.400
LPG or Propane	0.274
Fuel Oil	0.312
Gasoline	0.309
Natural Gas	0.191
Column 1	2

(2) Except as provided in Sentences (3) to (5), the annual CO₂e emission level from a *building* required to comply with Article 1.1.2.1., shall not exceed the level established by

- (a) Sections 5 to 10 of 2010 ANSI/ASHRAE/IES 90.1 and Chapter 2, or
- (b) Parts 1 to 7 of the 2011 NECB and Chapter 3.

(3) Where the energy efficiency of a *building* is determined by Clause 1.1.2.1.(1)(b), the annual CO₂e emission level from a *building* shall be reduced by at least 5 percent from the level established by 2010 ANSI/ASHRAE/IES 90.1.

(4) Where the energy efficiency of a *building* is determined by Clause 1.1.2.1.(1)(a), the annual CO₂e emission level from a *building* shall be reduced by at least 25 percent from the level established by the 1997 MNECB. (Note: Sentence (4) is revoked on January 1, 2018. See Minister's Ruling MR-16-S-27.)

(5) The annual CO₂e emission level from a *building* is deemed to comply with Sentence (3) or (4) if the level complies with the level established by Sentence (2). (Note: The reference to "or (4)" is struck out on January 1, 2018. See Minister's Ruling MR-16-S-27.)

1.1.2.3. Peak Electric Demand

(1) Except as provided in Sentence (2), the peak electric demand of a *building* required to comply with Article 1.1.2.1. shall not exceed the level established by

- (a) Sections 5 to 10 of 2010 ANSI/ASHRAE/IES 90.1 and Chapter 2, or
- (b) Parts 1 to 7 of the 2011 NECB and Chapter 3.

(2) The peak electric demand of a *building* is deemed to comply with Sentence (1), if the *building* design meets the prescriptive requirements set in 2010 ANSI/ASHRAE/IES 90.1 and Chapter 2 or in the 2011 NECB and Chapter 3 for the energy efficiency of the cooling equipment, fan power limitations for cooling and ventilation systems, and interior lighting power density.

1.1.3. Chapter 2 and Chapter 3

1.1.3.1. Chapter 2

(1) Chapter 2 contains additional requirements and changes to 2010 ANSI/ASHRAE/IES 90.1 and applies where compliance with energy efficiency requirements is achieved in accordance with Clause 1.1.2.1.(1)(c).

(2) Where compliance with energy efficiency requirements is achieved in accordance with Clause 1.1.2.1.(1)(b), energy efficiency of the *building* or part of the *building* is permitted to conform to the respective requirements of Chapter 2 in lieu of the corresponding requirements in 2010 ANSI/ASHRAE/IES 90.1. (See Appendix A.)

1.1.3.2. Chapter 3

(1) Chapter 3 contains additional requirements and changes to the 2011 NECB and applies where compliance with energy efficiency requirements is achieved in accordance with Clause 1.1.2.1.(1)(d).

Section 1.2. Application

1.2.1. Application of 2010 ANSI/ASHRAE/IES 90.1, 1997 MNECB and 2011 NECB (Note: The reference to the 1997 MNECB is revoked on January 1, 2018. See Minister's Ruling MR-16-S-27.)

1.2.1.1. Exceptions

- (1) The requirements of Articles 1.1.2.1. to 1.1.2.3. of this Chapter do not apply to
 - (a) a *building* or part of a *building* of *residential occupancy* that is within the scope of Part 9 of Division B of the *Building Code*,
 - (b) a *heritage building*,
 - (c) structures such as construction trailers, tents and *air-supported structures*,
 - (d) a *building* or part of a *building* where the environmental condition within the *building* is governed by the process, operation of the *building* or permanent openings to the outdoors or to unconditioned environments,
 - (e) a *building* or part of a *building* where it can be shown that meeting the requirements of Article 1.1.2.1. does not conserve any energy,
 - (f) equipment or processes that use energy for manufacturing, industrial and commercial purposes, and
 - (g) *occupancies* listed in Table 1.2.1.1.
- (2) The following *buildings* or parts of *buildings* need not to comply with envelope requirements:
 - (a) any *building* space which uses energy for space conditioning at a rate less than 12 W/m² under peak conditions,
 - (b) warehouses and storage rooms where the design indoor temperature does not exceed 10°C,
 - (c) except conditioned spaces of *buildings* exposed to unheated *storage garages* and unheated storage rooms, unheated *storage garages* and unheated storage rooms, and
 - (d) where a part of a single enclosed space is heated.
- (3) Where specifically noted in this Supplementary Standard or documents referenced in Sentence 12.2.1.1.(2), certain other *buildings* or elements of *buildings* shall be exempt.
- (4) This Supplementary Standard or the requirements of Sentences 12.2.1.1.(1) and 12.2.1.1.(2) shall not be used to circumvent any safety and health requirements.

(5) The *occupancies* listed in Table 1.2.1.1. are exempt from compliance with 2010 ANSI/ASHRAE/IES 90.1, 1997 MNECB and 2011 NECB. (Note: The reference to the 1997 MNECB is revoked on January 1, 2018. See Minister's Ruling MR-16-S-27.)

Table 1.2.1.1.
Occupancies Exempt from Compliance with 2010 ANSI/ASHRAE/IES 90.1, 1997 MNECB and 2011 NECB⁽²⁾
 (Note: The reference to the 1997 MNECB is revoked on January 1, 2018. See Minister's Ruling MR-16-S-27.)
 Forming Part of Sentences 1.2.1.1.(1) and 1.2.1.1.(5)

GROUP A, DIVISION 4	GROUP F, DIVISION 1	GROUP F, DIVISION 2	GROUP F, DIVISION 3
Amusement Park Structures (not elsewhere classified) Bleachers Grandstands Reviewing Stands Stadia	Bulk Plants for Flammable Liquids Bulk Storage Warehouses for Hazardous Substances Cereal Mills Chemical Manufacturing or Processing Plants Distilleries Dry Cleaning Plants Feed Mills Flour Mills Grain Elevators Lacquer Factories Paint, Varnish and Pyroxylin Product Factories Rubber Processing Plants Spray Painting Operations Waste Paper Processing Plants	Dry Cleaning Establishments not using flammable or explosive solvents or cleaners Electrical Substations Helicopter Landing Areas on Roofs Laundries, except self-service Planing Mills Printing Plants Repair Garages Woodworking Factories	Creameries Power Plants Open-air Parking Garages Pumping Stations
GROUP C Part 9 Buildings ⁽¹⁾ Camps for Housing Workers (Part 3 and 9 Buildings) Recreational Camps			
Column 1	2	3	4

Notes to Table 1.2.1.1.:

- (1) Part 9 *buildings* are exempt from compliance with 2010 ANSI/ASHRAE/IES 90.1, 1997 MNECB or 2011 NECB where the energy efficiency design conforms to Division 4 of this Supplementary Standard. (Note: The reference to the 1997 MNECB is revoked on January 1, 2018. See Minister's Ruling MR-16-S-27.)
- (2) The list is not intended to be exhaustive and other exemptions may be made in accordance with Article 1.2.1.1.

Section 1.3. Climatic Zones

1.3.1. Climatic Zone Numbers

1.3.1.1. Determination of Climatic Zone Numbers

(1) Except as permitted in Sentence (2), the climatic zone number of a location shall be determined in accordance with Table 1.3.1.1. based on the corresponding heating degree-days (HDD) for locations found in Table 1.2 of MMAH Supplementary Standard SB-1, "Climatic and Seismic Data".

(2) For locations not listed in Table 1.2 of MMAH Supplementary Standard SB-1, "Climatic and Seismic Data", the heating degree-days and climatic data of the climatologically closest location is permitted to be used.

Table 1.3.1.1.
Climatic Zone Numbers for Ontario
Forming Part of Sentence 1.3.1.1.(1)
(This Table is to be used in conjunction with Tables SB 5.5-5 to SB 5.5-7)

Climatic Zone Number	Thermal Criteria
Zone 5	$\text{HDD18} < 4000^{\circ}\text{C}$
Zone 6	$4000^{\circ}\text{C} \leq \text{HDD18} < 5000^{\circ}\text{C}$
Zone 7	$\text{HDD18} \geq 5000^{\circ}\text{C}$
Column 1	2

Chapter 2

Additional Requirements to 2010 ANSI/ASHRAE/IES 90.1

Section 1.1. Changes and Additional Requirements

1.1.1. Changes and Additional Requirements to 2010 ANSI/ASHRAE/IES 90.1

1.1.1.1. Application of Chapter 2

- (1) Where compliance with energy efficiency requirements is achieved in accordance with Clause 1.1.2.1.(1)(c) of Chapter 1, energy efficiency of the *building* is required to conform to Chapter 2 of this Division.
- (2) Where compliance with energy efficiency requirements is achieved in accordance with Clause 1.1.2.1.(1)(b) of Chapter 1, energy efficiency of the *building* is permitted to conform to Chapter 2 or parts of Chapter 2 of this Division in lieu of corresponding requirements in 2010 ANSI/ASHRAE/IES 90.1.

1.1.1.2. Section 4 “Administration and Compliance” of 2010 ANSI/ASHRAE/IES 90.1

- (1) Sections 4.2.1.1 to 4.2.1.3 of 2010 ANSI/ASHRAE/IES 90.1 are replaced with the following:

4.2.1.1 New Buildings. New buildings and additions to existing buildings shall comply with provisions of either Sections 5 to 10 or Section 11.

4.2.1.2 Reserved.

4.2.1.3 Existing Buildings. Change of use of existing buildings shall conform to Part 10 of Division B of the Building Code and renovation of existing buildings shall conform to Part 11 of Division B of the Building Code.

1.1.1.3. Climatic Zones

- (1) Climatic zone numbers shall be determined in accordance with Section 1.3. of Chapter 1.

1.1.1.4. Section 5 “Building Envelope” of 2010 ANSI/ASHRAE/IES 90.1

- (1) Section 5.4.3.1.A shall be added to Section 5.4.3 “Air Leakage” of 2010 ANSI/ASHRAE/IES 90.1.

5.4.3.1.A Air Barrier Materials, Assemblies and Systems

- (1) The air barrier materials, assemblies and systems that are in conformance with Part 5 of Division B of the Building Code shall be deemed to be in compliance with Section 5.4.3.1.3 and Section 5.4.3.2.
- (2) Sections 5.5.1 and 5.5.2 shall be replaced with Sections 5.5.1.(1) through 5.5.1.(7) and Sections 5.5.3.5.1, 5.5.3.5.2, 5.5.3.7, and 5.5.3.8 shall be added to Section 5.5 of 2010 ANSI/ASHRAE/IES 90.1.

5.5.1 Exterior Building Envelope

- (1) Where electric space heating is used, the building envelope shall comply with the requirements of Table SB 5.5-7 of this Supplementary Standard, regardless of its climatic location.
- (2) For the purpose of Sentence (1), any reference to Tables 5.5-5 through 5.5-7 of 2010 ANSI/ASHRAE/IES 90.1 shall be deemed to be a reference to Tables SB 5.5-5 to SB 5.5-7 of this Supplementary Standard.
- (3) Tables SB 5.5-5 to SB 5.5-7 shall supersede the requirements of Tables 5.5-5 to 5.5-7 of 2010 ANSI/ASHRAE/IES 90.1.
- (4) Tables 5.5-1 to 5.5-8 of 2010 ANSI/ASHRAE/IES 90.1 shall not be used.
- (5) For a conditioned space, the exterior building envelope shall comply with either the “nonresidential” or “residential” requirements in Tables SB 5.5-5 through SB 5.5-7 of this Supplementary Standard for the appropriate climate.
- (6) If a building contains any semiheated space or unconditioned space, then the semi-exterior building envelope shall comply with the requirements for semiheated space in Tables SB 5.5-5 through SB 5.5-7 of this Supplementary Standard for the appropriate climate.
- (7) Notwithstanding the requirements of Tables SB 5.5-5 to SB 5.5-7, exposed frame floors need not be insulated to more than
- (a) RSI of 6.69 (R38) where the framing depth is more than 254 mm (10 in.), and
 - (b) RSI of 5.28 (R30) where the framing depth is 254 mm (10 in.) or less.

5.5.2 Reserved

5.5.3.5.1 Slabs. Insulation continuity shall be maintained in the design of slab edge insulation systems. Continuity shall be maintained from the wall insulation through the slab/wall/footing intersection to the body of the slab edge insulation. Several representative configurations are illustrated in Figure 5-1.

5.5.3.5.2 Where insulative continuity is impossible because of structural constraints, a minimum overlapping of insulation is acceptable. The insulation must overlap by a distance equal to (or greater than) four times the minimum insulation separation, as shown in Figure 5-2.

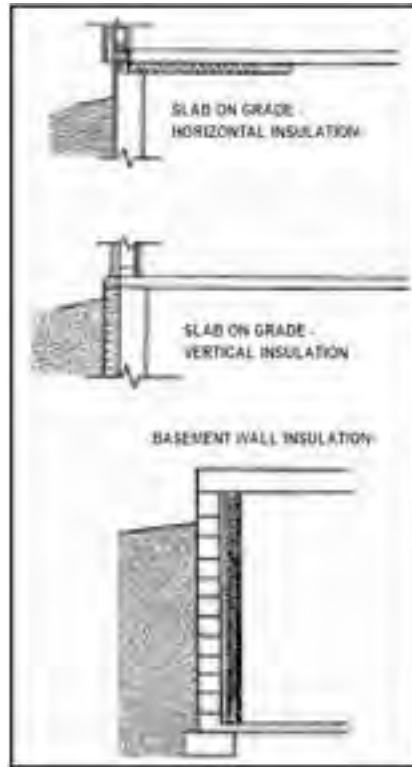


Figure 5-1
Continuity of Insulation on or Below Grade

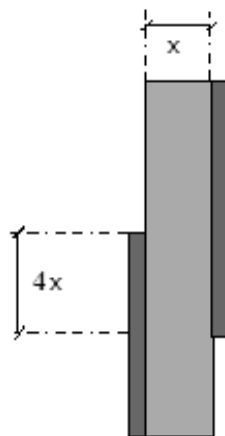


Figure 5-2
Minimum Permissible Insulation Overlap

5.5.3.7 For the purposes of Section 5, the effects of thermal bridging are waived for:

- (a) intermediate structural connections of continuous steel shelf angles (or similar structural element) used to support the building facade provided there is a thermal break between the remaining contact surface of the supporting element and the building structure. This provision is intended to substantially reduce thermal bridging effects caused by the continuous bearing between structural elements supporting building facade and the building frame (ie. steel shelf angle attached to perimeter floor slab to support brick veneer), or
- (b) structural connections of load bearing elements where a thermal break cannot be achieved.

5.5.3.8 In addition to the exceptions permitted above, the effects of thermal bridging are also waived for:

- (a) exposed structural projections of buildings where the total cross-sectional area of the exposed element does not exceed 2% of the exterior building envelope area and the cross-sectional area of the exposed structural element is measured where it penetrates the insulation component of the building envelope. (For example, if the total cross-sectional area of cantilevered concrete balconies and other projections penetrating the insulation component of the building envelope does not exceed 2% of the exterior building envelope area, their thermal bridging effects need not be taken into account)
- (b) ties in masonry construction,
- (c) flashing, and
- (d) top exposed portion of foundation walls provided the exposure does not exceed 200 mm measured from the top of the foundation wall to the top of exterior wall insulation which meets the minimum insulation RSI-Value for wall below grade stipulated in the appropriate Tables. (See Figure 5-3)

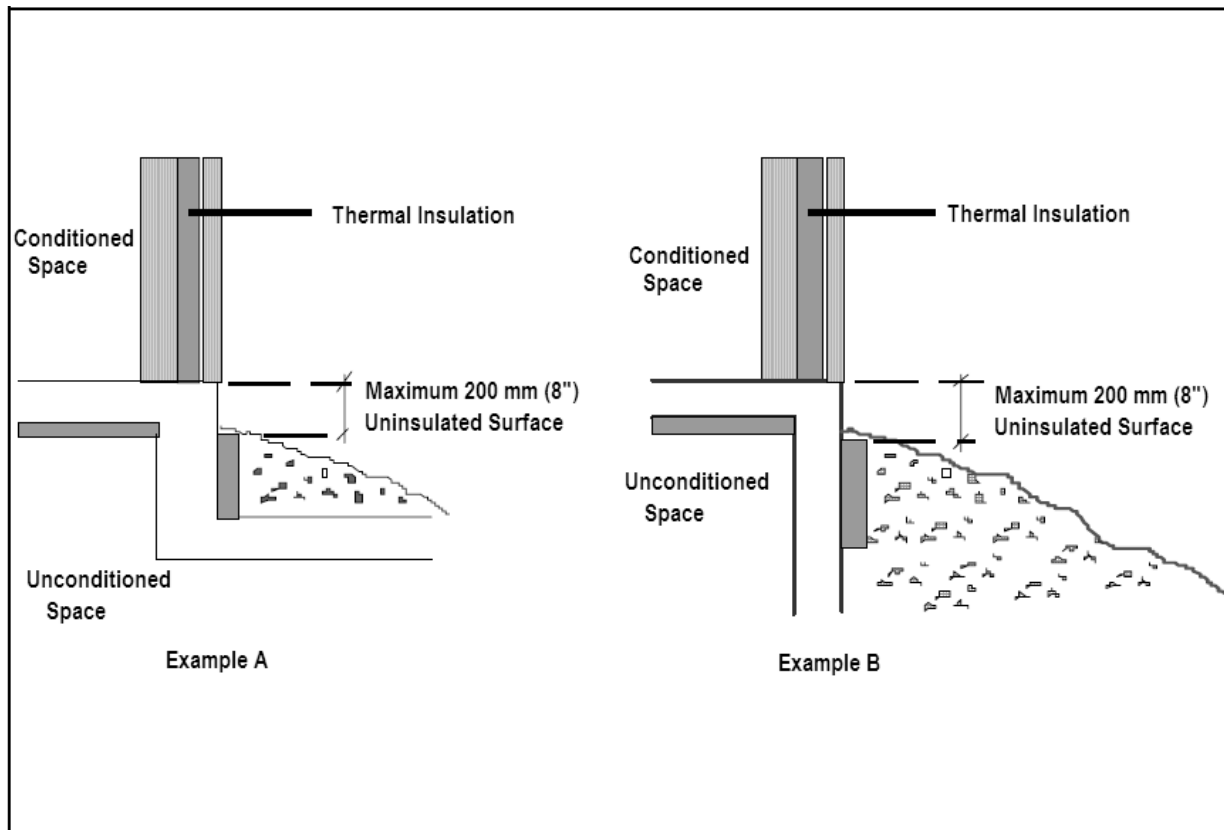


Figure 5-3
Maximum Uninsulated Surface of Foundation Wall

- (3) Section 5.5.4.5 shall only be applicable where the main entrance is located on the south orientation and the south oriented wall area is larger than west oriented wall area, and where the south oriented wall area is larger than east oriented wall area. (See Appendix A.)
- (4) The *building* envelope trade-off option in Section 5.6 of 2010 ANSI/ASHRAE/IES 90.1 shall not apply unless the procedure incorporates the modifications made to 2010 ANSI/ASHRAE/IES 90.1 through this Chapter.
- (5) Section 5.8.2.4.A shall be added to Section 5.4.3 “Air Leakage” of 2010 ANSI/ASHRAE/IES 90.1.

5.8.2.4.A Alternative Standards to determine U-factor

- (1) U-factors are permitted to be determined in accordance with CAN/CSA-A440.2, “Fenestration Energy Performance.”

TABLE SB 5.5-5 (See Appendix A.)
(Supersedes Table 5.5-5 in 2010 ANSI/ASHRAE/IES 90.1)
Building Envelope Requirements for Climate Zone 5 (A, B, C) (SI)

Opaque Elements	Nonresidential		Residential		Semiheated	
	Assembly	Insulation ^d	Assembly	Insulation ^d	Assembly	Insulation ^d
	Max. U	Min. RSI-Value	Max. U	Min. RSI-Value	Max. U	Min. RSI-Value
Roofs						
Insulation Entirely above Deck	U-0.22	4.4 ci	U-0.22	4.4 ci	U-0.53	1.8 ci
Metal Building	U-0.20	3.3 + 1.9 Ls	U-0.20	3.3 + 1.9 Ls	U-0.39	2.3 + 3.3
Attic and Other	U-0.12	8.6	U-0.12	8.6	U-0.19	5.3
Walls, Above Grade						
Mass	U-0.45	2.3 ci	U-0.40	2.7 ci	U-0.70	1.3 ci
Metal Building	U-0.30	2.3 + 2.3 ci	U-0.30	2.3 + 2.3 ci	U-0.45	2.3 + 1.1 ci
Steel Framed	U-0.31	2.3 + 1.8 ci	U-0.31	2.3 + 1.8 ci	U-0.48	2.3 + 0.7 ci
Wood Framed and Other	U-0.29	2.3 + 1.3 ci	U-0.26	2.3 + 1.8 ci	U-0.36	2.3 + 0.7 ci
Wall, Below Grade						
Below Grade Wall	C-0.52	1.8 ci	C-0.52	1.8 ci	C-0.68	1.3 ci
Floors						
Mass	U-0.36	2.2 ci	U-0.32	2.6 ci	U-0.61	1.1 ci
Steel Joist ^c	U-0.18	6.7	U-0.18	6.7	U-0.21	5.3
Wood Framed and Other ^c	U-0.15	5.3 + 1.3 ci	U-0.15	5.3 + 1.3 ci	U-0.19	5.3
Slab-On-Grade Floors						
Unheated	F-0.93	1.8 for 600 mm	F-0.90	2.6 for 600 mm	F-0.93	1.8 for 600 mm
Heated	F-0.76	2.6 for 900 mm + 0.9 ci below	F-0.76	2.6 for 900 mm + 0.9 ci below	F-1.56	1.8 for 600 mm
Opaque Doors						
Swinging	U-2.27		U-2.27		U-3.41	
Non-Swinging	U-2.27		U-2.27		U-2.84	
Fenestration	Assembly	Assembly	Assembly	Assembly	Assembly	Assembly
	Max. U	Max. SHGC	Max. U	Max. SHGC	Max. U	Max. SHGC
Vertical Fenestration, 0% - 40% of Wall						
Nonmetal framing: all ^a	U-1.42	0.35	U-1.42	0.40	U-3.12	NR
Metal framing: curtainwall / storefront ^b	U-1.99		U-1.99		U-3.41	
Metal framing: entrance door ^b	U-3.97		U-3.97		U-4.54	
Metal framing: all other ^b	U-2.56		U-2.56		U-3.69	
Skylight with Curb, Glass, % of Roof						
0% - 5.0%	U-3.80	0.36	U-3.80	0.36	U-11.24	NR
Skylight with Curb, Plastic, % of Roof						
0% - 5.0%	U-3.92	0.34	U-3.92	0.34	U-10.79	NR
Skylight without Curb, All, % of Roof						
0% - 5.0%	U-2.56	0.36	U-2.56	0.36	U-7.72	NR

Reproduced from ANSI/ASHRAE/USGBC/IES Standard 189.1-2009 with permission from ASHRAE.

The following definitions apply: ci = continuous insulation, Ls = liner system, NR = no (insulation) requirement.

a Nonmetal framing includes framing materials other than metal with or without metal reinforcing or cladding.

b Metal framing includes metal framing with or without thermal break. The all other subcategory includes operable windows, fixed windows, and non-entrance doors.

c See Section 5.5.1.(7) under Sentence 1.1.1.3.(2) of Chapter 2 of this Division.

d Alternative combinations of insulation RSI-values are permitted provided the combinations are designed in accordance with "Normative Appendix A" of 2010 ANSI/ASHRAE/IES 90.1.

TABLE SB 5.5-6 (See Appendix A.)
(Supersedes Table 5.5-6 in 2010 ANSI/ASHRAE/IES 90.1)
Building Envelope Requirements for Climate Zone 6 (A, B) (SI)

Opaque Elements	Nonresidential		Residential		Semiheated	
	Assembly	Insulation ^d	Assembly	Insulation ^d	Assembly	Insulation ^d
	Max. U	Min. RSI-Value	Max. U	Min. RSI-Value	Max. U	Min. RSI-Value
Roofs						
Insulation Entirely above Deck	U-0.18	5.3 ci	U-0.18	5.3 ci	U-0.36	2.6 ci
Metal Building	U-0.18	4.4 + 1.9 Ls	U-0.18	4.4 + 1.9 Ls	U-0.39	2.3 + 3.3
Attic and Other	U-0.12	8.6	U-0.12	8.6	U-0.15	6.7
Walls, Above Grade						
Mass	U-0.40	2.7 ci	U-0.34	3.5 ci	U-0.59	1.7 ci
Metal Building	U-0.30	2.3 + 2.3 ci	U-0.30	2.3 + 2.3 ci	U-0.45	2.3 + 1.1 ci
Steel Framed	U-0.31	2.3 + 1.8 ci	U-0.31	2.3 + 1.8 ci	U-0.48	2.3 + 0.7 ci
Wood Framed and Other	U-0.26	2.3 + 1.8 ci	U-0.26	2.3 + 1.8 ci	U-0.36	2.3 + 0.7 ci
Wall, Below Grade						
Below Grade Wall	C-0.52	1.8 ci	C-0.52	1.8 ci	C-0.68	1.3 ci
Floors						
Mass	U-0.32	2.6 ci	U-0.29	2.9 ci	U-0.61	1.1 ci
Steel Joist ^c	U-0.18	6.7	U-0.13	6.7 + 2.2 ci	U-0.21	5.3
Wood Framed and Other ^c	U-0.15	5.3 + 1.3 ci	U-0.15	5.3 + 1.3 ci	U-0.19	5.3
Slab-On-Grade Floors						
Unheated	F-0.90	2.6 for 600 mm	F-0.88	3.5 for 600 mm	F-0.93	1.8 for 600 mm
Heated	F-0.76	2.6 for 900 mm + 0.9 ci below	F-0.76	2.6 for 900 mm + 0.9 ci below	F-1.56	1.8 for 600 mm
Opaque Doors						
Swinging	U-2.27		U-2.27		U-3.41	
Non-Swinging	U-2.27		U-2.27		U-2.84	
Fenestration						
	Assembly	Assembly	Assembly	Assembly	Assembly	Assembly
	Max. U	Max. SHGC	Max. U	Max. SHGC	Max. U	Max. SHGC
Vertical Fenestration, 0% - 40% of Wall						
Nonmetal framing: all ^a	U-1.42	0.40	U-1.42	0.40	U-2.56	NR
Metal framing: curtainwall / storefront ^b	U-1.99		U-1.99		U-2.84	
Metal framing: entrance door ^b	U-3.97		U-3.97		U-4.54	
Metal framing: all other ^b	U-2.56		U-2.56		U-3.12	
Skylight with Curb, Glass, % of Roof						
0% - 5.0%	U-3.80	0.46	U-3.80	0.46	U-11.24	NR
Skylight with Curb, Plastic, % of Roof						
0% - 5.0%	U-3.92	0.49	U-3.92	0.49	U-10.79	NR
Skylight without Curb, All, % of Roof						
0% - 5.0%	U-2.56	0.46	U-2.56	0.39	U-7.72	NR

Reproduced from ANSI/ASHRAE/USGBC/IES Standard 189.1-2009 with permission from ASHRAE.

The following definitions apply: ci = continuous insulation, Ls = liner system, NR = no (insulation) requirement.

a Nonmetal framing includes framing materials other than metal with or without metal reinforcing or cladding.

b Metal framing includes metal framing with or without thermal break. The all other subcategory includes operable windows, fixed windows, and non-entrance doors.

c See Section 5.5.1.(7) under Sentence 1.1.1.3.(2) of Chapter 2 of this Division.

d Alternative combinations of insulation RSI-values are permitted provided the combinations are designed in accordance with "Normative Appendix A" of 2010 ANSI/ASHRAE/IES 90.1.

TABLE SB 5.5-7 (See Appendix A.)
(Supersedes Table 5.5-7 in 2010 ANSI/ASHRAE/IES 90.1)
Building Envelope Requirements for Climate Zone 7 (SI)

Opaque Elements	Nonresidential		Residential		Semiheated	
	Assembly	Insulation ^d	Assembly	Insulation ^d	Assembly	Insulation ^d
	Max. U	Min. RSI-Value	Max. U	Min. RSI-Value	Max. U	Min. RSI-Value
Roofs						
Insulation Entirely above Deck	U-0.16	6.2 ci	U-0.16	6.2 ci	U-0.36	2.6 ci
Metal Building	U-0.16	5.3 + 1.9 Ls	U-0.16	5.3 + 1.9 Ls	U-0.39	2.3 + 3.3
Attic and Other	U-0.10	10.6	U-0.10	10.6	U-0.15	6.7
Walls, Above Grade						
Mass	U-0.34	3.5 ci	U-0.34	3.5 ci	U-0.51	2.0 ci
Metal Building	U-0.30	2.3 + 2.3 ci	U-0.22	2.3 + 3.4 ci	U-0.45	2.3 + 1.1 ci
Steel Framed	U-0.31	2.3 + 1.8 ci	U-0.21	2.3 + 3.3 ci	U-0.48	2.3 + 0.7 ci
Wood Framed and Other	U-0.26	2.3 + 1.8 ci	U-0.26	2.3 + 1.8 ci	U-0.36	2.3 + 0.7 ci
Wall, Below Grade						
Below Grade Wall	C-0.52	1.8 ci	C-0.42	2.2 ci	C-0.68	1.3 ci
Floors						
Mass	U-0.25	3.5 ci	U-0.25	3.5 ci	U-0.50	1.5 ci
Steel Joist ^c	U-0.18	6.7	U-0.13	6.7 + 2.2 ci	U-0.21	5.3
Wood Framed and Other ^c	U-0.15	5.3 + 1.3 ci	U-0.15	5.3 + 1.3 ci	U-0.19	5.3
Slab-On-Grade Floors						
Unheated	F-0.52	2.6 for 600 mm + 0.9 ci below	F-0.52	2.6 for 600 mm + 0.9 ci below	F-0.93	1.8 for 600 mm
Heated	F-0.65	3.5 for 900 mm + 0.9 ci below	F-0.65	3.5 for 900 mm + 0.9 ci below	F-1.19	3.5 for 1200 mm
Opaque Doors						
Swinging	U-2.27		U-2.27		U-3.41	
Non-Swinging	U-2.27		U-2.27		U-2.84	
Fenestration	Assembly	Assembly	Assembly	Assembly	Assembly	Assembly
	Max. U	Max. SHGC	Max. U	Max. SHGC	Max. U	Max. SHGC
Vertical Fenestration, 0% - 40% of Wall						
Nonmetal framing: all ^a	U-1.42	0.45	U-1.42	NR	U-2.56	NR
Metal framing: curtainwall / storefront ^b	U-1.70		U-1.70			
Metal framing: entrance door ^b	U-3.97		U-3.97			
Metal framing: all other ^b	U-1.99		U-1.99			
Skylight with Curb, Glass, % of Roof						
0% - 5.0%	U-3.80	0.46	U-3.80	0.46	U-11.24	NR
Skylight with Curb, Plastic, % of Roof						
0% - 5.0%	U-3.92	0.50	U-3.92	0.50	U-10.79	NR
Skylight without Curb, All, % of Roof						
0% - 5.0%	U-2.56	0.46	U-2.56	0.46	U-7.72	NR

Reproduced from ANSI/ASHRAE/USGBC/IES Standard 189.1-2009 with permission from ASHRAE.

The following definitions apply: ci = continuous insulation, Ls = liner system, NR = no (insulation) requirement.

^a Nonmetal framing includes framing materials other than metal with or without metal reinforcing or cladding.

^b Metal framing includes metal framing with or without thermal break. The all other subcategory includes operable windows, fixed windows, and non-entrance doors.

^c See Section 5.5.1.(7) under Sentence 1.1.1.3.(2) of Chapter 2 of this Division.

^d Alternative combinations of insulation RSI-values are permitted provided the combinations are designed in accordance with "Normative Appendix A" of 2010 ANSI/ASHRAE/IES 90.1.

TABLE SB 5.5-5 (See Appendix A.)
(Supersedes Table 5.5-5 in 2010 ANSI/ASHRAE/IES 90.1)
Building Envelope Requirements for Climate Zone 5 (A, B, C) (I-P)

Opaque Elements	Nonresidential		Residential		Semiheated	
	Assembly	Insulation ^d	Assembly	Insulation ^d	Assembly	Insulation ^d
	Max. U	Min. R-Value	Max. U	Min. R-Value	Max. U	Min. R-Value
Roofs						
Insulation Entirely above Deck	U-0.039	R-25 ci	U-0.039	R-25 ci	U-0.093	R-10 ci
Metal Building	U-0.035	R-19 + R-11 Ls	U-0.035	R-19 + R-11 Ls	U-0.068	R-13 + R- 19
Attic and Other	U-0.021	R-49	U-0.021	R-49	U-0.034	R-30
Walls, Above Grade						
Mass	U-0.080	R-13.3 ci	U-0.071	R-15.2 ci	U-0.123	R-7.6 ci
Metal Building	U-0.052	R-13 + R-13 ci	U-0.052	R-13 + R-13 ci	U-0.079	R-13 + R-6.5 ci
Steel Framed	U-0.055	R-13 + R-10 ci	U-0.055	R-13 + R-10 ci	U-0.084	R-13 + R-3.8 ci
Wood Framed and Other	U-0.051	R-13 + R-7.5 ci	U-0.045	R-13 + R-10 ci	U-0.064	R-13 + R-3.8 ci
Wall, Below Grade						
Below Grade Wall	C-0.092	R-10 ci	C-0.092	R-10 ci	C-0.119	R-7.5 ci
Floors						
Mass	U-0.064	R-12.5 ci	U-0.057	R-14.6 ci	U-0.107	R-6.3 ci
Steel Joist ^c	U-0.032	R-38	U-0.032	R-38	U-0.038	R-30
Wood Framed and Other ^c	U-0.026	R-30 + R-7.5 ci	U-0.026	R-30 + R-7.5 ci	U-0.033	R-30
Slab-On-Grade Floors						
Unheated	F-0.540	R-10 for 24 in.	F-0.520	R-15 for 24 in.	F-0.540	R-10 for 24 in.
Heated	F-0.440	R-15 for 36 in. + R-5 ci below	F-0.440	R-15 for 36 in. + R-5 ci below	F-0.900	R-10 for 24 in.
Opaque Doors						
Swinging	U-0.400		U-0.400		U-0.600	
Non-Swinging	U-0.400		U-0.400		U-0.500	
Fenestration						
	Assembly	Assembly	Assembly	Assembly	Assembly	Assembly
	Max. U	Max. SHGC	Max. U	Max. SHGC	Max. U	Max. SHGC
Vertical Fenestration, 0% - 40% of Wall						
Nonmetal framing: all ^a	U-0.25	0.35	U-0.25	0.40	U-0.55	NR
Metal framing: curtainwall / storefront ^b	U-0.35		U-0.35			
Metal framing: entrance door ^b	U-0.70		U-0.70			
Metal framing: all other ^b	U-0.45		U-0.45			
Skylight with Curb, Glass, % of Roof						
0% - 5.0%	U-0.67	0.36	U-0.67	0.36	U-1.98	NR
Skylight with Curb, Plastic, % of Roof						
0% - 5.0%	U-0.69	0.34	U-0.69	0.34	U-1.90	NR
Skylight without Curb, All, % of Roof						
0% - 5.0%	U-0.45	0.36	U-0.45	0.36	U-1.36	NR

Reproduced from ANSI/ASHRAE/USGBC/IES Standard 189.1-2009 with permission from ASHRAE.

The following definitions apply: ci = continuous insulation, Ls = liner system, NR = no (insulation) requirement.

a Nonmetal framing includes framing materials other than metal with or without metal reinforcing or cladding.

b Metal framing includes metal framing with or without thermal break. The all other subcategory includes operable windows, fixed windows, and non-entrance doors.

c See Section 5.5.1.(7) under Sentence 1.1.1.3.(2) of Chapter 2 of this Division.

d Alternative combinations of insulation R-values are permitted provided the combinations are designed in accordance with "Normative Appendix A" of 2010 ANSI/ASHRAE/IES 90.1.

TABLE SB 5.5-6 (See Appendix A.)
(Supersedes Table 5.5-6 in 2010 ANSI/ASHRAE/IES 90.1)
Building Envelope Requirements for Climate Zone 6 (A, B) (I-P)

Opaque Elements	Nonresidential		Residential		Semiheated	
	Assembly	Insulation ^d	Assembly	Insulation ^d	Assembly	Insulation ^d
	Max. U	Min. R-Value	Max. U	Min. R-Value	Max. U	Min. R-Value
Roofs						
Insulation Entirely above Deck	U-0.032	R-30 ci	U-0.032	R-30 ci	U-0.063	R-15 ci
Metal Building	U-0.031	R-25 + R-11 Ls	U-0.031	R-25 + R-11 Ls	U-0.068	R-13 + R-19
Attic and Other	U-0.021	R-49	U-0.021	R-49	U-0.027	R-38
Walls, Above Grade						
Mass	U-0.071	R-15.2 ci	U-0.060	R-20 ci	U-0.104	R-9.5 ci
Metal Building	U-0.052	R-13 + R-13 ci	U-0.052	R-13 + R-13 ci	U-0.079	R-13 + R-6.5 ci
Steel Framed	U-0.055	R-13 + R-10 ci	U-0.055	R-13 + R-10 ci	U-0.084	R-13 + R-3.8 ci
Wood Framed and Other	U-0.045	R-13 + R-10 ci	U-0.045	R-13 + R-10 ci	U-0.064	R-13 + R-3.8 ci
Wall, Below Grade						
Below Grade Wall	C-0.092	R-10 ci	C-0.092	R-10 ci	C-0.119	R-7.5 ci
Floors						
Mass	U-0.057	R-14.6 ci	U-0.051	R-16.7 ci	U-0.107	R-6.3 ci
Steel Joist ^c	U-0.032	R-38	U-0.023	R-38 + R-12.5 ci	U-0.038	R-30
Wood Framed and Other ^c	U-0.026	R-30 + R-7.5 ci	U-0.026	R-30 + R-7.5 ci	U-0.033	R-30
Slab-On-Grade Floors						
Unheated	F-0.520	R-15 for 24 in.	F-0.510	R-20 for 24 in.	F-0.540	R-10 for 24 in.
Heated	F-0.440	R-15 for 36 in. + R-5 ci below	F-0.440	R-15 for 36 in. + R-5 ci below	F-0.900	R-10 for 24 in.
Opaque Doors						
Swinging	U-0.400		U-0.400		U-0.600	
Non-Swinging	U-0.400		U-0.400		U-0.500	
Fenestration	Assembly	Assembly	Assembly	Assembly	Assembly	Assembly
	Max. U	Max. SHGC	Max. U	Max. SHGC	Max. U	Max. SHGC
Vertical Fenestration, 0% - 40% of Wall						
Nonmetal framing: all ^a	U-0.25	0.40	U-0.25	0.40	U-0.45	NR
Metal framing: curtainwall / storefront ^b	U-0.35		U-0.35			
Metal framing: entrance door ^b	U-0.70		U-0.70			
Metal framing: all other ^b	U-0.45		U-0.45			
Skylight with Curb, Glass, % of Roof						
0% - 5.0%	U-0.67	0.46	U-0.67	0.46	U-1.98	NR
Skylight with Curb, Plastic, % of Roof						
0% - 5.0%	U-0.69	0.49	U-0.69	0.49	U-1.90	NR
Skylight without Curb, All, % of Roof						
0% - 5.0%	U-0.45	0.46	U-0.45	0.39	U-1.36	NR

Reproduced from ANSI/ASHRAE/USGBC/IES Standard 189.1-2009 with permission from ASHRAE.

The following definitions apply: ci = continuous insulation, Ls = liner system, NR = no (insulation) requirement.

a Nonmetal framing includes framing materials other than metal with or without metal reinforcing or cladding.

b Metal framing includes metal framing with or without thermal break. The all other subcategory includes operable windows, fixed windows, and non-entrance doors.

c See Section 5.5.1.(7) under Sentence 1.1.1.3.(2) of Chapter 2 of this Division.

d Alternative combinations of insulation R-values are permitted provided the combinations are designed in accordance with "Normative Appendix A" of 2010 ANSI/ASHRAE/IES 90.1.

**TABLE SB 5.5-7 (See Appendix A.)
(Supersedes Table 5.5-7 in 2010 ANSI/ASHRAE/IES 90.1)
Building Envelope Requirements for Climate Zone 7 (I-P)**

Opaque Elements	Nonresidential		Residential		Semiheated	
	Assembly	Insulation ^d	Assembly	Insulation ^d	Assembly	Insulation ^d
	Max. U	Min. R-Value	Max. U	Min. R-Value	Max. U	Min. R-Value
Roofs						
Insulation Entirely above Deck	U-0.028	R-35 ci	U-0.028	R-35 ci	U-0.063	R-15 ci
Metal Building	U-0.029	R-30 + R-11 Ls	U-0.029	R-30 + R-11 Ls	U-0.068	R-13 + R-19
Attic and Other	U-0.017	R-60	U-0.017	R-60	U-0.027	R-38
Walls, Above Grade						
Mass	U-0.060	R-20 ci	U-0.060	R-20 ci	U-0.090	R-11.4 ci
Metal Building	U-0.052	R-13 + R-13 ci	U-0.039	R-13 + R-19.5 ci	U-0.079	R-13 + R-6.5 ci
Steel Framed	U-0.055	R-13 + R-10 ci	U-0.037	R-13 + R-18.8 ci	U-0.084	R-13 + R-3.8 ci
Wood Framed and Other	U-0.045	R-13 + R-10 ci	U-0.045	R-13 + R-10 ci	U-0.064	R-13 + R-3.8 ci
Wall, Below Grade						
Below Grade Wall	C-0.092	R-10 ci	C-0.075	R-12.5 ci	C-0.119	R-7.5 ci
Floors						
Mass	U-0.043	R-20 ci	U-0.043	R-20 ci	U-0.087	R-8.3 ci
Steel Joist ^c	U-0.032	R-38	U-0.023	R-38 + R-12.5 ci	U-0.038	R-30
Wood Framed and Other ^c	U-0.026	R-30 + R-7.5 ci	U-0.026	R-30 + R-7.5 ci	U-0.033	R-30
Slab-On-Grade Floors						
Unheated	F-0.300	R-15 for 24 in. + R-5 ci below	F-0.300	R-15 for 24 in. + R-5 ci below	F-0.540	R-10 for 24 in.
Heated	F-0.373	R-20 for 36 in. + R-5 ci below	F-0.373	R-20 for 36 in. + R-5 ci below	F-0.688	R-20 for 48 in.
Opaque Doors						
Swinging	U-0.400		U-0.400		U-0.600	
Non-Swinging	U-0.400		U-0.400		U-0.500	
Fenestration	Assembly	Assembly	Assembly	Assembly	Assembly	Assembly
	Max. U	Max. SHGC	Max. U	Max. SHGC	Max. U	Max. SHGC
Vertical Fenestration, 0% - 40% of Wall						
Nonmetal framing: all ^a	U-0.25	0.45	U-0.25	NR	U-0.45	NR
Metal framing: curtainwall / storefront ^b	U-0.30		U-0.30			
Metal framing: entrance door ^b	U-0.70		U-0.70			
Metal framing: all other ^b	U-0.35		U-0.35			
Skylight with Curb, Glass, % of Roof						
0% - 5.0%	U-0.67	0.46	U-0.67	0.46	U-1.98	NR
Skylight with Curb, Plastic, % of Roof						
0% - 5.0%	U-0.69	0.5	U-0.69	0.5	U-1.90	NR
Skylight without Curb, All, % of Roof						
0% - 5.0%	U-0.45	0.46	U-0.45	0.46	U-1.36	NR

Reproduced from ANSI/ASHRAE/USGBC/IES Standard 189.1-2009 with permission from ASHRAE.

The following definitions apply: ci = continuous insulation, Ls = liner system, NR = no (insulation) requirement.

^a Nonmetal framing includes framing materials other than metal with or without metal reinforcing or cladding.

^b Metal framing includes metal framing with or without thermal break. The all other subcategory includes operable windows, fixed windows, and non-entrance doors.

^c See Section 5.5.1.(7) under Sentence 1.1.1.3.(2) of Chapter 2 of this Division.

^d Alternative combinations of insulation R-values are permitted provided the combinations are designed in accordance with "Normative Appendix A" of 2010 ANSI/ASHRAE/IES 90.1.

1.1.1.5. Heating Ventilation and Air-Conditioning Equipment - Test Procedures

- (1) Where *electric space heating* is used, the *building envelope* shall comply with the requirements of Table SB 5.5-7 of this Supplementary Standard, regardless of its climatic zone.
- (2) Section 6.4.1.A shall be added to Section 6 “Heating Ventilation and Air Conditioning Equipment” of 2010 ANSI/ASHRAE/IES 90.1.

6.4.1.A Testing Procedures for Minimum Equipment Efficiency

- (1) Equipment efficiencies that are tested in accordance with the test procedures listed in the 2011 NECB or in an applicable Ontario Regulation, shall be deemed to be in compliance with the test procedures given in Tables 6.8.1A to 6.8.1K.

1.1.1.6. Service Water Heating Equipment - Test Procedures

- (1) Section 7.4.2.A shall be added to Section 7 “Service Water Heating Equipment” of 2010 ANSI/ASHRAE/IES 90.1.

7.4.2.A Testing Procedures for Minimum Equipment Efficiency

- (1) Equipment efficiencies that are tested in accordance with the test procedures listed in the 2011 NECB or in an applicable Ontario Regulation, shall be deemed to be in compliance with the test procedures given in Table 7.8.
- (2) Section 7.4.5.2 of Section 7 “Service Water Heating Equipment” of 2010 ANSI/ASHRAE/IES 90.1 shall be substituted with the following Article:

7.4.5.2 Pool Covers. Heated exterior public pools and public spas shall be equipped with pool covers.

Exception. Pools deriving over 60% of their energy for heating (computed over an annual operating season) from site-recovered or site-solar energy.

1.1.1.7. Power, Lighting and Other Equipment

- (1) Automatic receptacle controls required in Section 8.4.2 of 2010 ANSI/ASHRAE/IES 90.1 shall not apply to private and open offices.
- (2) Section 9.4.1.3.(b) of 2010 ANSI/ASHRAE/IES 90.1 shall be substituted with the following:
 - 9.4.1.3.(b) Lighting shall be controlled by one or more devices that automatically reduce lighting power by a minimum of 30% when there is no activity detected within a lighting zone for no more than 30 minutes. Lighting zone for this requirement shall be no larger than 334 m² (3600 ft²).
- (3) The additional controls required in Section 9.4.1.6.(g) of 2010 ANSI/ASHRAE/IES 90.1 shall not apply to lighting installed to provide minimum illumination level required by Section 3.2.7. of Division B of the *Building Code*.
- (4) Uncovered parking areas are exempt from the requirements of Section 9.4.1.7.(c) of 2010 ANSI/ASHRAE/IES 90.1.
- (5) Section 10.4.1.A shall be added to Section 10 “Other Equipment” of 2010 ANSI/ASHRAE/IES 90.1.

10.4.1.A Standards for Electric Motors

- (1) Where the minimum efficiency of an electric motor that is within the scope of 2010 ANSI/ASHRAE/IES 90.1 is regulated by an Ontario Regulation, compliance with the requirements of Ontario Regulation shall be deemed to be compliance with the requirements of Section 10.4.1 and Tables 10.8a through 10.8c.
- (2) Where the minimum efficiency of an electric motor that is within the scope of 2010 ANSI/ASHRAE/IES 90.1 is regulated by an Ontario Regulation, the efficiency level shall be based on CSA C390, “Test Methods, Marking Requirements, and Energy Efficiency Levels for Three-Phase Induction Motors”.
- (3) Electric motors shall comply with the appropriate minimum nominal efficiency requirements of Table 10.4.1.A.(a) or Table 10.4.1.A.(b).

Table 10.4.1.A.(a)
Minimum Nominal Efficiency for Motors (Premium Efficiency 60 Hz Motors)

Rated Power	Open Motors			Enclosed Motors		
	Number of Poles			Number of Poles		
hp (kW)	2	4	6	2	4	6
	Minimum Energy Efficiency, %			Minimum Energy Efficiency, %		
1 (0.75)	77.0	85.5	82.5	77.0	85.5	82.5
1.5 (1.1)	84.0	86.5	86.5	84.0	86.5	87.5
2 (1.5)	85.5	86.5	87.5	85.5	86.5	88.5
3 (2.2)	85.5	89.5	88.5	86.5	89.5	89.5
5 (3.7)	86.5	89.5	89.5	88.5	89.5	89.5
7.5 (5.5)	88.5	91.0	91.0	89.5	91.7	91.0
10 (7.5)	89.5	91.7	91.7	90.2	91.7	91.0
15 (11)	90.2	93.0	91.7	91.0	92.4	91.7
20 (15)	91.0	93.0	92.4	91.0	93.0	91.7
25 (18.5)	91.7	93.6	93.0	91.7	93.6	93.0
30 (22)	91.7	94.1	93.6	91.7	93.6	93.0
40 (30)	92.4	94.1	94.1	92.4	94.1	94.1
50 (37)	93.0	94.5	94.1	93.0	94.5	94.1
60 (45)	93.6	95.0	94.5	93.6	95.0	94.5
75 (55)	93.6	95.0	94.5	93.6	95.4	94.5
100 (75)	93.6	95.4	95.0	94.1	95.4	95.0
125 (90)	94.1	95.4	95.0	95.0	95.4	95.0
150 (110)	94.1	95.8	95.4	95.0	95.8	95.8
200 (150)	95.0	95.8	95.4	95.4	96.2	95.8
250 (185)	95.0	95.8	95.4	95.8	96.2	95.8
300 (225)	95.4	95.8	95.4	95.8	96.2	95.8
350 (260)	95.4	95.8	95.4	95.8	96.2	95.8
400 (300)	95.8	95.8	95.8	95.8	96.2	95.8
450 (340)	95.8	96.2	96.2	95.8	96.2	95.8
500 (375)	95.8	96.2	96.2	95.8	96.2	95.8
Column 1	2	3	4	5	6	7

Table 10.4.1.A.(b)
Minimum Nominal Efficiency for Motors (Energy Efficient 60 Hz Motors)

Rated Power	Open Motors				Enclosed Motors			
	Number of Poles				Number of Poles			
hp (kW)	2	4	6	8	2	4	6	8
	Minimum Energy Efficiency, %				Minimum Energy Efficiency, %			
1 (0.75)	75.5	82.5	80.0	74.0	75.5	82.5	80.0	74.0
1.5 (1.1)	82.5	84.0	84.0	75.5	82.5	84.0	85.5	77.0
2 (1.5)	84.0	84.0	85.5	85.5	84.0	84.0	86.5	82.5
3 (2.2)	84.0	86.5	86.5	86.5	85.5	87.5	87.5	84.0
4 (3)	84.0	86.5	86.5	86.5	85.5	87.5	87.5	84.0
5 (3.7)	85.5	87.5	87.5	87.5	87.5	87.5	87.5	85.5
5.5 (4)	85.5	87.5	87.5	87.5	87.5	87.5	87.5	85.5
7.5 (5.5)	87.5	88.5	88.5	88.5	88.5	87.5	89.5	85.5
10 (7.5)	88.5	89.5	90.2	89.5	89.5	89.5	89.5	88.5
15 (11)	89.5	91.0	90.2	89.5	90.2	89.5	90.2	88.5
20 (15)	90.2	91.0	91.0	90.2	90.2	91.0	90.2	89.5
25 (18.5)	91.0	91.7	91.7	90.2	91.0	91.0	91.7	89.5
30 (22)	91.0	92.4	92.4	91.0	91.0	92.4	91.7	91.0
40 (30)	91.7	93.0	93.0	91.0	91.7	92.4	93.0	91.0
50 (37)	92.4	93.0	93.0	91.7	92.4	93.0	93.0	91.7
60 (45)	93.0	93.6	93.6	92.4	93.0	93.0	93.6	91.7
75 (55)	93.0	94.1	93.6	93.6	93.0	93.6	93.6	93.0
100 (75)	93.0	94.1	94.1	93.6	93.6	94.1	94.1	93.0
125 (90)	93.6	94.5	94.1	93.6	94.5	94.5	94.1	93.6
150 (110)	93.6	95.0	94.5	93.6	94.5	94.5	95.0	93.6
175 (132)	94.5	95.0	94.5	93.6	95.0	95.0	95.0	94.1
200 (150)	94.5	95.0	94.5	93.6	95.0	95.0	95.0	94.1
250 (185)	94.5	95.4	95.4	94.5	95.4	95.4	95.0	94.5
300 (225)	95.0	95.4	95.4		95.4	95.4	95.0	
350 (260)	95.0	95.4	95.4		95.4	95.4	95.0	
400 (300)	95.4	95.4			95.4	95.4		
450 (340)	95.8	95.8			95.4	95.4		
500 (375)	95.8	95.8			95.4	95.8		
Column 1	2	3	4	5	6	7	8	9

1.1.1.8. Energy Cost Method

- (1) Where the compliance is achieved in accordance with Sentence 1.1.2.1.(1)(b), the *building* shall be designed to reduce its annual energy use that is calculated in terms of energy units such as GJ, kWh by 5% than the level attained by conforming to 2010 ANSI/ASHRAE/IES 90.1.
- (2) Section 11.2.1.1.(a.) of 2010 ANSI/ASHRAE/IES 90.1 shall be substituted with the following:
 - a. hour by hour and a minimum of 8760 hours per year.
- (3) Section 11.3.2.(d.) of 2010 ANSI/ASHRAE/IES 90.1 shall be substituted with the following:
 - d. For the purpose of annual energy use simulation, except as provided in (d1.), the peak outdoor air ventilation rates for the proposed and reference building shall be set to the minimum rates required by the applicable ventilation standard based on the proposed building design.
 - d1. Except where it may be required by Section 6 of 2010 ANSI/ASHRAE/IES 90.1, demand controlled and dedicated ventilation strategies need not be modeled in the reference building.
- (4) Notwithstanding Section 11.3.2.(h.), the reference building fan power may be modeled in accordance with the requirements of G3.1.2.10 of Appendix G, 2010 ANSI/ASHRAE/IES 90.1.
- (5) Notwithstanding footnotes “e” and “f” of Table 11.2.3.A, the reference building water pumps may be modeled in accordance with the requirements of G3.1.3.5 and G3.1.3.10 of Appendix G, 2010 ANSI/ASHRAE/IES 90.1.
- (6) For automatic lighting controls in addition to those required in Section 9.4.1 credit may be taken for automatically controlled systems by reducing the connected lighting power by the applicable percentages listed in Table G3.2. of Appendix G, 2010 ANSI/ASHRAE/IES 90.1.
- (7) Section 11.2.3.A.(1) shall be added to Section 11.2 “Simulation General Requirements” of 2010 ANSI/ASHRAE/IES 90.1.

11.2.3.A. Rates for Energy Supplied Back to the Grid System.

- (1) Where energy generated by an on-site renewable energy source is supplied back to the grid system, for the purpose of Section 11, Energy Cost Budget Method, the rates for the energy supplied back to the grid system shall be assumed to be equal to the rates paid for the same type of purchased energy from the grid system.

Chapter 3

Additional Requirements to the 2011 NECB

Section 1.1. Changes and Additional Requirements

1.1.1. Changes and Additional Requirements to the 2011 NECB

1.1.1.1. Application of Chapter 3

- (1) Where compliance with energy efficiency requirements is achieved in accordance with Clause 1.1.2.1.(1)(d) of Chapter 1, energy efficiency of the *building* is required to conform to Chapter 3 of this Division.
- (2) Notwithstanding Sentence 1.1.1.3.(1) of the 2011 NECB, where the requirements of the *Building Code* or the requirements of this Division are in conflict with the requirements of the 2011 NECB, the requirements of the *Building Code* and the requirements of this Division shall govern.
- (3) In the 2011 NECB, references made to the CCBFC NRCC 53301, “National Building Code of Canada” or CCBFC NRCC 53302, “National Plumbing Code of Canada” are deemed to be references to corresponding provisions of the *Building Code*.

1.1.1.2. Division A, Part 1 “Compliance” of the 2011 NECB

- (1) Notwithstanding the provisions of Part 1 of Division A of the 2011 NECB, except as provided in Division 1 and Chapter 1 of Division 3 of this Supplementary Standard and except for *residential occupancies* that are within the scope of Part 9 of Division B of the *Building Code*, the 2011 NECB shall apply to all *buildings*.

1.1.1.3. Division A, Part 2 “Objectives” and Part 3 “Functional Statements” of the 2011 NECB

- (1) In addition to objectives and functional statements set out in Parts 2 and 3 of Division A of the 2011 NECB, the objectives and functional statements set out in the *Building Code* and attributed to Sentence 12.2.1.2.(2) of Division B of the *Building Code* shall also be the objectives and functional statements of the 2011 NECB.

1.1.1.4. Division B, “Acceptable Solutions” of the 2011 NECB

- (1) Except as provided in this Chapter, the energy efficiency of a *building* shall conform to all requirements of Division B “Acceptable Solutions” of the 2011 NECB and this Chapter.

1.1.1.5. Division C, “Administrative Provisions” of the 2011 NECB

(1) Division C “Administrative Provisions” of the 2011 NECB shall be substituted with the administrative provisions of the *Building Code Act, 1992* and the administrative provisions of Division C of the *Building Code*.

1.1.1.6. Enhancements to Division B, Part 3 “Building Envelope” of the 2011 NECB

(1) Where *electric space heating* is used in a *building* located in Zone 5, 6, 7A, or 7B, the *building* envelope requirements of Zone 7B of the 2011 NECB shall apply regardless of climatic zone.

(2) Sentence (4) shall be added to Article 3.2.2.3. of Division B of the 2011 NECB.

3.2.2.3. Thermal Characteristics of Fenestration

(4) The solar heat gain coefficient of fenestration shall comply with Table 3.2.2.3.A.

Table 3.2.2.3.A.
Solar Heat Gain Coefficients
 Forming Part of Sentence 3.2.2.3.(4)

Climatic Zone	Zone 5		Zone 6		Zone 7A and 7B		Zone 8	
	Residential	Others	Residential	Others	Residential	Others	Residential	Others
Vertical Fenestration, SHGC	0.40	0.35	0.40	0.40	NR	0.45	NR	NR
Skylights, SHGC	0.36	0.36	0.46	0.46	0.46	0.46	NR	NR
Column 1	2	3	4	5	6	7	8	9

Notes to Table 3.2.2.3.A.:

NR = No requirement

Division 3

Energy Efficiency Design After December 31, 2016

(Applies to construction for which a permit has been applied for after December 31, 2016)

Chapter 1 General

1.1.	General	
1.1.1.	Scope.....	37
1.1.2.	Energy Efficiency	37
1.1.3.	Chapter 2	39
1.1.4.	Chapter 3	39
1.2.	Application	
1.2.1.	Application of Articles 1.1.2.1. to 1.1.2.3.	40
1.3.	Climatic Zones	
1.3.1.	Climatic Zone Numbers	41

Chapter 2 Additional Requirements to 2013 ANSI/ASHRAE/IES Standard 90.1

1.1.	Changes and Additional Requirements	
1.1.1.	Changes and Additional Requirements to 2013 ANSI/ASHRAE/IES 90.1	43

Chapter 3 Additional Requirements to the 2015 NECB

1.1.	Changes and Additional Requirements	
1.1.1.	Changes and Additional Requirements to the 2015 NECB	65

FOREWORD

Division 3 of this Supplementary Standard contains requirements for the design and construction of buildings for which a permit has been applied for after December 31, 2016. In this updated Supplementary Standard, the existing sample compliance paths in this Division have been replaced by new compliance paths. The compliance paths are based on contemporary energy codes and standards and contain additional requirements to achieve, on average, a 13 percent improvement over the efficiency level required by Sentence 12.2.1.1.(2) of Division B of the Building Code. Division 3 contains a transition provision and revised CO₂e factors in Chapter 1 as well as the following three compliance paths based on:

1. ANSI/ASHRAE/IES Standard 90.1-2013, “Energy Standard for Buildings Except Low-Rise Residential Buildings”, and additional requirements introduced through Chapter 2,
2. ANSI/ASHRAE/USGBC/IES Standard 189.1-2014, “Standard for the Design of High-Performance Green Buildings Except Low-Rise Residential Buildings”, and
3. CCBFC NRCC 56191, “2015 National Energy Code of Canada for Buildings” and additional requirements introduced through Chapter 3.

Division 3 also describes limitations on peak electric demand and annual carbon dioxide emissions.

Division 3 outlines the modifications made to these documents which are generally enhancements to the building envelope, mechanical equipment, lighting and heat recovery provisions of 2013 ANSI/ASHRAE/IES 90.1 and the 2015 NECB. These modifications can be found in Chapters 2 and 3, respectively. Certain buildings and parts of buildings are exempted from the energy efficiency provisions in this Division.

Compliance with this Division does not necessarily ensure that the actual annual energy consumption or actual annual energy cost of a building is less than or equal to the theoretical values arrived at using the building energy cost budget method of 2013 ANSI/ASHRAE/IES 90.1 or performance method of the 2015 NECB. Factors such as weather, workmanship, depreciation of the thermal resistance of building materials, occupant/user lifestyle, building operation and maintenance impact on the actual energy consumption of a building, while simulation assumption and software used may affect the theoretical calculations.

Summary of the Contents of Division 3

Chapter 1: General

This Chapter contains the application, energy efficiency design requirements and exemptions to SB-10. It also contains climatic zones applicable to Ontario locations.

Chapter 2: Additional Requirements to 2013 ANSI/ASHRAE/IES 90.1. This Chapter contains additions and/or substitutions to 2013 ANSI/ASHRAE/IES 90.1.

Chapter 3: Additional Requirements to the 2015 NECB. This Chapter contains additions and/or substitutions to the 2015 NECB.

Recommended Resource Material: ANSI/ASHRAE/IES Standard 90.1-2013 User’s Manual.

Division 3

Chapter 1

General

Section 1.1. General

1.1.1. Scope

1.1.1.1. Scope

- (1) Except as provided in Sentence (2), this Division applies to *construction* for which a permit has been applied for after December 31, 2016.
- (2) *Construction* for which a permit is applied for on or before December 31, 2017 is permitted to conform to Division 3 as it read on December 31, 2016. (See Appendix A.)

1.1.2. Energy Efficiency Design, Carbon Dioxide Equivalents and Peak Electric Demand

1.1.2.1. Energy Efficiency Design

- (1) Except as provided in Sentence (2) and Article 1.2.1.1., the energy efficiency of all *buildings* shall be designed to achieve the energy efficiency levels attained by conforming to
 - (a) 2013 ANSI/ASHRAE/IES 90.1 and Chapter 2,
 - (b) 2015 NECB and Chapter 3, or
 - (c) Section 7 “Energy Efficiency” of 2014 ANSI/ASHRAE/USGBC/IES 189.1, excluding Sections 7.2.b, 7.4.7.3, 7.4.8 and 7.5.
- (2) Energy efficiency requirements do not apply to *buildings* or parts of *buildings* described in Article 1.2.1.1.

1.1.2.2. Carbon Dioxide Equivalents

- (1) The annual CO₂e emission level from a *building* shall be determined in accordance with good engineering practice using the CO₂e emission factors listed in Table 1.1.2.2.
- (2) The annual CO₂e emission level from a *building* required to comply with Clause 1.1.2.1.(1) (a), shall not exceed the level achieved by complying with Sections 5 to 10 of 2013 ANSI/ASHRAE/IES 90.1 and Chapter 2.
- (3) The annual CO₂e emission level from a *building* required to comply with Clause 1.1.2.1.(1) (b), shall not exceed the level achieved by complying with Sections 1 to 7 of the 2015 NECB and Chapter 3.

(4) The annual CO₂e emission level from a *building* required to comply with Clause 1.1.2.1.(1) (c), shall not exceed the level achieved by complying with Sections 7.1, 7.2.a, 7.3 and 7.4 of 2014 ANSI/ASHRAE/USGBC/IES Standard 189.1.

(5) Where the energy efficiency compliance of a *building* is achieved using the Energy Cost Budget Method of 2013 ANSI/ASHRAE/IES 90.1 and Chapter 2, or Building Energy Performance Compliance Path of the 2015 NECB and Chapter 3:

- (a) the annual design CO₂e emission level from the *building* shall be calculated, and
- (b) the annual design CO₂e emission level of the proposed building shall not exceed the annual CO₂e emission level of the corresponding baseline or reference building using the CO₂e emission factors listed in Table 1.1.2.2.

Table 1.1.2.2.
CO₂e Emission Factors
Forming Part of Sentences 1.1.2.2.(1) and (5)

Building Energy Source	Emission Factor
Stationary Sources	
Electricity (average for 2014)	0.050 kgCO ₂ e / kWh
Natural Gas	1.899 kgCO ₂ e / m ³
Propane	1.548 kgCO ₂ e / L
Heating Oil	2.755 kgCO ₂ e / L
Column 1	2

Notes to Table 1.1.2.2.:

1. Factors are expressed in units of CO₂ equivalent (CO₂e) so as to encompass the global warming effects of all relevant greenhouse gases (CO₂, CH₄, and N₂O).
2. Non-CO₂ emission components are technology dependent and vary by application; the above factors assume the most common and likely applications.
3. Electricity emission factor is an average consumption intensity factor for the year 2014; electricity factors are subject to change on an annual basis depending on the mix of generation in a particular year. Use the latest available published data.
4. Factors are expressed in their native units (e.g. kWh, m³, or litre) and conversion to other common units (e.g. kgCO₂e / GJ) is possible through calculation; a suggested list of unit conversions is available from the National Energy Board.
5. The table is not comprehensive or exhaustive and not necessarily representative of every energy source that may be encountered in a project; other factors may be used on a case-by-case basis with appropriate methodological justification.
6. Emission factors are sourced from Environment and Climate Change Canada's 2016 National Inventory Report (NIR) unless otherwise noted and values have been rounded; further information on emission factors can be found in Annex 6 of Part 2 of the 2016 NIR which can be downloaded.

1.1.2.3. Peak Electric Demand

- (1) The peak electric demand of a *building* required to comply with Clause 1.1.2.1.(1) (a), shall not exceed the level achieved by complying with Sections 5 to 10 of 2013 ANSI/ASHRAE/IES 90.1 and Chapter 2.
- (2) The peak electric demand of a *building* required to comply with Clause 1.1.2.1.(1) (b), shall not exceed the level achieved by complying with Sections 1 to 7 of the 2015 NECB and Chapter 3.
- (3) The peak electric demand of a *building* required to comply with Clause 1.1.2.1.(1) (c), shall not exceed the level achieved by complying with Sections 7.1 to 7.4.7.5 of 2014 ANSI/ASHRAE/USGBC/IES Standard 189.1.
- (4) Except as provided in Sentence (5), where the energy efficiency compliance of a *building* is achieved by using the Energy Cost Budget Method of 2013 ANSI/ASHRAE/IES 90.1 and Chapter 2, or the Building Energy Performance Compliance Path of the 2015 NECB and Chapter 3:
 - (a) the peak electric demand of a *building* shall be calculated, and
 - (b) the peak electric demand of the proposed building shall not exceed the peak electric demand of the corresponding budget or reference building.
- (5) A *building* is deemed to comply with Sentences (1) to (4), if the *building* design meets the applicable prescriptive requirements set in Article 1.1.2.1. for the energy efficiency of
 - (a) the cooling equipment, fan power limitations for cooling and ventilation systems, and interior lighting power density, if the *building's* peak electric demand occurs in summer, or
 - (b) the space and water heating equipment, fans, pumps and interior lighting power density, if the *building's* peak electric demand occurs in winter.

1.1.3. Chapter 2

1.1.3.1. Chapter 2

- (1) Chapter 2 contains additional requirements and changes to 2013 ANSI/ASHRAE/IES 90.1 and applies where compliance with energy efficiency requirements is achieved in accordance with Clause 1.1.2.1.(1)(a).

1.1.4. Chapter 3

1.1.4.1. Chapter 3

- (1) Chapter 3 contains additional requirements and changes to the 2015 NECB and applies where compliance with energy efficiency requirements is achieved in accordance with Clause 1.1.2.1.(1)(b).

Section 1.2. Application

1.2.1. Application of Articles 1.1.2.1. to 1.1.2.3.

1.2.1.1. Exceptions

- (1) The requirements of Articles 1.1.2.1. to 1.1.2.3. of this Chapter do not apply to
 - (a) a *building* or part of a *building* of *residential occupancy* that is within the scope of Part 9 of Division B of the *Building Code*,
 - (b) construction trailers, tents and *air-supported structures*,
 - (c) a *building* or part of a *building* where the environmental condition within the *building* is governed by the process, operation of the *building* or permanent openings to the outdoors or to unconditioned environments,
 - (d) a *building* or part of a *building* where it can be shown that meeting the requirements of Article 1.1.2.1. does not conserve any energy,
 - (e) equipment or processes that use energy for manufacturing, industrial and commercial purposes, and
 - (f) *occupancies* listed in Table 1.2.1.1.

Table 1.2.1.1.
Occupancies Exempt from Compliance with Articles 1.1.2.1 to 1.1.2.3.
Forming Part of Sentence 1.2.1.1.(1)

GROUP A, DIVISION 4 Amusement Park Structures (not elsewhere classified) Bleachers Grandstands Reviewing Stands Stadia	GROUP F, DIVISION 1 Bulk Plants for Flammable Liquids Bulk Storage Warehouses for Hazardous Substances Cereal Mills Chemical Manufacturing or Processing Plants Distilleries Dry Cleaning Plants Feed Mills Flour Mills Grain Elevators Lacquer Factories Paint, Varnish and Pyroxylin Product Factories Rubber Processing Plants Spray Painting Operations Waste Paper Processing Plants	GROUP F, DIVISION 2 Dry Cleaning Establishments not using flammable or explosive solvents or cleaners Electrical Substations Helicopter Landing Areas on Roofs Laundries, except self-service Planing Mills Printing Plants Repair Garages Woodworking Factories	GROUP F, DIVISION 3 Creameries Power Plants Open-air Parking Garages Pumping Stations
GROUP C Part 9 Buildings ⁽¹⁾ Camps for Housing Workers (Part 3 and 9 Buildings) Recreational Camps			
Column 1	2	3	4

Notes to Table 1.2.1.1.:

- (1) Part 9 *buildings* are exempt from compliance with Articles 1.1.2.1. to 1.1.2.3. where the energy efficiency design conforms to Division 5 of this Supplementary Standard.
- (2) The list is not intended to be exhaustive and other exemptions may be made in accordance with Article 1.2.1.1.

- (2) The following *buildings* or parts of *buildings* need not to comply with *building* envelope requirements:
- (a) any *building* space which uses energy for space conditioning at a rate less than 12 W/m² under peak conditions,
 - (b) warehouses and storage rooms where the design indoor temperature does not exceed 10°C,
 - (c) except conditioned spaces of *buildings* exposed to unheated *storage garages* and unheated storage rooms, unheated *storage garages* and unheated storage rooms, and
 - (d) where part of a single enclosed space is heated.
- (3) Where specifically noted in this Supplementary Standard or documents referenced in Sentence 12.2.1.1.(2) of Division B of the *Building Code*, certain other *buildings* or elements of *buildings* shall be exempt.

Section 1.3. Climatic Zones

1.3.1. Climatic Zone Numbers

1.3.1.1. Determination of Climatic Zone Numbers

- (1) Except as permitted in Sentence (2), the climatic zone number of a location shall be determined in accordance with Table 1.3.1.1. based on the corresponding heating degree-days (HDD) for locations found in Table 1.2 of MMAH Supplementary Standard SB-1, “Climatic and Seismic Data”.
- (2) For locations not listed in Table 1.2 of MMAH Supplementary Standard SB-1, “Climatic and Seismic Data”, the heating degree-days and climatic data of the climatologically closest location is permitted to be used.

Table 1.3.1.1.
Climatic Zone Numbers for Ontario
 Forming Part of Sentence 1.3.1.1.(1)
 (This Table is to be used in conjunction with Tables SB 5.5-5 to SB 5.5-7)

Climatic Zone Number	Thermal Criteria
Zone 5	HDD18 < 4000°C
Zone 6	4000°C ≤ HDD18 < 5000°C
Zone 7	HDD18 ≥ 5000°C
Column 1	2

Chapter 2

Additional Requirements to 2013 ANSI/ASHRAE/IES 90.1

Section 1.1. Changes and Additional Requirements

1.1.1. Changes and Additional Requirements

1.1.1.1. Application of Chapter 2

(1) Where compliance with energy efficiency requirements is achieved in accordance with Clause 1.1.2.1.(1)(a) of Chapter 1, energy efficiency of the *building* is required to conform to this Chapter.

1.1.1.2. Section 4 “Administration and Compliance” of 2013 ANSI/ASHRAE/IES 90.1

(1) Sections 4.2.1.1 to 4.2.1.3 of 2013 ANSI/ASHRAE/IES 90.1 are replaced with the following:

4.2.1.1 New Buildings. New buildings and additions to existing buildings shall comply with provisions of either Sections 5 to 10 or Section 11.

4.2.1.2 Reserved.

4.2.1.3 Existing Buildings. Change of use of existing buildings shall conform to Part 10 of Division B of the Building Code and renovation of existing buildings shall conform to Part 11 of Division B of the Building Code.

1.1.1.3. Climatic Zones

(1) Climatic zone numbers shall be determined in accordance with Section 1.3. of Chapter 1.

1.1.1.4. Section 5 “Building Envelope” of 2013 ANSI/ASHRAE/IES 90.1

(1) Section 5.4.3.1.A shall be added to Section 5.4.3 “Air Leakage” of 2013 ANSI/ASHRAE/IES 90.1.

5.4.3.1.A Air Barrier Materials, Assemblies and Systems

(1) The air barrier materials, assemblies and systems that are in conformance with Part 5 of Division B of the Building Code shall be deemed to be in compliance with Section 5.4.3.1.3 and Section 5.4.3.2.

(2) Sections 5.5.1 and 5.5.2 shall be replaced with Sections 5.5.1.(1) through 5.5.1.(7) and Sections 5.5.3.5.1, 5.5.3.5.2, 5.5.3.7, and 5.5.3.8 shall be added to Section 5.5 of 2013 ANSI/ASHRAE/IES 90.1.

5.5.1 Exterior Building Envelope

- (1) Where electric space heating is used, the building envelope shall comply with the requirements of Table SB 5.5-7 of this Supplementary Standard, regardless of its climatic location.
- (2) For the purpose of Sentence (1), any reference to Tables 5.5-5 through 5.5-7 of 2013 ANSI/ASHRAE/IES 90.1 shall be deemed to be a reference to Tables SB 5.5-5–2017 to SB 5.5-7–2017 of this Supplementary Standard.
- (3) Tables SB 5.5-5–2017 to SB 5.5-7–2017 shall supersede the requirements of Tables 5.5-5 to 5.5-7 of 2013 ANSI/ASHRAE/IES 90.1
- (4) Tables 5.5-1 to 5.5-8 of 2013 ANSI/ASHRAE/IES 90.1 shall not be used.
- (5) For a conditioned space, the exterior building envelope shall comply with either the “nonresidential” or “residential” requirements in Tables SB 5.5-5–2017 through SB 5.5-7–2017 of this Supplementary Standard for the appropriate climate.
- (6) If a building contains any semiheated space or unconditioned space, then the semi-exterior building envelope shall comply with the requirements for semiheated space in Tables SB 5.5-5–2017 through SB 5.5-7–2017 of this Supplementary Standard for the appropriate climate.
- (7) Notwithstanding the requirements of Tables SB 5.5-5–2017 to SB 5.5-7–2017, exposed frame floors, between the framing members, need not be insulated to more than
 - (a) RSI of 6.69 (R38) where the framing depth is more than 254 mm (10 in.), and
 - (b) RSI of 5.28 (R30) where the framing depth is 254 mm (10 in.) or less, and

5.5.2. Reserved

5.5.3.5.1 Slabs. Insulation continuity shall be maintained in the design of slab edge insulation systems. Continuity shall be maintained from the wall insulation through the slab/wall/footing intersection to the body of the slab edge insulation. Several representative configurations are illustrated in Figure 5-1.

5.5.3.5.2 Where insulative continuity is impossible because of structural constraints, a minimum overlapping of insulation is acceptable. The insulation must overlap by a distance equal to (or greater than) four times the minimum insulation separation, as shown in Figure 5-2.

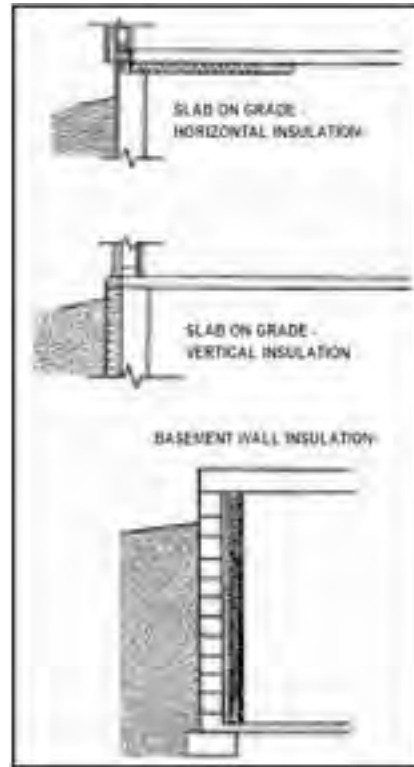


Figure 5-1
Continuity of Insulation on or Below Grade

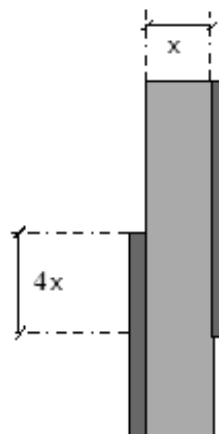


Figure 5-2
Minimum Permissible Insulation Overlap

5.5.3.7 For the purposes of Section 5, the effects of thermal bridging are waived for:

- (a) intermediate structural connections of continuous steel shelf angles (or similar structural element) used to support the building facade provided there is a thermal break between the remaining contact surface of the supporting element and the building structure. This provision is intended to substantially reduce thermal bridging effects caused by the continuous bearing between structural elements supporting building facade and the building frame (ie. steel shelf angle attached to perimeter floor slab to support brick veneer), or
- (b) structural connections of load bearing elements where a thermal break cannot be achieved.

5.5.3.8 In addition to the exceptions permitted above, the effects of thermal bridging are also waived for:

- (a) exposed structural projections of buildings where the total cross-sectional area of the exposed element does not exceed 2% of the exterior building envelope area and the cross-sectional area of the exposed structural element is measured where it penetrates the insulation component of the building envelope, (For example, if the total cross-sectional area of cantilevered concrete balconies and other projections penetrating the insulation component of the building envelope does not exceed 2% of the exterior building envelope area, their thermal bridging effects need not be taken into account)
- (b) ties in masonry construction,
- (c) flashing, and
- (d) top exposed portion of foundation walls provided the exposure does not exceed 200 mm measured from the top of the foundation wall to the top of exterior wall insulation which meets the minimum insulation RSI-Value for wall below grade stipulated in the appropriate Tables. (See Figure 5-3)

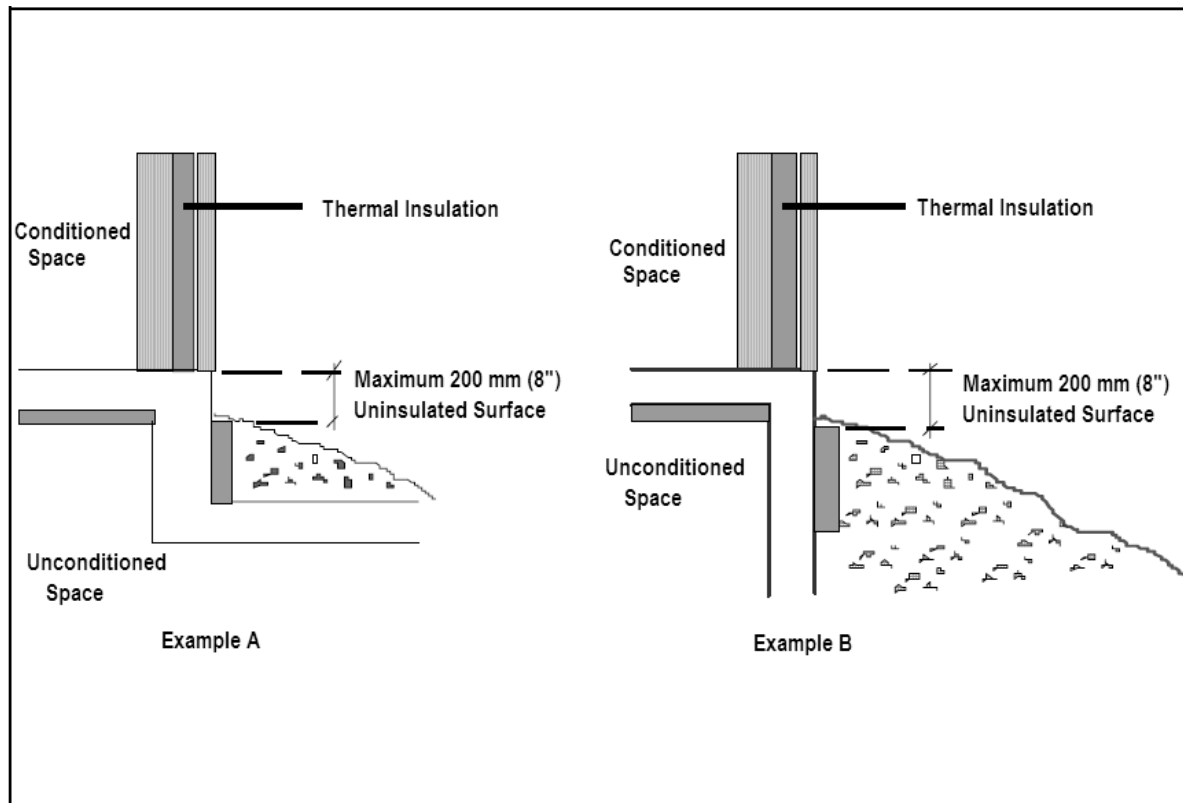


Figure 5-3
Maximum Uninsulated Surface of Foundation Wall

- (3) Section 5.5.4.5 of 2013 ANSI/ASHRAE/IES 90.1 shall only be applicable where the main entrance is located on the south orientation and the south oriented wall area is larger than west oriented wall area, and where the south oriented wall area is larger than east oriented wall area. (See Appendix A.)
- (4) The *building* envelope trade-off option in Section 5.6 of 2013 ANSI/ASHRAE/IES 90.1 shall not apply unless the procedure incorporates the modifications made to 2013 ANSI/ASHRAE/IES 90.1 through this Chapter.
- (5) Section 5.8.2.4.A shall be added to Section 5.8.2.4 “Air Leakage” of 2013 ANSI/ASHRAE/IES 90.1.

5.8.2.4.A Alternative Standards to determine Thermal Characteristics of Fenestrations

- (1) Notwithstanding Sections 5.8.2.3 and 5.8.2.4, thermal characteristics of fenestrations are permitted to be determined in conformance with;
 - (a) CAN/CSA-A440.2, “Fenestration Energy Performance”, or
 - (b) NFRC 100, “Procedure for Determining Fenestration Product U-factors” and NFRC 200, “Procedure for Determining Fenestration Product Solar Heat Gain Coefficient and Visible Transmittance at Normal Incidence”.

TABLE SB 5.5-5-2017 (See Appendix A.)
(Supersedes Table 5.5-5 in 2013 ANSI/ASHRAE/IES 90.1)
Building Envelope Requirements for Climate Zone 5 (A, B, C) (SI)

Opaque Elements	Nonresidential		Residential		Semiheated				
	Assembly	Insulation	Assembly	Insulation	Assembly	Insulation			
	Max. U-Value	Min. RSI-Value	Max. U-Value	Min. RSI-Value	Max. U-Value	Min. RSI-Value			
Roofs									
Insulation Entirely Above Deck	U-0.164	6.2 ci	U-0.164	6.2 ci	U-0.322	3.0 ci			
Metal Building ^a	U-0.189	4.4 + 1.9 Ls	U-0.189	4.4 + 1.9 Ls	U-0.419	1.8 + 3.3			
Attic and Other	U-0.107	10.6	U-0.107	10.6	U-0.174	6.7			
Walls, Above Grade									
Mass	U-0.307	3.0 ci	U-0.273	3.3 ci	U-0.514	1.8 ci			
Metal Building	U-0.256	2.3 + 3.3 ci	U-0.256	2.3 + 3.3 ci	U-0.480	2.3 + 1.1 ci			
Steel Framed	U-0.281	2.3 + 2.1 ci	U-0.281	2.3 + 2.1 ci	U-0.429	2.3 + 1.1 ci			
Wood Framed and Other	U-0.261	2.3 + 1.8 ci	U-0.261	2.3 + 1.8 ci	U-0.455	2.3 + 0.2 ci			
Wall, Below Grade									
Below Grade Wall	C-0.380	2.6 ci	C-0.380	2.6 ci	C-0.676	1.3 ci			
Floors									
Mass	U-0.291	2.9 ci	U-0.261	3.3 ci	U-0.547	1.3 ci			
Steel Joist	U-0.194	6.7	U-0.194	6.7	U-0.266	4.4			
Wood Framed and Other	U-0.169	6.7	U-0.169	6.7	U-0.261	3.7			
Slab-On-Grade Floors									
Unheated	F-0.810	2.6 for 1200 mm	F-0.794	2.6 for 1200 mm	F-1.263	NR			
Heated	F-1.072	1.8 full slab	F-1.072	1.8 full slab	F-1.402	1.8 for 1200 mm			
Opaque Doors									
Swinging	U-2.56		U-2.56		U-3.58				
Nonswinging	U-2.56		U-2.56		U-7.41				
Fenestration	Assembly	Assembly		Assembly	Assembly		Assembly	Assembly	
	Max. U-Value	Max. SHGC	Min. VT/SHGC	Max. U-Value	Max. SHGC	Min. VT/SHGC	Max. U-Value	Max. SHGC	Min. VT/SHGC
Vertical Fenestration, 0% - 40% of Wall									
Nonmetal framing: all	U-1.64	0.40	1.10	U-1.64	0.40	1.10	U-2.30	NR	NR
Metal framing: fixed	U-2.15			U-2.15			U-3.17		
Metal framing: operable	U-2.56			U-2.56			U-3.58		
Metal framing: entrance door	U-3.94			U-3.48			U-3.94		
Skylight, 0% - 3% of Roof									
All types	U-2.56	0.40	NR	U-2.56	0.40	NR	U-5.01	NR	NR

The following definitions apply: ci = continuous insulation, Ls = liner system, NR = no (insulation) requirement.

^a When using the RSI-value compliance method for metal building roofs, a thermal spacer block is required.

TABLE SB 5.5-6-2017 (See Appendix A.)
(Supersedes Table 5.5-6 in 2013 ANSI/ASHRAE/IES 90.1)
Building Envelope Requirements for Climate Zone 6 (A, B) (SI)

Opaque Elements	Nonresidential		Residential		Semiheated				
	Assembly	Insulation	Assembly	Insulation	Assembly	Insulation			
	Max. U-Value	Min. RSI-Value	Max. U-Value	Min. RSI-Value	Max. U-Value	Min. RSI-Value			
Roofs									
Insulation Entirely Above Deck	U-0.164	6.2 ci	U-0.164	6.2 ci	U-0.322	3.0 ci			
Metal Building ^a	U-0.158	4.4 + 1.9 + 1.9 Ls	U-0.148	4.4 + 1.9 + 1.9 Ls	U-0.307	3.3 + 1.9 Ls			
Attic and Other	U-0.107	10.6	U-0.107	10.6	U-0.174	6.7			
Walls, Above Grade									
Mass	U-0.273	3.3 ci	U-0.261	3.5 ci	U-0.514	1.8 ci			
Metal Building	U-0.256	2.3 + 3.3 ci	U-0.256	2.3 + 3.3 ci	U-0.480	2.3 + 1.1 ci			
Steel Framed	U-0.250	2.3 + 2.6 ci	U-0.250	2.3 + 2.6 ci	U-0.429	2.3 + 1.1 ci			
Wood Framed and Other	U-0.261	2.3 + 1.8 ci	U-0.261	2.3 + 1.8 ci	U-0.455	2.3 + 0.2 ci			
Wall, Below Grade									
Below Grade Wall	C-0.284	3.5 ci	C-0.284	3.5 ci	C-0.676	1.3 ci			
Floors									
Mass	U-0.261	3.3 ci	U-0.261	3.3 ci	U-0.445	1.7 ci			
Steel Joist	U-0.164	6.7 + 0.7 ci	U-0.164	6.7 + 0.7 ci	U-0.266	4.4			
Wood Framed and Other	U-0.138	6.7 + 0.5 ci	U-0.138	6.7 + 0.5 ci	U-0.261	3.7			
Slab-On-Grade Floors									
Unheated	F-0.794	2.6 for 1200 mm	F-0.676	1.8 full slab	F-1.263	NR			
Heated	F-1.072	1.8 full slab	F-1.045	1.8 full slab	F-1.340	2.6 for 1200 mm			
Opaque Doors									
Swinging	U-2.56		U-2.56		U-3.58				
Nonswinging	U-2.56		U-2.56		U-2.56				
Fenestration	Assembly	Assembly		Assembly	Assembly		Assembly	Assembly	
	Max. U-Value	Max. SHGC	Min. VT/SHGC	Max. U-Value	Max. SHGC	Min. VT/SHGC	Max. U-Value	Max. SHGC	Min. VT/SHGC
Vertical Fenestration, 0% - 40% of Wall									
Nonmetal framing: all	U-1.64	.40	1.10	U-1.64	0.40	1.10	U-2.30	NR	NR
Metal framing: fixed	U-2.15			U-2.15			U-2.61		
Metal framing: operable	U-2.56			U-2.56			U-3.02		
Metal framing: entrance door	U-3.94			U-3.48			U-3.94		
Skylight, 0% - 3% of Roof									
All types	U-2.56	0.40	NR	U-2.56	0.40	NR	U-4.34	NR	NR

The following definitions apply: ci = continuous insulation, Ls = liner system, NR = no (insulation) requirement.

^a When using the RSI-value compliance method for metal building roofs, a thermal spacer block is required.

TABLE SB 5.5-7-2017 (See Appendix A.)
(Supersedes Table 5.5-7 in 2013 ANSI/ASHRAE/IES 90.1)
Building Envelope Requirements for Climate Zone 7 (SI)

Opaque Elements	Nonresidential		Residential		Semiheated				
	Assembly	Insulation	Assembly	Insulation	Assembly	Insulation			
	Max. U-Value	Min. RSI-Value	Max. U-Value	Min. RSI-Value	Max. U-Value	Min. RSI-Value			
Roofs									
Insulation Entirely Above Deck	U-0.143	7.0 ci	U-0.143	7.0 ci	U-0.199	4.9 ci			
Metal Building ^a	U-0.148	4.4 + 1.9 + 1.9 Ls	U-0.148	4.4 + 1.9 + 1.9 Ls	U-0.189	4.4 + 1.9 Ls			
Attic and Other	U-0.087	12.5	U-0.087	12.5	U-0.138	8.6			
Walls, Above Grade									
Mass	U-0.261	3.5 ci	U-0.261	3.5 ci	U-0.419	2.1 ci			
Metal Building	U-0.225	2.3 + 3.3 ci	U-0.225	2.3 + 3.3 ci	U-0.368	2.3 + 1.7 ci			
Steel Framed	U-0.250	2.3 + 2.6 ci	U-0.215	2.3 + 3.5 ci	U-0.327	2.3 + 1.8 ci			
Wood Framed and Other	U-0.261	2.3 + 1.8 ci	U-0.261	2.3 + 1.8 ci	U-0.327	2.3 + 1.1 ci			
Wall, Below Grade									
Below Grade Wall	C-0.284	3.5 ci	C-0.284	3.5 ci	C-0.676	1.3 ci			
Floors									
Mass	U-0.215	4.1 ci	U-0.215	4.1 ci	U-0.378	2.1 ci			
Steel Joist	U-0.164	6.7 + 0.7 ci	U-0.164	6.7 + 0.7 ci	U-0.266	4.4			
Wood Framed and Other	U-0.138	6.7 + 0.5 ci	U-0.138	6.7 + 0.5 ci	U-0.261	3.7			
Slab-On-Grade Floors									
Unheated	F-0.794	2.6 for 1200 mm	F-0.676	1.8 full slab	F-1.263	NR			
Heated	F-1.045	1.8 full slab	F-1.045	1.8 full slab	F-1.340	2.6 for 1200 mm			
Opaque Doors									
Swinging	U-2.56		U-2.56		U-3.58				
Nonswinging	U-2.56		U-2.56		U-2.56				
Fenestration	Assembly	Assembly		Assembly	Assembly		Assembly	Assembly	
	Max. U-Value	Max. SHGC	Min. VT/SHGC	Max. U-Value	Max. SHGC	Min. VT/SHGC	Max. U-Value	Max. SHGC	Min. VT/SHGC
Vertical Fenestration, 0% - 40% of Wall									
Nonmetal framing: all	U-1.64	0.45	1.10	U-1.64	0.45	1.10	U-1.64	NR	NR
Metal framing: fixed	U-1.94			U-1.94			U-1.94		
Metal framing: operable	U-2.04			U-2.04			U-2.25		
Metal framing: entrance door	U-3.94			U-3.48			U-3.94		
Skylight, 0% - 3% of Roof									
All types	U-2.56	NR	NR	U-2.56	NR	NR	U-4.34	NR	NR

The following definitions apply: ci = continuous insulation, Ls = liner system, NR = no (insulation) requirement.

^a When using the RSI-value compliance method for metal building roofs, a thermal spacer block is required.

TABLE SB 5.5-5-2017 (See Appendix A.)
(Supersedes Table 5.5-5 in 2013 ANSI/ASHRAE/IES 90.1)
Building Envelope Requirements for Climate Zone 5 (A, B, C) (I-P)

Opaque Elements	Nonresidential		Residential		Semiheated				
	Assembly	Insulation	Assembly	Insulation	Assembly	Insulation			
	Max. U-Value	Min. R-Value	Max. U-Value	Min. R-Value	Max. U-Value	Min. R-Value			
Roofs									
Insulation Entirely Above Deck	U-0.029	R-35 ci	U-0.029	R-35 ci	U-0.057	R-17 ci			
Metal Building ^a	U-0.033	R-25 + R-11 Ls	U-0.033	R-25 + R-11 Ls	U-0.074	R-10 + R-19			
Attic and Other	U-0.019	R-60	U-0.019	R-60	U-0.031	R-38			
Walls, Above Grade									
Mass	U-0.054	R-17 ci	U-0.048	R-19 ci	U-0.091	R-10 ci			
Metal Building	U-0.045	R-13 + R-19 ci	U-0.045	R-13 + R-19 ci	U-0.085	R-13 + R-6.3 ci			
Steel Framed	U-0.050	R-13 + R-12 ci	U-0.050	R-13 + R-12 ci	U-0.076	R-13 + R-6.3 ci			
Wood Framed and Other	U-0.046	R-13 + R-10 ci	U-0.046	R-13 + R-10 ci	U-0.080	R-13 + R-1 ci			
Wall, Below Grade									
Below Grade Wall	C-0.067	R-15 ci	C-0.067	R-15 ci	C-0.119	R-7.4 ci			
Floors									
Mass	U-0.051	R-16.4 ci	U-0.046	R-18.7 ci	U-0.096	R-7.4 ci			
Steel Joist	U-0.034	R-38	U-0.034	R-38	U-0.047	R-25			
Wood Framed and Other	U-0.030	R-38	U-0.030	R-38	U-0.046	R-21			
Slab-On-Grade Floors									
Unheated	F-0.468	R-15 for 48 in.	F-0.459	R-15 for 48 in.	F-0.730	NR			
Heated	F-0.619	R-10 full slab	F-0.619	R-10 full slab	F-0.810	R-10 for 48 in.			
Opaque Doors									
Swinging	U-0.45		U-0.45		U-0.63				
Nonswinging	U-0.45		U-0.45		U-1.31				
Fenestration	Assembly	Assembly		Assembly	Assembly		Assembly	Assembly	
	Max. U-Value	Max. SHGC	Min. VT/SHGC	Max. U-Value	Max. SHGC	Min. VT/SHGC	Max. U-Value	Max. SHGC	Min. VT/SHGC
Vertical Fenestration, 0% - 40% of Wall									
Nonmetal framing: all	U-0.29	0.40	1.10	U-0.29	0.40	1.10	U-0.41	NR	NR
Metal framing: fixed	U-0.38			U-0.38			U-0.56		
Metal framing: operable	U-0.45			U-0.45			U-0.63		
Metal framing: entrance door	U-0.69			U-0.61			U-0.69		
Skylight, 0% - 3% of Roof									
All types	U-0.45	0.40	NR	U-0.45	0.40	NR	U-0.88	NR	NR

The following definitions apply: ci = continuous insulation, Ls = liner system, NR = no (insulation) requirement.

^a When using the R-value compliance method for metal building roofs, a thermal spacer block is required.

TABLE SB 5.5-6-2017 (See Appendix A.)
(Supersedes Table 5.5-6 in 2013 ANSI/ASHRAE/IES 90.1)
Building Envelope Requirements for Climate Zone 6 (A, B) (I-P)

Opaque Elements	Nonresidential			Residential			Semiheated			
	Assembly	Insulation		Assembly	Insulation		Assembly	Insulation		
	Max. U-Value	Min. R-Value		Max. U-Value	Min. R-Value		Max. U-Value	Min. R-Value		
Roofs										
Insulation Entirely Above Deck	U-0.029	R-35 ci		U-0.029	R-35 ci		U-0.057	R-17 ci		
Metal Building ^a	U-0.028	R-25 + R-11 + R-11 Ls		U-0.026	R-25 + R-11 + R-11 Ls		U-0.054	R-19 + R-11 Ls		
Attic and Other	U-0.019	R-60		U-0.019	R-60		U-0.031	R-38		
Walls, Above Grade										
Mass	U-0.048	R-19 ci		U-0.046	R-20 ci		U-0.091	R-10 ci		
Metal Building	U-0.045	R-13 + R-19 ci		U-0.045	R-13 + R-19 ci		U-0.085	R-13 + R-6.5 ci		
Steel Framed	U-0.044	R-13 + R-15 ci		U-0.044	R-13 + R-15 ci		U-0.076	R-13 + R-6 ci		
Wood Framed and Other	U-0.046	R-13 + R-10 ci		U-0.046	R-13 + R-10 ci		U-0.080	R-13 + R-1 ci		
Wall, Below Grade										
Below Grade Wall	C-0.050	R-20 ci		C-0.050	R-20 ci		C-0.119	R-7.5 ci		
Floors										
Mass	U-0.046	R-18.7 ci		U-0.046	R-18.7 ci		U-0.078	R-9.7 ci		
Steel Joist	U-0.029	R-38 + R-4 ci		U-0.029	R-38 + R-4 ci		U-0.047	R-25		
Wood Framed and Other	U-0.024	R-38 + R-3 ci		U-0.024	R-38 + R-3 ci		U-0.046	R-21		
Slab-On-Grade Floors										
Unheated	F-0.459	R-15 for 48 in.		F-0.391	R-10 full slab		F-0.730	NR		
Heated	F-0.619	R-10 full slab		F-0.604	R-10 full slab		F-0.774	R-15 for 48 in.		
Opaque Doors										
Swinging	U-0.45			U-0.45			U-0.63			
Nonswinging	U-0.45			U-0.45			U-0.45			
Fenestration	Assembly	Assembly		Assembly	Assembly		Assembly	Assembly		
	Max. U-Value	Max. SHGC	Min. VT/SHGC	Max. U-Value	Max. SHGC	Min. VT/SHGC	Max. U-Value	Max. SHGC	Min. VT/SHGC	
Vertical Fenestration, 0% - 40% of Wall										
Nonmetal framing: all	U-0.29	0.40	1.10	U-0.29	0.40	1.10	U-0.41	NR	NR	
Metal framing: fixed	U-0.38			U-0.38			U-0.46			
Metal framing: operable	U-0.45			U-0.45			U-0.53			
Metal framing: entrance door	U-0.69			U-0.61			U-0.69			
Skylight, 0% - 3% of Roof										
All types	U-0.45	0.40	NR	U-0.45	0.40	NR	U-0.77	NR	NR	

The following definitions apply: ci = continuous insulation, Ls = liner system, NR = no (insulation) requirement.

^a When using the R-value compliance method for metal building roofs, a thermal spacer block is required.

TABLE SB 5.5-7-2017 (See Appendix A.)
(Supersedes Table 5.5-7 in 2013 ANSI/ASHRAE/IES 90.1)
Building Envelope Requirements for Climate Zone 7 (I-P)

Opaque Elements	Nonresidential			Residential			Semiheated			
	Assembly	Insulation		Assembly	Insulation		Assembly	Insulation		
	Max. U-Value	Min. R-Value		Max. U-Value	Min. R-Value		Max. U-Value	Min. R-Value		
Roofs										
Insulation Entirely Above Deck	U-0.025	R-40 ci		U-0.025	R-40 ci		U-0.035	R-28 ci		
Metal Building ^a	U-0.026	R-25 + R-11 + R-11 Ls		U-0.026	R-25 + R-11 + R-11 Ls		U-0.033	R-25 + R-11 Ls		
Attic and Other	U-0.015	R-71		U-0.015	R-71		U-0.024	R-49		
Walls, Above Grade										
Mass	U-0.046	R-20 ci		U-0.046	R-20 ci		U-0.074	R-12 ci		
Metal Building	U-0.040	R-13 + R-19 ci		U-0.040	R-13 + R-19 ci		U-0.065	R-13 + R-9.8 ci		
Steel Framed	U-0.044	R-13 + R-15 ci		U-0.038	R-13 + R-20 ci		U-0.058	R-13 + R-10 ci		
Wood Framed and Other	U-0.046	R-13 + R-10 ci		U-0.046	R-13 + R-10 ci		U-0.058	R-13 + R-6 ci		
Wall, Below Grade										
Below Grade Wall	C-0.050	R-20 ci		C-0.050	R-20.0 ci		C-0.119	R-7.5 ci		
Floors										
Mass	U-0.038	R-23.4 ci		U-0.038	R-23.4 ci		U-0.067	R-12 ci		
Steel Joist	U-0.029	R-38 + R-4 ci		U-0.029	R-38 + R-4 ci		U-0.047	R-25		
Wood Framed and Other	U-0.024	R-38 + R-3 ci		U-0.024	R-38 + R-3 ci		U-0.046	R-21		
Slab-On-Grade Floors										
Unheated	F-0.459	R-15 for 48 in.		F-0.391	R-10 full slab		F-0.730	NR		
Heated	F-0.604	R-10 full slab		F-0.604	R-10 full slab		F-0.774	R-15 for 48 in.		
Opaque Doors										
Swinging	U-0.45			U-0.45			U-0.63			
Nonswinging	U-0.45			U-0.45			U-0.45			
Fenestration	Assembly	Assembly		Assembly	Assembly		Assembly	Assembly		
	Max. U-Value	Max. SHGC	Min. VT/SHGC	Max. U-Value	Max. SHGC	Min. VT/SHGC	Max. U-Value	Max. SHGC	Min. VT/SHGC	
Vertical Fenestration, 0% - 40% of Wall										
Nonmetal framing: all	U-0.29	0.45	1.10	U-0.29	0.45	1.10	U-0.29	NR	NR	
Metal framing: fixed	U-0.34			U-0.34			U-0.34			
Metal framing: operable	U-0.36			U-0.36			U-0.40			
Metal framing: entrance door	U-0.69			U-0.61			U-0.69			
Skylight, 0% - 3% of Roof										
All types	U-0.45	NR	NR	U-0.45	NR	NR	U-0.77	NR	NR	

The following definitions apply: ci = continuous insulation, Ls = liner system, NR = no (insulation) requirement.

^a When using the R-value compliance method for metal building roofs, a thermal spacer block is required.

1.1.1.5. Heating Ventilation and Air-Conditioning

- (1) Where *electric space heating* is used, the *building* envelope shall comply with the requirements of Table SB 5.5-7–2017 of this Supplementary Standard, regardless of its climatic zone.
- (2) Section 6.4.1.A shall be added to Section 6 “Heating Ventilation and Air Conditioning Equipment” of 2013 ANSI/ASHRAE/IES 90.1.

6.4.1.A. Testing Procedures for Minimum Equipment Efficiency

- (1) Equipment efficiencies that are tested in accordance with the test procedures listed in the 2015 NECB or in an applicable Ontario Regulation, shall be deemed to be in compliance with the test procedures given in Tables 6.8.1-1 to 6.8.1-13.
- (3) Fan systems shall have fan power limitations 10% below limitations specified in Table 6.5.3.1-1 of 2013 ANSI/ASHRAE/IES-90.1.
- (4) Energy recovery systems required in 6.5.6.1 of 2013 ANSI/ASHRAE/IES-90.1 shall have at least 55% energy recovery effectiveness.

1.1.1.6. HVAC and Service Water Heating Equipment – Minimum Equipment Efficiency

- (1) The minimum equipment efficiency of a gas-fired boiler shall comply with the value required in Table SB 6.8.1–2017.
- (2) The minimum equipment efficiency of a gas-fired storage water heater shall comply with the value required in Table SB 6.8.1–2017.

Table SB 6.8.1–2017
Minimum Equipment Efficiency for Gas Boilers and Gas Water Heaters
Forming Part of Sentences 1.1.1.6.(1) and (2)

Equipment	Size Category, kW (Btu/h)	Performance Required
Gas boilers, hot water	< 88 (< 300,000)	90% AFUE
	≥ 88 and < 733 (≥ 300,000 and < 2,500,000)	90% E _t
Gas water heaters	≤ 22 (≤ 75,000)	0.7 - 0.0005V (V in litres) EF (0.7 - 0.00189V, V in U.S. gal)
Column 1	2	3

1.1.1.7. Service Water Heating Equipment

- (1) Section 7.4.2.A shall be added to Section 7 “Service Water Heating Equipment ” of 2013 ANSI/ASHRAE/IES 90.1.

7.4.2.A Testing Procedures for Minimum Equipment Efficiency

- (1) Equipment efficiencies that are tested in accordance with the test procedures listed in the 2015 NECB or in an applicable Ontario Regulation, shall be deemed to be in compliance with the test procedures given in Table 7.8.
- (2) Section 7.4.5.2 of Section 7 “Service Water Heating Equipment” of 2013 ANSI/ASHRAE/IES 90.1 shall be substituted with the following Article:

7.4.5.2 Pool Covers. Heated exterior public pools and public spas shall be equipped with pool covers.

Exception. Pools deriving over 60% of their energy for heating (computed over an annual operating season) from site-recovered or site-solar energy.

1.1.1.8. Power, Lighting and Other Equipment

- (1) Automatic receptacle controls required in Section 8.4.2 of 2013 ANSI/ASHRAE/IES 90.1 shall not apply to private and open offices.
- (2) Section 8.4.3.3 shall be added to Section 8.4.3. “Electric Energy monitoring” of 2013 ANSI/ASHRAE/IES 90.1.

8.4.3.3 The building shall be deemed to comply with Sections 8.4.3.1 and 8.4.3.2 if the building is designed and constructed to facilitate future installation of means to measure and monitor energy use of the building parts and systems described in Section 8.4.3.1. (See Appendix A.)

- (3) Section 9.4.1.2.(b) of 2013 ANSI/ASHRAE/IES 90.1 shall be substituted with the following:

9.4.1.2.(b) Lighting shall be controlled by one or more devices that automatically reduce lighting power by a minimum of 30% when there is no activity detected within a lighting zone for no more than 20 minutes. Lighting zone for this requirement shall be no larger than 334 m² (3600 ft²).
- (4) Uncovered parking areas are exempt from the requirements of Section 9.4.1.4.(c) of 2013 ANSI/ASHRAE/IES 90.1.

1.1.1.9. Lighting Power Allowance and Controls

- (1) The calculation of interior lighting power allowance shall be based on the lighting power densities given in Table SB 9.5.1–2017 or Table SB 9.6.1–2017 of this Chapter.
- (2) Except as provided in Sentence (4), for the purpose of Sentence (1), any reference to Table 9.5.1 and the lighting power densities contained in Table 9.6.1 of 2013 ANSI/ASHRAE/IES-90.1 shall be deemed to be a reference to Table SB 9.5.1–2017 and the lighting power densities listed in Table SB 9.6.1–2017 of this Chapter respectively.
- (3) Lighting power densities listed in Table SB 9.5.1–2017 and Table SB 9.6.1–2017 of this Chapter shall supersede the lighting power densities listed in Table 9.5.1 and Table 9.6.1 of 2013 ANSI/ASHRAE/IES-90.1 respectively.
- (4) Minimum lighting control requirements in Table 9.6.1 of 2013 ANSI/ASHRAE/IES-90.1 shall apply.

Table SB 9.5.1–2017
 Lighting Power Densities Using the Building Area Method⁽¹⁾
 Forming Part of Sentences 1.1.1.9.(1) to (3)

Building Area Type	Lighting Power Density, W/m ² (W/ft ²)
Automotive Facility	7.6 (0.71)
Convention Centre	8.2 (0.76)
Courthouse	9.7 (0.90)
Dining	
Bar Lounge / Leisure	9.7 (0.90)
Cafeteria / Fast Food	8.5 (0.79)
Family	8.4 (0.78)
Dormitory	6.6 (0.61)
Exercise Centre	7.0 (0.65)
Fire Station	5.7 (0.53)
Gymnasium	7.3 (0.68)
Health-Care Clinic	8.8 (0.82)
Hospital	11.3 (1.05)
Hotel	8.1 (0.75)
Library	8.4 (0.78)
Manufacturing Facility	9.7 (0.90)
Motel	8.1 (0.75)
Motion Picture Theatre	8.9 (0.83)
Multi-Unit Residential Building	7.3 (0.68)
Museum	11.4 (1.06)
Office	8.5 (0.79)
Storage Garage	1.6 (0.15)
Penitentiary	8.1 (0.75)
Performing Arts Theatre	12.7 (1.18)
Police Station	8.6 (0.80)
Post Office	7.2 (0.67)
Religious Building	10.1 (0.94)
Retail	11.4 (1.06)
School / University	8.7 (0.81)
Sports Arena	9.4 (0.87)
Town Hall	8.6 (0.80)
Transportation	6.6 (0.61)
Warehouse	5.2 (0.48)
Workshop	9.7 (0.90)
Column 1	2

Notes to Table SB 9.5.1–2017:

(1) Terms shall have the same meanings as they have in 2013 ANSI/ASHRAE/IES-90.1.

Table SB 9.6.1–2017
Lighting Power Densities Using the Space-by-Space Method⁽¹⁾
Forming Part of Sentences 1.1.1.9.(1) to (3)

Common Space Types	Lighting Power Density, W/m ² (W/ft ²)
Atrium	
< 6 m in height	1.06 per m in height (0.03 per ft in height)
≥ 6 m and ≤ 12 m in height	1.06 per m in height (0.03 per ft in height)
> 12 m in height	4.31 + 0.71 per m in height (0.40 + 0.02 per ft in height)
Audience / Seating Area-Permanent	
For Auditorium	6.8 (0.63)
For Convention Centre	8.8 (0.82)
For Gymnasium	7.0 (0.65)
For Motion Picture Theatre	12.3 (1.14)
For Penitentiary	3.0 (0.28)
For Performing Arts Theatre	21.8 (2.03)
For Religious Buildings	16.5 (1.53)
For Sports Arena	4.6 (0.43)
Other	4.6 (0.43)
Banking Activity Area and Offices	9.3 (0.86)
Classroom / Lecture / Training	
For Penitentiary	14.4 (1.34)
Other	10.3 (0.96)
Computer / Server Room	14.3 (1.33)
Conference / Meeting / Multi-Purpose	11.5 (1.07)
Confinement Cell	8.7 (0.81)
Copy / Print Room	6.0 (0.56)
Corridor / Transition Area	
For space designed to ANSI/IES RP- 28 ⁽²⁾ (and used primarily by residents)	9.9 (0.92)
For Hospital	9.9 (0.92)
For Manufacturing Facility	3.1 (0.29)
Other	7.1 (0.66)
Courtroom	15.0 (1.39)
Dining Area	
For Bar Lounge / Leisure Dining	10.0 (0.93)
For Cafeteria / Fast Food Dining	6.8 (0.63)
For Family Dining	7.6 (0.71)
For space designed to ANSI/IES RP-28 ⁽²⁾ (and used primarily by residents)	21.5 (2.00)
For Penitentiary	10.3 (0.96)
Other	6.8 (0.63)
Column 1	2

Table SB 9.6.1-2017 (Cont'd)
Lighting Power Densities Using the Space-by-Space Method
Forming Part of Sentences 1.1.1.9.(1) to (3)

Building-Specific Space Types	Lighting Power Density, W/m ² (W/ft ²)
Dressing / Fitting Room For Performing Arts Theatre	6.6 (0.61)
Electrical / Mechanical Room	4.6 (0.43)
Emergency Vehicle Garage	4.4 (0.41)
Food Preparation Area	11.4 (1.06)
Guest Room	8.3 (0.77)
Laboratory	
For Classrooms	12.9 (1.20)
Other	15.6 (1.45)
Laundry / Washing Area	4.6 (0.43)
Loading Dock, Interior	6.2 (0.58)
Lobby	
For space designed to ANSI/IES RP-28 ⁽²⁾ (and used primarily by residents)	21.8 (2.03)
For Elevator	7.3 (0.68)
For Hotel	11.4 (1.06)
For Motion Picture Theatre	4.8 (0.45)
For Performing Arts Theatre	18.3 (1.70)
Other	10.8 (1.00)
Locker Room	5.2 (0.48)
Lounge / Break Room	
For Healthcare Facility	8.4 (0.78)
Other	6.7 (0.62)
Office	
Enclosed	10.0 (0.93)
Open Plan	8.7 (0.81)
Storage Garage, Interior	1.5 (0.14)
Pharmacy Area	14.4 (1.34)
Sales Area	13.1 (1.22)
Seating Area, General	4.6 (0.43)
Stairway	6.2 (0.58)
Storage Room $\geq 5 \text{ m}^2$ and $< 100 \text{ m}^2$	6.8 (0.63)
Storage Room $< 5 \text{ m}^2$	10.4 (0.97)
Vehicular Maintenance Area	6.0 (0.56)
Washroom	
For care occupancy designed to ANSI/IES RP-28 ⁽²⁾ (and used primarily by residents)	13.1 (1.22)
Other	9.1 (0.85)
Workshop	12.3 (1.14)
Column 1	2

Table SB 9.6.1-2017 (Cont'd)
 Lighting Power Densities Using the Space-by-Space Method
 Forming Part of Sentences 1.1.1.9.(1) to (3)

Building-Specific Space Types	Lighting Power Density, W/m ² (W/ft ²)
Care occupancy designed to ANSI/IES RP-28 ⁽²⁾	
For Chapel (used primarily by residents) 23.811.4	11.4 (1.06)
For Recreation Room (used primarily by residents)	19.4 (1.80)
Convention Centre	
Exhibit Space	9.5 (0.88)
Dormitory	
Living Quarters	5.8 (0.54)
Fire Station	
Sleeping Quarters	2.2 (0.20)
Gymnasium / Fitness Centre	
Exercise Area	5.4 (0.50)
Playing Area	8.8 (0.82)
Healthcare Facility	
Exam / Treatment Room	18.1 (1.68)
Medical Supply Room	5.8 (0.54)
Nursery	10.8 (1.00)
Nurses' Station	8.7 (0.81)
Operating Room	23.4 (2.17)
Patient Room	6.7 (0.62)
Physical Therapy	9.0 (0.84)
Imaging Room	11.4 (1.06)
Recovery	11.1 (1.03)
Library	
Reading Area	8.8 (0.82)
Stacks	12.9 (1.20)
Manufacturing Facility	
Detailed Manufacturing Area	10.0 (0.93)
Equipment Room	7.0 (0.65)
Extra High Bay (> 15 m floor to ceiling height)	11.3 (1.05)
High Bay (7.5 m to 15 m floor to ceiling height)	8.1 (0.75)
Low Bay (< 7.5 m floor to ceiling height)	10.3 (0.96)
Column 1	2

Table SB 9.6.1-2017 (Cont'd)
Lighting Power Densities Using the Space-by-Space Method
Forming Part of Sentences 1.1.1.9.(1) to (3)

Building-Specific Space Types	Lighting Power Density, W/m ² (W/ft ²)
Museum	
General Exhibition	11.3 (1.05)
Restoration	9.2 (0.85)
Post Office	7.3 (0.68)
Sorting Area	
Religious Building	
Fellowship Hall	5.9 (0.55)
Worship / Pulpit / Choir	16.5 (1.53)
Retail Facilities	
Dressing / Fitting Room	5.4 (0.50)
Mall Concourse	9.7 (0.90)
Sports Arena – Playing Area	
Class IV Facility	12.2 (1.13)
Class III Facility	18.3 (1.70)
Class II Facility	21.1 (1.96)
Class I Facility	26.6 (2.47)
Transportation Facility	
Baggage / Carousel Area	4.8 (0.45)
Airport Concourse	3.3 (0.31)
Terminal Ticket Counter	6.7 (0.62)
Warehouse	
Small, Hand-Carried Items	7.4 (0.69)
Medium To Bulky, Palletized Items	3.8 (0.35)
Column 1	2

Notes to Table SB 9.6.1-2017:

- (1) Terms shall have the same meanings as they have in 2013 ANSI/ASHRAE/IES-90.1.
- (2) BSR/IES RP-28-16, "Lighting and the Visual Environment for Seniors and the Low Vision Population".

- (5) The calculation of exterior lighting power allowance shall be based on Table SB 9.4.2-2-2017 of this Chapter.
- (6) Lighting power allowances listed in Table SB 9.4.2-2-2017 of this Chapter shall supersede the lighting power allowances listed in Table 9.4.2-2 of 2013 ANSI/ASHRAE/IES 90.1.

TABLE SB 9.4.2-2-2017
(Supersedes Table 9.4.2-2 in 2013 ANSI/ASHRAE/IES 90.1)
Individual Lighting Power Allowances for Building Exteriors
 Forming Part of Sentences 1.1.1.9.(5) and (6)

	Zone 0	Zone 1	Zone 2	Zone 3	Zone 4
Base Site Allowance (base allowance may be used in tradable or non-tradable surfaces)					
	No allowance	350 W	400 W	500 W	900 W
Tradable Surfaces (LPDs for uncovered parking areas, building grounds, building entrances, exits and loading docks, canopies and overhangs, and outdoor sales areas may be traded.)					
Uncovered Parking Areas					
Parking areas and drives	No allowance	0.32 W/m ² (0.03 W/ft ²)	0.43 W/m ² (0.04 W/ft ²)	0.65 W/m ² (0.06 W/ft ²)	0.86 W/m ² (0.08 W/ft ²)
Building Grounds					
Walkways less than 3 m (10 ft) wide	No allowance	1.6 W/m ² (0.50 W/ft ²)	1.6 W/m ² (0.50 W/ft ²)	2.0 W/m ² (0.60 W/ft ²)	2.3 W/m ² (0.70 W/ft ²)
Walkways 3 m (10 ft) wide or greater	No allowance	1.1 W/m ² (0.10 W/ft ²)	1.1 W/m ² (0.10 W/ft ²)	1.2 W/m ² (0.11 W/ft ²)	1.5 W/m ² (0.14 W/ft ²)
Plaza areas	No allowance	1.1 W/m ² (0.10 W/ft ²)	1.1 W/m ² (0.10 W/ft ²)	1.2 W/m ² (0.11 W/ft ²)	1.5 W/m ² (0.14 W/ft ²)
Stairways	No allowance	6.5 W/m ² (0.60 W/ft ²)	7.5 W/m ² (0.70 W/ft ²)	7.5 W/m ² (0.70 W/ft ²)	7.5 W/m ² (0.70 W/ft ²)
Pedestrian Tunnels	No allowance	1.3 W/m ² (0.12 W/ft ²)	1.3 W/m ² (0.12 W/ft ²)	1.5 W/m ² (0.14 W/ft ²)	2.3 W/m ² (0.21 W/ft ²)
Landscaping	No allowance	0.32 W/m ² (0.03 W/ft ²)	0.43 W/m ² (0.04 W/ft ²)	0.43 W/m ² (0.04 W/ft ²)	0.43 W/m ² (0.04 W/ft ²)
Building Entrances, Exits, and Loading Docks					
Pedestrian and vehicular entrances and exits	No allowance	46 W/m (14 W/ft) of door width	46 W/m (14 W/ft) of door width	69 W/m (21 W/ft) of door width	69 W/m (21 W/ft) of door width
Entry canopies	No allowance	2.1 W/m ² (0.20 W/ft ²)	2.7 W/m ² (0.25 W/ft ²)	4.3 W/m ² (0.40 W/ft ²)	4.3 W/m ² (0.40 W/ft ²)
Loading docks	No allowance	5.4 W/m ² (0.50 W/ft ²)	5.4 W/m ² (0.50 W/ft ²)	5.4 W/m ² (0.50 W/ft ²)	5.4 W/m ² (0.50 W/ft ²)
Sales Canopies					
Free standing and attached	No allowance	4.3 W/m ² (0.40 W/ft ²)	4.3 W/m ² (0.4 W/ft ²)	6.5 W/m ² (0.60 W/ft ²)	7.5 W/m ² (0.70 W/ft ²)
Outdoor Sales					
Open areas (including vehicle sales lots)	No allowance	6.5 W/m ² (0.60 W/ft ²)	6.5 W/m ² (0.60 W/ft ²)	6.5 W/m ² (0.60 W/ft ²)	6.5 W/m ² (0.60 W/ft ²)
Street frontage for vehicle sales lots in addition to "open area" allowance	No allowance	No allowance	23 W/m (7 W/ft)	23 W/m (7 W/ft)	69 W/m (21 W/ft)
Column 1	2	3	4	5	6

TABLE SB 9.4.2-2-2017 (Cont'd)
(Supersedes Table 9.4.2-2 in 2013 ANSI/ASHRAE/IES 90.1)
Individual Lighting Power Allowances for Building Exteriors
 Forming Part of Sentences 1.1.1.9.(5) and (6)

	Zone 0	Zone 1	Zone 2	Zone 3	Zone 4
Base Site Allowance (base allowance may be used in tradable or non-tradable surfaces)					
	No allowance	350 W	400 W	500 W	900 W
Nontradable Surfaces (LPD calculations for the following applications can be used only for the specific application and cannot be traded between surfaces or with other exterior lighting. The following allowances are in addition to any allowance otherwise permitted in the "Tradable Surfaces" section of this table.)					
Building façades (façade lighting)	No allowance	No allowance	1.1 W/m ² (0.10 W/ft ²) for each illuminated wall or surface or 8.2 W/m (2.5 W/ft) for each illuminated wall or surface length	1.6 W/m ² (0.15 W/ft ²) for each illuminated wall or surface or 12.3 W/m (3.75 W/ft) for each illuminated wall or surface length	2.2 W/m ² (0.20 W/ft ²) for each illuminated wall or surface or 16.4 W/m (5.0 W/ft) for each illuminated wall or surface length
Automated teller machines (ATM) and night depositories	No allowance	135 W per location plus 45 W per additional ATM per location	135 W per location plus 45 W per additional ATM per location	135 W per location plus 45 W per additional ATM per location	135 W per location plus 45 W per additional ATM per location
Entrances and gatehouse inspection stations at guarded facilities	No allowance	5.4 W/m ² (0.50 W/ft ²) of covered and uncovered area	5.4 W/m ² (0.50 W/ft ²) of covered and uncovered area	5.4 W/m ² (0.50 W/ft ²) of covered and uncovered area	5.4 W/m ² (0.50 W/ft ²) of covered and uncovered area
Loading areas for law enforcement, fire, ambulance, and other emergency service vehicles	No allowance	3.8 W/m ² (0.35 W/ft ²) of covered and uncovered area	3.8 W/m ² (0.35 W/ft ²) of covered and uncovered area	3.8 W/m ² (0.35 W/ft ²) of covered and uncovered area	3.8 W/m ² (0.35 W/ft ²) of covered and uncovered area
Drive-through windows/doors	No allowance	200 W per drive-through	200 W per drive-through	200 W per drive-through	200 W per drive-through
Parking near 24-hour retail entrances	No allowance	400 W per drive-through	400 W per drive-through	400 W per drive-through	400 W per drive-through
Roadway/parking entry, trail head, and toilet facility, or other locations approved by the authority having jurisdiction.	A single luminaire of 60 W or less may be installed for each roadway/parking entry, trail head, and toilet facility, or other locations approved by the authority having jurisdiction	No allowance	No allowance	No allowance	No allowance
Column 1	2	3	4	5	6

1.1.1.10. Other Equipment

- (1) Section 10.4.1.A shall be added to Section 10 “Other Equipment” of 2013 ANSI/ASHRAE/IES 90.1.

10.4.1.A Electric Motors

- (1) Notwithstanding Section 10.4.1, where the minimum efficiency requirements of an electric motor is covered under an applicable Ontario Energy Efficiency Regulation, it shall meet the requirements of the Ontario Regulation and shall be deemed to be in compliance with Section 10.4.1.
- (2) Section 10.4.5.3 shall be added to Section 10.4.5 “Whole Building Energy Monitoring” of 2013 ANSI/ASHRAE/IES 90.1.

10.4.5.3 The building shall be deemed to comply with Sections 10.4.5.1 and 10.4.5.2, if the building is designed and constructed to facilitate future installation of means to measure and monitor energy use by each energy type described in Section 10.4.5.1. (See Appendix A.)

1.1.1.11. Energy Cost Method

- (1) Section 11.4.1.1.(a.) of 2013 ANSI/ASHRAE/IES 90.1 shall be substituted with the following:
 - a. hour by hour and a minimum of 8760 hours per year.
- (2) Section 11.5.2.(d.) of 2013 ANSI/ASHRAE/IES 90.1 shall be substituted with the following:
 - d. For the purpose of annual energy use simulation, except as provided in (d1.), the peak outdoor air ventilation rates for the proposed and budget building shall be the same and set to the minimum rates required by the applicable ventilation standard based on the proposed building design. Heat recovery shall be modelled for the budget building design in accordance with Section 6.5.6.1.
 - d1. Except where it may be required by Section 6 of 2013 ANSI/ASHRAE/IES 90.1, demand controlled and dedicated ventilation strategies need not be modeled in the budget building.
- (3) Notwithstanding Section 11.5.2.(h.), the budget building fan power may be modeled in accordance with the requirements of G3.1.2.10 of Appendix G, 2013 ANSI/ASHRAE/IES 90.1.
- (4) Notwithstanding footnotes “e” and “f” of Table 11.5.3.A, the budget building water pumps may be modeled in accordance with the requirements of G3.1.3.5 and G3.1.3.10 of Appendix G, 2013 ANSI/ASHRAE/IES 90.1.
- (5) Energy saving credits may be taken for automatic lighting controls that are provided in addition to those required in Section 9.4.1 of 2013 ANSI/ASHRAE/IES 90.1.
- (6) Section 11.4.3.2.A.(1) below shall be added to Section 11.4.3 “Renewable, Recovered and Purchased Energy Rates” of 2013 ANSI/ASHRAE/IES 90.1.

11.4.3.2.A Rates for Energy Supplied Back to the Grid System.

- (1) Where energy generated by an on-site renewable energy source is supplied back to the grid system, for the purpose of Section 11, Energy Cost Budget Method, the rates for the energy supplied back to the grid system shall be assumed to be equal to the rates paid for the same type of purchased energy from the grid system.

Chapter 3

Additional Requirements to the 2015 NECB

Section 1.1. Changes and Additional Requirements

1.1.1. Changes and Additional Requirements to the 2015 NECB

1.1.1.1. Application of Chapter 3

- (1) Where compliance with energy efficiency requirements is achieved in accordance with Clause 1.1.2.1.(1)(b) of Chapter 1, energy efficiency of the *building* is required to conform to the 2015 NECB and this Chapter.
- (2) Notwithstanding Sentence 1.1.1.3.(1) of the 2015 NECB, where the requirements of the *Building Code* or the requirements of this Division are in conflict with the requirements of the 2015 NECB, the requirements of the *Building Code* and the requirements of this Division shall govern.
- (3) In the 2015 NECB, references made to the CCBFC NRCC 53301, “National Building Code of Canada” or CCBFC NRCC 53302, “National Plumbing Code of Canada” are deemed to be references to corresponding provisions of the *Building Code*.

1.1.1.2. Division A, Part 1 “Compliance” of the 2015 NECB

- (1) Notwithstanding the provisions Sentence 1.1.1.1.(1) of Part 1 of Division A of the 2015 NECB and except as provided in Division 1 and Chapter 1 of Division 3 of this Supplementary Standard, except for *residential occupancies* that are within the scope of Part 9 of Division B of the *Building Code*, and except for farm buildings, the 2015 NECB shall apply to all *buildings*.

1.1.1.3. Division A, Part 2 “Objectives” and Part 3 “Functional Statements” of the 2015 NECB

- (1) In addition to objectives and functional statements set out in Parts 2 and 3 of Division A of the 2015 NECB, the objectives and functional statements set out in the *Building Code* and attributed to Sentence 12.2.1.2.(2) of Division B of the *Building Code* shall also be the objectives and functional statements of the 2015 NECB.

1.1.1.4. Division B, “Acceptable Solutions” of the 2015 NECB

- (1) Except as provided in this Chapter, the energy efficiency of a *building* shall conform to all requirements of Division B “Acceptable Solutions” of the 2015 NECB and this Chapter.

1.1.1.5. Division C, “Administrative Provisions” of the 2015 NECB

- (1) Division C “Administrative Provisions” of the 2015 NECB shall be substituted with the administrative provisions of the *Building Code Act, 1992* and the administrative provisions of Division C of the *Building Code*.

1.1.1.6. Enhancements to Division B, Part 3 “Building Envelope” of the 2015 NECB

(1) Where *electric space heating* is used in a *building* located in Zone 5, 6, 7A, or 7B, the *building* envelope requirements of Zone 7B of the 2015 NECB shall apply regardless of climatic zone.

(2) Table 3.2.2.2. in Division B of the 2015 NECB shall be substituted with the following:

Table SB 3.2.2.2.
(Supersedes Table 3.2.2.2. in the 2015 NECB)
Overall Thermal Transmittance of Above-Ground Opaque Building Assemblies
Forming Part of Sentences 3.2.2.2.(1) and (2)

Above-Ground Opaque Building Assembly	Heating Degree-Days of <i>Building</i> Location, ⁽¹⁾ in Celsius Degree-Days			
	Zone 5 ⁽²⁾ 3000 to 3999	Zone 6 ⁽²⁾ 4000 to 4999	Zone 7A and 7B ⁽²⁾ 5000 to 6999	Zone 8 ⁽²⁾ ≥ 7000
	Maximum <i>Overall Thermal Transmittance</i> , in W/(m ² ·K)			
Walls	0.278	0.247	0.210	0.183
Roofs	0.156	0.156	0.138	0.121
Floors	0.183	0.183	0.162	0.142

Notes to Table SB 3.2.2.2.:

(1) See Sentence 1.1.4.1.(1).

(2) See Appendix A.

(3) Table 3.2.2.3. in Division B of the 2015 NECB shall be substituted with the following:

Table SB 3.2.2.3.
(Supersedes Table 3.2.2.3. in the 2015 NECB)
Overall Thermal Transmittance of Fenestration
Forming Part of Sentences 3.2.2.3.(2) to (4)

Component	Heating Degree-Days of <i>Building</i> Location, ⁽¹⁾ in Celsius Degree-Days			
	Zone 5 ⁽²⁾ 3000 to 3999	Zone 6 ⁽²⁾ 4000 to 4999	Zone 7A and 7B ⁽²⁾ 5000 to 6999	Zone 8 ⁽²⁾ ≥ 7000
	Maximum <i>Overall Thermal Transmittance</i> , in W/(m ² ·K)			
All Fenestration	1.9	1.9	1.9	1.4

Notes to Table SB 3.2.2.3.:

(1) See Sentence 1.1.4.1.(1).

(2) See A-Table 3.2.2.2. in Appendix A.

(4) Sentence (5) shall be added to Article 3.2.2.3. of Division B of the 2015 NECB.

3.2.2.3. Thermal Characteristics of Fenestration

(5) The maximum solar heat gain coefficient of fenestration shall comply with Table 3.2.2.3.A.

Table 3.2.2.3.A.
Maximum Solar Heat Gain Coefficients
 Forming Part of Sentence 3.2.2.3.(4)

Climatic Zone	Zone 5		Zone 6		Zone 7A and 7B		Zone 8	
	Residential	Others	Residential	Others	Residential	Others	Residential	Others
Vertical Fenestration, SHGC	0.40	0.40	0.40	0.40	0.45	0.45	NR	NR
Skylights, SHGC	0.40	0.40	0.40	0.40	NR	NR	NR	NR
Column 1	2	3	4	5	6	7	8	9

Notes to Table 3.2.2.3.A.:

NR = No requirement

- (5) Table 3.2.2.4. in Division B of the 2015 NECB shall be substituted with the following:

Table SB 3.2.2.4.
 (Supersedes Table 3.2.2.4. in the 2015 NECB)
Overall Thermal Transmittance of Doors
 Forming Part of Sentences 3.2.2.4.(1) and (2)

Component	Heating Degree-Days of <i>Building</i> Location, ⁽¹⁾ in Celsius Degree-Days			
	Zone 5 ⁽²⁾ 3000 to 3999	Zone 6 ⁽²⁾ 4000 to 4999	Zone 7A and 7B ⁽²⁾ 5000 to 6999	Zone 8 ⁽²⁾ ≥ 7000
	Maximum <i>Overall Thermal Transmittance</i> , in W/(m ² ·K)			
All Doors	1.9	1.9	1.9	1.4

Notes to Table SB 3.2.2.4.:

(1) See Sentence 1.1.4.1.(1).

(2) See A-Table 3.2.2.2. in Appendix A.

(6) Notwithstanding Sentence 3.3.1.2.(2) of Division B of the 2015 NECB, where Section 3.3. Trade-Off Path of the 2015 NECB is used and where the vertical total fenestration and door area to gross wall area ratio (FDWR) of the proposed building is less than the maximum FDWR permitted in Sentence 3.2.1.4.(1) of Division B of the 2015 NECB, the FDWR of the reference building shall be equal to the proposed building.

(7) Notwithstanding of Sentence 3.3.1.2.(2) of Division B of the 2015 NECB, where Section 3.3. Trade-Off Path of the 2015 NECB is used and where the total skylight area to gross roof area ratio of the proposed building is less than the maximum ratio permitted in Sentence 3.2.1.4.(2) of Division B of the 2015 NECB, the total skylight area to gross roof area ratio of the reference building shall be equal to the proposed building.

(8) Thermal characteristics of fenestration are permitted to be determined in conformance with;

- (a) CAN/CSA-A440.2, “Fenestration Energy Performance”, or
- (b) NFRC 100, “Procedure for Determining Fenestration Product U-factors” and NFRC 200, “Procedure for Determining Fenestration Product Solar Heat Gain Coefficient and Visible Transmittance at Normal Incidence”.

1.1.1.7. Enhancements to Division B, Part 4 “Lighting” of the 2015 NECB

- (1) The calculation of interior lighting power allowance shall be based on the lighting power densities given in Table SB 4.2.1.5.–2017 or Table SB 4.2.1.6.–2017 of this Chapter.
- (2) Except as provided in Sentence (4), for the purpose of Sentence (1), any reference to Table 4.2.1.5. and the lighting power densities contained in Table 4.2.1.6. of Division B of the 2015 NECB, shall be deemed to be a reference to Table SB 4.2.1.5.–2017 and lighting power densities in Table SB 4.2.1.6.–2017 of this Chapter.
- (3) Lighting power densities listed in Table SB 4.2.1.5.–2017 and Table SB 4.2.1.6.–2017 of this Chapter shall supersede the lighting power densities listed in Table 4.2.1.5. and Table 4.2.1.6. of Division B of the 2015 NECB.
- (4) Minimum lighting control requirements in Table 4.2.1.6. of the 2015 NECB shall apply.

Table SB 4.2.1.5.-2017
 Lighting Power Density by Building Type for Use with the Building Area Method
 Forming Part of Sentences 4.2.1.5.(1), (4) and (5)

Building Area Type	Lighting Power Density, W/m ² (W/ft ²)
Automotive Facility	7.6 (0.71)
Convention Centre	8.2 (0.76)
Courthouse	9.7 (0.90)
Dining	
Bar Lounge / Leisure	9.7 (0.90)
Cafeteria / Fast Food	8.5 (0.79)
Family	8.4 (0.78)
Dormitory	6.6 (0.61)
Exercise Centre	7.0 (0.65)
Fire Station	5.7 (0.53)
Gymnasium	7.3 (0.68)
Health-Care Clinic	8.8 (0.82)
Hospital	11.3 (1.05)
Hotel	8.1 (0.75)
Library	8.4 (0.78)
Manufacturing Facility	9.7 (0.90)
Motel	8.1 (0.75)
Motion Picture Theatre	8.9 (0.83)
Multi-Unit Residential Building	7.3 (0.68)
Museum	11.4 (1.06)
Office	8.5 (0.79)
Storage Garage	1.6 (0.15)
Penitentiary	8.1 (0.75)
Performing Arts Theatre	12.7 (1.18)
Police Station	8.6 (0.80)
Post Office	7.2 (0.67)
Religious Building	10.1 (0.94)
Retail	11.4 (1.06)
School / University	8.7 (0.81)
Sports Arena	9.4 (0.87)
Town Hall	8.6 (0.80)
Transportation	6.6 (0.61)
Warehouse	5.2 (0.48)
Workshop	9.7 (0.90)
Column 1	2

Table SB 4.2.1.6.-2017⁽¹⁾
 Lighting Power Density Using the Space-by-Space Method
 Forming Part of Sentence 4.2.1.6.(1)

Common Space Types	Lighting Power Density, W/m ² (W/ft ²)
Atrium	
< 6 m in height	1.06 per m in height (0.03 per ft in height)
≥ 6 m and ≤ 12 m in height	1.06 per m in height (0.03 per ft in height)
> 12 m in height	4.31 + 0.71 per m in height (0.40 + 0.02 per ft in height)
Audience / Seating Area-Permanent	
For Auditorium	6.8 (0.63)
For Convention Centre	8.8 (0.82)
For Gymnasium	7.0 (0.65)
For Motion Picture Theatre	12.3 (1.14)
For Penitentiary	3.0 (0.28)
For Performing Arts Theatre	21.8 (2.03)
For Religious Buildings	16.5 (1.53)
For Sports Arena	4.6 (0.43)
Other	4.6 (0.43)
Banking Activity Area and Offices	9.3 (0.86)
Classroom / Lecture / Training	
For Penitentiary	14.4 (1.34)
Other	10.3 (0.96)
Computer / Server Room	14.3 (1.33)
Conference / Meeting/Multi-Purpose	11.5 (1.07)
Confinement Cell	8.7 (0.81)
Copy / Print Room	6.0 (0.56)
Corridor / Transition Area	
For space designed to ANSI/IES RP- 28 ⁽²⁾ (and used primarily by residents)	9.9 (0.92)
For Hospital	9.9 (0.92)
For Manufacturing Facility	3.1 (0.29)
Other	7.1 (0.66)
Courtroom	15.0 (1.39)
Dining Area	
For Bar Lounge / Leisure Dining	10.0 (0.93)
For Cafeteria / Fast Food Dining	6.8 (0.63)
For Family Dining	7.6 (0.71)
For space designed to ANSI/IES RP-28 ⁽²⁾ (and used primarily by residents)	21.5 (2.00)
For Penitentiary	10.3 (0.96)
Other	6.8 (0.63)
Column 1	2

Table SB 4.2.1.6.–2017 (Cont'd)
 Lighting Power Density Using the Space-by-Space Method
 Forming Part of Sentence 4.2.1.6.(1)

Building-Specific Space Types	Lighting Power Density, W/m ² (W/ft ²)
Dressing / Fitting Room For Performing Arts Theatre	6.6 (0.61)
Electrical / Mechanical Room	4.6 (0.43)
Emergency Vehicle Garage	4.4 (0.41)
Food Preparation Area	11.4 (1.06)
Guest Room	8.3 (0.77)
Laboratory	
For Classrooms	12.9 (1.20)
Other	15.6 (1.45)
Laundry / Washing Area	4.6 (0.43)
Loading Dock, Interior	6.2 (0.58)
Lobby	
For space designed to ANSI/IES RP-28 ⁽²⁾ (and used primarily by residents)	21.8 (2.03)
For Elevator	7.3 (0.68)
For Hotel	11.4 (1.06)
For Motion Picture Theatre	4.8 (0.45)
For Performing Arts Theatre	18.3 (1.70)
Other	10.8 (1.00)
Locker Room	5.2 (0.48)
Lounge / Break Room	
For Healthcare Facility	8.4 (0.78)
Other	6.7 (0.62)
Office	
Enclosed	10.0 (0.93)
Open Plan	8.7 (0.81)
Storage Garage, Interior	1.5 (0.14)
Pharmacy Area	14.4 (1.34)
Sales Area	13.1 (1.22)
Seating Area, General	4.6 (0.43)
Stairway	6.2 (0.58)
Storage Room $\geq 5 \text{ m}^2$ and $< 100 \text{ m}^2$	6.8 (0.63)
Storage Room $< 5 \text{ m}^2$	10.4 (0.97)
Vehicular Maintenance Area	6.0 (0.56)
Washroom	
For care occupancy designed to ANSI/IES RP-28 ⁽²⁾ (and used primarily by residents)	13.1 (1.22)
Other	9.1 (0.85)
Workshop	12.3 (1.14)
Column 1	2

Table SB 4.2.1.6.–2017 (Cont'd)
 Lighting Power Density Using the Space-by-Space Method
 Forming Part of Sentence 4.2.1.6.(1)

Building-Specific Space Types	Lighting Power Density, W/m ² (W/ft ²)
Care occupancy designed to ANSI/IES RP-28 ⁽²⁾	
For Chapel (used primarily by residents) 23.811.4	11.4 (1.06)
For Recreation Room (used primarily by residents)	19.4 (1.80)
Convention Centre	
Exhibit Space	9.5 (0.88)
Dormitory	
Living Quarters	5.8 (0.54)
Fire Station	
Sleeping Quarters	2.2 (0.20)
Gymnasium / Fitness Centre	
Exercise Area	5.4 (0.50)
Playing Area	8.8 (0.82)
Healthcare Facility	
Exam / Treatment Room	18.1 (1.68)
Medical Supply Room	5.8 (0.54)
Nursery	10.8 (1.00)
Nurses' Station	8.7 (0.81)
Operating Room	23.4 (2.17)
Patient Room	6.7 (0.62)
Physical Therapy	9.0 (0.84)
Imaging Room	11.4 (1.06)
Recovery	11.1 (1.03)
Library	
Reading Area	8.8 (0.82)
Stacks	12.9 (1.20)
Manufacturing Facility	
Detailed Manufacturing Area	10.0 (0.93)
Equipment Room	7.0 (0.65)
Extra High Bay (> 15 m floor to ceiling height)	11.3 (1.05)
High Bay (7.5 m to 15 m floor to ceiling height)	8.1 (0.75)
Low Bay (< 7.5 m floor to ceiling height)	10.3 (0.96)
Column 1	2

Table SB 4.2.1.6.-2017 (Cont'd)
Lighting Power Density Using the Space-by-Space Method
Forming Part of Sentence 4.2.1.6.(1)

Building-Specific Space Types	Lighting Power Density, W/m ² (W/ft ²)
Museum	
General Exhibition	11.3 (1.05)
Restoration	9.2 (0.85)
Post Office	7.3 (0.68)
Sorting Area	
Religious Building	
Fellowship Hall	5.9 (0.55)
Worship / Pulpit / Choir	16.5 (1.53)
Retail Facilities	
Dressing / Fitting Room	5.4 (0.50)
Mall Concourse	9.7 (0.90)
Sports Arena – Playing Area	
Class IV Facility	12.2 (1.13)
Class III Facility	18.3 (1.70)
Class II Facility	21.1 (1.96)
Class I Facility	26.6 (2.47)
Transportation Facility	
Baggage / Carousel Area	4.8 (0.45)
Airport Concourse	3.3 (0.31)
Terminal Ticket Counter	6.7 (0.62)
Warehouse	
Small, Hand-Carried Items	7.4 (0.69)
Medium To Bulky, Palletized Items	3.8 (0.35)
Column 1	2

Notes to Table SB 4.2.1.6.-2017:

- (1) Terms shall have the same meanings as they have in 2015 NECB or Chapter (2).
- (2) BSR/IES RP-28-16, "Lighting and the Visual Environment for Seniors and the Low Vision Population".

(5) The calculation of exterior lighting power allowance shall be based on Table SB 4.2.3.1.-B–2017, Table SB 4.2.3.1.-C–2017 and Table SB 4.2.3.1.-D–2017 of this Chapter.

(6) Lighting power allowances listed in Table SB 4.2.3.1.-B–2017, Table SB 4.2.3.1.-C–2017 and Table SB 4.2.3.1.-D–2017 of this Chapter shall supersede the lighting power allowances listed in Table 4.2.3.1.-B, Table 4.2.3.1.-C and Table 4.2.3.1.-D of the 2015 NECB, respectively.

TABLE SB 4.2.3.1.-B-2017
 (Supersedes Table 4.2.3.1.-B in the 2015 NECB)
Basic Site Allowances for Exterior Lighting
 Forming Part of Sentences 4.2.3.1.(2) and (3)

Basic Site Allowance According to Lighting Zone				
Zone 0	Zone 1	Zone 2	Zone 3	Zone 4
No allowance	350 W	400 W	500 W	900 W
Column 1	2	3	4	5

TABLE SB 4.2.3.1.-C-2017
 (Supersedes Table 4.2.3.1.-C in the 2015 NECB)
Lighting Power Allowances for Specific Building Exterior Applications
 Forming Part of Sentences 4.2.3.1.(3) and (4)

Exterior Application	Zone 0	Zone 1	Zone 2	Zone 3	Zone 4
Building façades (façade lighting)	No allowance	No allowance	1.1 W/m ² (0.10 W/ft ²) for each illuminated wall or surface or 8.2 W/m (2.5 W/ft) for each illuminated wall or surface length	1.6 W/m ² (0.15 W/ft ²) for each illuminated wall or surface or 12.3 W/m (3.75 W/ft) for each illuminated wall or surface length	2.2 W/m ² (0.20 W/ft ²) for each illuminated wall or surface or 16.4 W/m (5.0 W/ft) for each illuminated wall or surface length
Automated teller machines (ATM) and night depositories	No allowance	135 W per location plus 45 W per additional ATM per location	135 W per location plus 45 W per additional ATM per location	135 W per location plus 45 W per additional ATM per location	135 W per location plus 45 W per additional ATM per location
Entrances and gatehouse inspection stations at guarded facilities	No allowance	5.4 W/m ² (0.50 W/ft ²) of covered and uncovered area	5.4 W/m ² (0.50 W/ft ²) of covered and uncovered area	5.4 W/m ² (0.50 W/ft ²) of covered and uncovered area	5.4 W/m ² (0.50 W/ft ²) of covered and uncovered area
Loading areas for law enforcement, fire, ambulance, and other emergency service vehicles	No allowance	3.8 W/m ² (0.35 W/ft ²) of covered and uncovered area	3.8 W/m ² (0.35 W/ft ²) of covered and uncovered area	3.8 W/m ² (0.35 W/ft ²) of covered and uncovered area	3.8 W/m ² (0.35 W/ft ²) of covered and uncovered area
Drive-up windows/doors	No allowance	200 W per drive-through	200 W per drive-through	200 W per drive-through	200 W per drive-through
Parking near 24-hour retail entrances	No allowance	400 W per drive-through	400 W per drive-through	400 W per drive-through	400 W per drive-through
Roadway/parking entry, trail head, and toilet facility, or other locations approved by the authority having jurisdiction.	A single luminaire of 60 W or less may be installed for each roadway/parking entry, trail head, and toilet facility, or other locations approved by the authority having jurisdiction.	No allowance	No allowance	No allowance	No allowance
Column 1	2	3	4	5	6

TABLE SB 4.2.3.1.-D-2017
 (Supersedes Table 4.2.3.1.-D in the 2015 NECB)
Lighting Power Allowances for General Building Exterior Applications
 Forming Part of Sentence 4.2.3.1.(4)

Exterior Application	Lighting Power Allowances According to Lighting Zone				
	Zone 0	Zone 1	Zone 2	Zone 3	Zone 4
Uncovered Parking Areas					
Parking areas and drives	No allowance	0.32 W/m ² (0.03 W/ft ²)	0.43 W/m ² (0.04 W/ft ²)	0.65 W/m ² (0.06 W/ft ²)	0.86 W/m ² (0.08 W/ft ²)
Building Grounds					
Walkways less than 3 m (10 ft) wide	No allowance	1.6 W/m (0.50 W/ft)	1.6 W/m (0.50 W/ft)	2.0 W/m (0.60 W/ft)	2.3 W/m (0.70 W/ft)
Walkways 3 m (10 ft) wide or greater	No allowance	1.1 W/m ² (0.10 W/ft ²)	1.1 W/m ² (0.10 W/ft ²)	1.2 W/m ² (0.11 W/ft ²)	1.5 W/m ² (0.14 W/ft ²)
Plaza areas	No allowance	1.1 W/m ² (0.10 W/ft ²)	1.1 W/m ² (0.10 W/ft ²)	1.2 W/m ² (0.11 W/ft ²)	1.5 W/m ² (0.14 W/ft ²)
Stairways	No allowance	6.5 W/m ² (0.60 W/ft ²)	7.5 W/m ² (0.70 W/ft ²)	7.5 W/m ² (0.70 W/ft ²)	7.5 W/m ² (0.70 W/ft ²)
Pedestrian Tunnels	No allowance	1.3 W/m ² (0.12 W/ft ²)	1.3 W/m ² (0.12 W/ft ²)	1.5 W/m ² (0.14 W/ft ²)	2.3 W/m ² (0.21 W/ft ²)
Landscaping	No allowance	0.32 W/m ² (0.03 W/ft ²)	0.43 W/m ² (0.04 W/ft ²)	0.43 W/m ² (0.04 W/ft ²)	0.43 W/m ² (0.04 W/ft ²)
Building Entrances, Exits, and Loading Docks					
Pedestrian and vehicular entrances and exits	No allowance	46 W/m (14 W/ft) of door width	46 W/m (14 W/ft) of door width	69 W/m (21 W/ft) of door width	69 W/m (21 W/ft) of door width
Entry canopies	No allowance	2.1 W/m ² (0.20 W/ft ²)	2.7 W/m ² (0.25 W/ft ²)	4.3 W/m ² (0.40 W/ft ²)	4.3 W/m ² (0.40 W/ft ²)
Loading docks	No allowance	5.4 W/m ² (0.50 W/ft ²)	5.4 W/m ² (0.50 W/ft ²)	5.4 W/m ² (0.50 W/ft ²)	5.4 W/m ² (0.50 W/ft ²)
Sales Canopies					
Free standing and attached	No allowance	4.3 W/m ² (0.40 W/ft ²)	4.3 W/m ² (0.4 W/ft ²)	6.5 W/m ² (0.60 W/ft ²)	7.5 W/m ² (0.70 W/ft ²)
Outdoor Sales					
Open areas (including vehicle sales lots)	No allowance	6.5 W/m ² (0.60 W/ft ²)	6.5 W/m ² (0.60 W/ft ²)	6.5 W/m ² (0.60 W/ft ²)	6.5 W/m ² (0.60 W/ft ²)
Street frontage for vehicle sales lots in addition to "open area" allowance	No allowance	No allowance	23 W/m (7 W/ft)	23 W/m (7 W/ft)	69 W/m (21 W/ft)
Column 1	2	3	4	5	6

1.1.1.8. Enhancements to Division B, Part 5 “Heating, Ventilating and Air-Conditioning Systems” of the 2015 NECB

(1) Article 5.2.10.1. in Division B of the 2015 NECB shall be replaced with the following:

5.2.10.1. Heat-Recovery Systems

- (1) Except as provided in Sentences (3) and (4), each exhaust air system shall have an energy recovery system when the system's supply airflow rate exceeds the value listed in Tables SB 5.2.10.1.A–2017 and SB 5.2.10.1.B–2017, based on the operation, climate zone and percentage of outdoor airflow rate at design conditions.
- (2) Heat recovered in accordance with Sentence (1) shall be used in *building* systems.
- (3) The systems need not comply with Sentence (1), where the system
 - (a) is a specialized exhaust system, such as one that is used to exhaust smoke, grease-laden vapours, or toxic, flammable, paint, or corrosive fumes or dust,
 - (b) serves spaces that are not cooled and are heated to less than 16°C,
 - (c) is designed in such a way that the largest source of air exhausted at a single location at the building exterior is less than 75% of the design outdoor airflow rate.
- (4) Dwelling units shall be equipped with heat recovery systems in accordance with Article 5.2.10.4. of the 2015 NECB.

Table SB 5.2.10.1.A–2017
 Exhaust Air Energy Recovery Requirements for Ventilation Systems Operating Less than 8000 Hours per Year
 Forming Part of Sentence 5.2.10.1.(1)

Climate Zone	Percent of Outdoor Air at Full Design Airflow Rate							
	≥ 10% and < 20%	≥ 20% and < 30%	≥ 30% and < 40%	≥ 40% and < 50%	≥ 50% and < 60%	≥ 60% and < 70%	≥ 70% and < 80%	≥ 80%
	Design Supply Fan Airflow Rate (L/s)							
5	≥ 12271	≥ 7551	≥ 2596	≥ 2124	≥ 1652	≥ 944	≥ 472	≥ 0
6	≥ 12271	≥ 7551	≥ 2596	≥ 2124	≥ 1652	≥ 944	≥ 472	≥ 0
7A & 7B	≥ 2124	≥ 1888	≥ 1180	≥ 472	≥ 0	≥ 0	≥ 0	≥ 0
8	≥ 2124	≥ 1888	≥ 1180	≥ 472	≥ 0	≥ 0	≥ 0	≥ 0
Col. 1	2	3	4	5	6	7	8	9

Table SB 5.2.10.1.B–2017
 Exhaust Air Energy Recovery Requirements for Ventilation Systems Operating Greater than or Equal to 8000 Hours per Year
 Forming Part of Sentence 5.2.10.1.(1)

Climate Zone	Percent of Outdoor Air at Full Design Airflow Rate							
	≥ 10% and < 20%	≥ 20% and < 30%	≥ 30% and < 40%	≥ 40% and < 50%	≥ 50% and < 60%	≥ 60% and < 70%	≥ 70% and < 80%	≥ 80%
	Design Supply Fan Airflow Rate (L/s)							
All Zones	> 0	> 0	> 0	> 0	> 0	> 0	> 0	> 0
Col. 1	2	3	4	5	6	7	8	9

- (5) Energy recovery systems required by Sentence (1) shall have at least 55% energy recovery effectiveness determined as a change in enthalpy of the outdoor air supply equal to 55% of the difference between the outdoor air and return air enthalpies at design conditions.
 - (6) At airflow rates not less than the system design capacity, the energy recovery effectiveness of an energy recovery apparatus referred to in Sentence (1) shall be determined in conformance with
 - (a) the test method described in ANSI/AHRI 1060-2009, “Performance Rating of Air-to-Air Exchangers for Energy Recovery Ventilation”,
 - (b) the test method described in CSA C439-09 “Standard Laboratory Methods of Test for Rating the performance of Heat/Energy-Recovery Ventilators”, or
 - (c) the test method described in ASHRAE 84-2008, “Method of Testing Air-to-Air Heat/Energy Exchangers”.
 - (7) Provisions shall be made to bypass or control the energy recovery system to permit air economizer operation as required by Article 5.2.2.8.
- (2) Sentence 5.2.11.5.(3) and its reference in Sentence 5.2.11.5.(1) in Division B of the 2015 NECB shall be deleted.
- (3) In addition to Table 5.2.12.1. in the 2015 NECB, the minimum equipment efficiency of a gas-fired boiler shall comply with the value required in Table SB 5.2.12.1.A–2017.

Table SB 5.2.12.1.A–2017
Minimum Equipment Efficiency for Gas Boilers
 Forming Part of Sentence 5.2.12.1.(1)

Equipment	Heating Capacity, kW (Btu/h)	Performance Required
Gas boilers, hot water	< 88 (< 300,000)	90% AFUE
	≥ 88 and < 733 (≥ 300,000 and < 2,500,000)	90% E _t
Column 1	2	3

1.1.1.9. Enhancements to Division B, Part 6 “Service Water Systems” of the 2015 NECB

- (1) In addition to Table 6.2.2.1. in the 2015 NECB, a gas-fired storage water heater with an input capacity of 22 kW or less shall comply with Table SB 6.2.2.1.A–2017.
- (2) Except where 25% of the annual service water heating requirement is provided by site-recovered energy and except for water heaters installed in individual *dwelling units*, where a service hot water system has a total installed gas water heating input capacity of 293 kW or greater, the gas service water heating equipment shall have a minimum thermal efficiency (E_t) of 90%.

Table SB 6.2.2.1.A –2017
Minimum Equipment Efficiency for Gas Water Heaters
 Forming Part of Sentence 6.2.2.1.(1)

Component	Input, kW (Btu/h)	Performance Requirement
Gas water heaters	≤ 22 (≤ 75,000)	0.7-0.00189V (V in U.S.gallons) EF 0.7-0.0005V (V in litres) EF
Column 1	2	3

1.1.1.10. Enhancements to Division B, Part 7 “Electrical Power Systems and Motors” of the 2015 NECB (See Appendix A.)

- (1) Article 7.2.1.1. of Division B of the 2015 NECB shall be replaced with the following:

7.2.1.1. Facilitation of Monitoring

- (1) Except as provided in Sentence (3), the building shall be designed and constructed to facilitate future installation of means to measure and monitor the electrical consumption of each of the following separately:
- (a) total electrical energy,
 - (b) HVAC systems,
 - (c) interior lighting,
 - (d) exterior lighting, and
 - (e) receptacle circuits.
- (2) Except as provided in Sentence (3), the electrical distribution systems of buildings with tenants or dwelling units shall be designed and constructed to facilitate future installation of means to measure and monitor the electrical consumption of the total building and of each individual tenant or dwelling unit, excluding shared systems.
- (3) The following buildings and electrical energy end-uses need not meet the requirements of Sentence (1):
- (a) buildings with a floor area of less than 2320 m²,
 - (b) individual tenant spaces with floor areas of less than 930 m²,
 - (c) residential building with less than 930 m² of common area, and
 - (d) critical circuit and Equipment branches in health care facilities.

- (2) Sentence (2) shall be added to Article 7.2.4.1. of Division B of the 2015 NECB.

7.2.4.1. Efficiency

- (2) Notwithstanding Sentence (1), where the minimum efficiency requirements of an electric motor is covered under an applicable Ontario Energy Efficiency Regulation, it shall meet the requirements of the Ontario Regulation and shall be deemed to be in compliance with the requirements of Sentence (1).

1.1.1.11. Whole Building Energy Monitoring (See Appendix A.)

- (1) The *building* shall be designed and constructed to facilitate future installation of means to measure and monitor energy consumption of the following types of energy supplied by an energy provider or a plant that is not within the *building*:

- (a) natural gas,
- (b) fuel oil,
- (c) propane,
- (d) steam,
- (e) chilled water, and
- (f) hot water.

1.1.1.12. Enhancements to Division B, Part 8 “Building Energy Performance Compliance Path” of the 2015 NECB

- (1) Sentences (9) and (10) shall be added to Article 8.4.4.3. of Division B of the 2015 NECB.

8.4.4.3. Building Envelope Components

(9) Where the vertical total fenestration and door area to gross wall area ratio (FDWR) of the proposed building is less than the maximum FDWR permitted in Sentence 3.2.1.4.(1), the FDWR of the reference building shall be equal to the proposed building.

(10) Where the total skylight area to gross roof area ratio of the proposed building is less than the maximum ratio permitted in Sentence 3.2.1.4.(2), the total skylight area to gross roof area ratio of the reference building shall be equal to the proposed building.

Division 4

Buildings of Non-Residential Occupancy Within the Scope of Part 9

(Applies to construction for which a permit has been applied for before January 1, 2017)

1.1.	Buildings of Non-Residential Occupancy	
1.1.1.	Buildings of Non-Residential Occupancy.....	83

Division 4

Buildings of Non-Residential Occupancy Within the Scope of Part 9

Section 1.1. Buildings of Non-Residential Occupancy

1.1.1. Buildings of Non-Residential Occupancy

1.1.1.1. Application

(1) Except as provided in Sentences 2 and (3), this Division applies to the energy efficiency of *buildings* or parts of *buildings* where the *building*

- (a) is within the scope of Part 9 of Division B of the *Building Code*,
- (b) does not contain a *residential occupancy*,
- (c) does not use *electric space heating*, and
- (d) is intended for occupancy on a continuing basis during the winter months.

(2) Where the ratio of the gross area of fenestration to the gross area of exterior wall measured from grade to the top of the most upper ceiling exceeds 40%, or the ratio of the gross skylight areas to gross ceiling area exceeds 5%, the *building* envelope shall comply with Article 1.1.2.1. of Chapter 1 of Division 2.

(3) *Buildings* are exempt from compliance with this Division where they meet the exemptions described in Article 1.2.1.1. of Chapter 1 of Division 2.

1.1.1.2. Building Envelope Requirements

(1) Except as permitted in Sentence (2), the exterior *building* envelope shall comply with the requirements of Table 1.1.1.2.

(2) Except for doors, the opaque surfaces shall comply with

- (a) minimum RSI value of the added insulation in framing cavities and continuous insulation required in Table 1.1.1.2.,
or
- (b) maximum overall thermal transmittance U-value for the entire assembly required in Table 1.1.1.2., where U-value is provided.

(3) Where the top of a *foundation* wall is less than 1 200 mm above the adjoining ground level, those portions of the *foundation* wall that are above ground may be insulated to the level required for the below grade portion of the *foundation* wall.

(4) Except for swinging glass doors, the minimum thermal resistance of doors that separate heated space from unheated space shall be not less than RSI 0.7 (R-4).

Table 1.1.1.2.
Building Envelope Requirements Based on Degree-Day Zones⁽¹⁾ (SI)
 Forming Part of Sentences 1.1.1.2.(1) and (2)

Opaque Elements	Zone 1 Less Than 5000 Degree-Days		Zone 2 5000 or More Degree-Days	
	Assembly Max. U-Value ⁽¹⁾	Insulation Min. RSI-Value	Assembly Max. U-Value ⁽¹⁾	Insulation Min. RSI-Value
Roofs				
Without Attic Space-Insulation Above Deck	U-0.181	5.28 ci	U-0.158	6.16 ci
With Attic Space and Other	U-0.119	8.8	U-0.096	10.56
Walls, Above Grade				
Above Grade Walls	U-0.312	2.28 + 1.76 ci	U-0.312	2.28 + 1.76 ci
Wall, Below Grade				
Below Grade Wall	C-0.522 ⁽²⁾	1.76 ci	C-0.522 ⁽²⁾	1.76 ci
Exposed Floors				
Lightweight Framing	U-0.181	6.69 ⁽³⁾	U-0.181	6.69 ⁽³⁾
Mass	U-0.323	2.57 ci	U-0.244	3.52 ci
Slab-On-Grade Floors (perimeter + below slab)				
Unheated		2.64 for 600 mm		2.64 for 600 mm + 0.88 ci below
Heated		2.64 for 900 mm + 0.88 ci below		3.52 for 900 mm + 0.88 ci below
Fenestration	Assembly Max. U-Value ⁽¹⁾	Assembly Max. SHGC	Assembly Max. U-Value ⁽¹⁾	Assembly Max. SHGC
Vertical Fenestration, 0% - 40% of Wall				
Windows	U-1.99	0.40	U-1.70	0.45
Skylight with Curb, % of Roof				
0% - 5.0%	U-3.92	0.49	U-3.92	0.50
Skylight without curb, % of Roof				
0% - 5.0%	U-2.56	0.46	U-2.56	0.46
Column 1	2	3	4	5

Notes to Table 1.1.1.2.:

The following definitions apply: ci = continuous insulation

(1) The overall thermal transmittance value of the entire assembly, includes air films.

(2) C-Value is overall thermal conductance of the assembly but it does not include soil or air films.

(3) Where the floor framing depth is 254 mm or less, the insulation is permitted to meet a minimum RSI-Value of 5.28.

Table 1.1.1.2.
Building Envelope Requirements Based on Degree-Day Zones⁽¹⁾ (I-P)
 Forming Part of Sentences 1.1.1.2.(1) and (2)

Opaque Elements	Zone 1 Less Than 5000 Degree-Days		Zone 2 5000 or More Degree-Days	
	Assembly Max. U-Value ⁽¹⁾	Insulation Min. R-Value	Assembly Max. U-Value ⁽¹⁾	Insulation Min. R-Value
Roofs				
Without Attic Space-Insulation Above Deck	U-0.032	R-30 ci	U-0.028	R-35 ci
With Attic Space and Other	U-0.021	R-50	U-0.017	R-60
Walls, Above Grade				
Above Grade Walls	U-0.055	R-13 + R-10 ci	U-0.055	R-13 + R-10 ci
Wall, Below Grade				
Below Grade Wall	C-0.092 ⁽²⁾	R-10 ci	C-0.092 ⁽²⁾	R-10 ci
Exposed Floors				
Lightweight Framing	U-0.032	R-38 ⁽³⁾	U-0.032	R-38 ⁽³⁾
Mass	U-0.057	R-14.6 ci	U-0.043	R-20 ci
Slab-On-Grade Floors (perimeter + below slab)				
Unheated		R-15 for 24 in.		R-15 for 24 in. + R-5 ci below
Heated		R-15 for 36 in. + R-5 ci below		R-20 for 36 in. + R-5 ci below
Fenestration	Assembly Max. U-Value ⁽¹⁾	Assembly Max. SHGC	Assembly Max. U-Value ⁽¹⁾	Assembly Max. SHGC
Vertical Fenestration, 0% - 40% of Wall				
Windows	U-0.35	0.40	U-0.30	0.45
Skylight with Curb, % of Roof				
0% - 5.0%	U-0.69	0.49	U-0.69	0.50
Skylight without curb, % of Roof				
0% - 5.0%	U-0.45	0.46	U-0.45	0.46
Column 1	2	3	4	5

Notes to Table 1.1.1.2.:

The following definitions apply: ci = continuous insulation

(1) The overall thermal transmittance value of the entire assembly, includes air films.

(2) C-Value is overall thermal conductance of the assembly but it does not include soil or air films.

(3) Where the floor framing depth is 10 inches or less, the insulation is permitted to meet a minimum R-Value of R-30.

1.1.1.3. Air Infiltration

(1) Where a *building* component or assembly separates interior conditioned space from exterior space, interior space from ground or environmentally dissimilar interior spaces, the component or assembly shall contain an *air barrier system* conforming to the applicable requirements of Part 5 or Section 9.25. of Division B of the *Building Code*.

1.1.1.4. Heating, Ventilating and Air-Conditioning

(1) A heating, ventilating and *air-conditioning* system that serves more than one heating, ventilating and *air-conditioning* zone shall conform to Article 1.1.2.1. of Chapter 1 of Division 2 of this Supplementary Standard.

(2) Sentences (3) to (11) and Article 1.1.1.5. apply to a heating, ventilating and *air-conditioning* system that serves a single heating, ventilating and *air-conditioning* zone.

(3) Heating, ventilating and *air-conditioning* equipment shall conform to the minimum effective values required by Clause 1.1.2.1.(1)(c) of Chapter 1 of Division 2 of this Supplementary Standard.

(4) An *air-conditioning* system with a cooling capacity of 40 kW or more shall have an economizer,

(a) controlled by appropriate high limit shut-off control, and

(b) equipped with either barometric or powered relief sized to prevent excess pressurization of the *building*.

(5) Outdoor air dampers for economizer use shall be provided with blade and jamb seals.

(6) A heat recovery ventilator with a recovery effectiveness of 50% or more at the outside winter design temperature shall be provided where the quantity of the outdoor air supplied to the air duct distribution system is,

(a) more than 1400 L/s, and

(b) more than 70% of the supply air quantity of the system.

(7) Where a heat recovery ventilator is installed, the system shall have provisions to bypass or control the heat recovery ventilator to permit operation of the air economizer.

(8) A heating, ventilating and *air-conditioning* system shall be controlled by a manual changeover or dual setpoint thermostat.

(9) Except for a system requiring continuous operation, a heating, ventilating and *air-conditioning* system that has a cooling or heating capacity greater than 4.4 kW and a supply fan motor rated for more than 0.5 kW shall be provided with a time clock that,

(a) is capable of starting and stopping the system under different schedules for seven different day-types per week,

(b) is capable of retaining programming and time setting during a loss of power for a period of 10 hours or more,

(c) includes an accessible manual override that allows temporary operation of the system for up to two hours,

(d) is capable of temperature setback down to 13°C during off-hours, and

(e) is capable of temperature setup to 32°C during off-hours.

(10) Where separate heating and cooling equipment serves the same temperature zone, thermostats shall be interlocked to prevent simultaneous heating and cooling.

(11) A heating, ventilating and *air-conditioning* system with a design supply air capacity greater than 5000 L/s shall have optimum start controls.

1.1.1.5. Ducts, Plenums and Piping

- (1) A duct or a plenum that is not protected by an insulated exterior wall or that is exposed to an unheated space shall be
 - (a) sealed in accordance with SMACNA, “HVAC Duct Construction Standards - Metal and Flexible”, to minimize air leakage, and
 - (b) insulated to provide a thermal resistance of not less than RSI 1.4.
- (2) A supply or *exhaust duct* or *plenum* that is located in a *conditioned space* shall be sealed in accordance with SMACNA, “HVAC Duct Construction Standards - Metal and Flexible”, to minimize air leakage.
- (3) Except for piping within prefabricated equipment, piping used for steam, hot water heating or cooling shall be insulated in accordance with Table 1.1.1.5.

Table 1.1.1.5.
Minimum Thickness of Pipe Insulation⁽¹⁾
 Forming Part of Sentences 1.1.1.5.(3) and 1.1.1.6.(2)

Use of Pipe	Nominal Pipe Size Not More than 40 mm	Nominal Pipe Size More than 40 mm
	Minimum Pipe Insulation Thickness, mm	Minimum Pipe Insulation Thickness, mm
Steam	40	65
Hot water heating	40	50
Domestic hot water	25	50
Cooling	12	25
Column 1	2	3

Notes to Table 1.1.1.5.:

- (1) Insulation material shall have a thermal conductivity of not more than 0.042 W/(m•°C).
- (4) Insulation exposed to weather shall be protected by a covering such as aluminum, sheet metal, painted canvas or plastic.
- (5) An *exhaust duct* with a design capacity of more than 140 L/s on a heating, ventilating and *air-conditioning* system that does not operate continuously shall be equipped with a gravity or motorized damper that will automatically shut when the system is not in operation.
- (6) An air duct distribution system shall be balanced in the following sequence:
 1. Minimize throttling losses.
 2. If the fan is rated for more than 0.75 kW, adjust the fan speed to meet design flow conditions.
- (7) A hydronic system shall be proportionately balanced to minimize throttling losses.

1.1.1.6. Service Water Heating

- (1) Water heating equipment used solely for heating *potable* water and hot water storage tanks shall meet the minimum efficiency values required by Clause 1.1.2.1.(1)(c) of Chapter 1 of Division 2 of this Supplementary Standard.
- (2) Domestic hot water heating piping shall be insulated in accordance with Table 1.1.1.5. if it is,
 - (a) recirculating system piping,
 - (b) located within the first 2.5 m of outlet piping in a constant temperature non-recirculating storage system,
 - (c) an inlet pipe located between the storage tank and a heat trap in a non-recirculating storage system, or
 - (d) a pipe that is externally heated by methods such as a heat trace or impedance heating.

- (3) A hot water storage tank shall be provided with a temperature control to permit adjustment of the water storage temperature.
- (4) An automatic time switch or other control that can be set to switch off the usage temperature maintenance system during extended periods when hot water is not required shall be installed in a domestic hot water system that is designed to maintain usage temperatures in hot water pipes such as recirculating hot water systems or heat trace.
- (5) If a recirculating pump is used to maintain storage tank water temperature, the pump shall be equipped with a control to limit its operation to a period from the start of the heating cycle to a maximum of five minutes after the end of the heating cycle.
- (6) In a washroom located in a public facility, a device shall be provided to control the maximum temperature of water delivered from a lavatory faucets to not more than 43°C.
- (7) A vertical pipe riser that serves a storage water heater or a storage tank shall have heat traps on both the inlet and outlet piping as close as practical to the tank if,
 - (a) the riser is in a non-recirculating system, and
 - (b) the storage water heater or the storage tank does not have integral heat traps.
- (8) A system that provides both space heating and domestic water heating shall conform to the minimum efficiency values required by Clause 1.1.2.1.(1)(c) of Chapter 1 of Division 2 of this Supplementary Standard.

1.1.1.7. Lighting

- (1) Except as provided in Sentence (2), Articles 1.1.1.8. to 1.1.1.11. apply to,
 - (a) interior spaces of a *building*,
 - (b) exterior *building* features, including facades, illuminated roofs, architectural features, entrances, *exits*, loading docks and illuminated canopies, and
 - (c) exterior *building* ground lighting provided through the *building's* electrical service.
- (2) Articles 1.1.1.8. to 1.1.1.11. do not apply to emergency lighting that is automatically turned off during the normal use of the *building*.
- (3) Except as provided in Sentence (4), luminaires designed for use with one or three linear fluorescent lamps greater than 30 W each shall use two-lamp tandem-wired ballasts in place of single-lamp ballasts when two or more luminaires are in the same space and on the same control device.
- (4) The tandem wiring required by Sentence (3) is not required for,
 - (a) recessed luminaires located more than 3 m apart, measured centre to centre,
 - (b) surface mounted or pendant luminaires that are not continuous,
 - (c) luminaires that use single-lamp high-frequency electronic ballasts,
 - (d) luminaires that use three-lamp high-frequency electronic or three-lamp electromagnetic ballasts, and
 - (e) luminaires on emergency circuits.

1.1.1.8. Interior Lighting

- (1) The interior lighting power allowance for a *building* is the sum of the lighting power allowances, in watts, of all building area types and shall include all permanently installed general, task and furniture lighting systems and luminaires.
- (2) The interior lighting power allowance shall be determined by multiplying the lighting power density given in Table 1.1.1.8. by the gross lighted areas of the building area type.

Table 1.1.1.8.
Interior Lighting Power Densities
Forming Part of Sentence 1.1.1.8.(2)

Building Area Type	Lighting Power Density, W/m ²
Automotive Facility	8.8
Fast Food	10.0
Dormitory	6.6
Health Care Clinic	9.4
Manufacturing Facility	12.0
Office	10.0
Parking Garage	3.0
Police Station without detention quarters / Fire Station	10.0
Post Office	9.4
Retail	15.0
Transportation	8.3
Warehouse	7.0
Workshop	13.0
Column 1	2

- (3) The installed interior lighting power shall not exceed the interior lighting power allowance.
- (4) Except as provided in Sentence (5), the installed interior lighting power shall include all power used by luminaires, including lamps, ballasts, current regulators and control devices.
- (5) The following lighting equipment and applications shall not be considered when determining the installed interior lighting power or the interior lighting power allowance:
- (a) lighting that is integral to equipment or instrumentation and is installed by its manufacturer,
 - (b) lighting specifically designed for use only during medical or dental procedures and lighting integral to medical equipment,
 - (c) lighting that is integral to both open and glass-enclosed refrigerator and freezer cases,
 - (d) lighting that is integral to food warming and food preparation equipment,
 - (e) lighting for plant growth or maintenance,
 - (f) lighting in spaces specifically designed for use by persons with low or no vision,
 - (g) lighting in retail display windows if the display area is enclosed by ceiling-height partitions,
 - (h) lighting in interior spaces that have been specifically designated as a *heritage building*,
 - (i) lighting that is an integral part of advertising or directional signage,
 - (j) *exit* signs,
 - (k) lighting that is displayed for sale, and
 - (l) educational lighting demonstration systems.
- (6) Trade-offs among building area types are permitted provided that the total installed interior lighting power does not exceed the interior lighting power allowance.

1.1.1.9. Interior Lighting Controls

- (1) Except as provided by Sentence (2), interior lighting in a *building* that exceeds 500 m² in *building area* shall be controlled with an automatic control device to shut off *building* lighting in all spaces.
- (2) Sentence (1) does not apply to,
 - (a) lighting intended for 24-hour operation,
 - (b) emergency lighting, or
 - (c) lighting for spaces where an automatic shut-off would endanger safety or security.
- (3) The automatic control device required in Sentence (1) shall operate on,
 - (a) a scheduled basis using a time-of-day operated control device that turns lighting off at specific programmed times,
 - (b) an occupant sensor that shall turn lighting off within 30 minutes of an occupant leaving a space, or
 - (c) a signal from another control or alarm system that indicates the area is unoccupied.
- (4) Where the automatic control device conforms to Clause (3)(a), an independent program schedule shall be provided for each floor.
- (5) Each space enclosed by *partitions* that extend to the ceiling shall have at least one control device to independently control the general lighting within the space.
- (6) Each manual operated control device shall be readily accessible and located so the occupants can see the controlled lighting.
- (7) Except as required by Sentences (8) and (9) and except for reasons of safety or security, an individual control device shall,
 - (a) be capable of being activated,
 - (i) either manually, or
 - (ii) automatically by sensing an occupant,
 - (b) control a floor area having an area not more than 240 m², and
 - (c) be capable of overriding at any time of-day scheduled shutoff control for not more than 4 h.
- (8) Except in spaces with multi-scene control, a control device that automatically turns lighting off within 30 minutes of all occupants leaving a space shall be provided in,
 - (a) conference rooms,
 - (b) meeting rooms, and
 - (c) employee lunch and break rooms.
- (9) A separate control device shall control,
 - (a) display lighting,
 - (b) accent lighting,
 - (c) case lighting,
 - (d) task lighting,
 - (e) non-visual lighting, and
 - (f) demonstration lighting.

1.1.1.10. Exterior Lighting

- (1) Except as provided in Sentence (2), this Article applies to exterior areas conforming to Sentence 1.1.1.7.(1).
- (2) If the lighting is equipped with a control device independent of the control of other lighting, Sentence (1) does not apply to,
- specialized signal, directional, and marker lighting associated with transportation,
 - advertising signage or directional signage,
 - lighting integral to equipment or instrumentation and installed by its manufacturer,
 - temporary lighting,
 - lighting for industrial production, material handling, transportation sites, and associated storage areas, and
 - lighting used to highlight features of public monuments and *heritage buildings*.
- (3) The exterior lighting power allowance for the exterior areas appurtenant to a *building* shall be determined by multiplying the lighting power density given in Table 1.1.1.10. by the areas or lengths of lighted exterior spaces.

Table 1.1.1.10.
Exterior Lighting Power Densities
Forming Part of Sentence 1.1.1.10.(3)

Exterior Area	Lighting Power Density
Uncovered parking lots and drives	1.0 W/m ²
Walkways less than 3 m wide	2.6 W/linear m
Walkways 3 m or greater, plaza areas, special feature areas	1.7 W/m ²
Stairways	10.8 W/m ²
Building main entries	98 W/linear m of door width
Other doors	66 W/linear m of door width
Canopies (free standing and attached and overhangs)	8.6 W/m ²
Outdoor sales open areas (including vehicle sale lots)	5.4 W/m ²
Street frontage for vehicle sales lots in addition to "open area" allowance	33 W/linear m
Building facades	1.6 W/m ² for each illuminated wall or surface or 12.3 W/linear m for each illuminated wall or surface length
Automated teller machines and night depositories	270 W per location plus 90 W per additional ATM per location
Entrances and gatehouse inspection stations at guarded facilities	8.0 W/m ² of uncovered area
Loading areas for law enforcement and emergency service vehicles	5.4 W/m ² of uncovered area
Drive-up windows	400 W per drive-through
Parking near 24-hour retail entrances	800 W per main entry
Column 1	2

- (4) The total exterior lighting power allowance for the exterior areas appurtenant to a *building* is the sum of the individual power allowances determined from Sentence (3) plus an additional unrestricted allowance of 5% of that sum.
- (5) The installed exterior lighting power shall not exceed the exterior lighting power allowance.
- (6) All exterior building grounds luminaires that operate at greater than 100 watts shall contain lamps having a minimum efficacy of 60 lm/W unless the luminaire is controlled by a motion sensor.

1.1.1.11. Exterior Lighting Controls

- (1) Except as provided in Sentence (2), lighting for exterior applications shall have automatic controls capable of turning off exterior lighting when,
 - (a) sufficient daylight is available, or
 - (b) the lighting is not required during night time hours.
- (2) Sentence (1) does not apply to,
 - (a) lighting for covered vehicle entrances or exits from a *building*,
 - (b) parking structures, and
 - (c) where required for safety, security, or eye adaptation.
- (3) Lighting designated for dusk-to-dawn operation shall be controlled by a time switch or photosensor.
- (4) Lighting not designated for dusk-to-dawn operation shall be controlled by a time switch.

1.1.1.12. Electric Motors

- (1) Electric motor shall conform to the efficiency levels required in Chapter 2 of Division 2.

Division 5

Buildings of Non-Residential Occupancy Within the Scope of Part 9

(Applies to construction for which a permit has been applied for after December 31, 2016)

1.1.	Buildings of Non-Residential Occupancy	
1.1.1.	Buildings of Non-Residential Occupancy.....	95

Division 5

Buildings of Non-Residential Occupancy Within the Scope of Part 9

Section 1.1. Buildings of Non-Residential Occupancy

1.1.1. Buildings of Non-Residential Occupancy

1.1.1.1. Application

- (1) Except as provided in Sentence (2), this Division applies to construction for which a permit has been applied for after December 31, 2016.
- (2) Construction for which a permit is applied for on or before December 31, 2017 is permitted to conform to Division 5 as it read on December 31, 2016. (See Appendix A.)
- (3) Except as provided in Sentences (2) and (3), this Division applies to the energy efficiency of *buildings* or parts of *buildings* where the *building* or part of the *building*
 - (a) is within the scope of Part 9 of Division B of the *Building Code*,
 - (b) does not contain a *residential occupancy*,
 - (c) does not use *electric space heating*, and
 - (d) is intended for occupancy on a continuing basis during the winter months.
- (4) Where the ratio of the gross area of fenestration to the gross area of exterior wall measured from grade to the top of the most upper ceiling exceeds 40%, or the ratio of the gross skylight areas to gross ceiling area exceeds 3%, the *building* envelope shall comply with Article 1.1.2.1. of Chapter 1 of Division 3.
- (5) *Buildings* are exempt from compliance with this Division where they meet the exemptions described in Article 1.2.1.1. of Chapter 1 of Division 3.

1.1.1.2. Building Envelope Requirements

- (1) Except as permitted in Sentence (2), the exterior *building* envelope shall comply with the requirements of Table 1.1.1.2.
- (2) Except for doors, the opaque surfaces shall comply with
 - (a) minimum RSI value of the added insulation in framing cavities and continuous insulation required in Table 1.1.1.2., or
 - (b) maximum overall thermal transmittance U-value for the entire assembly required in Table 1.1.1.2., where U-value is provided.
- (3) Where the top of a *foundation* wall is less than 1 200 mm above the adjoining ground level, those portions of the *foundation* wall that are above ground may be insulated to the level required for the below grade portion of the *foundation* wall.

- (4) The ratio of visible transmittance to solar heat gain coefficient (VT/SHGC) for vertical fenestration assemblies shall be 1.10 or greater.

Table 1.1.1.2.
Building Envelope Requirements Based on Degree-Day Zones⁽¹⁾ (SI)
 Forming Part of Sentences 1.1.1.2.(1) and (2)

Opaque Elements	Zone 1 Less Than 5000 Degree-Days		Zone 2 5000 or More Degree-Days	
	Assembly Max. U-Value ⁽¹⁾	Insulation Min. RSI-Value	Assembly Max. U-Value ⁽¹⁾	Insulation Min. RSI-Value
Roofs				
Without Attic Space - Insulation Above Deck	U-0.164	6.2 ci	U-0.143	7.0 ci
With Attic Space and Other	U-0.107	10.6	U-0.087	12.5
Walls, Above Grade				
All Types	U-0.250	2.3 + 2.6 ci	U-0.250	2.3 + 2.6 ci
Wall, Below Grade				
All Types	C-0.284 ⁽²⁾	3.5 ci	C-0.284 ⁽²⁾	3.5 ci
Exposed Floors				
Mass	U-0.261	3.3 ci	U-0.215	4.1 ci
Lightweight Framing	U-0.164	6.7 ⁽³⁾ + 0.7 ci	U-0.164	6.7 ⁽³⁾ + 0.7 ci
Slab-On-Grade Floors				
Unheated		2.6 for 1200 mm		2.6 for 1200 mm
Heated		1.8 full slab		1.8 full slab
Opaque Doors	U-2.56		U-2.56	
Fenestration	Assembly Max. U-Value ⁽¹⁾	Assembly Max. SHGC	Assembly Max. U-Value ⁽¹⁾	Assembly Max. SHGC
Vertical Fenestration, 0% - 40% of Wall				
All Types Except Entrance Doors	U-2.15	SHGC-0.40	U-1.94	SHGC-0.45
Entrance Doors	U-3.94	SHGC-0.40	U-3.94	SHGC-0.45
Skylight, 0% - 3% of Roof				
All Types	U-2.56	SHGC-0.40	U-2.56	NR
Column 1	2	3	4	5

Notes to Table 1.1.1.2.:

The following definitions apply: ci = continuous insulation

- (1) The overall thermal transmittance value of the entire assembly, includes air films.
 (2) C-Value is overall thermal conductance of the assembly but it does not include soil or air films.
 (3) Where the floor framing depth is 254 mm or less, the insulation between the framing members is permitted to meet a minimum RSI-Value of 5.28.

Table 1.1.1.2.
Building Envelope Requirements Based on Degree-Day Zones⁽¹⁾ (I-P)
 Forming Part of Sentences 1.1.1.2.(1) and (2)

Opaque Elements	Zone 1 Less Than 5000 Degree-Days		Zone 2 5000 or More Degree-Days	
	Assembly Max. U-Value ⁽¹⁾	Insulation Min. R-Value	Assembly Max. U-Value ⁽¹⁾	Insulation Min. R-Value
Roofs				
Without Attic Space - Insulation Above Deck	U-0.029	R-35 ci	U-0.025	R-40 ci
With Attic Space and Other	U-0.019	R-60	U-0.015	R-71
Walls, Above Grade				
All Types	U-0.044	R-13 + R-15 ci	U-0.044	R-13 + R-15 ci
Wall, Below Grade				
All Types	C-0.050 ⁽²⁾	R-20 ci	C-0.050 ⁽²⁾	R-20 ci
Exposed Floors				
Mass	U-0.046	R-18.7 ci	U-0.038	R-23.4 ci
Lightweight Framing	U-0.029	R-38 ⁽³⁾ + R-4 ci	U-0.029	R-38 ⁽³⁾ + R-4 ci
Slab-On-Grade Floors				
Unheated		R-15 for 48 in.		R-15 for 48 in.
Heated		R-10 full slab		R-10 full slab
Opaque Doors	U-0.45		U-0.45	
Fenestration	Assembly Max. U-Value ⁽¹⁾	Assembly Max. SHGC	Assembly Max. U-Value ⁽¹⁾	Assembly Max. SHGC
Vertical Fenestration, 0% - 40% of Wall				
All Types Except Entrance Doors	U-0.38	SHGC-0.40	U-0.34	SHGC-0.45
Entrance Doors	U-0.69	SHGC-0.40	U-0.69	SHGC-0.45
Skylight, 0% - 3% of Roof				
All Types	U-0.45	SHGC-0.40	U-0.45	NR
Column 1	2	3	4	5

Notes to Table 1.1.1.2.:

The following definitions apply: ci = continuous insulation

- (1) The overall thermal transmittance value of the entire assembly, includes air films.
- (2) C-Value is overall thermal conductance of the assembly but it does not include soil or air films.
- (3) Where the floor framing depth is 10 inches or less, the insulation between the framing members is permitted to meet a minimum R-Value of R-30.

1.1.1.3. Air Infiltration

(1) Where a *building* component or assembly separates interior conditioned space from exterior space, interior space from ground or environmentally dissimilar interior spaces, the component or assembly shall contain an *air barrier system* conforming to the applicable requirements of Part 5 or Section 9.25. of Division B of the *Building Code*.

1.1.1.4. Heating, Ventilating and Air-Conditioning

(1) A heating, ventilating and *air-conditioning* system that serves more than one heating, ventilating and *air-conditioning* zone shall conform to Article 1.1.2.1. of Chapter 1 of Division 3 of this Supplementary Standard.

(2) Sentences (3) to (11) and Article 1.1.1.5. apply to a heating, ventilating and *air-conditioning* system that serves a single heating, ventilating and *air-conditioning* zone.

(3) The minimum efficiency of heating, ventilating and *air-conditioning* equipment shall conform to the requirements of Sentence 1.1.2.1.(1) of Chapter 1 of Division 3 of this Supplementary Standard.

(4) An *air-conditioning* system with a cooling capacity of 15.8 kW (54,000 Btu/h) or more shall have an economizer,

(a) controlled by appropriate high limit shut-off control, and

(b) equipped with either barometric or powered relief sized to prevent excess pressurization of the *building*.

(5) Outdoor air dampers for economizer use shall be provided with blade and jamb seals.

(6) Except where the largest exhaust at a single point is less than 75% of the outdoor air, a heat recovery ventilator with a recovery effectiveness of 55% or more at the outside winter design temperature shall be provided where the quantity of the outdoor air supplied to the air duct distribution system

(a) is more than 1400 L/s (3000 cfm), or

(b) operates 8000 hours per year or more.

(7) Where a heat recovery ventilator is installed, the system shall have provisions to bypass or control the heat recovery ventilator to permit operation of the air economizer.

(8) A heating, ventilating and *air-conditioning* system shall be controlled by a manual changeover or dual setpoint thermostat.

(9) Except for a system requiring continuous operation, a heating, ventilating and *air-conditioning* system that has a cooling or heating capacity greater than 4.4 kW (15,000 Btu/h) and a supply fan motor rated for more than 0.5 kW shall be provided with a time clock that,

(a) is capable of starting and stopping the system under different schedules for seven different day-types per week,

(b) is capable of retaining programming and time setting during a loss of power for a period of 10 hours or more,

(c) includes an accessible manual override that allows temporary operation of the system for up to two hours,

(d) is capable of temperature setback down to 13°C (55°F) during off-hours, and

(e) is capable of temperature setup to 32°C (90°F) during off-hours.

(10) Where separate heating and cooling equipment serves the same temperature zone, thermostats shall be interlocked to prevent simultaneous heating and cooling.

(11) A heating, ventilating and *air-conditioning* system with a design supply air capacity greater than 5000 L/s (10,600 cfm) shall have optimum start controls.

1.1.1.5. Ducts, Plenums and Piping

- (1) A duct or a plenum that is not protected by an insulated exterior wall or that is exposed to an unheated space shall be
 - (a) sealed in accordance with SMACNA, “HVAC Duct Construction Standards - Metal and Flexible”, to minimize air leakage, and
 - (b) insulated to provide a thermal resistance of not less than RSI 1.4 (R8).
- (2) A supply or *exhaust duct* or *plenum* that is located in a *conditioned space* shall be sealed in accordance with SMACNA, “HVAC Duct Construction Standards - Metal and Flexible”, to minimize air leakage.
- (3) Except for piping within prefabricated equipment, piping used for steam, hot water heating or cooling shall be insulated in accordance with Table 1.1.1.5.
- (4) Insulation exposed to weather shall be protected by a covering such as aluminum, sheet metal, painted canvas or plastic.
- (5) An *exhaust duct* with a design capacity of more than 140 L/s (300 cfm) on a heating, ventilating and *air-conditioning* system that does not operate continuously shall be equipped with a gravity or motorized damper that will automatically shut when the system is not in operation.
- (6) An air duct distribution system shall be balanced in the following sequence:
 1. Minimize throttling losses.
 2. If the fan is rated for more than 0.75 kW, adjust the fan speed to meet design flow conditions.
- (7) A hydronic system shall be proportionately balanced to minimize throttling losses.

Table 1.1.1.5.
Minimum Thickness of Pipe Insulation⁽¹⁾
 Forming Part of Sentences 1.1.1.5.(3) and 1.1.1.6.(2)

Use of Pipe		Nominal Pipe Size Not More than 40 mm	Nominal Pipe Size More than 40 mm
		Minimum Pipe Insulation Thickness, mm	Minimum Pipe Insulation Thickness, mm
Steam		64	76
Hot water heating		38	51
Domestic hot water	40°C to 60°C	25	38
	61°C and higher	38	51
Cooling		13	25
Column 1		2	3

Notes to Table 1.1.1.5.:

- (1) Insulation material shall have a thermal conductivity of not more than 0.042 W/(m·°C).

1.1.1.6. Service Water Heating

- (1) The minimum efficiency of water heating equipment used solely for heating *potable* water and hot water storage tanks shall conform to the requirements of Sentence 1.1.2.1.(1) of Chapter 1 of Division 3 of this Supplementary Standard.
- (2) Domestic hot water heating piping shall be insulated in accordance with Table 1.1.1.5. if it is,
 - (a) recirculating system piping,
 - (b) located within the first 2.5 m (8 ft) of outlet piping in a constant temperature non-recirculating storage system,
 - (c) an inlet pipe located between the storage tank and a heat trap in a non-recirculating storage system, or
 - (d) a pipe that is externally heated by methods such as a heat trace or impedance heating.
- (3) A hot water storage tank shall be provided with a temperature control to permit adjustment of the water storage temperature.
- (4) An automatic time switch or other control that can be set to switch off the usage temperature maintenance system during extended periods when hot water is not required shall be installed in a domestic hot water system that is designed to maintain usage temperatures in hot water pipes such as recirculating hot water systems or heat trace.
- (5) If a recirculating pump is used to maintain storage tank water temperature, the pump shall be equipped with a control to limit its operation to a period from the start of the heating cycle to a maximum of five minutes after the end of the heating cycle.
- (6) In a washroom located in a public facility, a device shall be provided to control the maximum temperature of water delivered from a lavatory faucets to not more than 43°C (110°F).
- (7) A vertical pipe riser that serves a storage water heater or a storage tank shall have heat traps on both the inlet and outlet piping as close as practical to the tank if,
 - (a) the riser is in a non-recirculating system, and
 - (b) the storage water heater or the storage tank does not have integral heat traps.
- (8) A system that provides both space heating and domestic water heating shall conform to the minimum efficiency values required by Clause 1.1.2.1.(1)(c) of Chapter 1 of Division 3 of this Supplementary Standard.

1.1.1.7. Lighting

- (1) Except as provided in Sentence (2), Articles 1.1.1.8. to 1.1.1.11. apply to,
 - (a) interior spaces of a *building*,
 - (b) exterior *building* features, including facades, illuminated roofs, architectural features, entrances, *exits*, loading docks and illuminated canopies, and
 - (c) exterior *building* ground lighting provided through the *building's* electrical service.
- (2) Articles 1.1.1.8. to 1.1.1.11. do not apply to emergency lighting that is automatically turned off during the normal use of the *building*.
- (3) Except as provided in Sentence (4), luminaires designed for use with one or three linear fluorescent lamps greater than 30 W each shall use two-lamp tandem-wired ballasts in place of single-lamp ballasts when two or more luminaires are in the same space and on the same control device.
- (4) The tandem wiring required by Sentence (3) is not required for,
 - (a) recessed luminaires located more than 3 m apart, measured centre to centre,
 - (b) surface mounted or pendant luminaires that are not continuous,
 - (c) luminaires that use single-lamp high-frequency electronic ballasts,
 - (d) luminaires that use three-lamp high-frequency electronic or three-lamp electromagnetic ballasts, and
 - (e) luminaires on emergency circuits.

1.1.1.8. Interior Lighting

- (1) The interior lighting power allowance for a *building* is the sum of the lighting power allowances, in watts, of all *building* area types and shall include all permanently installed general, task and furniture lighting systems and luminaires.
- (2) The interior lighting power allowance shall be determined by multiplying the lighting power density given in Table 1.1.1.8. by the gross lighted areas of the *building* area type.
- (3) The installed interior lighting power shall not exceed the interior lighting power allowance.
- (4) Except as provided in Sentence (5), the installed interior lighting power shall include all power used by luminaires, including lamps, ballasts, current regulators and control devices.
- (5) The following lighting equipment and applications shall not be considered when determining the installed interior lighting power or the interior lighting power allowance:
 - (a) lighting that is integral to equipment or instrumentation and is installed by its manufacturer,
 - (b) lighting specifically designed for use only during medical or dental procedures and lighting integral to medical equipment,
 - (c) lighting that is integral to both open and glass-enclosed refrigerator and freezer cases,
 - (d) lighting that is integral to food warming and food preparation equipment,
 - (e) lighting for plant growth or maintenance,
 - (f) lighting in spaces specifically designed for use by persons with low or no vision,
 - (g) lighting in retail display windows if the display area is enclosed by ceiling-height partitions,
 - (h) lighting in interior spaces that have been specifically designated as a *heritage building*,
 - (i) lighting that is an integral part of advertising or directional signage,
 - (j) *exit* signs,
 - (k) lighting that is displayed for sale, and
 - (l) educational lighting demonstration systems.
- (6) Trade-offs among *building* area types are permitted provided that the total installed interior lighting power does not exceed the interior lighting power allowance.

Table 1.1.1.8.
Interior Lighting Power Densities
Forming Part of Sentence 1.1.1.8.(2)

Building Area Type	Lighting Power Density,	
	W/m ²	(W/ft ²)
Automotive Facility	7.6	(0.71)
Fast Food	8.5	(0.79)
Fire Station	5.7	(0.53)
Health Care Offices - Clinic	8.8	(0.82)
Manufacturing Facility	9.7	(0.90)
Office	8.5	(0.79)
Police Station (without detention quarters)	8.6	(0.80)
Post Office	7.2	(0.67)
Retail	11.4	(1.06)
Storage Garage	1.6	(0.15)
Warehouse	5.2	(0.48)
Workshop	9.7	(0.90)
Column 1	2	

1.1.1.9. Interior Lighting Controls

- (1) Except as provided in Sentence (2), there shall be one or more manual lighting controls in each space that controls all of the lighting in the space.
- (2) Sentence (1) does not apply to,
 - (a) lighting intended for 24-hour operation,
 - (b) emergency lighting, or
 - (c) lighting for spaces where an automatic shut-off would endanger safety or security.
- (3) Each control device required in Sentence (1) shall be readily accessible and located so that the occupants can see the controlled lighting when operating the control device.
- (4) For the purpose of Sentence (1), remote location of the control device shall be permitted for reasons of safety or security when the control device is clearly labelled to identify the controlled lighting.
- (5) Each space excluding corridors, storage rooms, restrooms, and parking garages shall have a manual control device that allows the occupant to reduce lighting power by a minimum of 50% and to turn the lighting off.
- (6) A total lighting load not exceeding 0.2 W/m^2 multiplied by the gross lighted area of the *building* shall be permitted to operate at all times.
- (7) Except as provided by Sentences (2) and (6), all lighting shall be automatically controlled to turn off when the *building* is either unoccupied or scheduled to be unoccupied.
- (8) The automatic control device required in Sentence (7) shall operate on,
 - (a) a scheduled basis using a time-of-day operated control device that turns lighting off at specific programmed times, or
 - (b) a signal from another control or alarm system that indicates the area is unoccupied.
- (9) Where the automatic control device conforms to Clause (8), an independent program schedule shall be provided for each floor, and the program shall account for weekends and holiday.
- (10) Automatic daylight sensing controls shall be used to control general lighting where the total lighting input power is 150 W or greater and where skylights or roof monitors are installed, in the following spaces:
 - (a) dining areas in fast food *buildings*,
 - (b) apparatus rooms in fire station buildings,
 - (c) retail spaces, and
 - (d) office spaces
- (11) Except in retail spaces, automatic daylight sensing controls shall be used to control general lighting in a space where the total lighting input power is 150 W or greater and the total area of exterior vertical fenestration in the space is 11 m^2 or greater.
- (12) The automatic daylight sensing controls required in Sentences (10) and (11) shall reduce lighting in response to available daylight using continuous dimming or with at least two intermediate control points between fully on and fully off.
- (13) Lighting in corridors, post office sorting areas, warehouse storage areas, and parking garages shall be controlled by occupancy sensors that reduce the lighting power by a minimum of 50% when no activity is detected for not longer than 20 minutes.
- (14) The control device required in Sentence (13) shall not control an area more than 330 m^2 .

(15) Lighting in the following spaces shall be controlled by occupancy sensors that automatically turn off the lighting when no activity is detected for not longer than 20 minutes:

- (a) enclosed office areas less than 23 m² (250 ft²),
- (b) classrooms,
- (c) training rooms,
- (d) conference rooms,
- (e) meeting rooms,
- (f) breakrooms,
- (g) non-warehouse storage areas,
- (h) dressing / fitting rooms, and
- (i) restrooms

(16) Control devices separate from those used for general lighting shall control the following:

- (a) display lighting,
- (b) accent lighting,
- (c) case lighting,
- (d) task lighting,
- (e) non-visual lighting, and
- (f) demonstration lighting.

1.1.1.10. Exterior Lighting

- (1) Except as provided in Sentence (2), this Article applies to exterior areas conforming to Sentence 1.1.1.7.(1).
- (2) If the lighting is equipped with a control device independent of the control of other lighting, Sentence (1) does not apply to,
 - (a) specialized signal, directional, and marker lighting associated with transportation,
 - (b) advertising signage or directional signage,
 - (c) lighting integral to equipment or instrumentation and installed by its manufacturer,
 - (d) temporary lighting,
 - (e) lighting for industrial production, material handling, transportation sites, and associated storage areas, and
 - (f) lighting used to highlight features of public monuments and *heritage buildings*.
- (3) The exterior lighting power allowance for the exterior areas appurtenant to a *building* shall be determined by multiplying the lighting power density given in Table 1.1.1.10. by the areas or lengths of lighted exterior spaces.
- (4) The total exterior lighting power allowance for the exterior areas appurtenant to a *building* is the sum of the individual power allowances including the base allowance determined from Sentence (3).
- (5) The installed exterior lighting power excluding façade lighting shall not exceed the exterior lighting power allowance calculated in Sentence (4).
- (6) The installed exterior lighting power of façade lighting shall not exceed 1.1 W/m² multiplied by the façade area.
- (7) All exterior *building* grounds luminaires that operate at greater than 100 watts shall contain lamps having a minimum efficacy of 60 lm/W unless the luminaire is controlled by a motion sensor.

Table 1.1.1.10.
Exterior Lighting Power Densities
Forming Part of Sentence 1.1.1.10.(3)

Exterior Area	Maximum Exterior Lighting Power Allowance
Base Allowance	400 W
Special Feature Areas, Walkways, Plazas	1.1 W/m ² (0.10 W/ft ²)
Landscape	0.43 W/m ² (0.04 W/ft ²)
Pedestrian and Vehicular Entrances and Exits	46 W/linear m of door width (14 W/linear ft of door width)
Stairs and Ramps	7.5 W/m ² (0.70 W/ft ²)
Parking Lots and Drives	0.43 W/m ² (0.04 W/ft ²)
All Other Areas not Listed	2.2 W/m ² (0.20 W/ft ²)
Column 1	2

1.1.1.11. Exterior Lighting Controls

- (1) Except as provided in Sentence (2), control devices shall be installed that:
 - (a) automatically turn off the exterior lighting when sufficient daylight is available,
 - (b) automatically turn off *building* façade and landscape lighting during non-business hours, and
 - (c) automatically reduce the connected lighting power for exterior lighting excluding *building* façade and landscape lighting, by at least 30% during non-business hours or alternatively, during any period when no activity is detected for not longer than 15 minutes.
- (2) Sentence (1) does not apply to,
 - (a) lighting for covered vehicle entrances or *exits* from a *building*, or
 - (b) parking structures where required for safety, security, or eye adaptation.

1.1.1.12. Electric Motors

- (1) Electric motors shall conform to the efficiency levels required in Chapter 2 of Division 3.

Appendix A

Division 2

Chapter 1

A-1.1.2.1.(1)(a) Revocation of 1997 MNECB.

Designers are permitted to continue to use the 1997 MNECB option with the 25% improvement approach in addition to a further 13% enhancement for a limited time. The deadline for permit application using the enhanced 1997 MNECB approach is December 31, 2017.

A-1.1.2.1.(1) Energy Efficiency Design.

The performance levels required in Clauses (a) and (b) are set based on the given percentage of reduction in annual energy use (kWh, GJ, etc) from the level that would occur if the building was merely designed in accordance with the referenced standard. Clauses (c) and (d) contain prescriptive, trade-off and performance methods. In the case of performance method, the performance level is set in accordance with Section 11 of 2010 ANSI/ASHRAE/IES 90.1 and Chapter 2, or Part 8 of the 2011 NECB and Chapter 3 respectively.

A-1.1.3.1.(2) Alternatives to Compliance With 2010 ANSI/ASHRAE/IES 90.1 in Chapter 2.

Where the energy efficiency of a building is designed in conformance with Clause 1.1.2.1.(1)(b), the designer is permitted to comply with any provision in Chapter 2 in lieu of the corresponding requirement in ANSI/ASHRAE/IES 90.1. For example, equipment tested to Canadian testing procedures listed in the 2011 NECB are permitted to be used in conjunction with Clause 1.1.2.1.(1)(b).

Chapter 2

A-Tables SB 5.5-5 to SB 5.5-7 Building Envelope.

Building envelope Tables SB 5.5-5 to SB 5.5-7 in this Chapter are based on building envelope Tables A-5 to A-7 in ANSI/ASHRAE/USGBC/IES Standard 189.1-2009 which supersede building envelope Tables 5.5-5 to 5.5-7 in 2010 ANSI/ASHRAE/IES 90.1.

Envelope assemblies are required to meet either the maximum U-factor or the contain insulation that meets the minimum R-Values specified in the Tables. Where R-Values or combination of R-Values are specified, alternative R-Value combinations are permitted to address variations in R-Value of insulation products.

A-1.1.1.4.(3) Orientation of Walls.

South (or East or West) oriented wall area includes wall area that is oriented less than or equal to 45 degree of true South (or East or West).

Division 3

Chapter 1

A-1.1.1.1.(2) Continuation of Division 3 of MMAH Supplementary Standard SB-10, September 14, 2012 until December 31, 2017.

Division 3 of MMAH Supplementary Standard SB-10, September 14, 2012 contained requirements that would have come into effect on January 1, 2017. These requirements have been updated in this edition; however, Division 3 of MMAH Supplementary Standard SB-10, September 14, 2012, as it read on December 31, 2016 can continue to be used for construction for which a permit is applied for on or before December 31, 2017.

Chapter 2

A-1.1.1.8.(2) and A-1.1.1.10.(2) Metering and Energy Use Monitoring Devices.

The mandating of meters and/or monitoring devices in buildings is governed by the Green Energy Act. For the purposes of complying with the Building Code, buildings are required to be designed in a manner that facilitates the future installation of these devices, to measure energy consumption of building systems and the building as described in this Supplementary Standard. Metering and monitoring devices must be installed in buildings where required by the Green Energy Act.

Chapter 3

A-1.1.1.10. and A-1.1.1.11. Metering and Energy Use Monitoring Devices.

The mandating of meters and/or monitoring devices in buildings is governed by the Green Energy Act. For the purposes of complying with the Building Code, buildings are required to be designed in a manner that facilitates the future installation of these devices, to measure energy consumption of building systems and the building as described in this Supplementary Standard. Metering and monitoring devices must be installed in buildings where required by the Green Energy Act.

Division 5

A-1.1.1.1.(2) Continuation of Division 5 of MMAH Supplementary Standard SB-10, September 14, 2012 until December 31, 2017.

Division 5 of MMAH Supplementary Standard SB-10, September 14, 2012 contained requirements that would have come into effect on January 1, 2017. These requirements have been updated in this edition; however, Division 5 of MMAH Supplementary Standard SB-10, September 14, 2012, as it read on December 31, 2016 can continue to be used for construction for which a permit is applied for on or before December 31, 2017.

MMAH Supplementary Standard SB-11

Construction of Farm Buildings

September 14, 2012

COMMENCEMENT

MMAH Supplementary Standard SB-11 comes into force on the 1st day of January, 2014.

© Copyright

© Copyright Queen's Printer for Ontario 2012

All rights reserved.

Questions regarding copyright, including reproduction and distribution, may be directed to the Director,
Building and Development Branch of the Ministry of Municipal Affairs and Housing.

SB-11 Construction of Farm Buildings

Section 1 General

1.1. Scope

1.1.1. Application

(1) This Section applies to farm buildings of low human occupancy.

1.1.2. Construction Requirements

(1) The construction of farm buildings of low human occupancy shall, subject to Article 1.3.1.2. of Division A of the Building Code, conform to the requirements of Part 9 of Division B of the Building Code except as provided in this Section.

1.2. Lumber

1.2.1. Lumber Requirements

(1) Except as permitted by Article 1.2.2., lumber shall conform to appropriate requirements in Subsection 9.3.2. of Division B of the Building Code.

1.2.2. Ungraded Lumber

(1) Ungraded lumber may be used for wood posts, joists, rafters, lintels, beams and wall studs in a farm building of low human occupancy of not more than one storey in building height.

(2) Ungraded lumber means lumber that has not been grade-stamped to indicate its grade, as determined by the NLGA “Standard Grading Rules for Canadian Lumber (Interpretation Included)”, but that meets the following visual attributes:

- (a) it is rough sawn to full nominal size,
- (b) it has no evidence of decay,
- (c) it has no tight knots that exceed 25 percent of the cross section and that are spaced closer than 150 mm on centres,
- (d) it has no loose knots or holes that exceed 25 percent of the cross section and that are spaced closer than 600 mm on centres,
- (e) it has the slope of grain not exceeding 1 (vertical) in 4 (horizontal), and
- (f) it is free of excessive warp.

1.3. Structural Requirements

1.3.1. Structural Design

(1) Except as provided in Articles 1.3.2. to 1.3.4., wood posts, joists, rafters, lintels, beams and wall studs shall be designed in conformance with Section 9.4. of Division B of the Building Code.

1.3.2. Posts

(1) In a farm building of low human occupancy, the size of wood posts shall conform to Tables 1.3.2.A. to 1.3.2.J. for the loads shown in the Tables.

1.3.3. Spans

(1) In a farm building of low human occupancy, the spans of wood joists, rafters, lintels and beams shall conform to the spans shown in Tables 1.3.3.K. to 1.3.3.T. for the loads shown in the Tables.

1.3.4. Stud Size and Spacing

(1) In a farm building of low human occupancy, the size and spacing of wood studs shall conform to Tables 1.3.4.U. to 1.3.4.W. for the loads shown in the Tables.

Table 1.3.2.A.
Post Sizes for Diaphragm-Braced Farm Buildings of Low Human Occupancy
 Forming Part of Sentence 1.3.2.(1)

Building Width, m	Wall Height, m	Spruce-Pine-Fir, No. 1, Dressed (Post and Timber Grades)														
		For Wind Loading $q_{10} \leq 0.30$ kPa														
		Post Spacing, 2.4 m					Post Spacing, 3.6 m					Post Spacing, 4.8 m				
		Roof Load, kPa					Roof Load, kPa					Roof Load, kPa				
		1.4	1.9	2.4	2.8	3.3	1.4	1.9	2.4	2.8	3.3	1.4	1.9	2.4	2.8	3.3
9.14	≤3.0	A	A	A	A	A	A	A	A	A	A	A	A	B	B	B
	3.6	A	A	A	A	A	A	A	B	B	B	B	B	B	C	C
	4.2	B	B	B	B	B	B	B	B	C	C	B	C	C	C	C
	4.8	B	B	B	B	B	B	C	C	C	C	C	C	C	C	C
	6.0	C	C	C	C	C	C	C	C	D	D	C	D	D	—	—
12.1	≤3.0	A	A	A	A	A	A	A	A	B	B	A	B	B	B	C
	3.6	A	A	A	A	B	A	B	B	B	C	B	B	C	C	C
	4.2	B	B	B	B	B	B	B	C	C	C	C	C	C	C	C
	4.8	B	B	B	C	C	C	C	C	C	C	C	C	D	D	D
	6.0	C	C	C	C	C	C	C	D	D	—	D	D	—	—	—
15.2	≤3.0	A	A	A	A	A	A	A	B	B	B	B	B	B	C	C
	3.6	A	A	A	B	B	B	B	B	C	C	B	C	C	C	C
	4.2	B	B	B	B	C	B	C	C	C	C	C	C	C	D	D
	4.8	B	B	C	C	C	C	C	C	C	D	C	C	D	D	—
	6.0	C	C	C	C	D	C	D	D	—	—	D	—	—	—	—
18.2	≤3.0	A	A	A	B	B	A	B	B	B	C	B	B	C	C	C
	3.6	A	A	B	B	B	B	B	C	C	C	C	C	C	C	D
	4.2	B	B	B	C	C	C	C	C	C	C	C	C	D	D	D
	4.8	B	C	C	C	C	C	C	C	D	D	C	D	D	—	—
	6.0	C	C	C	D	D	D	D	—	—	—	—	—	—	—	—
Column 1	2	3	4	5	6	7	8	9	10	11	12	13	14	15	16	17

Legend - Post Sizes:

A = 89 mm x 140 mm

B = 140 mm x 140 mm

C = 140 mm x 184 mm

D = 184 mm x 184 mm

Notes to Table 1.3.2.A.:

- (1) Designs are based on load combinations of total roof load and wind load acting at the same time on a closed building.
- (2) Posts shall be oriented with the long dimension parallel to the building width.
- (3) Bracing systems shall be specified by a competent designer.
- (4) Posts shall be situated on footings and shall be anchored to prevent wind uplift.
- (5) Posts shall be constrained against lateral movement at ground level and at the footing. Concrete floor, splash-rail and uplift anchor help to meet this condition.
- (6) Post designs are based on partial fixity condition due to embedment in soil.
- (7) Footing excavations should be backfilled with parent material unless otherwise specified by a competent designer.

Table 1.3.2.B.
Post Sizes for Diaphragm-Braced Farm Buildings of Low Human Occupancy
 Forming Part of Sentence 1.3.2.(1)

Building Width, m	Wall Height, m	Spruce-Pine-Fir, No. 1, Dressed (Post and Timber Grades)														
		For Wind Loading $q_{10} \leq 0.45$ kPa														
		Post Spacing, 2.4 m					Post Spacing, 3.6 m					Post Spacing, 4.8 m				
		Roof Load, kPa					Roof Load, kPa					Roof Load, kPa				
		1.4	1.9	2.4	2.8	3.3	1.4	1.9	2.4	2.8	3.3	1.4	1.9	2.4	2.8	3.3
9.14	≤3.0	A	A	A	A	A	A	A	A	A	B	A	B	B	B	B
	3.6	A	A	A	A	A	A	B	B	B	B	B	B	C	C	C
	4.2	B	B	B	B	B	B	B	C	C	C	C	C	C	C	C
	4.8	B	B	B	C	C	C	C	C	C	C	C	C	C	D	D
	6.0	C	C	C	C	C	C	D	D	D	D	D	—	—	—	—
12.1	≤3.0	A	A	A	A	A	A	A	B	B	B	B	B	B	C	C
	3.6	A	A	A	B	B	B	B	B	C	C	C	C	C	C	C
	4.2	B	B	B	B	C	C	C	C	C	C	C	C	C	C	D
	4.8	B	C	C	C	C	C	C	C	C	C	C	C	D	D	D
	6.0	C	C	C	C	D	D	D	D	—	—	—	—	—	—	—
15.2	≤3.0	A	A	A	A	B	A	B	B	B	C	B	B	C	C	C
	3.6	A	A	B	B	B	B	B	C	C	C	C	C	C	C	D
	4.2	B	B	B	C	C	C	C	C	C	C	C	C	D	D	D
	4.8	B	C	C	C	C	C	C	C	D	D	C	D	D	—	—
	6.0	C	C	C	D	D	D	D	—	—	—	—	—	—	—	—
18.2	≤3.0	A	A	A	B	B	B	B	B	C	C	B	C	C	C	C
	3.6	A	B	B	B	C	B	C	C	C	C	C	C	C	D	D
	4.2	B	B	C	C	C	C	C	C	C	D	C	D	D	D	—
	4.8	C	C	C	C	C	C	C	D	D	—	D	D	—	—	—
	6.0	C	C	D	D	—	D	—	—	—	—	—	—	—	—	—
Column 1	2	3	4	5	6	7	8	9	10	11	12	13	14	15	16	17

Legend - Post Sizes:

A = 89 mm x 140 mm

B = 140 mm x 140 mm

C = 140 mm x 184 mm

D = 184 mm x 184 mm

Notes to Table 1.3.2.B.:

- (1) Designs are based on load combinations of total roof load and wind load acting at the same time on a closed building.
- (2) Posts shall be oriented with the long dimension parallel to the building width.
- (3) Bracing systems shall be specified by a competent designer.
- (4) Posts shall be situated on footings and shall be anchored to prevent wind uplift.
- (5) Posts shall be constrained against lateral movement at ground level and at the footing. Concrete floor, splash-rail and uplift anchor help to meet this condition.
- (6) Post designs are based on partial fixity condition due to embedment in soil.
- (7) Footing excavations should be backfilled with parent material unless otherwise specified by a competent designer.

Table 1.3.2.C.
Post Sizes for Knee-Braced Farm Buildings of Low Human Occupancy
 Forming Part of Sentence 1.3.2.(1)

Building Width, m	Wall Height, m	Spruce-Pine-Fir, No. 1, Dressed (Post and Timber Grades)														
		For Wind Loading $q_{10} \leq 0.30$ kPa														
		Post Spacing, 2.4 m					Post Spacing, 3.6 m					Post Spacing, 4.8 m				
		Roof Load, kPa					Roof Load, kPa					Roof Load, kPa				
		1.4	1.9	2.4	2.8	3.3	1.4	1.9	2.4	2.8	3.3	1.4	1.9	2.4	2.8	3.3
9.14	≤3.0	A	A	A	A	A	A	A	A	B	B	A	B	B	B	C
	3.6	A	A	A	A	B	A	B	B	B	C	B	C	C	C	C
	4.2	B	B	B	B	B	B	C	C	C	C	C	C	C	C	C
	4.8	C	C	C	C	C	C	C	C	C	C	C	C	C	D	D
	6.0	C	C	C	C	C	C	D	D	D	—	D	—	—	—	—
12.1	≤3.0	A	A	A	A	A	A	A	B	B	B	B	B	C	C	C
	3.6	A	A	B	B	B	B	B	C	C	C	C	C	C	C	C
	4.2	B	B	B	C	C	C	C	C	C	C	C	C	C	D	D
	4.8	C	C	C	C	C	C	C	C	D	D	C	D	D	—	—
	6.0	C	C	C	D	D	D	D	—	—	—	—	—	—	—	—
15.2	≤3.0	A	A	A	B	B	A	B	B	C	C	B	C	C	C	C
	3.6	A	B	B	B	C	B	C	C	C	C	C	C	C	C	D
	4.2	B	B	C	C	C	C	C	C	C	D	C	C	D	D	—
	4.8	C	C	C	C	C	C	C	D	D	—	D	D	—	—	—
	6.0	C	C	D	D	—	D	—	—	—	—	—	—	—	—	—
18.2	≤3.0	A	A	B	B	B	B	B	C	C	C	B	C	C	C	D
	3.6	B	B	B	C	C	C	C	C	C	C	C	C	C	D	D
	4.2	B	C	C	C	C	C	C	C	D	D	C	D	D	—	—
	4.8	C	C	C	C	D	C	D	D	—	—	D	—	—	—	—
	6.0	C	D	D	—	—	—	—	—	—	—	—	—	—	—	—
Column 1	2	3	4	5	6	7	8	9	10	11	12	13	14	15	16	17

Legend - Post Sizes:

A = 89 mm x 140 mm

B = 140 mm x 140 mm

C = 140 mm x 184 mm

D = 184 mm x 184 mm

Notes to Table 1.3.2.C.:

- (1) Designs are based on load combinations of total roof load and wind load acting at the same time on a closed building.
- (2) Posts shall be oriented with the long dimension parallel to the building width.
- (3) Bracing systems shall be specified by a competent designer.
- (4) Posts shall be situated on footings and shall be anchored to prevent wind uplift.
- (5) Posts shall be constrained against lateral movement at ground level and at the footing. Concrete floor, splash-rail and uplift anchor help to meet this condition.
- (6) Post designs are based on partial fixity condition due to embedment in soil.
- (7) Footing excavations should be backfilled with parent material unless otherwise specified by a competent designer.

Table 1.3.2.D.
Post Sizes for Knee-Braced Farm Buildings of Low Human Occupancy
 Forming Part of Sentence 1.3.2.(1)

Building Width, m	Wall Height, m	Spruce-Pine-Fir, No. 1, Dressed (Post and Timber Grades)														
		For Wind Loading $q_{10} \leq 0.45$ kPa														
		Post Spacing, 2.4 m					Post Spacing, 3.6 m					Post Spacing, 4.8 m				
		Roof Load, kPa					Roof Load, kPa					Roof Load, kPa				
		1.4	1.9	2.4	2.8	3.3	1.4	1.9	2.4	2.8	3.3	1.4	1.9	2.4	2.8	3.3
9.14	≤3.0	A	A	A	A	A	A	A	B	B	B	B	B	B	C	C
	3.6	A	A	A	B	B	B	B	B	C	C	C	C	C	C	C
	4.2	B	B	B	B	C	C	C	C	C	C	C	C	C	C	D
	4.8	C	C	C	C	C	C	C	C	C	D	C	D	D	D	—
	6.0	C	C	C	C	D	D	D	—	—	—	—	—	—	—	—
12.1	≤3.0	A	A	A	A	B	A	B	B	B	C	B	B	C	C	C
	3.6	B	B	B	B	B	B	C	C	C	C	C	C	C	C	C
	4.2	B	B	C	C	C	C	C	C	C	C	C	C	D	D	D
	4.8	C	C	C	C	C	C	C	D	D	D	D	D	—	—	—
	6.0	C	C	D	D	D	D	—	—	—	—	—	—	—	—	—
15.2	≤3.0	A	A	B	B	B	B	B	B	C	C	B	C	C	C	C
	3.6	A	B	B	C	C	C	C	C	C	C	C	C	C	D	D
	4.2	B	C	C	C	C	C	C	C	D	D	C	D	D	—	—
	4.8	C	C	C	C	C	C	D	D	D	—	D	—	—	—	—
	6.0	C	D	D	—	—	—	—	—	—	—	—	—	—	—	—
18.2	≤3.0	A	A	B	B	B	B	B	C	C	C	C	C	C	C	D
	3.6	B	B	C	C	C	C	C	C	C	D	C	C	D	D	—
	4.2	C	C	C	C	C	C	C	D	D	D	D	D	—	—	—
	4.8	C	C	C	D	D	C	D	—	—	—	D	—	—	—	—
	6.0	D	D	—	—	—	—	—	—	—	—	—	—	—	—	—
Column 1	2	3	4	5	6	7	8	9	10	11	12	13	14	15	16	17

Legend - Post Sizes:

A = 89 mm x 140 mm

B = 140 mm x 140 mm

C = 140 mm x 184 mm

D = 184 mm x 184 mm

Notes to Table 1.3.2.D.:

- (1) Designs are based on load combinations of total roof load and wind load acting at the same time on a closed building.
- (2) Posts shall be oriented with the long dimension parallel to the building width.
- (3) Bracing systems shall be specified by a competent designer.
- (4) Posts shall be situated on footings and shall be anchored to prevent wind uplift.
- (5) Posts shall be constrained against lateral movement at ground level and at the footing. Concrete floor, splash-rail and uplift anchor help to meet this condition.
- (6) Post designs are based on partial fixity condition due to embedment in soil.
- (7) Footing excavations should be backfilled with parent material unless otherwise specified by a competent designer.

Table 1.3.2.E.
Post Sizes for Diaphragm-Braced Farm Buildings of Low Human Occupancy
Forming Part of Sentence 1.3.2.(1)

Building Width, m	Wall Height, m	Ungraded Lumber, Full-Dimensioned														
		For Wind Loading $q_{10} \leq 0.30$ kPa														
		Post Spacing, 2.4 m					Post Spacing, 3.6 m					Post Spacing, 4.8 m				
		Roof Load, kPa					Roof Load, kPa					Roof Load, kPa				
		1.4	1.9	2.4	2.8	3.3	1.4	1.9	2.4	2.8	3.3	1.4	1.9	2.4	2.8	3.3
9.14	≤3.0	A	A	A	A	A	A	A	A	B	B	A	B	B	C	C
	3.6	A	A	A	A	B	A	B	B	B	C	B	C	C	C	C
	4.2	B	B	B	B	B	B	B	C	C	C	C	C	C	C	D
	4.8	B	B	B	B	C	C	C	C	C	C	C	C	C	D	D
	6.0	C	C	C	C	C	C	C	D	D	D	D	D	—	—	—
12.1	≤3.0	A	A	A	A	B	A	B	B	B	C	B	B	C	C	C
	3.6	A	A	B	B	B	B	B	C	C	C	C	C	C	C	D
	4.2	B	B	B	B	C	B	C	C	C	C	C	C	D	D	D
	4.8	B	B	C	C	C	C	C	C	C	D	C	D	D	D	—
	6.0	C	C	C	C	D	C	D	D	—	—	D	—	—	—	—
15.2	≤3.0	A	A	A	B	B	B	B	C	C	C	B	C	C	D	D
	3.6	A	B	B	B	C	B	C	C	C	C	C	C	D	D	D
	4.2	B	B	C	C	C	C	C	C	D	D	C	D	D	—	—
	4.8	B	C	C	C	C	C	C	D	D	D	D	D	—	—	—
	6.0	C	C	C	D	D	D	D	—	—	—	—	—	—	—	—
18.2	≤3.0	A	A	B	B	C	B	B	C	C	D	C	C	D	D	—
	3.6	A	B	B	C	C	C	C	C	D	D	C	D	D	—	—
	4.2	B	C	C	C	C	C	C	D	D	D	C	D	—	—	—
	4.8	C	C	C	C	D	C	D	D	—	—	D	—	—	—	—
	6.0	C	C	D	D	—	D	—	—	—	—	—	—	—	—	—
Column 1	2	3	4	5	6	7	8	9	10	11	12	13	14	15	16	17

Legend - Post Sizes:

A = 101.6 mm x 152.4 mm

B = 152.4 mm x 152.4 mm

C = 152.4 mm x 203.2 mm

D = 203.2 mm x 203.2 mm

Notes to Table 1.3.2.E:

- (1) Designs are based on load combinations of total roof load and wind load acting at the same time on a closed building.
- (2) Posts shall be oriented with the long dimension parallel to the building width.
- (3) Bracing systems shall be specified by a competent designer.
- (4) Posts shall be situated on footings and shall be anchored to prevent wind uplift.
- (5) Posts shall be constrained against lateral movement at ground level and at the footing. Concrete floor, splash-rail and uplift anchor help to meet this condition.
- (6) Post designs are based on partial fixity condition due to embedment in soil.
- (7) Footing excavations should be backfilled with parent material unless otherwise specified by a competent designer.

Table 1.3.2.F.
Post Sizes for Diaphragm-Braced Farm Buildings of Low Human Occupancy
Forming Part of Sentence 1.3.2.(1)

Building Width, m	Wall Height, m	Ungraded Lumber, Full-Dimensioned														
		For Wind Loading $q_{10} \leq 0.45$ kPa														
		Post Spacing, 2.4 m					Post Spacing, 3.6 m					Post Spacing, 4.8 m				
		Roof Load, kPa					Roof Load, kPa					Roof Load, kPa				
		1.4	1.9	2.4	2.8	3.3	1.4	1.9	2.4	2.8	3.3	1.4	1.9	2.4	2.8	3.3
9.14	≤3.0	A	A	A	A	A	A	A	B	B	B	B	B	C	C	C
	3.6	A	A	A	B	B	B	B	B	C	C	C	C	C	C	C
	4.2	B	B	B	B	C	C	C	C	C	C	C	C	C	D	D
	4.8	B	B	C	C	C	C	C	C	C	D	C	D	D	D	—
	6.0	C	C	C	C	C	D	D	D	—	—	—	—	—	—	—
12.1	≤3.0	A	A	A	B	B	B	B	B	C	C	B	C	C	C	C
	3.6	A	A	B	B	B	B	C	C	C	C	C	C	C	D	D
	4.2	B	B	B	C	C	C	C	C	C	D	C	D	D	D	—
	4.8	B	C	C	C	C	C	C	D	D	D	D	D	—	—	—
	6.0	C	C	C	D	D	D	D	—	—	—	—	—	—	—	—
15.2	≤3.0	A	A	B	B	B	B	B	C	C	C	C	C	C	D	D
	3.6	A	B	B	C	C	C	C	C	C	D	C	C	D	D	—
	4.2	B	C	C	C	C	C	C	C	D	D	D	D	D	—	—
	4.8	C	C	C	C	C	C	D	D	D	—	D	—	—	—	—
	6.0	C	C	D	D	—	D	—	—	—	—	—	—	—	—	—
18.2	≤3.0	A	B	B	B	C	B	C	C	C	D	C	C	D	D	—
	3.6	B	B	C	C	C	C	C	C	D	D	C	D	D	—	—
	4.2	B	C	C	C	C	C	C	D	D	—	D	D	—	—	—
	4.8	C	C	C	C	D	D	D	D	—	—	—	—	—	—	—
	6.0	C	D	D	—	—	—	—	—	—	—	—	—	—	—	—
Column 1	2	3	4	5	6	7	8	9	10	11	12	13	14	15	16	17

Legend - Post Sizes:

A = 101.6 mm x 152.4 mm

B = 152.4 mm x 152.4 mm

C = 152.4 mm x 203.2 mm

D = 203.2 mm x 203.2 mm

Notes to Table 1.3.2.F:

- (1) Designs are based on load combinations of total roof load and wind load acting at the same time on a closed building.
- (2) Posts shall be oriented with the long dimension parallel to the building width.
- (3) Bracing systems shall be specified by a competent designer.
- (4) Posts shall be situated on footings and shall be anchored to prevent wind uplift.
- (5) Posts shall be constrained against lateral movement at ground level and at the footing. Concrete floor, splash-rail and uplift anchor help to meet this condition.
- (6) Post designs are based on partial fixity condition due to embedment in soil.
- (7) Footing excavations should be backfilled with parent material unless otherwise specified by a competent designer.

Table 1.3.2.G.
Post Sizes for Knee-Braced Farm Buildings of Low Human Occupancy
 Forming Part of Sentence 1.3.2.(1)

Building Width, m	Wall Height, m	Ungraded Lumber, Full-Dimensioned														
		For Wind Loading $q_{10} \leq 0.30$ kPa														
		Post Spacing, 2.4 m					Post Spacing, 3.6 m					Post Spacing, 4.8 m				
		Roof Load, kPa					Roof Load, kPa					Roof Load, kPa				
		1.4	1.9	2.4	2.8	3.3	1.4	1.9	2.4	2.8	3.3	1.4	1.9	2.4	2.8	3.3
9.14	≤3.0	A	A	A	A	A	A	A	B	B	B	B	B	C	C	C
	3.6	A	A	A	B	B	B	B	B	C	C	B	C	C	C	C
	4.2	B	B	B	B	C	B	C	C	C	C	C	C	C	D	D
	4.8	C	C	C	C	C	C	C	C	C	D	C	C	D	D	—
	6	C	C	C	C	D	C	D	D	—	—	D	—	—	—	—
12.1	≤3.0	A	A	A	B	B	A	B	B	C	C	B	C	C	C	D
	3.6	A	B	B	B	C	B	C	C	C	C	C	C	C	D	D
	4.2	B	B	C	C	C	C	C	C	C	D	C	C	D	D	—
	4.8	C	C	C	C	C	C	C	D	D	D	D	D	—	—	—
	6.0	C	C	C	D	D	D	D	—	—	—	—	—	—	—	—
15.2	≤3.0	A	A	B	B	B	B	B	C	C	C	C	C	C	D	D
	3.6	A	B	B	C	C	C	C	C	C	D	C	C	D	D	—
	4.2	B	C	C	C	C	C	C	D	D	D	C	D	—	—	—
	4.8	C	C	C	C	D	C	D	D	—	—	D	—	—	—	—
	6.0	C	D	D	D	—	D	—	—	—	—	—	—	—	—	—
18.2	≤3.0	A	B	B	C	C	B	C	C	C	D	C	C	D	D	—
	3.6	B	B	C	C	C	C	C	C	D	D	C	D	D	—	—
	4.2	C	C	C	C	D	C	C	D	—	—	D	D	—	—	—
	4.8	C	C	C	D	D	C	D	—	—	—	D	—	—	—	—
	6.0	C	D	—	—	—	—	—	—	—	—	—	—	—	—	—
Column 1	2	3	4	5	6	7	8	9	10	11	12	13	14	15	16	17

Legend - Post Sizes:

A = 101.6 mm x 152.4 mm

B = 152.4 mm x 152.4 mm

C = 152.4 mm x 203.2 mm

D = 203.2 mm x 203.2 mm

Notes to Table 1.3.2.G.:

- (1) Designs are based on load combinations of total roof load and wind load acting at the same time on a closed building.
- (2) Posts shall be oriented with the long dimension parallel to the building width.
- (3) Bracing systems shall be specified by a competent designer.
- (4) Posts shall be situated on footings and shall be anchored to prevent wind uplift.
- (5) Posts shall be constrained against lateral movement at ground level and at the footing. Concrete floor, splash-rail and uplift anchor help to meet this condition.
- (6) Post designs are based on partial fixity condition due to embedment in soil.
- (7) Footing excavations should be backfilled with parent material unless otherwise specified by a competent designer.

Table 1.3.2.H.
Post Sizes for Knee-Braced Farm Buildings of Low Human Occupancy
Forming Part of Sentence 1.3.2.(1)

Building Width, m	Wall Height, m	Ungraded Lumber, Full-Dimensioned														
		For Wind Loading $q_{10} \leq 0.45$ kPa														
		Post Spacing, 2.4 m					Post Spacing, 3.6 m					Post Spacing, 4.8 m				
		Roof Load, kPa					Roof Load, kPa					Roof Load, kPa				
		1.4	1.9	2.4	2.8	3.3	1.4	1.9	2.4	2.8	3.3	1.4	1.9	2.4	2.8	3.3
9.14	≤3.0	A	A	A	A	B	A	B	B	B	C	B	C	C	C	C
	3.6	A	A	B	B	B	B	C	C	C	C	C	C	C	C	D
	4.2	B	B	B	C	C	C	C	C	C	C	C	C	D	D	D
	4.8	C	C	C	C	C	C	C	C	D	D	D	D	D	—	—
	6.0	C	C	C	D	D	D	D	—	—	—	—	—	—	—	—
12.1	≤3.0	A	A	B	B	B	B	B	C	C	C	C	C	C	C	D
	3.6	A	B	B	C	C	C	C	C	C	C	C	C	D	D	D
	4.2	B	C	C	C	C	C	C	C	D	D	C	D	D	—	—
	4.8	C	C	C	C	C	C	D	D	D	—	D	—	—	—	—
	6.0	C	D	D	D	—	—	—	—	—	—	—	—	—	—	—
15.2	≤3.0	A	B	B	B	C	B	C	C	C	C	C	C	D	D	D
	3.6	B	B	C	C	C	C	C	C	D	D	C	D	D	—	—
	4.2	C	C	C	C	C	C	C	D	D	—	D	D	—	—	—
	4.8	C	C	C	D	D	D	D	—	—	—	—	—	—	—	—
	6.0	D	D	D	—	—	—	—	—	—	—	—	—	—	—	—
18.2	≤3.0	A	B	B	C	C	C	C	C	D	D	C	D	D	—	—
	3.6	B	C	C	C	C	C	C	D	D	—	D	D	—	—	—
	4.2	C	C	C	C	C	C	C	D	D	—	D	D	—	—	—
	4.8	C	C	C	C	D	C	D	D	—	—	D	—	—	—	—
	6.0	C	C	D	D	D	D	—	—	—	—	—	—	—	—	—
Column 1	2	3	4	5	6	7	8	9	10	11	12	13	14	15	16	17

Legend - Post Sizes:

A = 101.6 mm x 152.4 mm

B = 152.4 mm x 152.4 mm

C = 152.4 mm x 203.2 mm

D = 203.2 mm x 203.2 mm

Notes to Table 1.3.2.H.:

- (1) Designs are based on load combinations of total roof load and wind load acting at the same time on a closed building.
- (2) Posts shall be oriented with the long dimension parallel to the building width.
- (3) Bracing systems shall be specified by a competent designer.
- (4) Posts shall be situated on footings and shall be anchored to prevent wind uplift.
- (5) Posts shall be constrained against lateral movement at ground level and at the footing. Concrete floor, splash-rail and uplift anchor help to meet this condition.
- (6) Post designs are based on partial fixity condition due to embedment in soil.
- (7) Footing excavations should be backfilled with parent material unless otherwise specified by a competent designer.

Table 1.3.2.I.
Post Sizes for Farm Buildings of Low Human Occupancy (With Second Storey Loading)
 Forming Part of Sentence 1.3.2.(1)

Sidewall Height, m	Total Roof Load, kPa	Spruce-Pine-Fir, No. 1, Dressed (Post and Timber Grades)																Second Storey Plate, kN/m
		Wind load: $q_{10} \leq 0.30$ kPa								Wind load: $q_{10} \leq 0.45$ kPa								
		2.4 m o.c.				3.6 m o.c.				2.4 m o.c.				3.6 m o.c.				
		Building Width, m				Building Width, m				Building Width, m				Building Width, m				
		9.14	12.2	15.2	18.3	9.14	12.2	15.2	18.3	9.14	12.2	15.2	18.3	9.14	12.2	15.2	18.3	
3.0	1.9	A	A	A	A	A	A	B	B	A	A	A	A	A	B	B	B	14.6
	2.4	A	A	A	A	A	B	B	B	A	A	A	B	A	B	B	B	
	2.8	A	A	A	B	A	B	B	C	A	A	B	B	B	B	B	C	
	3.3	A	A	B	B	B	B	B	C	A	A	B	B	B	B	C	C	
3.6	1.9	A	A	A	B	A	B	B	C	A	A	B	B	B	B	C	C	14.6
	2.4	A	A	B	B	B	B	C	C	A	B	B	B	B	C	C	C	
	2.8	A	B	B	B	B	B	C	C	A	B	B	B	B	C	C	C	
	3.3	A	B	B	C	B	C	C	C	B	B	B	C	C	C	C	C	
3.0	1.9	A	A	A	A	A	A	B	B	A	A	A	A	A	A	B	B	7.3
	2.4	A	A	A	A	A	A	B	B	A	A	A	A	A	B	B	B	
	2.8	A	A	A	B	A	B	B	B	A	A	A	B	B	B	B	C	
	3.3	A	A	B	B	B	B	B	C	A	A	B	B	B	B	C	C	
3.6	1.9	A	A	A	B	A	B	B	B	A	A	B	B	B	B	C	C	7.3
	2.4	A	A	B	B	B	B	C	C	A	B	B	B	B	C	C	C	
	2.8	A	A	B	B	B	B	C	C	A	B	B	B	B	C	C	C	
	3.3	A	B	B	B	B	C	C	C	B	B	B	C	C	C	C	C	
3.0	1.9	A	A	A	A	A	A	A	B	A	A	A	A	A	A	B	B	3.6
	2.4	A	A	A	A	A	A	B	B	A	A	A	A	A	B	B	B	
	2.8	A	A	A	B	A	B	B	B	A	A	A	B	B	B	B	C	
	3.3	A	A	A	B	A	B	B	C	A	A	B	B	B	B	C	C	
3.6	1.9	A	A	A	B	A	B	B	B	A	A	A	B	B	B	B	C	3.6
	2.4	A	A	B	B	B	B	B	C	A	A	B	B	B	B	C	C	
	2.8	A	A	B	B	B	B	C	C	A	B	B	B	B	C	C	C	
	3.3	A	B	B	B	B	C	C	C	A	B	B	C	B	C	C	C	
Column 1	2	3	4	5	6	7	8	9	10	11	12	13	14	15	16	17	18	19

Legend - Post Sizes:

A = 89 mm x 140 mm

B = 140 mm x 140 mm

C = 140 mm x 184 mm

Notes to Table 1.3.2.I.:

- (1) Designs are based on load combinations of total roof load, wind load and stored product acting at the same time on a closed building.
- (2) All notes following Table 1.3.2.A. apply, with the following conditions/exceptions:
 - 14.6 kN/m loading: Full 4.8 m sidewall hay/straw storage space above. It is supported by beams spaced at 3.6 m o.c. The outside plate carries a 1.8 m floor width. If the loading is greater, refer to a qualified person for design.
 - 7.3 kN/m loading: Full 2.4 m sidewall hay/straw storage space above or a gambrel roof structure > 9.14 m in total width. Floor support beams as above.
 - 3.6 kN/m loading: Small gambrel roof structure or storage space for light storage. Floor support beams as above.

Table 1.3.2.J.
Round Posts
 Forming Part of Sentence 1.3.2.(1)

Ungraded Lumber Full-dimension Size, mm	Equivalent Diameter Full Size, mm
50.8 x 101.6	101.6
50.8 x 152.4	127.0
50.8 x 203.2	152.4
50.8 x 254.0	177.8
50.8 x 304.8	203.2
76.2 x 304.8	228.6
76.2 x 355.6	254.0
101.6 x 152.4	158.8
101.6 x 304.8	203.2
101.6 x 355.6	279.4
127.0 x 203.2	209.6
127.0 x 254.0	241.3
152.4 x 152.4	190.5
152.4 x 203.2	222.3
152.4 x 254.0	260.4
203.2 x 203.2	247.7
203.2 x 254.0	285.8
203.2 x 304.8	317.5
254.0 x 304.8	342.9
254.0 x 355.6	381.0
Column 1	2

Notes to Table 1.3.2.J.:

- (1) When selecting round, ungraded lumber, ensure that the material is of good quality.
- (2) Any timber that is in contact with ground shall be chemically treated to resist growth of fungus and decay.
- (3) Equivalent diameter indicated in this Table refers to the smallest diameter of a tapering pole.
- (4) Used hydro or telephone poles may be used if they are of good quality and are chemically treated to prevent decay.
- (5) Indicated equivalent diameter will provide bending, shear and deflection resisting capabilities equal to or better than the rectangular section that it replaces.

Table 1.3.3.K.
Common Rafter Sizes for Farm Buildings of Low Human Occupancy
 Forming Part of Sentence 1.3.3.(1)

Rafter Span, m	Spruce-Pine-Fir, No. 1 and No. 2 (Dressed Lumber)														
	Rafter Spacing														
	305 mm					406 mm					610 mm				
	Live Load, kPa					Live Load, kPa					Live Load, kPa				
	1.4	1.9	2.4	2.8	3.3	1.4	1.9	2.4	2.8	3.3	1.4	1.9	2.4	2.8	3.3
2.4	A	A	B	B	B	A	B	B	B	B	B	B	B	B	B
3.0	B	B	B	B	B	B	B	B	B	C	B	B	C	C	D
3.6	B	B	C	C	C	B	C	C	C	C	C	C	D	D	D
4.2	B	C	C	C	C	C	C	C	D	D	C	D	D	E	E
4.8	C	C	D	D	D	C	D	D	E	E	D	E	E	—	—
5.4	C	D	D	D	E	D	D	E	E	—	E	E	—	—	—
6.0	D	D	D	E	—	D	E	E	—	—	E	—	—	—	—
Column 1	2	3	4	5	6	7	8	9	10	11	12	13	14	15	16

Legend - Rafter Sizes:

A = 38 mm x 89 mm C = 38 mm x 184 mm B = 38 mm x 140 mm D = 38 mm x 235 mm E = 38 mm x 286 mm

Notes to Table 1.3.3.K.:

- (1) The rafter span is the unsupported length of the rafter from plate to plate or from plate to ridge. A dead load of 0.24 kPa is incorporated to allow for weight of the roof sheathing and rafter.

Table 1.3.3.L.
Common Rafter Sizes for Farm Buildings of Low Human Occupancy
 Forming Part of Sentence 1.3.3.(1)

Rafter Span, m	Ungraded Lumber, Full-Dimension														
	Rafter Spacing														
	305 mm					406 mm					610 mm				
	Live Load, kPa					Live Load, kPa					Live Load, kPa				
	1.4	1.9	2.4	2.8	3.3	1.4	1.9	2.4	2.8	3.3	1.4	1.9	2.4	2.8	3.3
2.4	A	A	B	B	B	B	B	B	B	C	B	B	C	C	D
3.0	B	B	B	C	C	B	C	C	C	D	C	C	D	D	E
3.6	B	C	C	D	D	C	C	D	D	E	D	D	E	F	F
4.2	C	C	D	D	E	D	D	E	E	F	E	F	F	F	G
4.8	C	D	E	E	F	D	E	F	F	F	F	F	F	G	I
5.4	D	E	F	F	F	E	F	F	F	G	F	G	H	I	—
6.0	E	F	F	F	G	F	F	G	G	I	F	H	I	—	—
Column 1	2	3	4	5	6	7	8	9	10	11	12	13	14	15	16

Legend - Rafter Sizes:

A = 50.8 mm x 101.6 mm D = 50.8 mm x 254.0 mm G = 76.2 mm x 355.6 mm
 B = 50.8 mm x 152.4 mm E = 50.8 mm x 304.8 mm H = 101.6 mm x 304.8 mm
 C = 50.8 mm x 203.2 mm F = 76.2 mm x 304.8 mm I = 101.6 mm x 355.6 mm

Notes to Table 1.3.3.L.:

- (1) The rafter span is the unsupported length of the rafter from plate to plate or from plate to ridge. A dead load of 0.24 kPa is incorporated to allow for weight of the roof sheathing and rafter.

Table 1.3.3.M.
Floor Joists for Farm Buildings of Low Human Occupancy - Intermittent Loads⁽¹⁾
 Forming Part of Sentence 1.3.3.(1)

Joist Span, m	Spruce-Pine-Fir, No. 1 and No. 2 (Dressed Lumber)																	
	Joist Spacing																	
	305 mm						406 mm						610 mm					
	Live Load, kPa						Live Load, kPa						Live Load, kPa					
	1.9	2.8	3.8	4.8	6.7	8.6	1.9	2.8	3.8	4.8	6.7	8.6	1.9	2.8	3.8	4.8	6.7	8.6
2.4	A	B	B	B	B	C	B	B	B	B	C	C	B	B	B	C	D	D
3.0	B	B	B	C	C	D	B	B	C	C	D	D	B	C	C	D	E	—
3.6	B	C	C	C	D	D	C	C	C	D	E	E	C	D	D	E	—	—
4.2	C	C	D	D	E	E	C	D	D	E	—	—	D	D	E	—	—	—
4.8	C	D	D	E	—	—	D	D	E	E	—	—	D	E	—	—	—	—
Column 1	2	3	4	5	6	7	8	9	10	11	12	13	14	15	16	17	18	19

Legend - Joist Sizes:

A = 38 mm x 89 mm B = 38 mm x 140 mm C = 38 mm x 184 mm D = 38 mm x 235 mm E = 38 mm x 286 mm

Notes to Table 1.3.3.M.:

- (1) Loads are applied to the floor intermittently. (When loads are applied for extended periods of time, use Table 1.3.3.N.).
- (2) A dead load of 0.48 kPa is incorporated to allow for the dead weight of the floor system.

Table 1.3.3.N.
Floor Joists for Farm Buildings of Low Human Occupancy - Continuous Loads⁽¹⁾
 Forming Part of Sentence 1.3.3.(1)

Joist Span, m	Spruce-Pine-Fir, No. 1 and No. 2 (Dressed Lumber)																	
	Joist Spacing																	
	305 mm						406 mm						610 mm					
	Live Load, kPa						Live Load, kPa						Live Load, kPa					
	1.9	2.8	3.8	4.8	6.7	8.6	1.9	2.8	3.8	4.8	6.7	8.6	1.9	2.8	3.8	4.8	6.7	8.6
2.4	A	B	B	B	C	C	B	B	B	C	D	E	B	C	C	D	—	—
3.0	B	B	C	C	D	E	B	C	C	D	E	—	C	D	D	E	—	—
3.6	B	C	D	D	E	—	C	D	D	E	—	—	D	E	—	—	—	—
4.2	C	D	D	E	—	—	D	E	E	—	—	—	E	—	—	—	—	—
4.8	D	D	E	—	—	—	D	E	—	—	—	—	—	—	—	—	—	—
Column 1	2	3	4	5	6	7	8	9	10	11	12	13	14	15	16	17	18	19

Legend - Joist Sizes:

A = 38 mm x 89 mm B = 38 mm x 140 mm C = 38 mm x 184 mm D = 38 mm x 235 mm E = 38 mm x 286 mm

Notes to Table 1.3.3.N.:

- (1) For use of floors that support hay, straw, grain or other continuous loads.
- (2) A dead load of 0.48 kPa is incorporated to allow for the dead weight of the floor system.

Table 1.3.3.O.
Built-up Wood Beam Sizes for Farm Buildings of Low Human Occupancy - Intermittent Loads⁽¹⁾
 Forming Part of Sentence 1.3.3.(1)

Beam Span, m	Spruce-Pine-Fir, No. 1 and No. 2 (Dressed Lumber)										
	Total Load on Beam, kN/m										
	5.84	8.76	11.67	14.59	17.51	20.43	23.35	26.27	29.19	32.11	35.03
1.8	A	A	A	B	B	D	D	G	G	J	L
2.4	A	A	B	D	E	H	J	L	—	—	—
3.0	A	C	E	H	J	K	—	—	—	—	—
3.6	C	H	J	L	—	—	—	—	—	—	—
4.2	E	J	L	—	—	—	—	—	—	—	—
4.8	I	L	—	—	—	—	—	—	—	—	—
Column 1	2	3	4	5	6	7	8	9	10	11	12

Legend - Beam Sizes:

A = 3 - 38 mm x 184 mm	E = 3 - 38 mm x 286 mm	I = 4 - 38 mm x 286 mm
B = 4 - 38 mm x 184 mm	F = 4 - 38 mm x 235 mm	J = 6 - 38 mm x 235 mm
C = 3 - 38 mm x 235 mm	G = 6 - 38 mm x 184 mm	K = 5 - 38 mm x 286 mm
D = 5 - 38 mm x 184 mm	H = 5 - 38 mm x 235 mm	L = 6 - 38 mm x 286 mm

Notes to Table 1.3.3.O.:

- (1) Loads are applied to the beam intermittently.
- (2) A dead load of 0.584 kN/m is assumed for all beams.
- (3) Floors systems supporting heavy loads over larger spans will require the use of steel beams or other specialized materials.

Table 1.3.3.P.
Built-up Wood Beam Sizes for Farm Buildings of Low Human Occupancy - Continuous Loads⁽¹⁾
 Forming Part of Sentence 1.3.3.(1)

Beam Span, m	Spruce-Pine-Fir, No. 1 and No. 2 (Dressed Lumber)						
	Total Load on Beam, kN/m						
	5.84	8.76	11.67	14.59	17.51	20.43	23.35
1.8	A	A	B	D	G	J	L
2.4	A	C	E	J	L	—	—
3.0	D	H	J	L	—	—	—
3.6	H	K	—	—	—	—	—
4.2	K	—	—	—	—	—	—
4.8	L	—	—	—	—	—	—
Column 1	2	3	4	5	6	7	8

Legend - Beam Sizes:

A = 3 - 38 mm x 184 mm	E = 3 - 38 mm x 286 mm	I = 4 - 38 mm x 286 mm
B = 4 - 38 mm x 184 mm	F = 4 - 38 mm x 235 mm	J = 6 - 38 mm x 235 mm
C = 3 - 38 mm x 235 mm	G = 6 - 38 mm x 184 mm	K = 5 - 38 mm x 286 mm
D = 5 - 38 mm x 184 mm	H = 5 - 38 mm x 235 mm	L = 6 - 38 mm x 286 mm

Notes to Table 1.3.3.P.:

- (1) For use of floors that support hay, straw, grain or other continuous loads.
- (2) A dead load of 0.48 kPa is assumed for all beams.
- (3) Floor systems supporting heavy loads over larger spans will require use of steel beams or other specialized materials.

Table 1.3.3.Q.
Ungraded Lumber, Full-Dimension Roof Beam Sizes for Farm Buildings of Low Human Occupancy⁽¹⁾
 Forming Part of Sentence 1.3.3.(1)

Beam Span, m	Total Load on Built-up Wood Beam, kN/m							
	5.84	8.76	11.67	14.59	17.51	20.43	23.35	26.27
1.8	A	A	B	C	D	F	G	H
2.4	B	D	E	H	I	J	—	—
3.0	D	G	I	—	—	—	—	—
3.6	G	J	—	—	—	—	—	—
4.2	J	—	—	—	—	—	—	—
Column 1	2	3	4	5	6	7	8	9

Legend - Built-up Wood Beam Sizes:

A = 3 - 50.8 mm x 203.2 mm
 B = 4 - 50.8 mm x 203.2 mm
 C = 3 - 50.8 mm x 254.0 mm

D = 5 - 50.8 mm x 203.2 mm
 E = 6 - 50.8 mm x 203.2 mm
 F = 4 - 50.8 mm x 254.0 mm

G = 5 - 50.8 mm x 254.0 mm
 H = 4 - 50.8 mm x 304.8 mm
 I = 5 - 50.8 mm x 304.8 mm
 J = 6 - 50.8 mm x 304.8 mm

Notes to Table 1.3.3.Q.:

- (1) Ungraded lumber, full-dimension, built-up wood beam.
- (2) A dead load of 0.584 kN/m is assumed.
- (3) Beams are sized for roof load only.

Table 1.3.3.R.
Ungraded Lumber, Full-Dimension Roof Beam Sizes for Farm Buildings of Low Human Occupancy⁽¹⁾
 Forming Part of Sentence 1.3.3.(1)

Beam Span, m	Total Load on Sawn Beam, kN/m							
	5.84	8.76	11.67	14.59	17.51	20.43	23.35	26.27
1.8	A	A	B	C	D	E	F	G
2.4	A	B	D	D	F	G	—	—
3.0	C	D	E	F	—	—	—	—
3.6	D	F	G	—	—	—	—	—
4.2	E	G	—	—	—	—	—	—
Column 1	2	3	4	5	6	7	8	9

Legend - Sawn Beam Sizes:

A = 127.0 mm x 203.2 mm
 B = 127.0 mm x 254.0 mm
 C = 152.4 mm x 254.0 mm

D = 203.2 mm x 254.0 mm
 E = 203.2 mm x 304.8 mm
 F = 254.0 mm x 304.8 mm

G = 254.0 mm x 355.6 mm

Notes to Table 1.3.3.R.:

- (1) Ungraded lumber, full-dimension, sawn wood beam.
- (2) A dead load of 0.584 kN/m is assumed.
- (3) Beams are sized for roof load only.

Table 1.3.3.S.
Roof Plate-Beams and Lintels for Farm Buildings of Low Human Occupancy
 Forming Part of Sentence 1.3.3.(1)

Building Width, m	Spruce-Pine-Fir, No. 1 and No. 2 (Dressed Lumber)								
	Total Roof Load, kPa, with Post Spacing at 2.4 m								
	A	B	C	D	E	F	G	H	I
7.3	1.67	2.77	3.68	2.49	4.11	5.50	3.35	5.55	7.42
8.5	1.43	2.34	3.16	2.15	3.54	4.74	2.87	4.74	6.36
9.7	1.24	2.05	2.77	1.86	3.11	4.11	2.53	4.16	5.55
10.9	—	1.81	2.44	1.67	2.72	3.68	2.25	3.68	4.93
12.1	—	1.62	2.20	1.48	2.49	3.30	2.01	3.30	4.45
13.4	—	1.48	2.01	1.34	2.25	3.01	1.81	3.01	4.02
14.6	—	1.38	1.81	1.24	2.05	2.72	1.67	2.77	3.68
15.8	—	1.24	1.67	—	1.91	2.53	1.53	2.53	3.40
17.0	—	—	1.58	—	1.77	2.34	1.43	2.39	3.16
18.2	—	—	1.48	—	1.62	2.20	1.34	2.20	2.96
Building Width, m	Total Roof Load, kPa, with Post Spacing at 3.0 m								
	A	B	C	D	E	F	G	H	I
	7.3	—	1.72	2.29	1.53	2.58	3.44	2.10	3.44
8.5	—	1.48	1.96	1.34	2.20	2.96	1.77	2.96	3.97
9.7	—	1.29	1.72	—	1.91	2.58	1.58	2.58	3.44
10.9	—	—	1.53	—	1.72	2.29	1.38	2.29	3.06
12.1	—	—	1.38	—	1.53	2.05	1.24	2.05	2.77
13.4	—	—	1.24	—	1.38	1.86	—	1.86	2.53
14.6	—	—	—	—	1.29	1.72	—	1.72	2.29
15.8	—	—	—	—	—	1.58	—	1.58	2.10
17.0	—	—	—	—	—	1.48	—	1.48	1.96
18.2	—	—	—	—	—	1.38	—	1.38	1.81
Building Width, m	Total Roof Load, kPa, with Post Spacing at 3.6 m								
	A	B	C	D	E	F	G	H	I
	7.3	—	1.38	1.81	1.24	2.05	2.72	1.67	2.77
8.5	—	—	1.58	—	1.77	2.34	1.43	2.39	3.16
9.7	—	—	1.38	—	1.53	2.05	1.24	2.05	2.77
10.9	—	—	1.19	—	1.38	1.81	—	1.81	2.44
12.1	—	—	—	—	1.24	1.62	—	1.67	2.20
13.4	—	—	—	—	—	1.48	—	1.48	2.01
14.6	—	—	—	—	—	1.38	—	1.38	1.81
15.8	—	—	—	—	—	1.24	—	1.29	1.67
17.0	—	—	—	—	—	—	—	—	1.58
18.2	—	—	—	—	—	—	—	—	1.48
Column 1	2	3	4	5	6	7	8	9	10

Legend - Roof Plate-Beam and Lintel Sizes:

A = 2 - 38 mm x 184 mm

B = 3 - 38 mm x 184 mm

C = 4 - 38 mm x 184 mm

D = 2 - 38 mm x 235 mm

E = 3 - 38 mm x 235 mm

F = 4 - 38 mm x 235 mm

G = 2 - 38 mm x 286 mm

H = 3 - 38 mm x 286 mm

I = 4 - 38 mm x 286 mm

Notes to Table 1.3.3.S.:

(1) Trusses are at 1.2 m on centres.

(2) Plate-beam/lintel loading can be very significant.

(3) Specifications for anchorage at supporting posts must be specified by a competent designer.

Table 1.3.3.T.
Roof Plate-Beams and Lintels for Farm Buildings of Low Human Occupancy
Forming Part of Sentence 1.3.3.(1)

Building Width, m	Ungraded Lumber-Full Dimension								
	Total Roof Load, kPa, with Post Spacing at 2.4 m								
	A	B	C	D	E	F	G	H	I
7.3	—	1.72	2.29	1.48	2.44	3.25	1.91	3.20	4.26
8.5	—	1.43	1.96	1.24	2.10	2.77	1.67	2.72	3.68
9.7	—	1.29	1.72	—	1.81	2.44	1.43	2.39	3.20
10.9	—	—	1.53	—	1.62	2.15	1.29	2.15	2.87
12.1	—	—	1.34	—	1.48	1.96	—	1.91	2.58
13.4	—	—	1.24	—	1.34	1.77	—	1.72	2.34
14.6	—	—	—	—	1.19	1.62	—	1.58	2.15
15.8	—	—	—	—	—	1.48	—	1.48	1.96
17.0	—	—	—	—	—	1.38	—	1.38	1.81
18.2	—	—	—	—	—	1.29	—	1.29	1.72
Building Width, m	Total Roof Load, kPa, with Post Spacing at 3.0 m								
	A	B	C	D	E	F	G	H	I
7.3	—	—	1.43	—	1.53	2.05	1.19	2.01	2.68
8.5	—	—	1.19	—	1.29	1.72	—	1.72	2.29
9.7	—	—	—	—	—	1.53	—	1.48	2.01
10.9	—	—	—	—	—	1.34	—	1.34	1.77
12.1	—	—	—	—	—	1.19	—	—	1.58
13.4	—	—	—	—	—	—	—	—	1.43
14.6	—	—	—	—	—	—	—	—	1.34
15.8	—	—	—	—	—	—	—	—	1.24
17.0	—	—	—	—	—	—	—	—	—
18.2	—	—	—	—	—	—	—	—	—
Building Width, m	Total Roof Load, kPa, with Post Spacing at 3.6 m								
	A	B	C	D	E	F	G	H	I
7.3	—	—	—	—	1.19	1.62	—	1.58	2.15
8.5	—	—	—	—	—	1.38	—	1.38	1.81
9.7	—	—	—	—	—	1.19	—	—	1.58
10.9	—	—	—	—	—	—	—	—	1.43
12.1	—	—	—	—	—	—	—	—	1.29
13.4	—	—	—	—	—	—	—	—	—
14.6	—	—	—	—	—	—	—	—	—
15.8	—	—	—	—	—	—	—	—	—
17.0	—	—	—	—	—	—	—	—	—
18.2	—	—	—	—	—	—	—	—	—
Column 1	2	3	4	5	6	7	8	9	10

Legend - Roof Plate-Beam and Lintel Sizes:

A = 2 - 50.8 mm x 203.2 mm

B = 3 - 50.8 mm x 203.2 mm

C = 4 - 50.8 mm x 203.2 mm

D = 2 - 50.8 mm x 254.0 mm

E = 3 - 50.8 mm x 254.0 mm

F = 4 - 50.8 mm x 254.0 mm

G = 2 - 50.8 mm x 304.8 mm

H = 3 - 50.8 mm x 304.8 mm

I = 4 - 50.8 mm x 304.8 mm

Notes to Table 1.3.3.T.:

(1) Trusses are at 1.2 m on centres.

(2) Plate-beam/lintel loading can be very significant.

(3) Specifications for anchorage at supporting posts must be specified by a competent designer.

Table 1.3.4.U.
Stud Sizes for Farm Buildings of Low Human Occupancy (Single Storey)
 Forming Part of Sentence 1.3.4.(1)

Sidewall Height, m	Total Roof Load, kPa	Spruce-Pine-Fir, No. 1 and No. 2 (Dressed Lumber)															
		Wind Load: $q_{10} \leq 0.30$ kPa								Wind Load: $q_{10} \leq 0.45$ kPa							
		406 mm o.c.				610 mm o.c.				406 mm o.c.				610 mm o.c.			
		Building Width, m				Building Width, m				Building Width, m				Building Width, m			
		9.14	12.2	15.2	18.3	9.14	12.2	15.2	18.3	9.14	12.2	15.2	18.3	9.14	12.2	15.2	18.3
3.0	1.9	A	A	A	A	A	A	A	B	A	A	A	A	A	A	A	B
	2.4	A	A	A	A	A	A	B	B	A	A	A	A	A	A	B	B
	2.8	A	A	A	A	A	A	B	B	A	A	A	A	A	B	B	B
	3.3	A	A	A	B	A	B	B	B	A	A	A	B	A	B	B	B
3.6	1.9	A	A	A	B	A	B	B	B	A	A	A	B	B	B	B	B
	2.4	A	A	B	B	B	B	B	B	A	A	B	B	B	B	B	B
	2.8	A	B	B	B	B	B	B	B	A	B	B	B	B	B	B	B
	3.3	A	B	B	B	B	B	B	B	A	B	B	B	B	B	B	B
4.2	1.9	B	B	B	B	B	B	B	B	B	B	B	B	B	B	B	B
	2.4	B	B	B	B	B	B	B	B	B	B	B	B	B	B	B	B
	2.8	B	B	B	B	B	B	B	B	B	B	B	B	B	B	B	B
	3.3	B	B	B	B	B	B	B	B	B	B	B	B	B	B	B	B
4.8	1.9	B	B	B	B	B	B	B	B	B	B	B	B	B	B	B	B
	2.4	B	B	B	B	B	B	B	B	B	B	B	B	B	B	B	C
	2.8	B	B	B	B	B	B	B	C	B	B	B	B	B	B	C	C
	3.3	B	B	B	B	B	B	C	C	B	B	B	B	B	B	C	C
Column 1	2	3	4	5	6	7	8	9	10	11	12	13	14	15	16	17	18

Legend - Stud Sizes:

A = 38 mm x 89 mm

B = 38 mm x 140 mm

C = 38 mm x 184 mm or double 38 mm x 140 mm under the trusses, with an intermediate 38 mm x 140 mm stud at 610 mm.

Notes to Table 1.3.4.U.:

- (1) Designs are based on load combinations of total roof load and wind load acting at the same time on a closed building.
- (2) It is assumed that the double top plate is rigid enough to cause load sharing amongst all studs regardless of the spacing 406 mm or 610 mm.
- (3) Solid bridging shall be used on all walls as follows:
 - ≤ 3.0 m: 1 row at mid-height.
 - 3.6 m - 4.2 m: 2 rows at third-points.
 - 4.8 m: 3 rows at quarter-points.
- (4) Wind bracing shall not impose additional bending forces onto the stud.

Table 1.3.4.V.
Stud Sizes for Farm Buildings of Low Human Occupancy (With Second Storey Loading)
 Forming Part of Sentence 1.3.4.(1)

Sidewall Height, m	Total Roof Load, kPa	Spruce-Pine-Fir, No. 1 and No. 2 (Dressed Lumber)																Second Storey Plate, kN/m
		Wind Load: $q_{10} \leq 0.30$ kPa								Wind Load: $q_{10} \leq 0.45$ kPa								
		406 mm o.c.				610 mm o.c.				406 mm o.c.				610 mm o.c.				
		Building Width, m				Building Width, m				Building Width, m				Building Width, m				
		9.14	12.2	15.2	18.3	9.14	12.2	15.2	18.3	9.14	12.2	15.2	18.3	9.14	12.2	15.2	18.3	
3.0	1.9	B	B	B	B	B	B	B	B	B	B	B	B	B	B	B	B	14.6
	2.4	B	B	B	B	B	B	B	B	B	B	B	B	B	B	B	B	
	2.8	B	B	B	B	B	B	B	B	B	B	B	B	B	B	B	B	
	3.3	B	B	B	B	B	B	B	B	B	B	B	B	B	B	B	B	
3.6	1.9	B	B	B	B	B	B	B	C	B	B	B	B	B	B	C	C	14.6
	2.4	B	B	B	B	B	B	C	C	B	B	B	B	B	C	C	C	
	2.8	B	B	B	B	B	B	C	C	B	B	B	B	B	C	C	C	
	3.3	B	B	B	B	B	C	C	C	B	B	B	B	C	C	C	C	
3.0	1.9	A	A	B	B	B	B	B	B	B	B	B	B	B	B	B	B	7.3
	2.4	A	B	B	B	B	B	B	B	B	B	B	B	B	B	B	B	
	2.8	A	B	B	B	B	B	B	B	B	B	B	B	B	B	B	B	
	3.3	B	B	B	B	B	B	B	B	B	B	B	B	B	B	B	B	
3.6	1.9	B	B	B	B	B	B	B	B	B	B	B	B	B	B	B	B	7.3
	2.4	B	B	B	B	B	B	B	B	B	B	B	B	B	B	B	B	
	2.8	B	B	B	B	B	B	B	B	B	B	B	B	B	B	B	B	
	3.3	B	B	B	B	B	B	B	B	B	B	B	B	B	B	B	C	
3.0	1.9	A	A	A	A	A	B	B	B	A	A	A	A	B	B	B	B	3.6
	2.4	A	A	A	B	B	B	B	B	A	A	A	A	B	B	B	B	
	2.8	A	A	B	B	B	B	B	B	A	A	B	B	B	B	B	B	
	3.3	A	A	B	B	B	B	B	B	A	B	B	B	B	B	B	B	
3.6	1.9	A	B	B	B	B	B	B	B	B	B	B	B	B	B	B	B	3.6
	2.4	B	B	B	B	B	B	B	B	B	B	B	B	B	B	B	B	
	2.8	B	B	B	B	B	B	B	B	B	B	B	B	B	B	B	B	
	3.3	B	B	B	B	B	B	B	B	B	B	B	B	B	B	B	B	
Column 1	2	3	4	5	6	7	8	9	10	11	12	13	14	15	16	17	18	19

Legend - Stud Sizes:

- A = 38 mm x 89 mm
- B = 38 mm x 140 mm
- C = 38 mm x 184 mm or double 38 mm x 140 mm

Notes to Table 1.3.4.V.:

- (1) Design is based on load combinations of total roof load, wind load and stored product acting at the same time on a closed building.
- (2) All notes following Table 1.3.4.U. apply, with the following conditions/exceptions:
 - 14.6 kN/m loading: Full 4.8 m sidewall hay/straw storage space above. It is supported by beams spaced at 3.6 m o.c. The outside plate carries a 1.8 m floor width. If the loading is greater, refer to a qualified person for design.
 - 7.3 kN/m loading: Full 2.4 m sidewall hay/straw storage space above or a gambrel roof structure >9.14 m in total width. Floor support beams as above.
 - 3.6 kN/m loading: Small gambrel roof structure or storage space for light storage. Floor support beams as above.

Table 1.3.4.W.
Stud Sizes for Farm Buildings of Low Human Occupancy (Single Storey)
 Forming Part of Sentence 1.3.4.(1)

Sidewall Height, m	Total Roof Load, kPa	Ungraded Lumber, Full-Dimensioned															
		Wind Load: $q_{10} \leq 0.30$ kPa								Wind Load: $q_{10} \leq 0.45$ kPa							
		406 mm o.c.				610 mm o.c.				406 mm o.c.				610 mm o.c.			
		Building Width, m				Building Width, m				Building Width, m				Building Width, m			
		9.14	12.2	15.2	18.3	9.14	12.2	15.2	18.3	9.14	12.2	15.2	18.3	9.14	12.2	15.2	18.3
3.0	1.9	A	A	A	A	A	A	A	B	A	A	A	A	A	A	B	B
	2.4	A	A	A	A	A	A	B	B	A	A	A	A	A	B	B	B
	2.8	A	A	A	A	A	B	B	B	A	A	A	B	B	B	B	B
	3.3	A	A	A	B	A	B	B	B	A	A	A	B	A	B	B	B
3.6	1.9	A	A	A	B	A	B	B	B	A	A	A	B	B	B	B	B
	2.4	A	A	B	B	B	B	B	B	A	A	B	B	B	B	B	B
	2.8	A	B	B	B	B	B	B	B	A	B	B	B	B	B	B	B
	3.3	A	B	B	B	B	B	B	B	B	B	B	B	B	B	B	C
4.2	1.9	B	B	B	B	B	B	B	B	B	B	B	B	B	B	B	B
	2.4	B	B	B	B	B	B	B	B	B	B	B	B	B	B	B	C
	2.8	B	B	B	B	B	B	B	C	B	B	B	B	B	B	C	C
	3.3	B	B	B	B	B	B	C	C	B	B	B	B	B	C	C	C
4.8	1.9	B	B	B	B	B	B	B	C	B	B	B	B	B	B	C	C
	2.4	B	B	B	B	B	B	C	C	B	B	B	B	B	C	C	C
	2.8	B	B	B	B	B	B	C	C	B	B	B	C	C	C	C	C
	3.3	B	B	B	B	B	C	C	C	B	B	B	C	C	C	C	C
Column 1	2	3	4	5	6	7	8	9	10	11	12	13	14	15	16	17	18

Legend - Stud Sizes:

A = 50.8 mm x 101.6 mm

B = 50.8 mm x 152.4 mm

C = 50.8 mm x 203.2 mm or double 50.8 mm x 152.4 mm under the trusses, with an intermediate 50.8 mm x 152.4 mm stud at 610 mm

Notes to Table 1.3.4.W.:

- (1) Designs are based on load combinations of total roof load and wind load acting at the same time on a closed building.
- (2) It is assumed that the double top plate is rigid enough to cause load sharing amongst all studs regardless of the spacing 406 mm or 610 mm.
- (3) Solid bridging shall be used on all walls as follows:
 - ≤ 3.0 m: 1 row at mid-height.
 - 3.6 m to 4.2 m: 2 rows at third-points.
 - 4.8 m: 3 rows at quarter-points.
- (4) Wind bracing shall not impose additional bending forces onto the stud.

MMA Supplementary Standard SB-12

Energy Efficiency For Housing

July 7, 2016 update

COMMENCEMENT

MMAH Supplementary Standard SB-12 comes into force on the 1st day of January, 2014.

- m1** Ruling of the Minister of Municipal Affairs and Housing (Minister's Ruling) MR-13-S-24 takes effect on the 1st day of January, 2014.
- r5** SB-12 as amended by Ontario Regulation 191/14 comes into force on the 1st day of January, 2015.
- m3** Ruling of the Minister of Municipal Affairs (Minister's Ruling) MR-16-S-26 takes effect on 7th day of July, 2016.

EDITORIAL

- e2** Editorial correction issued for January 1st, 2014.
- e4** Editorial correction issued for July 7th, 2016.

© Copyright

© Copyright Queen's Printer for Ontario 2016.

All rights reserved.

Questions regarding copyright, including reproduction and distribution, may be directed to the Director,
Building and Development Branch of the Ministry of Municipal Affairs.

m₃ SB-12 Energy Efficiency for Housing

Chapter 1 General

1.1.	Scope	
1.1.1.	Energy Efficiency Compliance.....	5
1.2.	Application	
1.2.1.	Application of Supplementary Standard SB-12	6
1.3.	Terms and Abbreviations	
1.3.1.	Definitions of Words and Phrases.....	6
1.3.2.	Symbols and Other Abbreviations	6
1.4.	Referenced Documents and Organizations	
1.4.1.	Referenced Documents	7
1.4.2.	Abbreviations	8

Chapter 2 Acceptable Solutions for Energy Efficiency Compliance Before January 1, 2017

2.1.	Methods for Achieving Energy Efficiency Compliance	
2.1.1.	Prescriptive Compliance Packages.....	9
2.1.2.	Performance Compliance	24
2.1.3.	Other Acceptable Compliance Methods	25

Chapter 3 Acceptable Solutions for Energy Efficiency Compliance After December 31, 2016

3.1.	Methods for Achieving Energy Efficiency Compliance	
3.1.1.	Prescriptive Compliance Packages.....	26
3.1.2.	Performance Compliance	50
3.1.3.	Other Acceptable Compliance Methods	52

FOREWORD¹

This Supplementary Standard includes design options regarding the energy efficiency of a building or part of a building of residential occupancy that is within the scope of Part 9 and is intended for occupancy on a continuing basis during the winter months. Conformance with the options in this Supplementary Standard is one method of demonstrating compliance with the requirements in Sentences 12.2.1.1.(3) and 12.2.1.2.(3) of the Building Code (Ontario Regulation 332/12). The options in this Supplementary Standard are intended to recognize the needs of consumers and the building industry for predictable prescriptive and flexible performance-based solutions. Two sets of options are contained in this Supplementary Standard, one that is applicable to construction for which a permit has been applied for before January 1, 2017 and the other that is applicable to permit applications made after December 31, 2016.

The first edition of this Supplementary Standard was published in 2009. The energy efficiency levels achieved in that edition were intended to meet or exceed, on a systematic basis, the EnerGuide 80 level of energy efficiency that would be met by model analogues evaluated against the NRCan “EnerGuide for New Houses: Administrative and Technical Procedures” (2005). The editions published in 2012 and 2013 included certain trade-off options in recognition of the Energy Star program that expanded the number of building component and assembly permutations considered to represent acceptable solutions. The September 2013 also included a new “Chapter 3” with compliance packages that demonstrated how to achieve an additional energy efficiency level increase of 15% over the requirements that took effect on January 1, 2012.

This July 7th, 2016 update of the Supplementary Standard is primarily intended to update the compliance packages set out in Chapter 3. Changes include the identification of credits based on airtightness. The compliance packages and options described in Chapter 3 are applicable to building permits applied for after December 31, 2016. Other changes include the recognition of the technical requirements of Energy Star and R2000 programs as design options for meeting the energy efficiency requirements of the Building Code.

Labelling is not required to demonstrate compliance with this Supplementary Standard.

¹ Unless otherwise indicated, all Building Code references in this foreword refer to provisions located in Division B of the Building Code.

SUMMARY OF THE CONTENTS OF SB-12

Chapter 1: General

This Chapter sets out the scope and application of this Supplementary Standard.

Chapter 2: Acceptable Solutions for Achieving Energy Efficiency Compliance Before January 1, 2017.

This Chapter contains acceptable solutions for achieving energy efficiency compliance with Clause 12.2.1.1.(3)(b) of Division B of the Building Code and applies to construction for which a permit has been applied for before January 1, 2017. Conformance with one of the prescriptive compliance packages in Subsection 2.1.1., the performance compliance method in Subsection 2.1.2. or Energy Star requirements as specified in Subsection 2.1.3. of this Supplementary Standard will achieve an energy efficiency performance level that is intended to meet or exceed, on a systemic basis, the level that would be met by model analogues evaluated against the EnerGuide Rating System-2005.

Chapter 3: Acceptable Solutions for Achieving Energy Efficiency Compliance After December 31, 2016.

This Chapter contains acceptable solutions for achieving energy efficiency compliance with Clause 12.2.1.2.(3)(b) of Division B of the Building Code and applies to construction of buildings for which a permit has been applied for after December 31, 2016. Conformance with one of the prescriptive compliance packages in Subsection 3.1.1., the performance compliance method in Subsection 3.1.2. or Energy Star or R2000 requirements as specified in Subsection 3.1.3. of this Supplementary Standard is intended to achieve, on a systemic basis, an energy efficiency performance level that exceeds the energy efficiency requirements of Sentence 12.2.1.1.(3) of Division B of the Building Code by 15%.

Chapter 1

General

Section 1.1. Scope

1.1.1. Energy Efficiency Compliance

1.1.1.1. Energy Efficiency

- (1) This Section is concerned with the energy used by *buildings* as a result of
 - (a) the design and *construction* of the *building* envelope, and
 - (b) the design and *construction* or specification of systems and equipment for
 - (i) heating, ventilating or *air-conditioning*, and
 - (ii) service water heating.
- (2) Compliance with Chapters 1 and 2 of this Supplementary Standard shall be deemed to meet the energy efficiency requirements in accordance with Sentence 12.2.1.1.(3) of Division B of the *Building Code*.
- (3) Compliance with Chapters 1 and 3 of this Supplementary Standard shall be deemed to meet the energy efficiency requirements in accordance with Sentence 12.2.1.2.(3) of Division B of the *Building Code*.
- (4) The energy efficiency of existing *buildings* shall comply with
 - (a) Part 10 of Division B of the *Building Code* with respect to change of use, or
 - (b) Part 11 of Division B of the *Building Code* for renovation.

1.1.1.2. Compliance Options Before January 1, 2017

- (1) The energy efficiency of a *building* or part of a *building* of *residential occupancy* that is within the scope of Part 9 of Division B of the *Building Code* and is intended for occupancy on a continuing basis during the winter months shall comply with
 - (a) Subsection 2.1.1. (Prescriptive Compliance Packages) of Chapter 2,
 - (b) Subsection 2.1.2. (Performance Compliance) of Chapter 2, or
 - (c) Subsection 2.1.3. (Other Acceptable Compliance Methods) of Chapter 2.
- (2) Factory-built modular homes manufactured before January 1, 2012 in accordance with the *Building Code* as it read on December 31, 2011 shall be deemed to be in compliance with Sentence (1).

1.1.1.3. Compliance Options After December 31, 2016

- (1) The energy efficiency of a *building* or part of a *building* of *residential occupancy* that is within the scope of Part 9 of Division B of the *Building Code* and is intended for occupancy on a continuing basis during the winter months shall comply with
 - (a) Subsection 3.1.1. (Prescriptive Compliance Packages) of Chapter 3,
 - (b) Subsection 3.1.2. (Performance Compliance) of Chapter 3, or
 - (c) Subsection 3.1.3. (Other Acceptable Compliance Methods) of Chapter 3.
- (2) Factory-built modular homes manufactured before January 1, 2017 in accordance with the *Building Code* as it read on December 31, 2016 shall be deemed to be in compliance with Sentence (1).

Section 1.2. Application

1.2.1. Application of Supplementary Standard SB-12

1.2.1.1. Energy Efficiency Design

(1) The energy efficiency of a *building* or part of a *building of residential occupancy* that is within the scope of Part 9 of Division B of the *Building Code* and is intended for occupancy on a continuing basis during the winter months shall comply with this Supplementary Standard in accordance with Subsection 12.2.1. of Division B of the *Building Code*.

Section 1.3. Terms and Abbreviations

1.3.1. Definitions of Words and Phrases

1.3.1.1. Non-Defined Terms

(1) Definitions of words and phrases used in this Supplementary Standard that are not included in the list of definitions in Articles 1.4.1.2. and 1.4.1.3. of Division A of the *Building Code* and are not defined in another provision of the *Building Code* shall have the meanings that are commonly assigned to them in the context in which they are used, taking into account the specialized use of terms by the various trades and professions to which the terminology applies.

1.3.1.2. Defined Terms

(1) Each of the words and terms in italics in this Supplementary Standard has the same meaning as in subsection 1(1) of the *Building Code Act, 1992* or Sentence 1.4.1.2.(1) of Division A of the *Building Code*.

(2) In this Supplementary Standard,

common space means all spaces required to be *conditioned spaces* in accordance with the requirements of the *Building Code* that are not within a *suite* but does not include crawl spaces and *vertical service spaces*;

effective RSI value means the effective thermal resistance, which is the inverse of the *overall thermal transmittance* of a *building* assembly, in $(\text{m}^2 \cdot \text{K})/\text{W}$; (See Appendix A.)

fenestration means a *building* envelope assembly that transfers visible light, such as a window, clerestory, skylight, translucent wall panel, glass block assembly, transom, sidelight, sliding or swinging glass door, or glazed insert in a door, and includes the frames and other components of the assembly;

overall coefficient of heat transfer means *overall thermal transmittance* of *fenestration* and, for greater certainty, includes all components of *fenestration*;

e4 *overall thermal transmittance* means the rate, in $\text{W}/(\text{m}^2 \cdot \text{K})$, at which heat is transferred through all components of a *building* envelope assembly that is subject to temperature differences and includes interior and exterior air films that are in contact with the assembly, but does not include exterior air films where the assembly is in contact with *soil*.

1.3.2. Symbols and Other Abbreviations

1.3.2.1. Symbols and Other Abbreviations

(1) Where used in this Supplementary Standard, a symbol or abbreviation listed in Column 2 of Table 1.4.2.1. of Division A of the *Building Code* shall have the meaning listed opposite it in Column 3.

(2) The abbreviations listed in Column 2 of Table 1.3.2.1. shall also apply to this Supplementary Standard and shall have the meaning listed opposite it in Column 3.

Table 1.3.2.1.
Abbreviations
Forming Part of Sentence 1.3.2.1.(2)

Item	Abbreviation	Meaning
1	ACH	air changes per hour
2	AFUE	annual fuel utilization efficiency
3	ASHP	air source heat pump
4	ci	continuous insulation (See Appendix A.)
5	EF	energy factor
6	HRV	heat or energy recovery ventilator
7	HSPF	heating seasonal performance factor
8	ICF	insulating concrete form
9	IP	inch-pound - imperial
10	K	Kelvin
11	NLA	normalised leakage area
12	NLR	normalised leakage rate
13	SI	standard international – metric
14	SRE	sensible recovery efficiency
15	TPF	thermal performance factor
16	U-Value	overall thermal transmittance or overall coefficient of heat transfer
Column 1	2	3

Section 1.4. Referenced Documents and Organizations

1.4.1. Referenced Documents

1.4.1.1. Effective Date

(1) Unless otherwise specified in this Supplementary Standard, the documents referenced in this Supplementary Standard shall include all amendments, revisions and supplements effective to October 31, 2011.

1.4.1.2. Applicable Editions

(1) Where documents are referenced in this Supplementary Standard, they shall be the editions designated in Column 2 of Table 1.4.1.2.

Table 1.4.1.2.
Referenced Documents
 Forming Part of Sentence 1.4.1.2.(1)

Issuing Agency	Document Number	Title of Document	Supplementary Standard Reference
CGSB	CAN/CGSB 149.10-M86	Determination of the Airtightness of Building Envelopes by the Fan Depressurization Method	3.1.1.4.(2)
CSA	CAN/CSA-A440.2-09	Fenestration Energy Performance Evaluation of Windows and Sliding Glass Doors	2.1.1.8.(2); 3.1.1.9.(2)
CSA	B55.1-12	Test Method for Measuring Efficiency and Pressure Loss of Drain Water Heat Recovery Units	2.1.1.11.(3); 3.1.1.12.(4)
CSA	B55.2-12	Drain Water Heat Recovery Units	2.1.1.11.(2); 3.1.1.12.(3)
CSA	CAN/CSA-P.9-11	Test Method for Determining the Performance of Combined Space and Water Heating Systems (Combos)	3.1.1.2.(7); 3.1.1.3.(7)
NFRC	NFRC 100-2010	Procedure for Determining Fenestration Product U-factors	2.1.1.8.(2); 3.1.1.9.(2)
NFRC	NFRC 200-2010	Procedure for Determining Fenestration Product Solar Heat Gain Coefficient and Visible Transmittance at Normal Incidence	2.1.1.8.(2); 3.1.1.8.(2)
NRCan	NRCan January 2011	Energy Star for New Homes: Technical Specifications – Ontario	2.1.3.1.(1)
NRCan	NRCan January 2012	Energy Star for New Homes Standard Version 12.1	2.1.3.1.(1)
NRCan	NRCan January 2012	Energy Star for New Homes Standard Version 12.6	3.1.3.1.(1)
NRCan	NRCan November 2015	EnerGuide Rating System Technical Procedures Version 15.1	3.1.1.4.(2); 3.1.2.1.
e4 NRCan	NRCan 2012	2012 R-2000 Standard	2.1.3.1.(2); 3.1.3.1.(2)
Column 1	2	3	4

Notes to Table 1.4.1.2.:

(1) NFRC refers to the National Fenestration Rating Council. (See Appendix A.)

1.4.2. Abbreviations

1.4.2.1. Abbreviations of Proper Names

(1) Where used in this Supplementary Standard, abbreviations of proper names listed in Column 1 of Table 1.3.2.1. of Division B of the *Building Code* shall have the meaning assigned opposite it in Column 2.

Chapter 2

Acceptable Solutions for Energy Efficiency Compliance Before January 1, 2017

(Applies to construction for which a permit has been applied for before January 1, 2017)

Section 2.1. Methods for Achieving Energy Efficiency Compliance

2.1.1. Prescriptive Compliance Packages (See Appendix A.)

2.1.1.1. Energy Efficiency

- (1) Except as permitted in Articles 2.1.1.5. to 2.1.1.10., the minimum thermal performance and energy efficiency of *building* envelope and space heating equipment, domestic water heating equipment and heat or energy recovery ventilator equipment shall conform to
 - (a) Article 2.1.1.2. if the *building* is located in Zone 1 with less than 5000 heating degree days, or
 - (b) Article 2.1.1.3. if the *building* is located in Zone 2 with 5000 or more heating degree days.
- (2) All walls, ceilings, floors, windows and doors that separate heated space from unheated space, the exterior air or the exterior *soil* shall have thermal resistance ratings conforming to this Subsection.
- (3) Where specified in compliance packages in Tables 2.1.1.2.A, 2.1.1.2.B and 2.1.1.2.C and Tables 2.1.1.3.A, 2.1.1.3.B and 2.1.1.3.C, space heating equipment, domestic water heating equipment and heat or energy recovery ventilators shall have the efficiency rating conforming to this Subsection. (See Appendix A.)
- (4) Insulation shall be provided between heated and unheated spaces and between heated spaces and the exterior in accordance with this Chapter.
- (5) Reflective surfaces of insulating materials shall not be considered in calculating the thermal resistance of *building* assemblies.
- (6) Where glass block is used in a wall, the required minimum overall performance of the *building* envelope shall be maintained by increasing thermal performance of other components sufficient to compensate for the additional heat loss through the glass block.
- (7) Except as provided in Sentence (8) and except as permitted in Sentences (9) and 2.1.1.10.(3), where the ratio of the gross area of windows, sidelights, skylights, glazing in doors and sliding glass doors to the gross area of peripheral walls measured from grade to the top of the upper most ceiling is not more than 17%, the *building* shall comply with a compliance package selected from Tables 2.1.1.2.A, 2.1.1.2.B and 2.1.1.2.C and Tables 2.1.1.3.A, 2.1.1.3.B and 2.1.1.3.C. (See Appendix A.)

(8) Except as permitted in Sentences (9) and 2.1.1.10.(3), where the ratio of the gross area of windows, sidelights, skylights, glazing in doors and sliding glass doors to the gross area of peripheral walls measured from grade to the top of the upper most ceiling is more than 17% but not more than 22%, the *building* shall comply with a compliance package selected from Tables 2.1.1.2.A, 2.1.1.2.B and 2.1.1.2.C and Tables 2.1.1.3.A, 2.1.1.3.B and 2.1.1.3.C, and the *overall coefficient of heat transfer* of the glazing shall be upgraded to

- (a) 1.8 where the selected compliance package requires 2.0,
- (b) 1.6 where the selected compliance package requires 1.8, and
- (c) 1.4 where the selected compliance package requires 1.6.

(See Appendix A.)

(9) Glazing in main entrance doors and adjacent sidelights to main entrance doors need not be calculated for the purposes of Sentences (7), (8) and (10).

(10) Except as provided in Sentences (9) and 2.1.1.10.(3), where the ratio of gross area of windows, sidelights, skylights, glazing in doors and sliding glass doors to the gross area of peripheral walls measured from grade to the top of the upper most ceiling is more than 22%, the *building* shall comply with Subsection 2.1.2. (See Appendix A.)

(11) Where a *dwelling* unit has a walkout *basement*, the thermal performance level of the exterior *basement* wall shall be not less than that required for the above grade wall for

- (a) the *basement* wall containing the door opening, and
- (b) any *basement* wall that has an exposed wall area above the ground level exceeding 50% of that *basement* wall area.

(12) The minimum thermal resistance of insulation shall conform to the applicable values specified in Articles 2.1.1.2., 2.1.1.3. and 2.1.1.10.

(13) The minimum annual fuel utilization efficiency of a natural gas- or propane-fired furnace serving a *building* of *residential occupancy* shall conform to Table 2.1.1.1.A.

Table 2.1.1.1.A.
Furnace Minimum Annual Fuel Utilization Efficiency
Forming Part of Sentence 2.1.1.1.(13)

Furnace Fuel Source	Minimum AFUE
Natural gas	90%
Propane	90%
Column 1	2

(14) Where space heating is supplied by a solid fuel-burning *appliance* or an earth energy system, the compliance package is permitted to comply with Tables 2.1.1.2.A. and 2.1.1.3.A.

(15) Where an enclosed unheated space is separated from a heated space by glazing, the unheated enclosure may be considered to provide a thermal resistance of RSI 0.16.

(16) Where space heating equipment and domestic water heating equipment efficiencies are specified in a compliance package in Tables 2.1.1.2.A, 2.1.1.2.B and 2.1.1.2.C and Tables 2.1.1.3.A, 2.1.1.3.B and 2.1.1.3.C, the equipment efficiencies shall be determined in accordance with test procedures regulated by an applicable Ontario Regulation, or in the absence of such regulation, determined in accordance with test procedures governed by the applicable equipment standard.

(17) Where heat or energy recovery ventilators are specified in a compliance package in Tables 2.1.1.2.A, 2.1.1.2.B and 2.1.1.2.C and Tables 2.1.1.3.A, 2.1.1.3.B and 2.1.1.3.C, they shall

- (a) meet the requirements of Article 9.32.3.11. of Division B of the *Building Code*, and
- (b) meet the minimum efficiency rating required in this Chapter based on a test temperature of 0°C at an air flow rate equal to the principle exhaust flow but need not exceed 30 L/s.

2.1.1.2. Energy Efficiency for Buildings Located in Zone 1

- (1) Except as required in Sentences (2) to (4) and permitted in Sentences (5) to (11), the minimum thermal performance of *building* envelope and equipment shall conform to Table 2.1.1.2.A.
- (2) Except for solid fuel-burning space heating equipment and natural gas and propane furnaces, where the space heating equipment efficiency ranges from 78% to less than 90%, the minimum thermal performance of the *building* envelope and equipment shall conform to Table 2.1.1.2.B.
- (3) Where *electric space heating* is used, the minimum thermal performance of the *building* envelope and equipment shall conform to Table 2.1.1.2.C.
- (4) Except for solid fuel-burning space heating equipment, where the space heating equipment efficiency is less than 78% or it cannot meet the requirements of the applicable compliance packages, energy efficiency compliance shall be achieved in accordance with Clause 12.2.1.1.(3)(a) of Division B of the *Building Code* or Subsection 2.1.2. of this Supplementary Standard.
- (5) Where the thermal performance of above grade walls, windows or *basement* walls is reduced by applying Sentences (6) through (11), only the thermal performance of one of those *building* components is permitted to be reduced.
- (6) Except as permitted in Sentence (7), where compliance package I or J in Table 2.1.1.2.A is used, the minimum RSI value for thermal insulation in exposed above grade walls is permitted to be not less than RSI 3.52 provided that
 - (a) the *overall coefficient of heat transfer* of the glazing is upgraded in accordance with Sentence 2.1.1.1.(8), in addition to an upgrade where it is required due to high fenestration to wall ratio, or (See Appendix A.)
 - (b) the thermal insulation value in *basement* walls has a minimum RSI 3.52 where compliance package J is used.
- (7) Where blown-in insulation or spray-applied foam insulation is used in compliance package I or J in Table 2.1.1.2.A, the minimum RSI value for thermal insulation in exposed above grade walls is permitted to be not less than RSI 3.52 provided that
 - (a) the thermal insulation value in a ceiling with an attic space is not less than RSI 10.55,
 - (b) the minimum efficiency of the HRV is increased by not less than 8 percentage points,
 - (c) the minimum AFUE of the space heating equipment is increased by not less than 2 percentage points,
 - (d) the minimum EF of the domestic water heater is increased by not less than 4 percentage points, or
 - (e) the *building* is in compliance with Sentence (6).
- (8) Except as permitted in Sentence (9), where compliance package D, E, F, G, H or M in Table 2.1.1.2.A is used, the minimum RSI value for thermal insulation of exposed above grade walls is permitted to be not less than RSI 3.52 provided that
 - (a) the *overall coefficient of heat transfer* of the glazing is upgraded in accordance with Sentence 2.1.1.1.(8), in addition to an upgrade where it is required due to high fenestration to wall ratio, and the minimum EF of the domestic water heater is increased by not less than 8 percentage points, or (See Appendix A.)
 - (b) the thermal insulation value in *basement* walls has a minimum RSI 3.52 where compliance package F, G, or H is used, and the *building* is in compliance with at least two requirements of Clauses (7)(a) to (d).
- (9) Where blown-in insulation or spray-applied foam insulation is used in compliance package D, E, F, G, H or M in Table 2.1.1.2.A, the minimum RSI value for thermal insulation in exposed above grade walls is permitted to be not less than RSI 3.52 provided that
 - (a) the *overall coefficient of heat transfer* of the glazing is upgraded in accordance with Sentence 2.1.1.1.(8), in addition to an upgrade where it is required due to high fenestration to wall ratio or the thermal insulation value in *basement* walls has a minimum RSI 3.52 where compliance package F, G, or H is used, and (See Appendix A.)
 - (b) the *building* is in compliance with Clause (7)(a), (b), (c) or (d).

(10) Where a drain water heat recovery unit conforming to Article 2.1.1.11. is provided in addition to the requirements of a compliance package selected from Tables 2.1.1.2.A to 2.1.1.2.C.

- (a) the thermal insulation value in exposed above grade walls is permitted to be not less than RSI 3.52 where it is required to be RSI 3.87,
- (b) the thermal insulation value in exposed above grade walls is permitted to be not less than RSI 3.52 where it is required to be RSI 4.23, provided that the drain water heat recovery unit has a minimum efficiency of not less than 46%,
- (c) the thermal insulation value in *basement* walls is permitted to be not less than RSI 2.11 where it is required to be RSI 3.52,
- (d) the *overall coefficient of heat transfer* of glazing is permitted to be not greater than $1.8 \text{ W}/(\text{m}^2 \cdot \text{K})$ where it is required to be $1.6 \text{ W}/(\text{m}^2 \cdot \text{K})$, or not greater than $1.6 \text{ W}/(\text{m}^2 \cdot \text{K})$ where it is required to be $1.4 \text{ W}/(\text{m}^2 \cdot \text{K})$,
- (e) the minimum efficiency of an HRV is permitted to be not less than 55% where it is required to be 75% or less, or
- (f) the minimum efficiency of a furnace is permitted to be not less than 90% where it is required to be 94%.

(11) Where an HRV is only required for the purpose of meeting the energy efficiency requirements of a compliance package included in Table 2.1.1.2.A, the HRV may be omitted provided that a drain water heat recovery unit with a minimum efficiency of not less than 62% is installed in conformance with Article 2.1.1.11.

Table 2.1.1.2.A
ZONE 1 - Compliance Packages for Space Heating Equipment with AFUE ≥ 90%
 Forming Part of Sentence 2.1.1.2.(1)

Component	Compliance Package												
	A	B	C	D	E	F	G	H	I	J	K ⁽³⁾	L ⁽⁴⁾	M ⁽⁵⁾
Ceiling with Attic Space Minimum RSI (R)-Value ⁽¹⁾	8.81 (R50)	8.81 (R50)	8.81 (R50)	8.81 (R50)	8.81 (R50)	8.81 (R50)	8.81 (R50)	8.81 (R50)	8.81 (R50)	8.81 (R50)	8.81 (R50)	8.81 (R50)	8.81 (R50)
Ceiling Without Attic Space Minimum RSI (R)-Value ⁽¹⁾	5.46 (R31)	5.46 (R31)	5.46 (R31)	5.46 (R31)	5.46 (R31)	5.46 (R31)	5.46 (R31)	5.46 (R31)	5.46 (R31)	5.46 (R31)	5.46 (R31)	5.46 (R31)	5.46 (R31)
Exposed Floor Minimum RSI (R)-Value ⁽¹⁾	5.46 (R31)	5.46 (R31)	5.46 (R31)	5.46 (R31)	5.46 (R31)	5.46 (R31)	5.46 (R31)	5.46 (R31)	5.46 (R31)	5.46 (R31)	5.46 (R31)	5.46 (R31)	5.46 (R31)
Walls Above Grade Minimum RSI (R)-Value ⁽¹⁾	4.23 (R24)	4.75 (R27)	4.75 (R27)	4.23 (R24)	4.23 (R24)	4.23 (R24)	4.23 (R24)	4.23 (R24)	3.87 (R22)	3.87 (R22)	3.87 (R22)	4.23 (R24)	4.23 (R24)
Basement Walls Minimum RSI (R)-Value ⁽¹⁾	3.52 (R20)	3.52 (R20)	3.52 (R20)	3.52 (R20)	3.52 (R20)	2.11 (R12)	2.11 (R12)	2.11 (R12)	3.52 (R20)	2.11 (R12)	3.87 (R22)	3.87 (R22)	3.52 (R20)
Below Grade Slab Entire Surface > 600 mm Below Grade Minimum RSI (R)-Value ⁽¹⁾	0.88 (R5)	—	—	—	—	—	—	—	—	—	—	—	—
Edge of Below Grade Slab ≤ 600 mm Below Grade Minimum RSI (R)-Value ⁽¹⁾	1.76 (R10)	1.76 (R10)	1.76 (R10)	1.76 (R10)	1.76 (R10)	1.76 (R10)	1.76 (R10)	1.76 (R10)	1.76 (R10)	1.76 (R10)	1.76 (R10)	1.76 (R10)	1.76 (R10)
Heated Slab or Slab ≤ 600 mm Below Grade Minimum RSI (R)-Value ⁽¹⁾	1.76 (R10)	1.76 (R10)	1.76 (R10)	1.76 (R10)	1.76 (R10)	1.76 (R10)	1.76 (R10)	1.76 (R10)	1.76 (R10)	1.76 (R10)	1.76 (R10)	1.76 (R10)	1.76 (R10)
Windows and Sliding Glass Doors Maximum U-Value ⁽²⁾	1.6	1.6	1.8	1.8	1.8	1.8	1.8	2.0	1.8	1.8	1.8	1.8	1.8
Skylights Maximum U-Value ⁽²⁾	2.8	2.8	2.8	2.8	2.8	2.8	2.8	2.8	2.8	2.8	2.8	2.8	2.8
Space Heating Equipment Minimum AFUE	90%	90%	94%	94%	90%	94%	92%	94%	92%	94%	90%	94%	90% ⁽⁷⁾
HRV ⁽⁶⁾ Minimum Efficiency	—	—	—	—	55%	60%	60%	70%	55%	60%	—	—	—
Domestic Water Heater Minimum EF	0.57	0.57	0.62	0.67	0.57	0.57	0.62	0.67	0.62	0.67	0.57	0.57	0.80 ⁽⁷⁾
Column 1	2	3	4	5	6	7	8	9	10	11	12	13	14

Notes to Table 2.1.1.2.A:

- (1) Except for notes (3) and (4), the values listed are minimum RSI-Values for the thermal insulation component only. RSI-Values are expressed in (m²·K)/W.
- (2) U-Value is the *overall coefficient of heat transfer* for a window assembly, sliding glass door assembly or skylight assembly expressed in W/(m²·K). See exceptions and use of alternative Energy Ratings (ER) in Article 2.1.1.8.
- (3) Compliance package K applies only to a *building* with both ICF *basement* walls and ICF above grade walls. Alternatively, any other compliance package is permitted to be used for a *building* with both ICF *basement* walls and ICF above grade walls. The thermal resistance value of an ICF wall is the total thermal resistance of the entire wall assembly.
- (4) Compliance package L applies only to a *building* with ICF *basement* walls. Alternatively, any other compliance package except compliance package K, is permitted to be used for a *building* with ICF *basement* walls. The thermal resistance value of an ICF wall is the total thermal resistance of the entire wall assembly.
- (5) Applies to a *building* with combined space heating and domestic water heating system.
- (6) Except as required in Subsection 9.32.3. of Division B of the *Building Code*, an HRV is only required as a part of a compliance package where a minimum efficiency level is specified.
- (7) Only the water heating equipment shall meet the minimum AFUE or EF specified in the Table or shall be of the condensing type.

Table 2.1.1.2.B
ZONE 1 - Compliance Packages for Space Heating Equipment with AFUE \geq 78% and $<$ 90%
 Forming Part of Sentence 2.1.1.2.(2)

Component	Compliance Package					
	A	B	C	D	E	F
Ceiling with Attic Space Minimum RSI (R)-Value ⁽¹⁾	8.81 (R50)	8.81 (R50)	8.81 (R50)	8.81 (R50)	8.81 (R50)	8.81 (R50)
Ceiling Without Attic Space Minimum RSI (R)-Value ⁽¹⁾	5.46 (R31)	5.46 (R31)	5.46 (R31)	5.46 (R31)	5.46 (R31)	5.46 (R31)
Exposed Floor Minimum RSI (R)-Value ⁽¹⁾	5.46 (R31)	5.46 (R31)	5.46 (R31)	5.46 (R31)	5.46 (R31)	5.46 (R31)
Walls Above Grade Minimum RSI (R)-Value ⁽¹⁾	5.11 (R29)	5.11 (R29)	5.11 (R29)	4.75 (R27)	4.75 (R27)	4.75 (R27)
Basement Walls Minimum RSI (R)-Value ⁽¹⁾	3.52 (R20)	2.11 (R12)	3.52 (R20)	3.52 (R20)	3.52 (R20)	3.52 (R20)
Below Grade Slab Entire Surface $>$ 600 mm Below Grade Minimum RSI (R)-Value ⁽¹⁾	—	—	—	—	—	—
Edge of Below Grade Slab \leq 600 mm Below Grade Minimum RSI (R)-Value ⁽¹⁾	1.76 (R10)	1.76 (R10)	1.76 (R10)	1.76 (R10)	1.76 (R10)	1.76 (R10)
Heated Slab or Slab \leq 600 mm Below Grade Minimum RSI (R)-Value ⁽¹⁾	1.76 (R10)	1.76 (R10)	1.76 (R10)	1.76 (R10)	1.76 (R10)	1.76 (R10)
Windows and Sliding Glass Doors Maximum U-Value ⁽²⁾	1.6	1.6	1.8	1.6	1.6	1.8
Skylights Maximum U-Value ⁽²⁾	2.8	2.8	2.8	2.8	2.8	2.8
Space Heating Equipment Minimum AFUE	78%	84%	84%	84%	78%	84%
HRV Minimum Efficiency	55%	55%	70%	55%	70%	75%
Domestic Water Heater Minimum EF	—	—	—	—	—	—
Column 1	2	3	4	5	6	7

Notes to Table 2.1.1.2.B:

(1) The values listed are minimum RSI-Values for the thermal insulation component only. RSI-Values are expressed in $(m^2 \cdot K)/W$.

(2) U-Value is the *overall coefficient of heat transfer* for a window assembly, sliding glass door assembly or skylight assembly expressed in $W/(m^2 \cdot K)$. See exceptions and use of alternative Energy Ratings (ER) in Article 2.1.1.8.

Table 2.1.1.2.C
ZONE 1 - Compliance Packages for Electric Space Heating
 Forming Part of Sentence 2.1.1.2.(3)

Component	Compliance Package	
	A	B
Ceiling with Attic Space Minimum RSI (R)-Value ⁽¹⁾	8.81 (R50)	8.81 (R50)
Ceiling Without Attic Space Minimum RSI (R)-Value ⁽¹⁾	5.46 (R31)	5.46 (R31)
Exposed Floor Minimum RSI (R)-Value ⁽¹⁾	5.46 (R31)	5.46 (R31)
Walls Above Grade Minimum RSI (R)-Value ⁽¹⁾	5.11 (R29)	5.11 (R29)
Basement Walls Minimum RSI (R)-Value ⁽¹⁾	3.52 (R20)	2.11 (R12)
Below Grade Slab Entire Surface > 600 mm Below Grade Minimum RSI (R)-Value ⁽¹⁾	—	—
Edge of Below Grade Slab ≤ 600 mm Below Grade Minimum RSI (R)-Value ⁽¹⁾	1.76 (R10)	1.76 (R10)
Heated Slab or Slab ≤ 600 mm Below Grade Minimum RSI (R)-Value ⁽¹⁾	1.76 (R10)	1.76 (R10)
Windows and Sliding Glass Doors Maximum U-Value ⁽²⁾	1.6	1.6
Skylights Maximum U-Value ⁽²⁾	2.8	2.8
Space Heating Equipment Minimum AFUE	—	—
HRV Minimum Efficiency	55%	75%
Domestic Water Heater Minimum EF	—	—
Column 1	2	3

Notes to Table 2.1.1.2.C:

- (1) The values listed are minimum RSI-Values for the thermal insulation component only. RSI-Values are expressed in $(m^2 \cdot K)/W$.
- (2) U-Value is the *overall coefficient of heat transfer* for a window assembly, sliding glass door assembly or skylight assembly expressed in $W/(m^2 \cdot K)$. See exceptions and use of alternative Energy Ratings (ER) in Article 2.1.1.8.

2.1.1.3. Energy Efficiency for Buildings Located in Zone 2

- (1) Except as required in Sentences (2) to (4) and permitted in Sentences (5) to (8), the minimum thermal performance of the *building* envelope and equipment shall conform to Table 2.1.1.3.A.
- (2) Except for solid fuel-burning space heating equipment and natural gas and propane furnaces, where the space heating equipment efficiency ranges from 78% to less than 90%, the minimum thermal performance of *building* envelope and equipment shall conform to Table 2.1.1.3.B.
- (3) Where *electric space heating* is used, the minimum thermal performance of the *building* envelope and equipment shall conform to Table 2.1.1.3.C.
- (4) Except for solid fuel-burning space heating equipment, where the space heating equipment efficiency is less than 78% or it cannot meet the requirements of the applicable compliance packages, energy efficiency compliance shall be achieved in accordance with Clause 12.2.1.1.(3)(a) of Division B of the *Building Code* or Subsection 2.1.2. of this Supplementary Standard.
- (5) Where the thermal performance of above grade walls, windows or *basement* walls is reduced by applying Sentences (6) through (8), only the thermal performance of one of those *building* components is permitted to be reduced.
- (6) Except as permitted in Sentence (7), where compliance package H, I, J or M in Table 2.1.1.3.A is used, the minimum RSI value for thermal insulation of exposed above grade walls is permitted to be not less than RSI 3.52 provided that
 - (a) the *overall coefficient of heat transfer* of the glazing is upgraded in accordance with Sentence 2.1.1.1.(8), in addition to a upgrade where it is required due to high fenestration to wall ratio and the minimum EF of the domestic water heater is increased by not less than 8 percentage points, or (See Appendix A.)
 - (b) the thermal insulation value in *basement* walls has a minimum RSI 3.52 where compliance package J is used, and the *building* is in compliance with at least two requirements of Clauses 2.1.1.2.(7)(a) to (d).
- (7) Where blown-in insulation or spray-applied foam insulation is used in compliance package H, I, J or M in Table 2.1.1.3.A, the minimum RSI value for thermal insulation in exposed above grade walls is permitted to be not less than RSI 3.52 provided that
 - (a) the *overall coefficient of heat transfer* of the glazing is upgraded in accordance with Sentence 2.1.1.1.(8), in addition to a upgrade where it is required due to high fenestration to wall ratio or the thermal insulation value in *basement* walls has a minimum RSI 3.52 where compliance package J is used, and (See Appendix A.)
 - (b) the *building* is in compliance with Clause 2.1.1.2.(7)(a), (b), (c) or (d).
- (8) Where a drain water heat recovery unit conforming to Article 2.1.1.11. is provided in addition to the requirements of a compliance package selected from Tables 2.1.1.3.A to 2.1.1.3.C
 - (a) the thermal insulation value in exposed above grade walls is permitted to be not less than RSI 3.87 where it is required to be RSI 4.23 provided that the drain water heat recovery unit has a minimum efficiency of not less than 41%,
 - (b) the thermal insulation value in *basement* walls is permitted to be not less than RSI 2.11 where it is required to be RSI 3.52, provided that the drain water heat recovery unit has a minimum efficiency of not less than 46%,
 - (c) the *overall coefficient of heat transfer* of glazing is permitted to be not greater than 1.8 W/(m²•K) where it is required to be 1.6 W/(m²•K),
 - (d) the *overall coefficient of heat transfer* of glazing is permitted to be not greater than 1.6 W/(m²•K) where it is required to be 1.4 W/(m²•K), provided that the drain water heat recovery unit has a minimum efficiency of not less than 41%, or
 - (e) the minimum efficiency of an HRV is permitted to be not less than 55% where it is required to be 75% or less.

Table 2.1.1.3.A
ZONE 2 - Compliance Packages for Space Heating Equipment with AFUE ≥ 90%
 Forming Part of Sentence 2.1.1.3.(1)

Component	Compliance Package												
	A	B	C	D	E	F	G	H	I	J	K ⁽³⁾	L ⁽⁴⁾	M ⁽⁵⁾
Ceiling with Attic Space Minimum RSI (R)-Value ⁽¹⁾	8.81 (R50)	8.81 (R50)	8.81 (R50)	8.81 (R50)	8.81 (R50)	8.81 (R50)	8.81 (R50)	8.81 (R50)	8.81 (R50)	8.81 (R50)	8.81 (R50)	8.81 (R50)	8.81 (R50)
Ceiling Without Attic Space Minimum RSI (R)-Value ⁽¹⁾	5.46 (R31)	5.46 (R31)	5.46 (R31)	5.46 (R31)	5.46 (R31)	5.46 (R31)	5.46 (R31)	5.46 (R31)	5.46 (R31)	5.46 (R31)	5.46 (R31)	5.46 (R31)	5.46 (R31)
Exposed Floor Minimum RSI (R)-Value ⁽¹⁾	5.46 (R31)	5.46 (R31)	5.46 (R31)	5.46 (R31)	5.46 (R31)	5.46 (R31)	5.46 (R31)	5.46 (R31)	5.46 (R31)	5.46 (R31)	5.46 (R31)	5.46 (R31)	5.46 (R31)
Walls Above Grade Minimum RSI (R)-Value ⁽¹⁾	5.11 (R29)	5.11 (R29)	5.11 (R29)	4.75 (R27)	4.75 (R27)	4.75 (R27)	4.75 (R27)	4.23 (R24)	4.23 (R24)	4.23 (R24)	3.87 (R22)	4.23 (R24)	4.23 (R24)
Basement Walls Minimum RSI (R)-Value ⁽¹⁾	3.52 (R20)	3.52 (R20)	3.52 (R20)	3.52 (R20)	3.52 (R20)	3.52 (R20)	2.11 (R12)	3.52 (R20)	3.52 (R20)	2.11 (R12)	3.87 (R22)	3.87 (R22)	3.52 (R20)
Below Grade Slab Entire Surface > 600 mm Below Grade Minimum RSI (R)-Value ⁽¹⁾	0.88 (R5)	—	—	0.88 (R5)	—	—	—	0.88 (R5)	—	—	—	—	—
Edge of Below Grade Slab ≤ 600 mm Below Grade Minimum RSI (R)-Value ⁽¹⁾	1.76 (R10)	1.76 (R10)	1.76 (R10)	1.76 (R10)	1.76 (R10)	1.76 (R10)	1.76 (R10)	1.76 (R10)	1.76 (R10)	1.76 (R10)	1.76 (R10)	1.76 (R10)	1.76 (R10)
Heated Slab or Slab ≤ 600 mm Below Grade Minimum RSI (R)-Value ⁽¹⁾	1.76 (R10)	1.76 (R10)	1.76 (R10)	1.76 (R10)	1.76 (R10)	1.76 (R10)	1.76 (R10)	1.76 (R10)	1.76 (R10)	1.76 (R10)	1.76 (R10)	1.76 (R10)	1.76 (R10)
Windows and Sliding Glass Doors Maximum U-Value ⁽²⁾	1.6	1.6	1.8	1.6	1.6	1.8	1.8	1.6	1.6	1.6	1.8	1.8	1.8
Skylights Maximum U-Value ⁽²⁾	2.8	2.8	2.8	2.8	2.8	2.8	2.8	2.8	2.8	2.8	2.8	2.8	2.8
Space-Heating Equipment Minimum AFUE	90%	94%	92%	94%	94%	94%	94%	94%	90%	94%	94%	94%	90% ⁽⁷⁾
HRV ⁽⁶⁾ Minimum Efficiency	—	—	60%	—	—	60%	75%	—	60%	60%	—	—	55%
Domestic Water Heater Minimum EF	0.57	0.57	0.57	0.57	0.67	0.57	0.62	0.67	0.57	0.67	0.57	0.67	0.80 ⁽⁷⁾
Column 1	2	3	4	5	6	7	8	9	10	11	12	13	14

Notes to Table 2.1.1.3.A:

- (1) Except for notes (3) and (4), the values listed are minimum RSI-Values for the thermal insulation component only. RSI-Values are expressed in (m²·K)/W.
- (2) U-Value is the *overall coefficient of heat transfer* for a window assembly, sliding glass door assembly or skylight assembly expressed in W/(m²·K). See exceptions and use of alternative Energy Ratings (ER) in Article 2.1.1.8.
- (3) Compliance package K applies only to a *building* with both ICF *basement* walls and ICF above grade walls. Alternatively, any other compliance package is permitted to be used for a *building* with both ICF *basement* walls and ICF above grade walls. The thermal resistance value of an ICF wall is the total thermal resistance of the entire wall assembly.
- (4) Compliance package L applies only to a *building* with ICF *basement* walls. Alternatively, any other compliance package except compliance package K, is permitted to be used for a *building* with ICF *basement* walls. The thermal resistance value of an ICF wall is the total thermal resistance of the entire wall assembly.
- (5) Applies to a *building* with combined space heating and domestic water heating system.
- (6) Except as required in Subsection 9.32.3. of Division B of the *Building Code*, an HRV is only required as a part of a compliance package where a minimum efficiency level is specified.
- (7) Only the water heating equipment shall meet the minimum AFUE or EF specified in the Table or shall be of the condensing type.

Table 2.1.1.3.B
ZONE 2 - Compliance Packages for Space Heating Equipment with AFUE \geq 78% and $<$ 90%
 Forming Part of Sentence 2.1.1.3.(2)

Component	Compliance Package	
	A	B
Ceiling with Attic Space Minimum RSI (R)-Value ⁽¹⁾	8.81 (R50)	8.81 (R50)
Ceiling Without Attic Space Minimum RSI (R)-Value ⁽¹⁾	5.46 (R31)	5.46 (R31)
Exposed Floor Minimum RSI (R)-Value ⁽¹⁾	5.46 (R31)	5.46 (R31)
Walls Above Grade Minimum RSI (R)-Value ⁽¹⁾	5.11 (R29)	5.11 (R29)
Basement Walls Minimum RSI (R)-Value ⁽¹⁾	3.52 (R20)	3.52 (R20)
Below Grade Slab Entire Surface $>$ 600 mm Below Grade Minimum RSI (R)-Value ⁽¹⁾	0.88 (R5)	0.88 (R5)
Edge of Below Grade Slab \leq 600 mm Below Grade Minimum RSI (R)-Value ⁽¹⁾	1.76 (R10)	1.76 (R10)
Heated Slab or Slab \leq 600 mm Below Grade Minimum RSI (R)-Value ⁽¹⁾	1.76 (R10)	1.76 (R10)
Windows and Sliding Glass Doors Maximum U-Value ⁽²⁾	1.6	1.6
Skylights Maximum U-Value ⁽²⁾	2.8	2.8
Space Heating Equipment Minimum AFUE	78%	84%
HRV Minimum Efficiency	75%	60%
Domestic Water Heater Minimum EF	—	—
Column 1	2	3

Notes to Table 2.1.1.3.B:

- (1) The values listed are minimum RSI-Values for the thermal insulation component only. RSI-Values are expressed in $(m^2 \cdot K)/W$.
- (2) U-Value is the *overall coefficient of heat transfer* for a window assembly, sliding glass door assembly or skylight assembly expressed in $W/(m^2 \cdot K)$. See exceptions and use of alternative Energy Ratings (ER) in Article 2.1.1.8.

Table 2.1.1.3.C
ZONE 2 - Compliance Packages for Electric Space Heating
 Forming Part of Sentence 2.1.1.3.(3)

Component	Compliance Package A
Ceiling with Attic Space Minimum RSI (R)-Value ⁽¹⁾	8.81 (R50)
Ceiling Without Attic Space Minimum RSI (R)-Value ⁽¹⁾	5.46 (R31)
Exposed Floor Minimum RSI (R)-Value ⁽¹⁾	5.46 (R31)
Walls Above Grade Minimum RSI (R)-Value ⁽¹⁾	5.11 (R29)
<i>Basement</i> Walls Minimum RSI (R)-Value ⁽¹⁾	3.52 (R20)
Below Grade Slab Entire Surface > 600 mm Below Grade Minimum RSI (R)-Value ⁽¹⁾	0.88 (R5)
Edge of Below Grade Slab ≤ 600 mm Below Grade Minimum RSI (R)-Value ⁽¹⁾	1.76 (R10)
Heated Slab or Slab ≤ 600 mm Below Grade Minimum RSI (R)-Value ⁽¹⁾	1.76 (R10)
Windows and Sliding Glass Doors Maximum U-Value ⁽²⁾	1.6
Skylights Maximum U-Value ⁽²⁾	2.8
Space Heating Equipment Minimum AFUE	—
HRV Minimum Efficiency	75%
Domestic Water Heater Minimum EF	—
Column 1	2

Notes to Table 2.1.1.3.C:

- (1) The values listed are minimum RSI-Values for the thermal insulation component only. RSI-Values are expressed in $(m^2 \cdot K)/W$.
- (2) U-Value is the *overall coefficient of heat transfer* for a window assembly, sliding glass door assembly or skylight assembly expressed in $W/(m^2 \cdot K)$. See exceptions and use of alternative Energy Ratings (ER) in Article 2.1.1.8.

2.1.1.4. Elements Acting as a Thermal Bridge

- (1) Except for a *foundation* wall, the insulated portion of a wall that incorporates wood stud framing elements that have a thermal resistance of less than RSI 0.90 shall be insulated to restrict heat flow through the studs by a material providing a thermal resistance at least equal to 25% of the thermal resistance required for the insulated portion of the assembly in Articles 2.1.1.2., 2.1.1.3. and 2.1.1.10.
- (2) Except as provided in Sentence (3), the thermal resistance of the insulated portion of a *building* assembly in Articles 2.1.1.2. and 2.1.1.3. that incorporates metal framing elements, such as steel studs and steel joists, that act as thermal bridges to facilitate heat flow through the assembly, shall be 20% greater than the values shown in Tables 2.1.1.2.A, 2.1.1.2.B and 2.1.1.2.C and Tables 2.1.1.3.A, 2.1.1.3.B and 2.1.1.3.C and Table 2.1.1.10., unless it can be shown that the heat flow is not greater than the heat flow through a wood frame assembly of the same thickness.
- (3) Sentence (2) does not apply to *building* assemblies incorporating thermal bridges where the thermal bridges are insulated to restrict heat flow through the thermal bridges by a material providing a thermal resistance at least equal to 25% of the thermal resistance required for the insulated portion of the assembly in Articles 2.1.1.2., 2.1.1.3. and 2.1.1.10.

2.1.1.5. Log Wall Construction and Post, Beam and Plank Construction

- (1) Except as provided in Sentences (2) and (3), log wall construction and post, beam and plank construction shall have a minimum thermal resistance of RSI 2.1 for the total assembly.
- (2) The thermal resistance value in Sentence (1) for the total wall assembly may be reduced to not less than RSI 1.61 if,
 - (a) the thermal resistance of insulation for the exposed roof or ceiling required in Table 2.1.1.2.A. is increased by an amount equivalent to the reduction permitted in this Sentence, and
 - (b) for log walls, the logs have tongue-and-groove or splined joints.
- (3) Where milled log walls are installed, the thermal resistance value in Sentence (1) for the total wall assembly does not apply if,
 - (a) the mean thickness of each log is not less than 150 mm,
 - (b) the thermal resistance of insulation for the exposed roof or ceiling required in Table 2.1.1.2.A is increased by RSI 0.53, and
 - (c) the logs have tongue-and-groove or splined joints.
- (4) Where a log wall is constructed in accordance with Sentences (1) to (3), the log wall shall be deemed to comply with the requirements in Subsection 9.25.3. of Division B of the *Building Code*.

2.1.1.6. Insulation of Foundation Walls

- (1) *Foundation* walls enclosing heated space shall be insulated from the underside of the subfloor to not more than 200 mm above the finished floor level of the *basement*. (See Appendix A.)
- (2) The insulation required by Sentence (1) may be provided by a system installed,
 - (a) on the interior of the *foundation* wall,
 - (b) on the exterior face of the *foundation* wall, or
 - (c) partially on the interior and partially on the exterior, provided the thermal performance of the system is equivalent to that permitted in Clauses (a) or (b).
- (3) If a *foundation* wall is constructed of hollow masonry units, one or more of the following shall be used to control convection currents in the core spaces,
 - (a) filling the core spaces,
 - (b) at least one row of semi-solid blocks at or below *grade*, or
 - (c) other similar methods.

- (4) Masonry walls of hollow units that penetrate the ceiling shall be sealed at or near the ceiling adjacent to the roof space to prevent air within the voids from entering the *attic or roof space* by,
- capping with masonry units without voids, or
 - installation of flashing material extending across the full width of the masonry.
- (5) Except as provided in Sentences (6) and (7), where a portion of a *basement* slab or a portion of a *basement* slab edge is the only part of the slab that is at the exterior ground level such as a walk-out *basement*, or within 600 mm of the exterior ground level, those portions shall have perimeter insulation extend not less than 600 mm below the slab level. (See Appendix A.)
- (6) Where the entire concrete slab is within 600 mm of the exterior ground level, the entire surface of the slab shall be insulated. (See Appendix A.)
- (7) Where a slab contains heating ducts, pipes, tubes or cables, the entire heated surface of the slab that is in contact with the ground shall be insulated.

2.1.1.7. Thermal Resistance Values for Roof Access Hatches and Eaves

- (1) The thermal resistance values for insulation required by Articles 2.1.1.2., 2.1.1.3. and 2.1.1.10. for exposed ceilings with attic spaces are permitted to be reduced
- directly above access hatches, and
 - near eaves to the extent made necessary by the roof slope and required ventilation clearances,
- except that the thermal insulation value at the location directly above access hatches and inner surfaces of exterior walls shall be not less than RSI 3.52.

2.1.1.8. Thermal Performance of Windows, Skylights and Sliding Glass Doors

- (1) Except as provided in Sentence (3) and except for sidelights to main entrance doors, windows, skylights and sliding glass doors shall meet
- the required *overall coefficient of heat transfer* in Tables 2.1.1.2.A, 2.1.1.2.B and 2.1.1.2.C and Tables 2.1.1.3.A, 2.1.1.3.B and 2.1.1.3.C and Table 2.1.1.10., or
 - the corresponding energy rating in Table 2.1.1.8.

Table 2.1.1.8.
Maximum U-Values and Minimum Energy Ratings (ER) for Windows, Skylights and Sliding Glass Doors
Forming Part of Sentence 2.1.1.8.(1)

Component	Maximum U-Values	Minimum Energy Ratings, (ER)
	U-Value, W/(m ² ·K) (Btu/h·ft ² ·°F)	ER
Skylights	2.8 (0.50)	—
Windows and Sliding Glass Doors	2.0 (0.35)	17
	1.8 (0.32)	21
	1.6 (0.28)	25
	1.4 (0.25)	29
Column 1	2	3

- (2) The energy rating and the *overall coefficient of heat transfer* required for windows and sliding glass doors in a *residential occupancy* shall be determined in conformance with
 - (a) CAN/CSA-A440.2, “Fenestration Energy Performance”, or
 - (b) NFRC 100, “Procedure for Determining Fenestration Product U-factors” and NFRC 200, “Procedure for Determining Fenestration Product Solar Heat Gain Coefficient and Visible Transmittance at Normal Incidence”.
- (3) A *basement* window that incorporates a *loadbearing* structural frame shall be double glazed with a low-E coating.

2.1.1.9. Minimum Thermal Resistance of Doors

- (1) Except for doors in enclosed unheated vestibules and cold cellars, and except for glazed portions of doors, all doors that separate heated space from unheated space shall have a thermal resistance of not less than RSI 0.7 where a storm door is not provided.

2.1.1.10. Additions to Existing Buildings

- (1) Except as provided in Sentences (2) and (3), an addition to an existing *building* shall be designed to this Subsection and comply with the applicable requirements of

- (a) the Tables referenced in Article 2.1.1.2. or 2.1.1.3. , or
- (b) Table 2.1.1.10. in lieu of the Tables referenced in Sentences 2.1.1.1.(7) and (8).

(See Appendix A.)

- (2) For the purpose of Sentences 2.1.1.1.(7) to (10) and Subsection 2.1.2., the addition may be considered independently or in combination with the existing *building*, regardless of the thermal characteristics of the existing *building* envelope.

(See Appendix A.)

- (3) A *one-storey* sunroom addition to an existing *building* shall be deemed to be in compliance with Articles 2.1.1.2. and 2.1.1.3. and Subsection 2.1.2., provided that the *overall coefficient of heat transfer* of

- (a) doors, windows and walls has a maximum U-Value of
 - (i) 1.6 if the *building* is located in Zone 1 with less than 5000 heating degree days,
 - (ii) 1.4 if the *building* is located in Zone 2 with 5000 or more heating degree days, or
 - (iii) 1.4 if the *building* uses *electric space heating*, and

- (b) roofs and skylights has a maximum U-Value of 2.6.

(See Appendix A.)

Table 2.1.1.10.
Thermal Performance Requirements for Additions to Existing Buildings⁽³⁾
Forming Part of Sentence 2.1.1.10.(2)

Component	Zone 1 Less than 5000 Degree-Days	Zone 2 5000 or more Degree-Days	<i>Electric Space Heating</i> Zones 1 and 2
Ceiling with Attic Space Minimum RSI (R)-Value ⁽¹⁾	8.81 (R50)	8.81 (R50)	8.81 (R50)
Ceiling Without Attic Space Minimum RSI (R)-Value ⁽¹⁾	5.46 (R31)	5.46 (R31)	5.46 (R31)
Exposed Floor Minimum RSI (R)-Value ⁽¹⁾	5.46 (R31)	5.46 (R31)	5.46 (R31)
Walls Above Grade Minimum RSI (R)-Value ⁽¹⁾	4.23 (R24)	4.23 (R24)	5.46 (R31)
Basement Walls Minimum RSI (R)-Value ⁽¹⁾	3.52 (R20)	3.52 (R20)	3.52 (R20)
Edge of Below Grade Slab \leq 600 mm Below Grade Minimum RSI (R)-Value ⁽¹⁾	1.76 (R10)	1.76 (R10)	1.76 (R10)
Heated Slab or Slab \leq 600 mm Below Grade Minimum RSI (R)-Value ⁽¹⁾	1.76 (R10)	1.76 (R10)	1.76 (R10)
Windows and Sliding Glass Doors Maximum U-Value ⁽²⁾	1.8	1.6	1.6
Skylights Maximum U-Value ⁽²⁾	2.8	2.8	2.8
Column 1	2	3	4

Notes to Table 2.1.1.10.:

- (1) The values listed are minimum RSI-Values for the thermal insulation component only. RSI-Values are expressed in $(m^2 \cdot K)/W$.
- (2) U-Value is the *overall coefficient of heat transfer* for a window assembly, sliding glass door assembly or skylight assembly expressed in $W/(m^2 \cdot K)$. See exceptions and use of alternative Energy Ratings (ER) in Article 2.1.1.8.
- (3) The *building* need not conform to minimum efficiency requirements for HRV's, domestic water heaters and space heating equipment required in Article 2.1.1.2. or 2.1.1.3.

2.1.1.11. Drain Water Heat Recovery

- (1) Where a drain water heat recovery unit is installed to meet the requirements of this Subsection, the unit and its installation shall conform to Sentences (2) to (5).
- (2) Drain water heat recovery units shall conform to CSA B55.2, “Drain Water Heat Recovery Units”.
- (3) The minimum efficiency of a drain water heat recovery unit shall be determined in conformance with CSA B55.1, “Test Method for Measuring Efficiency and Pressure Loss of Drain Water Heat Recovery Units”.
- (4) A drain water heat recovery unit shall be installed
 - (a) to receive drain water from all showers or at least two showers where there are two or more showers in a *dwelling unit*, (See Appendix A.)
 - (b) in an upright position that does not diverge more than 5 degrees from the vertical,
 - (c) in a position such that the cold water inlet connection is at the bottom of the unit,
 - (d) downstream of a water softener where a water softener is installed, and
 - (e) in a *conditioned space* or on the warm side of the dewpoint of the wall assembly.
- (5) Except as required in Clauses 2.1.1.2.(10)(b) and 2.1.1.3.(8)(a), (b) and (d), and Sentence 2.1.1.2.(11), the minimum efficiency of the drain water heat recovery unit shall be not less than 36% when it is tested in accordance with Sentence (3).

2.1.2. Performance Compliance

2.1.2.1. Required Performance Level (See Appendix A.)

- (1) The performance level shall be measured based on the simulated annual energy use of the *building*.
- (2) The simulated annual energy use of the proposed *building* shall not be greater than the simulated annual energy use of the *building* as if it met the performance level of a permitted compliance package in Subsection 2.1.1. selected on the basis of
 - (a) zone location,
 - (b) energy source, and
 - (c) equipment efficiency.
- (3) The simulated annual energy use shall be calculated for the
 - (a) proposed *building*, and
 - (b) *building* conforming to the applicable compliance package.
- (4) For the purpose of calculations required in Sentence (3),
 - (a) a recognized annual energy use simulation software shall be used to calculate annual energy use,
 - (b) local climatic data shall be used, and
 - (c) the equivalent domestic water, appliance and other plug-in loads shall be assumed in both calculations.
- (5) Except as provided in Sentence (6), for the purpose of Clauses (3)(a) and (3)(b), the air leakage rate of a *dwelling unit* may be assumed to be
 - (a) 2.5 air changes per hour at an air pressure differential of 50 Pa for detached homes, and
 - (b) 3.0 air changes per hour at an air pressure differential of 50 Pa for attached homes.
- (6) For the purpose of Clause (3)(a), values less than Sentence (5) may be used provided that the values are verified with air leakage tests as conducted in accordance with the requirements of Clause 12.2.1.(3)(a) of Division B of the *Building Code*.
- (7) For the purpose of calculations required in Clause (3)(b), the *building* shall have identical dimensions and orientation as the proposed design, except where the glazing to wall ratio exceeds 22%, the glazing area shall be reduced proportionally along each exposure until the limit is met.

(8) For the purpose of calculations required in Clause (3)(b), where frame construction is used, the design of the framing system shall assume a spacing of

- (a) 406 mm o.c. for wall studs,
- (b) 406 mm o.c. for exposed floors joists, roof joists and roof rafters, and
- (c) 610 mm o.c. for roof trusses.

(9) For the purpose of calculations required in Clause (3)(b), *building* envelope component properties and characteristics not specifically described in this Subsection and Subsection 2.1.1. shall be modeled the same for both the proposed design and a design based on a permitted compliance package unless it can be shown such properties and characteristics of the proposed design constitute additional energy conservation measures.

(10) Where the overall thermal performance of the proposed *building* envelope is less than the envelope performance of the compliance package that is compared against it, the reduction in the performance level of the *building* envelope shall not be more than 25%.

2.1.3. Other Acceptable Compliance Methods

2.1.3.1. Other Acceptable Compliance Methods (See Appendix A.)

(1) A building shall be deemed to be in compliance with the requirements of Subsection 2.1.1. provided that the building is in compliance with the technical requirements of

- (a) NRCan, “Energy Star for New Homes Standard Version 12.1”, or
- (b) NRCan, “2012 R-2000 Standard”.

Chapter 3

Acceptable Solutions for Energy Efficiency Compliance After December 31, 2016

(Applies to construction for which a permit has been applied for after December 31, 2016)

Section 3.1. Methods for Achieving Energy Efficiency Compliance

3.1.1. Prescriptive Compliance Packages (See Appendix A.)

3.1.1.1. Energy Efficiency

- (1) Except as provided in Articles 3.1.1.4. to 3.1.1.11., the *building* shall conform to
 - (a) Article 3.1.1.2. if the *building* is located in Zone 1 with less than 5000 heating degree days, or
 - (b) Article 3.1.1.3. if the *building* is located in Zone 2 with 5000 or more heating degree days.
- (2) Except as required in Sentence (5), all walls, ceilings, floors, windows and doors that separate heated space from unheated space, the exterior air or the exterior *soil* shall have thermal resistance ratings conforming to this Subsection.
- (3) Where specified in compliance packages in Tables 3.1.1.2.A to 3.1.1.2.C and Tables 3.1.1.3.A to 3.1.1.3.C, space heating equipment, domestic water heating equipment and heat or energy recovery ventilators shall be provided and have the efficiency rating conforming to this Subsection. (See Appendix A.)
- (4) Except as required in Sentence (5), insulation shall be provided between heated and unheated spaces and between heated spaces and the exterior in accordance with this Chapter.
- (5) A *building* envelope assembly that separates a *conditioned space* from an adjoining *storage garage* shall be treated as an assembly separating heated space from exterior, even if the *storage garage* is intended to be heated.
- (6) Reflective surfaces of insulating materials shall not be considered in calculating the thermal resistance of *building* assemblies.
- (7) Except as provided in Sentences (8) and 3.1.1.11.(3), where the ratio of the gross area of windows, sidelights, skylights, glazing in doors and sliding glass doors to the gross area of peripheral walls measured from grade to the top of the upper most ceiling is not more than 17%, the *building* shall comply with a compliance package selected from Tables 3.1.1.2.A to 3.1.1.2.C and Tables 3.1.1.3.A to 3.1.1.3.C, and Table 3.1.1.11. (See Appendix A.)

- (8) Except as permitted in Sentences 3.1.1.11.(3), where the ratio of the gross area of windows, sidelights, skylights, glazing in doors and sliding glass doors to the gross area of peripheral walls measured from grade to the top of the upper most ceiling is more than 17% but not more than 22%, the *building* shall comply with a compliance package selected from Tables 3.1.1.2.A to 3.1.1.2.C, Tables 3.1.1.3.A to 3.1.1.3.C and Table 3.1.1.11 and the *overall coefficient of heat transfer* of the *fenestration* shall be upgraded to
- (a) 1.6 where 1.8 is required by the selected compliance package or permitted by Article 3.1.1.4.,
 - (b) 1.4 where 1.6 is required by the selected compliance package or permitted by Article 3.1.1.4.,
 - (c) 1.2 where 1.4 is required by the selected compliance package or permitted by Article 3.1.1.4., and
 - (d) 1.0 where 1.2 is required by the selected compliance package or permitted by Article 3.1.1.4..
- (See Appendix A.)
- (9) Where the ratio of gross area of windows, sidelights, skylights, glazing in doors and sliding glass doors to the gross area of peripheral walls measured from grade to the top of the upper most ceiling is more than 22%, the *building* shall comply with Subsection 3.1.2. (See Appendix A.)
- (10) Where a *dwelling unit* has a walkout *basement*, the thermal performance level of the exterior *basement* wall shall be not less than that required for the above grade wall for
- (a) the *basement* wall containing the door opening, and
 - (b) any *basement* wall that has an exposed wall area above the ground level exceeding 50% of that *basement* wall area.
- (11) For a *conditioned space*, the exterior *building* envelope or envelope that separates *conditioned space* from unconditioned space shall conform to the applicable values specified in Articles 3.1.1.2. and 3.1.1.3.
- (12) Where an enclosed unheated space is separated from a heated space by glazing, the unheated enclosure may be considered to provide a thermal resistance of RSI 0.16.
- (13) Where a compliance package in Tables 3.1.1.2.A to 3.1.1.2.C, Tables 3.1.1.3.A to 3.1.1.3.C, or Table 3.1.1.11 specifies a nominal RSI value, *effective RSI value* and U-Value for a component specified in Column 1 of the Table and the component conforms to one of the thermal values, the component need not conform to the other thermal values specified for the component.
- (14) Insulation in the rim joist or header area where the floor assembly and wall assembly intersect shall have a thermal value not less than the thermal value of the insulation in the walls above grade.
- (15) Where a compliance package in Tables 3.1.1.2.A to 3.1.1.2.C, Tables 3.1.1.3.A to 3.1.1.3.C, or Table 3.1.1.11 specifies an *overall coefficient of heat transfer* and an energy rating value for a *fenestration* component specified in Column 1 of the Table and the component conforms to one of the thermal values, the component need not conform to the other thermal value specified for the component.
- (16) Ventilation systems serving *dwelling units* shall have a heat or energy recovery ventilator. (See Appendix A)
- (17) Except as provided in Sentence (18), a *building* is permitted to be designed in conformance with any of the compliance packages available for the climate zone that the *building* is located in, if the primary space heating of the *building* is supplied by
- (a) a wood burning *appliance*,
 - (b) an earth energy system, or
 - (c) an air or water source heat pump that does not use electric resistance as a back-up heat source.
- (18) For the purpose of Sentence (17), the requirements in the compliance packages for space heating equipment do not apply.
- (19) Heat or energy recovery ventilators specified in compliance packages in Tables 3.1.1.2.A to 3.1.1.2.C and Tables 3.1.1.3.A to 3.1.1.3.C, shall meet
- (a) the requirements of Article 9.32.3.11. of Division B of the *Building Code*, and
 - (b) the minimum SRE required in this Chapter based on a test temperature of 0°C at an air flow rate equal to the principle exhaust flow but need not exceed 30 L/s.

(20) *Building* envelope components that enclose a *common space* and are exposed to exterior or unconditioned space shall conform to this Subsection.

(21) Heating, ventilating, *air-conditioning* and lighting systems serving *common spaces* need not comply with this Subsection but shall comply with the other parts of the *Building Code*.

(22) Drain water heat recovery units shall be installed in accordance with Article 3.1.1.12.

3.1.1.2. Energy Efficiency for Buildings Located in Zone 1

(1) Except as provided in Sentences (2) to (5) and (7), the minimum thermal performance of *building* envelope assemblies and equipment shall conform to Table 3.1.1.2.A.

(2) Except for solid fuel-burning space heating equipment and except as provided in Sentence (5), where the space heating equipment efficiency is 84% or more but less than 92%, the minimum thermal performance of the *building* envelope assemblies and equipment shall conform to Table 3.1.1.2.B.

(3) Where *electric space heating* is used, the minimum thermal performance of the *building* envelope assemblies and equipment shall conform to Table 3.1.1.2.C.

(4) Except as provided in Sentence 3.1.1.1.(17), where the space heating equipment efficiency cannot meet the requirements of the applicable compliance packages, energy efficiency compliance shall be achieved in accordance with Subsection 3.1.2. of this Supplementary Standard.

(5) Where an ICF wall assembly is installed as an above and below grade wall assembly that has minimum RSI 1.76 (R10) insulation on the interior surface of the concrete and minimum RSI 1.76 (R10) insulation on the exterior surface, the ICF wall is deemed to comply with the thermal values set out for walls in the compliance packages in Table 3.1.1.2.A. (See Appendix A.)

(6) An ICF wall assembly described in Sentence (5) is permitted to be used in lieu of *basement* walls that require insulation value of RSI 3.52 ci (R20) or less. (See Appendix A.)

(7) *Building* designs that utilize combined space heating and domestic water heating systems are permitted to use compliance package A4, provided that

- (a) the water heating equipment has a minimum of 0.80 EF, 90% AFUE, or is a condensing type, or
- (b) the combination of equipment has a minimum of 0.85 TPF determined in accordance with CAN/CSA-P.9, "Test Method for Determining the Performance of Combined Space and Water Heating Systems (Combos)".

Table 3.1.1.2.A (SI)
 ZONE 1 - Compliance Packages for Space Heating Equipment with AFUE \geq 92%
 Forming Part of Sentence 3.1.1.2.(1)

Component	Thermal Values ⁽⁸⁾	Compliance Package					
		A1	A2	A3	A4	A5	A6
Ceiling with Attic Space	Min. Nominal RSI ⁽¹⁾	10.56	10.56	8.80	10.56	8.80	10.56
	Max. U ⁽²⁾	0.096	0.096	0.115	0.096	0.115	0.096
	Min. Effective RSI ⁽²⁾	10.43	10.43	8.67	10.43	8.67	10.43
Ceiling Without Attic Space	Min. Nominal RSI ⁽¹⁾	5.46	5.46	5.46	5.46	5.46	5.46
	Max. U ⁽²⁾	0.205	0.205	0.205	0.205	0.205	0.205
	Min. Effective RSI ⁽²⁾	4.87	4.87	4.87	4.87	4.87	4.87
Exposed Floor	Min. Nominal RSI ⁽¹⁾	5.46	5.46	6.16	5.46	6.16	5.46
	Max. U ⁽³⁾	0.190	0.190	0.177	0.190	0.177	0.190
	Min. Effective RSI ⁽³⁾	5.25	5.25	5.64	5.25	5.64	5.25
Walls Above Grade	Min. Nominal RSI ⁽¹⁾	3.87	3.34 + 0.88 ci	2.46 + 1.32 ci	3.87 + 0.88 ci	3.34 + 0.88 ci	3.87 + 0.88 ci
	Max. U ⁽³⁾	0.333	0.280	0.305	0.265	0.280	0.265
	Min. Effective RSI ⁽³⁾	3.00	3.58	3.28	3.77	3.58	3.77
Basement Walls ⁽⁴⁾	Min. Nominal RSI ⁽¹⁾	3.52 ci	2.11 + 1.76 ci	3.52 ci	3.52 ci	2.11 + 0.88 ci	3.52 ci
	Max. U ⁽⁴⁾	0.269	0.272	0.269	0.269	0.355	0.269
	Min. Effective RSI ⁽⁴⁾	3.72	3.67	3.72	3.72	2.81	3.72
Below Grade Slab Entire Surface > 600 mm Below Grade	Min. Nominal RSI ⁽¹⁾	—	—	—	—	—	—
	Max. U ⁽⁴⁾	—	—	—	—	—	—
	Min. Effective RSI ⁽⁴⁾	—	—	—	—	—	—
Heated Slab or Slab \leq 600 mm Below Grade	Min. Nominal RSI ⁽¹⁾	1.76	1.76	1.76	1.76	1.76	1.76
	Max. U ⁽⁴⁾	0.510	0.510	0.510	0.510	0.510	0.510
	Min. Effective RSI ⁽⁴⁾	1.96	1.96	1.96	1.96	1.96	1.96
Edge of Below Grade Slab \leq 600 mm Below Grade	Min. Nominal RSI ⁽¹⁾	1.76	1.76	1.76	1.76	1.76	1.76
Windows and Sliding Glass Doors	Max. U ⁽⁵⁾	1.6	1.6	1.4	1.6	1.6	1.6
	Energy Rating	25	25	29	25	25	25
Skylights	Max. U ⁽⁵⁾	2.8	2.8	2.8	2.8	2.8	2.8
Space Heating Equipment	Min. AFUE	96%	96%	94%	96%	94%	92%
HRV	Min. SRE	75%	75%	81%	75%	70%	65%
Domestic Water Heater ⁽⁷⁾	Min. EF	0.80	0.70	0.67	0.67	0.80	0.80
Column 1	2	3	4	5	6	7	8

Notes to Table 3.1.1.2.A (SI):

- (1) The values listed are minimum Nominal RSI-Values for the thermal insulation component only.
- (2) U-Value and *effective RSI value* shall include entire ceiling assembly components, from interior air film to vented space air film above insulation.
- (3) U-Value and *effective RSI value* shall include entire exposed floor or above grade wall assembly components, from interior air film to exterior air film.
- (4) U-Value and *effective RSI value* shall include entire basement wall or slab assembly components and interior air film.
- (5) U-Value is the *overall coefficient of heat transfer* for a window assembly, sliding glass door assembly or skylight assembly expressed in W/(m²·K).
- (6) In the case of *basement* wall assemblies, where RSI 3.52 ci is required RSI 2.11 + 1.76 ci is permitted to be used or vice versa; or where RSI 2.11 + 0.88 ci is required, RSI 2.64 ci is permitted to be used or vice versa.
- (7) If an EF of a water tank is not indicated in a compliance package, there is no EF requirement for water tank for that specific compliance package.
- (8) Nominal and *effective RSI values* are expressed in (m²·K)/W. U-Values are expressed in W/(m²·K).

Table 3.1.1.2.A (IP)
ZONE 1 - Compliance Packages for Space Heating Equipment with AFUE ≥ 92%
 Forming Part of Sentence 3.1.1.2.(1)

Component	Thermal Values ⁽⁶⁾	Compliance Package					
		A1	A2	A3	A4	A5	A6
Ceiling with Attic Space	Min. Nominal R ⁽¹⁾	60	60	50	60	50	60
	Max. U ⁽²⁾	0.017	0.017	0.020	0.017	0.020	0.017
	Min. Effective R ⁽²⁾	59.22	59.22	49.23	59.22	49.23	59.22
Ceiling Without Attic Space	Min. Nominal R ⁽¹⁾	31	31	31	31	31	31
	Max. U ⁽²⁾	0.036	0.036	0.036	0.036	0.036	0.036
	Min. Effective R ⁽²⁾	27.65	27.65	27.65	27.65	27.65	27.65
Exposed Floor	Min. Nominal R ⁽¹⁾	31	31	35	31	35	31
	Max. U ⁽³⁾	0.034	0.034	0.031	0.034	0.031	0.034
	Min. Effective R ⁽³⁾	29.80	29.80	32.02	29.80	32.02	29.80
Walls Above Grade	Min. Nominal R ⁽¹⁾	22	19 + 5 ci	14 + 7.5 ci	22 + 5 ci	19 + 5 ci	22 + 5 ci
	Max. U ⁽³⁾	0.059	0.049	0.054	0.047	0.049	0.047
	Min. Effective R ⁽³⁾	17.03	20.32	18.62	21.40	20.32	21.40
<i>Basement</i> Walls ⁽⁶⁾	Min. Nominal R ⁽¹⁾	20 ci	12 + 10 ci	20 ci	20 ci	12 + 5 ci	20 ci
	Max. U ⁽⁴⁾	0.047	0.048	0.047	0.047	0.063	0.047
	Min. Effective R ⁽⁴⁾	21.12	20.84	21.12	21.12	15.96	21.12
Below Grade Slab Entire Surface > 600 mm Below Grade	Min. Nominal R ⁽¹⁾	—	—	—	—	—	—
	Max. U ⁽⁴⁾	—	—	—	—	—	—
	Min. Effective R ⁽⁴⁾	—	—	—	—	—	—
Heated Slab or Slab ≤ 600 mm Below Grade	Min. Nominal R ⁽¹⁾	10	10	10	10	10	10
	Max. U ⁽⁴⁾	0.090	0.090	0.090	0.090	0.090	0.090
	Min. Effective R ⁽⁴⁾	11.13	11.13	11.13	11.13	11.13	11.13
Edge of Below Grade Slab ≤ 600 mm Below Grade	Min. Nominal R ⁽¹⁾	10	10	10	10	10	10
Windows and Sliding Glass Doors	Max. U ⁽⁵⁾	0.28	0.28	0.25	0.28	0.28	0.28
	Energy Rating	25	25	29	25	25	25
Skylights	Max. U ⁽⁵⁾	0.49	0.49	0.49	0.49	0.49	0.49
Space Heating Equipment	Min. AFUE	96%	96%	94%	96%	94%	92%
HRV	Min. SRE	75%	75%	81%	75%	70%	65%
Domestic Water Heater ⁽⁷⁾	Min. EF	0.80	0.70	0.67	0.67	0.80	0.80
Column 1	2	3	4	5	6	7	8

Notes to Table 3.1.1.2.A (IP):

- (1) The values listed are minimum Nominal R-Values for the thermal insulation component only.
- (2) U-Value and effective R value shall include entire ceiling assembly components, from interior air film to vented space air film above insulation.
- (3) U-Value and effective R value shall include entire exposed floor or above grade wall assembly components, from interior air film to exterior air film.
- (4) U-Value and effective R value shall include entire basement wall or slab assembly components and interior air film.
- (5) U-Value is the *overall coefficient of heat transfer* for a window assembly, sliding glass door assembly or skylight assembly expressed in Btu/(h·ft²·F).
- (6) In the case of *basement* wall assemblies, where R20 ci is required R12 + 10 ci is permitted to be used or vice versa; or where R12 + 5 ci is required, R15 ci is permitted to be used or vice versa.
- (7) If an EF of a water tank is not indicated in a compliance package, there is no EF requirement for water tank for that specific compliance package.
- (8) Nominal and effective R values are expressed in (h·ft²·F)/Btu. U-Values are expressed in Btu/(h·ft²·F).

Table 3.1.1.2.B (SI)
ZONE 1 - Compliance Packages for Space Heating Equipment with $84\% \leq \text{AFUE} < 92\%$
 Forming Part of Sentence 3.1.1.2.(2)

Component	Thermal Values ⁽⁸⁾	Compliance Package					
		B1	B2	B3	B4	B5	B6
Ceiling with Attic Space	Min. Nominal RSI ⁽¹⁾	8.80	8.80	8.80	10.56 + HH	8.80	10.56
	Max. U ⁽²⁾	0.115	0.115	0.115	0.095	0.115	0.096
	Min. Effective RSI ⁽²⁾	8.67	8.67	8.67	10.55	8.67	10.43
Ceiling Without Attic Space	Min. Nominal RSI ⁽¹⁾	5.46	5.46	5.46	5.46	5.46	5.46
	Max. U ⁽²⁾	0.205	0.205	0.205	0.205	0.205	0.205
	Min. Effective RSI ⁽²⁾	4.87	4.87	4.87	4.87	4.87	4.87
Exposed Floor	Min. Nominal RSI ⁽¹⁾	6.16	6.16	6.16	5.46	6.16	5.46
	Max. U ⁽³⁾	0.177	0.177	0.177	0.190	0.177	0.190
	Min. Effective RSI ⁽³⁾	5.64	5.64	5.64	5.25	5.64	5.25
Walls Above Grade	Min. Nominal RSI ⁽¹⁾	3.87 + 0.88 ci	3.87 + 0.88 ci	3.87 + 1.32 ci	3.87 + 1.32 ci	3.34 + 1.76 ci	3.34 + 1.76 ci
	Max. U ⁽³⁾	0.265	0.265	0.238	0.238	0.224	0.224
	Min. Effective RSI ⁽³⁾	3.77	3.77	4.21	4.21	4.46	4.46
Basement Walls ⁽⁶⁾	Min. Nominal RSI ⁽¹⁾	3.52 ci	2.11 + 1.76 ci	3.52 ci	2.11 + 1.76 ci	3.52 ci	3.52 ci
	Max. U ⁽⁴⁾	0.269	0.272	0.269	0.272	0.269	0.269
	Min. Effective RSI ⁽⁴⁾	3.72	3.67	3.72	3.67	3.72	3.72
Below Grade Slab Entire Surface > 600 mm Below Grade	Min. Nominal RSI ⁽¹⁾	—	—	—	—	—	1.76
	Max. U ⁽⁴⁾	—	—	—	—	—	0.51
	Min. Effective RSI ⁽⁴⁾	—	—	—	—	—	1.96
Heated Slab or Slab ≤ 600 mm Below Grade	Min. Nominal RSI ⁽¹⁾	1.76	1.76	1.76	1.76	1.76	1.76
	Max. U ⁽⁴⁾	0.51	0.51	0.51	0.51	0.51	0.51
	Min. Effective RSI ⁽⁴⁾	1.96	1.96	1.96	1.96	1.96	1.96
Edge of Below Grade Slab ≤ 600 mm Below Grade	Min. Nominal RSI ⁽¹⁾	1.76	1.76	1.76	1.76	1.76	1.76
Windows and Sliding Glass Doors	Max. U ⁽⁵⁾	1.6	1.4	1.4	1.2	1.4	1.2
	Energy Rating	25	29	29	34	29	34
Skylights	Max. U ⁽⁵⁾	2.8	2.8	2.8	2.8	2.8	2.8
Space Heating Equipment	Min. AFUE	90%	90%	87%	87%	84%	84%
HRV	Min. SRE	75%	70%	70%	75%	75%	81%
Domestic Water Heater ⁽⁷⁾	Min. EF	0.66	0.62	0.66	—	0.66	—
Column 1	2	3	4	5	6	7	8

Notes to Table 3.1.1.2.B (SI):

The following definition applies: HH = 250 mm high heel

- (1) The values listed are minimum Nominal RSI-values for the thermal insulation component only.
- (2) U-Value and *effective RSI value* shall include entire ceiling assembly components, from interior air film to vented space air film above insulation.
- (3) U-Value and *effective RSI value* shall include entire exposed floor or above grade wall assembly components, from interior air film to exterior air film.
- (4) U-Value and *effective RSI value* shall include entire basement wall or slab assembly components and interior air film.
- (5) U-Value is the *overall coefficient of heat transfer* for a window assembly, sliding glass door assembly or skylight assembly expressed in W/(m²·K).
- (6) In the case of *basement* wall assemblies, where RSI 3.52 ci is required RSI 2.11 + 1.76 ci is permitted to be used or vice versa; or where RSI 2.11 + 0.88 ci is required, RSI 2.64 ci is permitted to be used or vice versa.
- (7) If an EF of a water tank is not indicated in a compliance package, there is no EF requirement for water tank for that specific compliance package.
- (8) Nominal and *effective RSI values* are expressed in (m²·K)/W. U-Values are expressed in W/(m²·K).

Table 3.1.1.2.B (IP)
ZONE 1 - Compliance Packages for Space Heating Equipment with $84\% \leq \text{AFUE} < 92\%$
 Forming Part of Sentence 3.1.1.2.(2)

Component	Thermal Values ⁽⁸⁾	Compliance Package					
		B1	B2	B3	B4	B5	B6
Ceiling with Attic Space	Min. Nominal R ⁽¹⁾	50	50	50	60 + HH	50	60
	Max. U ⁽²⁾	0.020	0.020	0.020	0.016	0.020	0.017
	Min. Effective R ⁽²⁾	49.23	49.23	49.23	59.90	49.23	59.22
Ceiling Without Attic Space	Min. Nominal R ⁽¹⁾	31	31	31	31	31	31
	Max. U ⁽²⁾	0.036	0.036	0.036	0.036	0.036	0.036
	Min. Effective R ⁽²⁾	27.65	27.65	27.65	27.65	27.65	27.65
Exposed Floor	Min. Nominal R ⁽¹⁾	35	35	35	31	35	31
	Max. U ⁽³⁾	0.031	0.031	0.031	0.034	0.031	0.034
	Min. Effective R ⁽³⁾	32.02	32.02	32.02	29.80	32.02	29.80
Walls Above Grade	Min. Nominal R ⁽¹⁾	22 + 5 ci	22 + 5 ci	22 + 7.5 ci	22 + 7.5 ci	19 + 10 ci	19 + 10 ci
	Max. U ⁽³⁾	0.047	0.047	0.042	0.042	0.040	0.040
	Min. Effective R ⁽³⁾	21.40	21.40	23.90	23.90	25.32	25.32
Basement Walls ⁽⁶⁾	Min. Nominal R ⁽¹⁾	20 ci	12 + 10 ci	20 ci	12 + 10 ci	20 ci	20 ci
	Max. U ⁽⁴⁾	0.047	0.048	0.047	0.048	0.047	0.047
	Min. Effective R ⁽⁴⁾	21.12	20.84	21.12	20.84	21.12	21.12
Below Grade Slab Entire Surface > 600 mm Below Grade	Min. Nominal R ⁽¹⁾	—	—	—	—	—	10
	Max. U ⁽⁴⁾	—	—	—	—	—	0.090
	Min. Effective R ⁽⁴⁾	—	—	—	—	—	11.13
Heated Slab or Slab ≤ 600 mm Below Grade	Min. Nominal R ⁽¹⁾	10	10	10	10	10	10
	Max. U ⁽⁴⁾	0.090	0.090	0.090	0.090	0.090	0.090
	Min. Effective R ⁽⁴⁾	11.13	11.13	11.13	11.13	11.13	11.13
Edge of Below Grade Slab ≤ 600 mm Below Grade	Min. Nominal R ⁽¹⁾	10	10	10	10	10	10
Windows and Sliding Glass	Max. U ⁽⁵⁾	0.28	0.25	0.25	0.21	0.25	0.21
	Energy Rating	25	29	29	34	29	34
Skylights	Max. U ⁽⁵⁾	0.49	0.49	0.49	0.49	0.49	0.49
Space Heating Equipment	Min. AFUE	90%	90%	87%	87%	84%	84%
HRV	SRE	75%	70%	70%	75%	75%	81%
Domestic Water Heater ⁽⁷⁾	Min. EF	0.66	0.62	0.66	—	0.66	—
Column 1	2	3	4	5	6	7	8

Notes to Table 3.1.1.2.B (IP):

The following definitions apply:

HH = 10 inch high heel

Nominal and effective R values are expressed in (h·ft²·F)/Btu. U-Values are expressed in Btu/(h·ft²·F).

(1) The values listed are minimum Nominal RSI-values for the thermal insulation component only.

(2) U-Value and effective R value shall include entire ceiling assembly components, from interior air film to vented space air film above insulation.

(3) U-Value and effective R value shall include entire exposed floor or above grade wall assembly components, from interior air film to exterior air film.

(4) U-Value and effective R value shall include entire basement wall or slab assembly components and interior air film.

(5) U-Value is the *overall coefficient of heat transfer* for a window assembly, sliding glass door assembly or skylight assembly expressed in Btu/(h·ft²·F).

(6) In the case of *basement* wall assemblies, where R20 ci is required R12 + 10 ci is permitted to be used or vice versa; or where R12 + 5 ci is required, R15 ci is permitted to be used or vice versa.

(7) If an EF of a water tank is not indicated in a compliance package, there is no EF requirement for water tank for that specific compliance package.

(8) Nominal and effective R values are expressed in (h·ft²·F)/Btu. U-Values are expressed in Btu/(h·ft²·F).

Table 3.1.1.2.C (SI)
 ZONE 1 - Compliance Packages for Electric Space Heating
 Forming Part of Sentence 3.1.1.2.(3)

Component	Thermal Values ⁽⁸⁾	Compliance Package			
		C1	C2	C3	C4
Ceiling with Attic Space	Min. Nominal RSI ⁽¹⁾	10.56 + HH	10.56 + HH	8.80	8.80
	Max. U ⁽²⁾	0.095	0.095	0.115	0.115
	Min. Effective RSI ⁽²⁾	10.55	10.55	8.67	8.67
Ceiling Without Attic Space	Min. Nominal RSI ⁽¹⁾	5.46	5.46	5.46	5.46
	Max. U ⁽²⁾	0.205	0.205	0.205	0.205
	Min. Effective RSI ⁽²⁾	4.87	4.87	4.87	4.87
Exposed Floor	Min. Nominal RSI ⁽¹⁾	5.46	5.46	6.16	6.16
	Max. U ⁽³⁾	0.190	0.190	0.177	0.177
	Min. Effective RSI ⁽³⁾	5.25	5.25	5.64	5.64
Walls Above Grade	Min. Nominal RSI ⁽¹⁾	3.34 + 1.76 ci	3.87 + 1.76 ci	3.87 + 1.76 ci	3.87 + 1.32 ci
	Max. U ⁽³⁾	0.224	0.215	0.215	0.238
	Min. Effective RSI ⁽³⁾	4.46	4.65	4.65	4.21
<i>Basement Walls</i> ⁽⁶⁾	Min. Nominal RSI ⁽¹⁾	3.52 + 1.40 ci	3.52 ci	3.52 ci	3.52 ci
	Max. U ⁽⁴⁾	0.250	0.269	0.269	0.269
	Min. Effective RSI ⁽⁴⁾	4.00	3.72	3.72	3.72
Below Grade Slab Entire Surface > 600 mm Below Grade	Min. Nominal RSI ⁽¹⁾	1.32	—	—	—
	Max. U ⁽⁴⁾	0.658	—	—	—
	Min. Effective RSI ⁽⁴⁾	1.52	—	—	—
Heated Slab or Slab ≤ 600 mm Below Grade	Min. Nominal RSI ⁽¹⁾	1.76	1.76	1.76	1.76
	Max. U ⁽⁴⁾	0.510	0.510	0.510	0.510
	Min. Effective RSI ⁽⁴⁾	1.96	1.96	1.96	1.96
Edge of Below Grade Slab ≤ 600 mm Below Grade	Min. Nominal RSI ⁽¹⁾	1.76	1.76	1.76	1.76
	Max. U ⁽⁵⁾	1.4	1.2	1.2	1.6
Windows and Sliding Glass Doors	Energy Rating	29	34	34	25
	Max. U ⁽⁵⁾	2.8	2.8	2.8	2.8
Skylights	Max. U ⁽⁵⁾	2.8	2.8	2.8	2.8
Space Heating Equipment	Min.	—	—	—	ASHP: 7.1 HSPF
HRV	Min. SRE	81%	75%	81%	55%
Domestic Water Heater ⁽⁷⁾	Min. EF	—	—	—	—
Column 1	2	3	4	5	6

Notes to Table 3.1.1.2.C (SI):

The following definitions apply:

HH = 250 mm high heel

- (1) The values listed are minimum Nominal RSI-values for the thermal insulation component only.
- (2) U-Value and *effective RSI value* shall include entire ceiling assembly components, from interior air film to vented space air film above insulation.
- (3) U-Value and *effective RSI value* shall include entire exposed floor or above grade wall assembly components, from interior air film to exterior air film.
- (4) U-Value and *effective RSI value* shall include entire basement wall or slab assembly components and interior air film.
- (5) U-Value is the *overall coefficient of heat transfer* for a window assembly, sliding glass door assembly or skylight assembly expressed in W/(m²·K).
- (6) In the case of *basement* wall assemblies, where RSI 3.52 ci is required RSI 2.11 + 1.76 ci is permitted to be used or vice versa; or where RSI 2.11 + 0.88 ci is required, RSI 2.64 ci is permitted to be used or vice versa.
- (7) If an EF of a water tank is not indicated in a compliance package, there is no EF requirement for water tank for that specific compliance package.
- (8) Nominal and *effective RSI values* are expressed in (m²·K)/W. U-Values are expressed in W/(m²·K).

e4

Table 3.1.1.2.C (IP)
ZONE 1 - Compliance Packages for Electric Space Heating
 Forming Part of Sentence 3.1.1.2.(3)

Component	Thermal Values ⁽⁸⁾	Compliance Package			
		C1	C2	C3	C4
Ceiling with Attic Space	Min. Nominal R ⁽¹⁾	60 + HH	60 + HH	50	50
	Max. U ⁽²⁾	0.016	0.016	0.020	0.020
	Min. Effective R ⁽²⁾	59.90	59.90	49.23	49.23
Ceiling Without Attic Space	Min. Nominal R ⁽¹⁾	31	31	31	31
	Max. U ⁽²⁾	0.036	0.036	0.036	0.036
	Min. Effective R ⁽²⁾	27.65	27.65	27.65	27.65
Exposed Floor	Min. Nominal R ⁽¹⁾	31	31	35	35
	Max. U ⁽³⁾	0.034	0.034	0.031	0.031
	Min. Effective R ⁽³⁾	29.80	29.80	32.02	32.02
Walls Above Grade	Min. Nominal R ⁽¹⁾	19 + 10 ci	22 + 10 ci	22 + 10 ci	22 + 7.5 ci
	Max. U ⁽³⁾	0.040	0.038	0.038	0.042
	Min. Effective R ⁽³⁾	25.32	26.40	26.40	23.90
Basement Walls ⁽⁶⁾	Min. Nominal R ⁽¹⁾	20 + 8 ci	20 ci	20 ci	20 ci
	Max. U ⁽⁴⁾	0.044	0.047	0.047	0.047
	Min. Effective R ⁽⁴⁾	22.71	21.12	21.12	21.12
Below Grade Slab Entire Surface > 600 mm Below Grade	Min. Nominal R ⁽¹⁾	7.5	—	—	—
	Max. U ⁽⁴⁾	0.116	—	—	—
	Min. Effective R ⁽⁴⁾	8.63	—	—	—
Heated Slab or Slab ≤ 600 mm Below Grade	Min. Nominal R ⁽¹⁾	10	10	10	10
	Max. U ⁽⁴⁾	0.090	0.090	0.090	0.090
	Min. Effective R ⁽⁴⁾	11.13	11.13	11.13	11.13
Edge of Below Grade Slab ≤ 600 mm Below Grade	Min. Nominal R ⁽¹⁾	10	10	10	10
Windows and Sliding Glass Doors	Max. U ⁽⁵⁾	0.25	0.21	0.21	0.28
	Energy Rating	29	34	34	25
Skylights	Max. U ⁽⁵⁾	0.49	0.49	0.49	0.49
Space Heating Equipment	Min.	—	—	—	ASHP: 7.1 HSPF
HRV	Min. SRE	81%	75%	81%	55%
Domestic Water Heater ⁽⁷⁾	Min. EF	—	—	—	—
Column 1	2	3	4	5	6

Notes to Table 3.1.1.2.C (IP):

The following definitions applies:

HH = 10 inch high heel

(1) The values listed are minimum Nominal R values for the thermal insulation component only.

(2) U-Value and effective R value shall include entire ceiling assembly components, from interior air film to vented space air film above insulation.

(3) U-Value and effective R value shall include entire exposed floor or above grade wall assembly components, from interior air film to exterior air film.

(4) U-Value and effective R value shall include entire basement wall or slab assembly components and interior air film.

(5) U-Value is the *overall coefficient of heat transfer* for a window assembly, sliding glass door assembly or skylight assembly expressed in Btu/(h·ft²·F).

(6) In the case of *basement* wall assemblies, where R20 ci is required R12 + 10 ci is permitted to be used or vice versa; or where R12 + 5 ci is required, R15 ci is permitted to be used or vice versa.

(7) If an EF of a water tank is not indicated in a compliance package, there is no EF requirement for water tank for that specific compliance package.

(8) Nominal and effective R values are expressed in (h·ft²·F)/Btu. U-Values are expressed in Btu/(h·ft²·F).

3.1.1.3. Energy Efficiency for Buildings Located in Zone 2

- (1) Except as provided in Sentences (2) to (5) and (7), the minimum thermal performance of *building* envelope and equipment shall conform to Table 3.1.1.3.A.
- (2) Except for solid fuel-burning space heating equipment and except as permitted in Sentence (5), where the space heating equipment efficiency is 84% or more but less than 92%, the minimum thermal performance of the *building* envelope and equipment shall conform to Table 3.1.1.3.B.
- (3) Where *electric space heating* is used, the minimum thermal performance of the *building* envelope and equipment shall conform to Table 3.1.1.3.C.
- (4) Except as permitted in Sentence (5), where the space heating equipment efficiency cannot meet the requirements of the applicable compliance packages, energy efficiency compliance shall be achieved in accordance with Subsection 3.1.2. of this Supplementary Standard.
- (5) Where an ICF wall assembly is installed as an above and below grade wall assembly that has minimum RSI 1.76 (R10) insulation on the interior surface of the concrete and minimum RSI 1.76 (R10) insulation on the exterior surface, the ICF wall is deemed to comply with the thermal values set out for walls in compliance packages A1 and A3 in Table 3.1.1.3.A. (See Appendix A.)
- (6) An ICF wall assembly described in Sentence (5) is permitted to be used in lieu of *basement* walls that require insulation value of RSI 3.52 ci (R20) or less. (See Appendix A.)
- (7) *Building* designs that utilize combined space heating and domestic water heating systems are permitted to use compliance package A4 or A5, provided that
 - (a) the water heating equipment has a minimum of 0.80 EF, 90% AFUE, or is a condensing type, or,
 - (b) the combination of equipment has a minimum of 0.85 TPF determined in accordance with CAN/CSA-P.9, “Test Method for Determining the Performance of Combined Space and Water Heating Systems (Combos)”.

Table 3.1.1.3.A (SI)
ZONE 2 - Compliance Packages for Space Heating Equipment with AFUE ≥ 92%
 Forming Part of Sentence 3.1.1.3.(1)

Component	Thermal Values ⁽⁸⁾	Compliance Package					
		A1	A2	A3	A4	A5	A6
Ceiling with Attic Space	Min. Nominal RSI ⁽¹⁾	10.56	8.80	10.56 + HH	10.56	10.56	8.80
	Max. U ⁽²⁾	0.096	0.115	0.095	0.096	0.096	0.115
	Min. Effective RSI ⁽²⁾	10.43	8.67	10.55	10.43	10.43	8.67
Ceiling Without Attic Space	Min. Nominal RSI ⁽¹⁾	5.46	5.46	5.46	5.46	5.46	5.46
	Max. U ⁽²⁾	0.205	0.205	0.205	0.205	0.205	0.205
	Min. Effective RSI ⁽²⁾	4.87	4.87	4.87	4.87	4.87	4.87
Exposed Floor	Min. Nominal RSI ⁽¹⁾	5.46	6.16	5.46	5.46	5.46	6.16
	Max. U ⁽³⁾	0.190	0.177	0.190	0.190	0.190	0.177
	Min. Effective RSI ⁽³⁾	5.25	5.64	5.25	5.25	5.25	5.64
Walls Above Grade	Min. Nominal RSI ⁽¹⁾	3.34 + 0.88 ci	3.34 + 1.76 ci	3.87 + 0.88 ci	3.87 + 1.32 ci	3.34 + 1.76 ci	3.87 + 1.32 ci
	Max. U ⁽³⁾	0.280	0.224	0.265	0.238	0.224	0.238
	Min. Effective RSI ⁽³⁾	3.58	4.46	3.77	4.21	4.46	4.21
Basement Walls ⁽⁶⁾	Min. Nominal RSI ⁽¹⁾	3.52 ci	3.52 ci	3.52 ci	3.52 ci	3.52 ci	3.52 ci
	Max. U ⁽⁴⁾	0.269	0.269	0.269	0.269	0.269	0.269
	Min. Effective RSI ⁽⁴⁾	3.72	3.72	3.72	3.72	3.72	3.72
Below Grade Slab Entire Surface > 600 mm Below Grade	Min. Nominal RSI ⁽¹⁾	—	—	0.88	—	1.76	1.32
	Max. U ⁽⁴⁾	—	—	0.926	—	0.51	0.658
	Min. Effective RSI ⁽⁴⁾	—	—	1.08	—	1.96	1.52
Heated Slab or Slab ≤ 600 mm Below Grade	Min. Nominal RSI ⁽¹⁾	1.76	1.76	1.76	1.76	1.76	1.76
	Max. U ⁽⁴⁾	0.510	0.510	0.510	0.510	0.510	0.510
	Min. Effective RSI ⁽⁴⁾	1.96	1.96	1.96	1.96	1.96	1.96
Edge of Below Grade Slab ≤ 600 mm Below Grade	Min. Nominal RSI ⁽¹⁾	1.76	1.76	1.76	1.76	1.76	1.76
Windows and Sliding Glass Doors	Max. U ⁽⁵⁾	1.2	1.6	1.6	1.2	1.4	1.4
	Energy Rating	34	25	25	34	29	29
Skylights	Max. U ⁽⁵⁾	2.8	2.8	2.8	2.8	2.8	2.8
Space Heating Equipment	Min. AFUE	96%	96%	98%	96%	94%	92%
HRV	Min. SRE	81%	70%	65%	65%	65%	75%
Domestic Water Heater ⁽⁷⁾	Min. EF	0.70	0.80	0.80	0.67	0.67	0.70
Column 1	2	3	4	5	6	7	8

Notes to Table 3.1.1.3.A (SI):

The following definition applies:

HH = 250 mm high heel

- (1) The values listed are minimum Nominal RSI-values for the thermal insulation component only.
- (2) U-Value and *effective RSI value* shall include entire ceiling assembly components, from interior air film to vented space air film above insulation.
- (3) U-Value and *effective RSI value* shall include entire exposed floor or above grade wall assembly components, from interior air film to exterior air film.
- (4) U-Value and *effective RSI value* shall include entire basement wall or slab assembly components and interior air film.
- (5) U-Value is the *overall coefficient of heat transfer* for a window assembly, sliding glass door assembly or skylight assembly expressed in $W/(m^2 \cdot K)$.
- (6) In the case of *basement* wall assemblies, where RSI 3.52 ci is required RSI 2.11 + 1.76 ci is permitted to be used or vice versa; or where RSI 2.11 + 0.88 ci is required, RSI 2.64 ci is permitted to be used or vice versa.
- (7) If an EF of a water tank is not indicated in a compliance package, there is no EF requirement for water tank for that specific compliance package.
- (8) Nominal and *effective RSI values* are expressed in $(m^2 \cdot K)/W$. U-Values are expressed in $W/(m^2 \cdot K)$.

Table 3.1.1.3.A (IP)
 ZONE 2 - Compliance Packages for Space Heating Equipment with AFUE \geq 92%
 Forming Part of Sentence 3.1.1.3.(1)

Component	Thermal Values ⁽⁸⁾	Compliance Package					
		A1	A2	A3	A4	A5	A6
Ceiling with Attic Space	Min. Nominal R ⁽¹⁾	60	50	60+HH	60	60	50
	Max. U ⁽²⁾	0.017	0.020	0.016	0.017	0.017	0.020
	Min. Effective R ⁽²⁾	59.22	49.23	59.90	59.22	59.22	49.23
Ceiling Without Attic Space	Min. Nominal R ⁽¹⁾	31	31	31	31	31	31
	Max. U ⁽²⁾	0.036	0.036	0.036	0.036	0.036	0.036
	Min. Effective R ⁽²⁾	27.65	27.65	27.65	27.65	27.65	27.65
Exposed Floor	Min. Nominal R ⁽¹⁾	31	35	31	31	31	35
	Max. U ⁽³⁾	0.034	0.031	0.034	0.034	0.034	0.031
	Min. Effective R ⁽³⁾	29.80	32.02	29.80	29.80	29.80	32.02
Walls Above Grade	Min. Nominal R ⁽¹⁾	19 + 5 ci	19 + 10 ci	22 + 5 ci	22 + 7.5 ci	19 + 10 ci	22 + 7.5 ci
	Max. U ⁽³⁾	0.049	0.040	0.047	0.042	0.040	0.042
	Min. Effective R ⁽³⁾	20.32	25.32	21.40	23.90	25.32	23.90
Basement Walls ⁽⁶⁾	Min. Nominal R ⁽¹⁾	20 ci	20 ci	20 ci	20 ci	20 ci	20 ci
	Max. U ⁽⁴⁾	0.047	0.047	0.047	0.047	0.047	0.047
	Min. Effective R ⁽⁴⁾	21.12	21.12	21.12	21.12	21.12	21.12
Below Grade Slab Entire Surface > 600 mm Below Grade	Min. Nominal R ⁽¹⁾	—	—	5	—	10	7.5
	Max. U ⁽⁴⁾	—	—	0.163	—	0.090	0.116
	Min. Effective R ⁽⁴⁾	—	—	6.13	—	11.13	8.63
Heated Slab or Slab \leq 600 mm Below Grade	Min. Nominal R ⁽¹⁾	10	10	10	10	10	10
	Max. U ⁽⁴⁾	0.090	0.090	0.090	0.090	0.090	0.090
	Min. Effective R ⁽⁴⁾	11.13	11.13	11.13	11.13	11.13	11.13
Edge of Below Grade Slab \leq 600 mm Below Grade	Min. Nominal R ⁽¹⁾	10	10	10	10	10	10
Windows and Sliding Glass Doors	Max. U ⁽⁵⁾	0.21	0.28	0.28	0.21	0.25	0.25
	Energy Rating	34	25	25	34	29	29
Skylights	Max. U ⁽⁵⁾	0.49	0.49	0.49	0.49	0.49	0.49
Space Heating Equipment	Min. AFUE	96%	96%	98%	96%	94%	92%
HRV	Min. SRE	81%	70%	65%	65%	65%	75%
Domestic Water Heater ⁽⁷⁾	Min. EF	0.70	0.80	0.80	0.67	0.67	0.70
Column 1	2	3	4	5	6	7	8

Notes to Table 3.1.1.3.A (IP):

The following definition applies:

HH = 10 inch high heel

- (1) The values listed are minimum Nominal RSI-values for the thermal insulation component only.
- (2) U-Value and effective R value shall include entire ceiling assembly components, from interior air film to vented space air film above insulation.
- (3) U-Value and effective R value shall include entire exposed floor or above grade wall assembly components, from interior air film to exterior air film.
- (4) U-Value and effective R value shall include entire *basement* wall or slab assembly components and interior air film.
- (5) U-Value is the *overall coefficient of heat transfer* for a window assembly, sliding glass door assembly or skylight assembly expressed in Btu/(h·ft²·F).
- (6) In the case of *basement* wall assemblies, where R20 ci is required R12 + 10 ci is permitted to be used or vice versa; or where R12 + 5 ci is required, R15 ci is permitted to be used or vice versa.
- (7) If an EF of a water tank is not indicated in a compliance package, there is no EF requirement for water tank for that specific compliance package.
- (8) Nominal and effective R values are expressed in (h·ft²·F)/Btu. U-Values are expressed in Btu/(h·ft²·F).

Table 3.1.1.3.B (SI)
 ZONE 2 - Compliance Packages for Space Heating Equipment with $84\% \leq \text{AFUE} < 92\%$
 Forming Part of Sentence 3.1.1.3.(2)

Component	Thermal Values ⁽⁸⁾	Compliance Package					
		B1	B2	B3	B4	B5	B6
Ceiling with Attic Space	Min. Nominal RSI ⁽¹⁾	8.80	10.56	10.56 + HH	10.56 + HH	8.80	10.56
	Max. U ⁽²⁾	0.115	0.096	0.095	0.095	0.115	0.096
	Min. Effective RSI ⁽²⁾	8.67	10.43	10.55	10.55	8.67	10.43
Ceiling Without Attic Space	Min. Nominal RSI ⁽¹⁾	5.46	5.46	5.46	5.46	5.46	5.46
	Max. U ⁽²⁾	0.205	0.205	0.205	0.205	0.205	0.205
	Min. Effective RSI ⁽²⁾	4.87	4.87	4.87	4.87	4.87	4.87
Exposed Floor	Min. Nominal RSI ⁽¹⁾	6.16	5.46	5.46 + 1.76 ci	5.46	6.16	5.46
	Max. U ⁽³⁾	0.177	0.190	0.143	0.190	0.177	0.190
	Min. Effective RSI ⁽³⁾	5.64	5.25	7.01	5.25	5.64	5.25
Walls Above Grade	Min. Nominal RSI ⁽¹⁾	3.87 + 1.32 ci	3.87 + 1.32 ci	3.87 + 1.76 ci	3.87 + 1.76 ci	3.87 + 1.76 ci	3.87 + 1.76 ci
	Max. U ⁽³⁾	0.238	0.238	0.215	0.215	0.215	0.215
	Min. Effective RSI ⁽³⁾	4.21	4.21	4.65	4.65	4.65	4.65
Basement Walls ⁽⁶⁾	Min. Nominal RSI ⁽¹⁾	3.52 ci	2.11 + 1.76 ci	3.52 + 1.76 ci	3.52 + 1.76 ci	3.52 + 2.11 ci	3.52 + 2.11 ci
	Max. U ⁽⁴⁾	0.269	0.272	0.226	0.226	0.213	0.213
	Min. Effective RSI ⁽⁴⁾	3.72	3.67	4.43	4.43	4.7	4.7
Below Grade Slab Entire Surface > 600 mm Below Grade	Min. Nominal RSI ⁽¹⁾	—	0.88	1.76	1.76	0.88	0.88
	Max. U ⁽⁴⁾	—	0.926	0.510	0.510	0.926	0.926
	Min. Effective RSI ⁽⁴⁾	—	1.08	1.96	1.96	1.08	1.08
Heated Slab or Slab ≤ 600 mm Below Grade	Min. Nominal RSI ⁽¹⁾	1.76	1.76	1.76	1.76	1.76	1.76
	Max. U ⁽⁴⁾	0.510	0.510	0.510	0.510	0.510	0.510
	Min. Effective RSI ⁽⁴⁾	1.96	1.96	1.96	1.96	1.96	1.96
Edge of Below Grade Slab ≤ 600 mm Below Grade	Min. Nominal RSI ⁽¹⁾	1.76	1.76	1.76	1.76	1.76	1.76
Windows and Sliding Glass Doors	Max. U ⁽⁵⁾	1.2	1.6	1.4	1.4	1.4	1.2
	Energy Rating	34	25	29	29	29	34
Skylights	Max. U ⁽⁵⁾	2.8	2.8	2.8	2.8	2.8	2.8
Space Heating Equipment	Min. AFUE	90%	90%	87%	87%	84%	84%
HRV	Min. SRE	75%	81%	70%	75%	81%	81%
Domestic Water Heater ⁽⁷⁾	Min. EF	0.66	0.66	0.66	0.62	0.66	—
Column 1	2	3	4	5	6	7	8

Notes to Table 3.1.1.3.B (SI):

The following definition applies:

HH = 250 mm high heel

(1) The values listed are minimum Nominal RSI-values for the thermal insulation component only.

(2) U-Value and *effective RSI value* shall include entire ceiling assembly components, from interior air film to vented space air film above insulation.

(3) U-Value and *effective RSI value* shall include entire exposed floor or above grade wall assembly components, from interior air film to exterior air film.

(4) U-Value and *effective RSI value* shall include entire *basement* wall or slab assembly components and interior air film.

(5) U-Value is the *overall coefficient of heat transfer* for a window assembly, sliding glass door assembly or skylight assembly expressed in $W/(m^2 \cdot K)$.

(6) In the case of *basement* wall assemblies, where RSI 3.52 ci is required RSI 2.11 + 1.76 ci is permitted to be used or vice versa; or where RSI 2.11 + 0.88 ci is required, RSI 2.64 ci is permitted to be used or vice versa.

(7) If an EF of a water tank is not indicated in a compliance package, there is no EF requirement for water tank for that specific compliance package.

(8) Nominal and *effective RSI values* are expressed in $(m^2 \cdot K)/W$. U-Values are expressed in $W/(m^2 \cdot K)$.

Table 3.1.1.3.B (IP)
 ZONE 2 - Compliance Packages for Space Heating Equipment with $84\% \leq \text{AFUE} < 92\%$
 Forming Part of Sentence 3.1.1.3.(2)

Component	Thermal Values ⁽⁶⁾	Compliance Package					
		B1	B2	B3	B4	B5	B6
Ceiling with Attic Space	Min. Nominal R ⁽¹⁾	50	60	60 + HH	60 + HH	50	60
	Max. U ⁽²⁾	0.020	0.017	0.016	0.016	0.020	0.017
	Min. Effective R ⁽²⁾	49.23	59.22	59.90	59.90	49.23	59.22
Ceiling Without Attic Space	Min. Nominal R ⁽¹⁾	31	31	31	31	31	31
	Max. U ⁽²⁾	0.036	0.036	0.036	0.036	0.036	0.036
	Min. Effective R ⁽²⁾	27.65	27.65	27.65	27.65	27.65	27.65
Exposed Floor	Min. Nominal R ⁽¹⁾	35	31	31 + 10 ci	31	35	31
	Max. U ⁽³⁾	0.031	0.034	0.025	0.034	0.031	0.034
	Min. Effective R ⁽³⁾	32.02	29.80	39.80	29.80	32.02	29.80
Walls Above Grade	Min. Nominal R ⁽¹⁾	22 + 7.5 ci	22 + 7.5 ci	22 + 10 ci	22 + 10 ci	22 + 10 ci	22 + 10 ci
	Max. U ⁽³⁾	0.042	0.042	0.038	0.038	0.038	0.038
	Min. Effective R ⁽³⁾	23.90	23.90	26.40	26.40	26.40	26.40
Basement Walls ⁽⁶⁾	Min. Nominal R ⁽¹⁾	20 ci	12 + 10 ci	20 + 10 ci	20 + 10 ci	20 + 12 ci	20 + 12 ci
	Max. U ⁽⁴⁾	0.047	0.048	0.040	0.040	0.037	0.037
	Min. Effective R ⁽⁴⁾	21.12	20.84	25.15	25.15	26.69	26.69
Below Grade Slab Entire Surface > 600 mm Below Grade	Min. Nominal R ⁽¹⁾	—	5	10	10	5	5
	Max. U ⁽⁴⁾	—	0.163	0.090	0.090	0.163	0.163
	Min. Effective R ⁽⁴⁾	—	6.13	11.13	11.13	6.13	6.13
Heated Slab or Slab ≤ 600 mm Below Grade	Min. Nominal R ⁽¹⁾	10	10	10	10	10	10
	Max. U ⁽⁴⁾	0.090	0.090	0.090	0.090	0.090	0.090
	Min. Effective R ⁽⁴⁾	11.13	11.13	11.13	11.13	11.13	11.13
Edge of Below Grade Slab ≤ 600 mm Below Grade	Min. Nominal R ⁽¹⁾	10	10	10	10	10	10
Windows and Sliding Glass Doors	Max. U ⁽⁵⁾	0.21	0.28	0.25	0.25	0.25	0.21
	Energy Rating	34	25	29	29	29	34
Skylights	Max. U ⁽⁵⁾	0.49	0.49	0.49	0.49	0.49	0.49
Space Heating Equipment	Min. AFUE	90%	90%	87%	87%	84%	84%
HRV	Min. SRE	75%	81%	70%	75%	81%	81%
Domestic Water Heater ⁽⁷⁾	Min. EF	0.66	0.66	0.66	0.62	0.66	—
Column 1	2	3	4	5	6	7	8

Notes to Table 3.1.1.3.B (IP):

The following definition applies:

HH = 10 inch high heel

- (1) The values listed are minimum Nominal R values for the thermal insulation component only.
- (2) U-Value and effective R value shall include entire ceiling assembly components, from interior air film to vented space air film above insulation.
- (3) U-Value and effective R value shall include entire exposed floor or above grade wall assembly components, from interior air film to exterior air film.
- (4) U-Value and effective R value shall include entire *basement* wall or slab assembly components and interior air film.
- (5) U-Value is the *overall coefficient of heat transfer* for a window assembly, sliding glass door assembly or skylight assembly expressed in Btu/(h·ft²·F).
- (6) In the case of *basement* wall assemblies, where R20 ci is required R12 + 10 ci is permitted to be used or vice versa; or where R12 + 5 ci is required, R15 ci is permitted to be used or vice versa.
- (7) If an EF of a water tank is not indicated in a compliance package, there is no EF requirement for water tank for that specific compliance package.
- (8) Nominal and effective R values are expressed in (h·ft²·F)/Btu. U-Values are expressed in Btu/(h·ft²·F).

Table 3.1.1.3.C (SI)
 ZONE 2 - Compliance Packages for Electric Space Heating
 Forming Part of Sentence 3.1.1.3.(3)

Component	Thermal Values ⁽⁸⁾	Compliance Package	
		C1	C2
Ceiling with Attic Space	Min. Nominal RSI ⁽¹⁾	10.56 + HH	8.80
	Max. U ⁽²⁾	0.095	0.115
	Min. Effective RSI ⁽²⁾	10.55	8.67
Ceiling Without Attic Space	Min. Nominal RSI ⁽¹⁾	5.46	5.46
	Max. U ⁽²⁾	0.205	0.205
	Min. Effective RSI ⁽²⁾	4.87	4.87
Exposed Floor	Min. Nominal RSI ⁽¹⁾	5.46 + 1.76 ci	6.16
	Max. U ⁽³⁾	0.143	0.177
	Min. Effective RSI ⁽³⁾	7.01	5.64
Walls Above Grade	Min. Nominal RSI ⁽¹⁾	4.22 + 1.76 ci	3.87 + 1.32 ci
	Max. U ⁽³⁾	0.210	0.238
	Min. Effective RSI ⁽³⁾	4.76	4.21
<i>Basement Walls</i> ⁽⁶⁾	Min. Nominal RSI ⁽¹⁾	3.52 + 2.11 ci	3.52 ci
	Max. U ⁽⁴⁾	0.213	0.269
	Min. Effective RSI ⁽⁴⁾	4.7	3.72
Below Grade Slab Entire Surface > 600 mm Below Grade	Min. Nominal RSI ⁽¹⁾	1.76	—
	Max. U ⁽⁴⁾	0.51	—
	Min. Effective RSI ⁽⁴⁾	1.96	—
Heated Slab or Slab ≤ 600 mm Below Grade	Min. Nominal RSI ⁽¹⁾	1.76	1.76
	Max. U ⁽⁴⁾	0.510	0.510
	Min. Effective RSI ⁽⁴⁾	1.96	1.96
Edge of Below Grade Slab ≤ 600 mm Below Grade	Min. Nominal RSI ⁽¹⁾	1.76	1.76
Windows and Sliding Glass Doors	Max. U ⁽⁵⁾	1.2	1.6
	Energy Rating	34	25
Skylights	Max. U ⁽⁵⁾	2.8	2.8
Space Heating Equipment	Min.	—	ASHP: 7.1 HSPF
HRV	Min. SRE	81%	70%
Domestic Water Heater ⁽⁷⁾	Min. EF	—	—
Column 1	2	3	4

Notes to Table 3.1.1.2.C (SI):

The following definition applies: HH = 250 mm high heel

- (1) The values listed are minimum Nominal RSI-values for the thermal insulation component only.
- (2) U-Value and *effective RSI value* shall include entire ceiling assembly components, from interior air film to vented space air film above insulation.
- (3) U-Value and *effective RSI value* shall include entire exposed floor or above grade wall assembly components, from interior air film to exterior air film.
- (4) U-Value and *effective RSI value* shall include entire *basement* wall or slab assembly components and interior air film.
- (5) U-Value is the *overall coefficient of heat transfer* for a window assembly, sliding glass door assembly or skylight assembly expressed in W/(m²·K).
- (6) In the case of *basement* wall assemblies, where RSI 3.52 ci is required RSI 2.11 + 1.76 ci is permitted to be used or vice versa; or where RSI 2.11 + 0.88 ci is required, RSI 2.64 ci is permitted to be used or vice versa.
- (7) If an EF of a water tank is not indicated in a compliance package, there is no EF requirement for water tank for that specific compliance package.
- (8) Nominal and *effective RSI values* are expressed in (m²·K)/W. U-Values are expressed in W/(m²·K).

Table 3.1.1.3.C (IP)
 ZONE 2 - Compliance Packages for Electric Space Heating
 Forming Part of Sentence 3.1.1.3.(3)

Component	Thermal Values ⁽⁸⁾	Compliance Package	
		C1	C2
Ceiling with Attic Space	Min. Nominal R ⁽¹⁾	60 + HH	50
	Max. U ⁽²⁾	0.016	0.020
	Min. Effective R ⁽²⁾	59.90	49.23
Ceiling Without Attic Space	Min. Nominal R ⁽¹⁾	31	31
	Max. U ⁽²⁾	0.036	0.036
	Min. Effective R ⁽²⁾	27.65	27.65
Exposed Floor	Min. Nominal R ⁽¹⁾	31 + 10 ci	35
	Max. U ⁽³⁾	0.025	0.031
	Min. Effective R ⁽³⁾	39.80	32.02
Walls Above Grade	Min. Nominal R ⁽¹⁾	24 + 10 ci	22 + 7.5 ci
	Max. U ⁽³⁾	0.037	0.042
	Min. Effective R ⁽³⁾	27.02	23.90
<i>Basement Walls</i> ⁽⁶⁾	Min. Nominal R ⁽¹⁾	20 + 12 ci	20 ci
	Max. U ⁽⁴⁾	0.037	0.047
	Min. Effective R ⁽⁴⁾	26.69	21.12
Below Grade Slab Entire Surface > 600 mm Below Grade	Min. Nominal R ⁽¹⁾	10.0	—
	Max. U ⁽⁴⁾	0.090	—
	Min. Effective R ⁽⁴⁾	11.13	—
Heated Slab or Slab ≤ 600 mm Below Grade	Min. Nominal R ⁽¹⁾	10	10
	Max. U ⁽⁴⁾	0.090	0.090
	Min. Effective R ⁽⁴⁾	11.13	11.13
Edge of Below Grade Slab ≤ 600 mm Below Grade	Min. Nominal R ⁽¹⁾	10	10
	Max. U ⁽⁵⁾	0.21	0.28
Windows and Sliding Glass Doors	Energy Rating	34	25
	Max. U ⁽⁵⁾	0.49	0.49
Skylights	Max. U ⁽⁵⁾	0.49	0.49
Space Heating Equipment	Min.	—	ASHP: 7.1 HSPF
HRV	Min. SRE	81%	70%
Domestic Water Heater ⁽⁷⁾	Min. EF	—	—
Column 1	2	3	4

Notes to Table 3.1.1.3.C (IP):

The following definition applies:

HH = 10 inch high heel

- (1) The values listed are minimum Nominal R values for the thermal insulation component only.
- (2) U-Value and effective R value shall include entire ceiling assembly components, from interior air film to vented space air film above insulation.
- (3) U-Value and effective R value shall include entire exposed floor or above grade wall assembly components, from interior air film to exterior air film.
- (4) U-Value and effective R value shall include entire *basement* wall or slab assembly components and interior air film.
- (5) U-Value is the *overall coefficient of heat transfer* for a window assembly, sliding glass door assembly or skylight assembly expressed in Btu/(h·ft²·F).
- (6) In the case of *basement* wall assemblies, where R20 ci is required R12 + 10 ci is permitted to be used or vice versa; or where R12 + 5 ci is required, R15 ci is permitted to be used or vice versa
- (7) If an EF of a water tank is not indicated in a compliance package, there is no EF requirement for water tank for that specific compliance package.
- (8) Nominal and effective R values are expressed in (h·ft²·F)/Btu. U-Values are expressed in Btu/(h·ft²·F).

3.1.1.4. Airtightness (See Appendix A)

(1) Where a *dwelling unit* is designed and *constructed* to be sufficiently airtight such that the air leakage of the whole *dwelling unit* is less than or equal to one of the applicable airtightness targets specified in the same row of Table 3.1.1.4.A, the requirements of Tables 3.1.1.2.A to 3.1.1.2.C, Tables 3.1.1.3.A to 3.1.1.3.C, and Table 3.1.1.11. are permitted to be substituted in accordance with Table 3.1.1.4.B or Table 3.1.1.4.C.

(2) Airtightness targets described in Sentence (1) shall be measured under as operated conditions in accordance with CAN/CGSB 149.10 “Determination of the Airtightness of *Building* Envelopes by the Fan Depressurization Method” or NRCan, “EnerGuide Rating System Technical Procedures Version 15.1”.

(3) For purposes of substitutions described in Sentence (1),

- (a) a maximum of one substitution per *dwelling unit* may be made if substitutions are made in accordance with Table 3.1.1.4.B, or
- (b) a maximum of two substitutions per *dwelling unit* may be made if substitutions are made in accordance with Table 3.1.1.4.C.

e4 **Table 3.1.1.4.A**
Airtightness Targets
Forming Part of Sentence 3.1.1.4.(1) and Subsection 3.1.2.

Building Type	Airtightness Targets				
	ACH @ 50Pa	NLA @ 10 Pa		NLR @ 50 Pa	
		cm ² /m ²	in ² /100 ft ²	L/s/m ²	cfm/ft ²
Detached	2.5	1.26	1.81	0.93	0.18
Attached	3.0	2.12	3.06	1.32	0.26
Column 1	2	3	4	5	6

Table 3.1.1.4.B (SI)
Permitted Substitutions for Airtight Dwelling Units⁽²⁾
Forming Part of Sentences 3.1.1.4.(1) and (3)

Required Compliance	Permitted Substitution Airtightness Complies with Table 3.1.1.4.A ⁽¹⁾
Maximum One Substitution per <i>Dwelling Unit</i>	
RSI 3.87 + 1.32 ci	RSI 3.34 + 0.88 ci
RSI 3.87 + 1.76 ci	RSI 3.34 + 1.32 ci
RSI 4.22 + 1.76 ci	RSI 3.87 + 1.32 ci
HRV with 81% SRE	HRV with 70% SRE
HRV with 75% SRE	HRV with 65% SRE
Furnace with 98%, 96% or 94% AFUE	Reduce furnace efficiency by 4% AFUE
<i>Fenestration</i> U-Value = 1.6, 1.4 or 1.2	Increase U-Value by 0.2
Column 1	2

Notes to Table 3.1.1.4.B (SI):

- (1) Where nominal RSI values are given, the use of corresponding U-Value or *effective RSI values* are permitted.
- (2) Use only Table 3.1.1.4.B or Table 3.1.1.4.C, not both.

e4

Table 3.1.1.4.B (IP)
Permitted Substitutions for Airtight Dwelling Units⁽²⁾
 Forming Part of Sentence 3.1.1.4.(1)

Required Compliance	Permitted Substitution Airtightness Complies with Table 3.1.1.4.A ⁽¹⁾
Maximum One Substitution per <i>Dwelling Unit</i>	
R22 + 7.5 ci	R19 + 5 ci
R22 + 10 ci	R19 + 7.5 ci
R24 + 10 ci	R22 + 7.5 ci
HRV with 81% SRE	HRV with 70% SRE
HRV with 75% SRE	HRV with 65% SRE
Furnace with 98%, 96% or 94% AFUE	Reduce furnace efficiency by 4% AFUE
<i>Fenestration</i> U-Value = 0.28, 0.25 or 0.21	Increase U-Value by 0.04 (downgrade one level)
Column 1	2

Notes to Table 3.1.1.4.B (IP):

- (1) Where nominal R values are given, the use of corresponding "U" or "effective R" values are permitted.
 (2) Use only Table 3.1.1.4.B or Table 3.1.1.4.C, not both.

e4

Table 3.1.1.4.C (SI)
Permitted Substitutions for Airtight Dwelling Units⁽³⁾
 Forming Part of Sentences 3.1.1.4.(1) and (3)

Required Compliance	Permitted Substitutions Airtightness Complies with Table 3.1.1.4.A ⁽¹⁾
Maximum Two Substitutions per <i>Dwelling Unit</i> ⁽²⁾	
Above grade continuous wall insulation RSI 1.32 ci or RSI 1.76 ci	Above grade continuous wall insulation RSI 0.88 ci or RSI 1.32 ci respectively
RSI 3.87 or RSI 4.22 insulation between studs in above grade walls with continuous insulation	RSI 3.34 or RSI 3.87 insulation respectively between studs in above grade walls with continuous insulation
<i>Basement</i> wall RSI 3.52 + 2.11 ci, RSI 3.52 + 1.76 ci or RSI 3.52 ci	<i>Basement</i> wall RSI 2.64 ci or RSI 2.11 + 0.88 ci
Slab located more than 600 mm below grade and entire under slab insulation is RSI 1.76 or RSI 0.88	RSI 0, if slab is unheated RSI 0.88, if slab is heated
RSI 10.56 ceiling insulation with or without 250 mm high heel	RSI 8.80 ceiling insulation
Column 1	2

Notes to Table 3.1.1.4.C (SI):

- (1) Where nominal RSI values are given, the use of corresponding U-Value or *effective RSI values* are permitted.
 (2) Where the required airtightness is achieved, simultaneous substitution of two components listed in this Table is permitted.
 (3) Use only Table 3.1.1.4.B or Table 3.1.1.4.C, not both.

e4

Table 3.1.1.4.C (IP)
Permitted Substitutions for Airtight Dwelling Units⁽³⁾
Forming Part of Sentences 3.1.1.4.(1) and (3)

Required Compliance	Permitted Substitutions Airtightness Complies with Table 3.1.1.4.A ⁽¹⁾
Maximum Two Substitutions per <i>Dwelling Unit</i> ⁽²⁾	
Above grade continuous wall insulation R7.5 ci or R10 ci	Above grade continuous wall insulation R5 ci or R7.5 ci respectively
R22 or R24 insulation between studs in above grade walls with continuous insulation	R19 or R22 insulation respectively between studs in above grade walls with continuous insulation
<i>Basement</i> wall R20 + 12 ci, R20 + 10 ci or R20 ci	<i>Basement</i> wall R15 ci or R12 + 5 ci
Slab located more than 24 inches below grade and entire under slab insulation is R10 or R5	R0 , if the slab is unheated R5 min, if heated
R60 ceiling insulation with or without 10 inch high heel	R50 ceiling insulation
Column 1	2

Notes to Table 3.1.1.4.C (IP):

- (1) Where nominal R values are given, the use of corresponding "U" or "effective R" values are permitted.
 (2) Where the required airtightness is achieved, simultaneous substitution of two components listed in this Table is permitted.
 (3) Use only Table 3.1.1.4.B or Table 3.1.1.4.C, not both.

3.1.1.5. Elements Acting as a Thermal Bridge

(1) Except for a *foundation* wall, the insulated portion of a wall that incorporates wood stud framing elements that have a thermal resistance of less than RSI 0.90 shall be insulated to restrict heat flow through the studs by a material providing a thermal resistance at least equal to 25% of the thermal resistance required for the insulated portion of the assembly in Articles 3.1.1.2., 3.1.1.3. and 3.1.1.11.

(2) Except as provided in Sentence (3), the thermal resistance of the insulated portion of a *building* assembly in Articles 3.1.1.2. and 3.1.1.3. that incorporates metal framing elements, such as steel studs and steel joists, that act as thermal bridges to facilitate heat flow through the assembly, shall be 20% greater than the values shown in Tables 3.1.1.2.A, to 3.1.1.2. C and Tables 3.1.1.3.A to 3.1.1.3.C and Table 3.1.1.11., unless it can be shown that the heat flow is not greater than the heat flow through a wood frame assembly of the same thickness.

(3) Sentence (2) does not apply to *building* assemblies incorporating thermal bridges where the thermal bridges are insulated to restrict heat flow through the thermal bridges by a material providing a thermal resistance at least equal to 25% of the thermal resistance required for the insulated portion of the assembly in Articles 3.1.1.2., 3.1.1.3. and 3.1.1.11.

3.1.1.6. Log Wall Construction and Post, Beam and Plank Construction

(1) Except as provided in Sentences (2) and (3), log wall construction and post, beam and plank construction shall have a minimum thermal resistance of RSI 2.1 for the total assembly.

- (2) The thermal resistance value in Sentence (1) for the total wall assembly may be reduced to not less than RSI 1.61 if,
 (a) the thermal resistance of insulation for the exposed roof or ceiling required in selected compliance package is increased by an amount equivalent to the reduction permitted in this Sentence, and
 (b) for log walls, the logs have tongue-and-groove or splined joints.

- (3) Where milled log walls are installed, the thermal resistance value in Sentence (1) for the total wall assembly does not apply if,
 - (a) the mean thickness of each log is not less than 150 mm,
 - (b) the thermal resistance of insulation for the exposed roof or ceiling required in selected compliance package is increased by RSI 0.53, and
 - (c) the logs have tongue-and-groove or splined joints.
- (4) Where a log wall is constructed in accordance with Sentences (1) to (3), the log wall shall be deemed to comply with the requirements in Subsection 9.25.3. of Division B of the *Building Code*.

3.1.1.7. Insulation of Foundation Walls

- (1) *Foundation* walls enclosing heated space shall be insulated from the underside of the subfloor to not more than 200 mm above the finished floor level of the *basement*. (See Appendix A.)
- (2) The insulation required by Sentence (1) may be provided by a system installed,
 - (a) on the interior of the *foundation* wall,
 - (b) on the exterior face of the *foundation* wall, or
 - (c) partially on the interior and partially on the exterior, provided the thermal performance of the system is equivalent to that permitted in Clauses (a) or (b).
- (3) If a *foundation* wall is constructed of hollow masonry units, one or more of the following shall be used to control convection currents in the core spaces,
 - (a) filling the core spaces,
 - (b) at least one row of semi-solid blocks at or below *grade*, or
 - (c) other similar methods.
- (4) Masonry walls of hollow units that penetrate the ceiling shall be sealed at or near the ceiling adjacent to the roof space to prevent air within the voids from entering the *attic or roof space* by,
 - (a) capping with masonry units without voids, or
 - (b) installation of flashing material extending across the full width of the masonry.
- (5) Except as provided in Sentences (6) and (7), where a portion of a *basement* slab or a portion of a *basement* slab edge is the only part of the slab that is at the exterior ground level such as a walk-out *basement*, or within 600 mm of the exterior ground level, those portions shall have perimeter insulation extend not less than 600 mm below the slab level. (See Appendix A.)
- (6) Where the entire concrete slab is within 600 mm of the exterior ground level, the entire surface of the slab shall be insulated. (See Appendix A.)
- (7) Where a slab contains heating ducts, pipes, tubes or cables, the entire heated surface of the slab that is in contact with the ground shall be insulated.

3.1.1.8. Thermal Resistance Values for Roof Access Hatches and Eaves

- (1) Except as provided in Sentence (2), the thermal resistance values for insulation required by Articles 3.1.1.2., 3.1.1.3. and 3.1.1.11. for exposed ceilings with attic spaces are permitted to be reduced
 - (a) directly above access hatches, and
 - (b) near eaves to the extent made necessary by the roof slope and required ventilation clearances,except that the thermal insulation value at the location directly above access hatches and inner surfaces of exterior walls shall be not less than RSI 3.52.
- (2) Where 250 mm high heel is required near the eaves, the available space on the inner surface of the wall below the roof venting space shall be fully insulated.

3.1.1.9. Thermal Performance of Windows, Skylights and Sliding Glass Doors

- (1) Except as provided in Sentences (3) to (5), windows, skylights and sliding glass doors shall meet
- the required *overall coefficient of heat transfer* in Tables 3.1.1.2.A 3.1.1.2.B and 3.1.1.2.C and Tables 3.1.1.3.A, 3.1.1.3.B and 3.1.1.3. C and Table 3.1.1.11., or
 - the corresponding energy rating in Table 3.1.1.9.
- (2) The energy rating and the *overall coefficient of heat transfer* required for windows and sliding glass doors in a *residential occupancy* shall be determined in conformance with
- CAN/CSA-A440.2, “Fenestration Energy Performance”, or
 - NFRC 100, “Procedure for Determining Fenestration Product U-factors” and NFRC 200, “Procedure for Determining Fenestration Product Solar Heat Gain Coefficient and Visible Transmittance at Normal Incidence”.
- (3) A *basement* window that incorporates a *loadbearing* structural frame need not meet Sentence (1) provided that it has the following
- double glazed with a low-E coating,
 - inert gas-filled,
 - have an insulated spacer, and
 - if the frame is made from metal, the frame shall be thermally broken.
- (4) Glass blocks and decorative windows, including side lights, integrated glazing in doors, half-circle windows, leaded windows, transoms and other specialty glazing products, need not comply with Sentence (1) provided that the total area of such decorative glazing in the *building* does not exceed 1.85 m².
- (5) Windows and sliding glass doors need not meet the *overall coefficient of heat transfer* required by Sentence (1) where the window or sliding glass door necessitates a low solar heat gain coefficient due to its orientation and results in a U-Value greater than that permitted by Sentence (1), provided the overall thermal performance of all windows and sliding glass doors is maintained by improving the performance of other windows or sliding glass doors.

Table 3.1.1.9.
Maximum U-Values and Minimum Energy Ratings (ER) for Windows, Skylights and Sliding Glass Doors
 Forming Part of Sentence 3.1.1.9.(1)

Component	Maximum U-Values	Minimum Energy Ratings, (ER)
	U-Value, W/m ² •K (Btu/h•ft ² •°F)	ER
Skylights	2.8 (0.50)	—
Windows and Sliding Glass Doors	2.0 (0.35)	17
	1.8 (0.32)	21
	1.6 (0.28)	25
	1.4 (0.25)	29
	1.2 (0.21)	34
	1.0 (0.18)	38
Column 1	2	3

3.1.1.10. Minimum Thermal Resistance of Doors

- (1) Except as provided in Sentence (2) and except for doors in enclosed unheated vestibules and cold cellars, and except for glazed portions of doors, all doors that separate heated space from unheated space shall have a thermal resistance of not less than RSI 0.7 where a storm door is not provided.
- (2) One exterior door system, with a single or multiple leaf door, that does not comply with Sentence (1) is permitted for each *dwelling unit*.
- (3) All doors that separate heated space from unheated enclosed spaces shall have an insulated core and be installed with weatherstripping.

3.1.1.11. Additions to Existing Buildings

- (1) Except as provided in Sentences (2) and (3), an addition to an existing *building* shall comply with
 - (a) one of the applicable compliance packages in Article 3.1.1.2. or 3.1.1.3. in accordance with this Subsection, or
 - (b) Sentences 3.1.1.1.(7) to (9), except that the Tables referenced in Sentences 3.1.1.1.(7) and (8) are permitted to be substituted with Table 3.1.1.11.
(See Appendix A.)
- (2) For the purpose of Sentences 3.1.1.1.(7) to (9) and Subsection 3.1.2., the addition may be considered independently or in combination with the existing *building*, regardless of the thermal characteristics of the existing *building* envelope.
(See Appendix A.)
- (3) A one-storey sunroom addition to an existing *building* shall be deemed to be in compliance with Articles 3.1.1.2. and 3.1.1.3. and Subsection 3.1.2., provided that the *overall coefficient of heat transfer* of
 - (a) doors, windows and walls has a maximum U-Value of
 - (i) 1.4 if the *building* does not use *electric space heating*, and
 - (ii) 1.2 if the *building* uses *electric space heating*, and
 - (b) roofs and skylights has a maximum U-Value of 2.6.
(See Appendix A.)

Table 3.1.1.11. (SI)
Thermal Performance Requirements for Additions to Existing Buildings⁽³⁾
Forming Part of Sentence 3.1.1.11.(2)

Component	Thermal Values ⁽⁷⁾	Compliance Package		
		Zone 1	Zone 2	Electric Space Heating
		Less than 5000 Degree Days	5000 or more Degree Days	Zones 1 and 2
e4 Ceiling with Attic Space	Min. Nominal RSI ⁽¹⁾	10.56	10.56	10.56
	Max. U ⁽²⁾	0.096	0.096	0.096
	Min. Effective RSI ⁽²⁾	10.43	10.43	10.43
Ceiling Without Attic Space	Min. Nominal RSI ⁽¹⁾	5.46	5.46	5.46
	Max. U ⁽²⁾	0.205	0.205	0.205
	Min. Effective RSI ⁽²⁾	4.87	4.87	4.87
Exposed Floor	Min. Nominal RSI ⁽¹⁾	5.46	5.46	5.46
	Max. U ⁽³⁾	0.190	0.190	0.190
	Min. Effective RSI ⁽³⁾	5.25	5.25	5.25
Walls Above Grade	Min. Nominal RSI ⁽¹⁾	3.34 + 0.88 ci	3.87 + 1.32 ci	3.87 + 1.76 ci
	Max. U ⁽³⁾	0.280	0.238	0.215
	Min. Effective RSI ⁽³⁾	3.58	4.21	4.65
Basement Walls ⁽⁶⁾	Min. Nominal RSI ⁽¹⁾	3.52 ci	3.52 ci	3.52 ci
	Max. U ⁽⁴⁾	0.269	0.269	0.269
	Min. Effective RSI ⁽⁴⁾	3.72	3.72	3.72
Heated Slab or Slab ≤ 600 mm Below Grade	Min. Nominal RSI ⁽¹⁾	1.76	1.76	1.76
	Max. U ⁽⁴⁾	0.510	0.510	0.510
	Min. Effective RSI ⁽⁴⁾	1.96	1.96	1.96
Edge of Below Grade Slab ≤ 600 mm Below Grade	Min. Nominal RSI ⁽¹⁾	1.76	1.76	1.76
Windows and Sliding Glass Doors	Max. U ⁽⁵⁾	1.6	1.4	1.4
	Energy Rating	25	29	29
Column 1	2	3	4	5

Notes to Table 3.1.1.11. (SI):

- (1) The values listed are minimum Nominal RSI-Values for the thermal insulation component only.
- (2) U-Value and *effective RSI value* shall include entire ceiling assembly components, from interior air film to vented space air film above insulation.
- (3) U-Value and *effective RSI value* shall include entire exposed floor or above grade wall assembly components, from interior air film to exterior air film.
- (4) U-Value and *effective RSI value* shall include entire *basement* wall or slab assembly components and interior air film.
- (5) U-Value is the *overall coefficient of heat transfer* for a window assembly, sliding glass door assembly or skylight assembly expressed in W/(m²•K).
- (6) In the case of *basement* wall assemblies, where RSI 3.52 ci is required RSI 2.11 + 1.76 ci is permitted to be used or vice versa; or where RSI 2.11 + 0.88 ci is required, RSI 2.64 ci is permitted to be used or vice versa.
- (7) Nominal and *effective RSI values* are expressed in (m²•K)/W. U-Values are expressed in W/(m²•K).

Table 3.1.1.11. (IP)
Thermal Performance Requirements for Additions to Existing Buildings⁽³⁾
Forming Part of Sentence 3.1.1.11.(2)

Component	Thermal Values ⁽⁷⁾	Compliance Package		
		Zone 1	Zone 2	Electric Space Heating
		Less than 5000 Degree Days	5000 or more Degree Days	Zones 1 and 2
Ceiling with Attic Space	Min. Nominal R ⁽¹⁾	60	60	60
	Max. U ⁽²⁾	0.017	0.017	0.017
	Min. Effective R ⁽²⁾	59.22	59.22	59.22
Ceiling Without Attic Space	Min. Nominal R ⁽¹⁾	31	31	31
	Max. U ⁽²⁾	0.036	0.036	0.036
	Min. Effective R ⁽²⁾	27.65	27.65	27.65
Exposed Floor	Min. Nominal R ⁽¹⁾	31	31	31
	Max. U ⁽³⁾	0.034	0.034	0.034
	Min. Effective R ⁽³⁾	29.80	29.80	29.80
Walls Above Grade	Min. Nominal R ⁽¹⁾	19 + 5 ci	22 + 7.5 ci	22 + 10 ci
	Max. U ⁽³⁾	0.049	0.042	0.038
	Min. Effective R ⁽³⁾	20.32	23.90	26.40
Basement Walls ⁽⁶⁾	Min. Nominal R ⁽¹⁾	20 ci	20 ci	20 ci
	Max. U ⁽⁴⁾	0.047	0.047	0.047
	Min. Effective R ⁽⁴⁾	21.12	21.12	21.12
Heated Slab or Slab ≤ 600 mm Below Grade	Min. Nominal R ⁽¹⁾	10	10	10
	Max. U ⁽⁴⁾	0.090	0.090	0.090
	Min. Effective R ⁽⁴⁾	11.13	11.13	11.13
Edge of Below Grade Slab ≤ 600 mm Below Grade	Min. Nominal R ⁽¹⁾	10	10	10
Windows and Sliding Glass Doors	Max. U ⁽⁵⁾	0.28	0.25	0.25
	Energy Rating	25	29	29
Column 1	2	3	4	5

Notes to Table 3.1.1.11 (IP):

- (1) The values listed are minimum Nominal R values for the thermal insulation component only.
- (2) U-Value and effective R value shall include entire ceiling assembly components, from interior air film to vented space air film above insulation.
- (3) U-Value and effective R value shall include entire exposed floor or above grade wall assembly components, from interior air film to exterior air film.
- (4) U-Value and effective R value shall include entire *basement* wall or slab assembly components and interior air film.
- (5) U-Value is the *overall coefficient of heat transfer* for a window assembly, sliding glass door assembly or skylight assembly expressed in Btu/(h·ft²·F).
- (6) In the case of *basement* wall assemblies, where R20 ci is required R12 + 10 ci is permitted to be used or vice versa; or where R12 + 5 ci is required, R15 ci is permitted to be used or vice versa.
- (7) Nominal and effective R values are expressed in (h·ft²·F)/Btu. U-Values are expressed in Btu/(h·ft²·F).

3.1.1.12. Drain Water Heat Recovery

- (1) Except as provided in Sentence (2), a drain water heat recovery unit shall be installed in each *dwelling unit* to receive drain water from all showers or from at least two showers where there are two or more showers in the *dwelling unit*. (See Appendix A.)
- (2) Sentence (1) does not apply to *dwelling units* in which:
 - (a) there are no showers; or
 - (b) there are no storeys or crawl spaces beneath any of the showers in the *dwelling unit*.
- (3) Drain water heat recovery units shall conform to CSA B55.2, “Drain Water Heat Recovery Units”.
- (4) The minimum efficiency of a drain water heat recovery unit shall be determined in conformance with CSA B55.1, “Test Method for Measuring Efficiency and Pressure Loss of Drain Water Heat Recovery Units”.
- (5) The efficiency of a drain water heat recovery unit, when tested in accordance with Sentence (4), shall be not less than 42%.
- (6) A drain water heat recovery unit shall be installed
 - (a) in an upright position that does not diverge more than 5 degrees from the vertical,
 - (b) in a position such that the cold water inlet connection is at the bottom of the unit,
 - (c) downstream of a water softener where a water softener is installed, and
 - (d) in a *conditioned space* or on the warm side of the dewpoint of the wall assembly.

3.1.2. Performance Compliance

3.1.2.1. Required Performance Level (See Appendix A.)

- (1) The performance level shall be measured based on the simulated annual energy use of the *building*.
- (2) For the purpose of this Subsection, reference *building* means a *building* that is identical to the proposed *building*, except that it is designed to meet the requirements and performance level of an applicable compliance package in Subsection 3.1.1. on the basis of
 - (a) zone location,
 - (b) energy source, and
 - (c) equipment efficiency.
- (3) The simulated annual energy use of the proposed *building* shall not be greater than the simulated annual energy use of the reference *building*.
- (4) The simulated annual energy use of the proposed *building* and the reference *building* shall be calculated in accordance with Table 3.1.2.1.
- (5) For the purpose of calculations required in Sentence (4),
 - (a) the simulation software used shall be a recognized annual energy use simulation software,
 - (b) the climatic data used shall be the local climatic data,
 - (c) the equivalent domestic water loads, appliance loads and other plug-in loads shall be assumed for both the proposed *building* and the reference *building*, and
 - (d) the same software and climatic conditions shall be used for both the proposed *building* and the reference *buildings*.
- (6) Where the overall thermal performance of the proposed *building* envelope is less than the envelope performance of the compliance package that is compared against it, the reduction in the performance level of the *building* envelope shall not be more than 25%.
- (7) The annual energy use simulation of the reference *building* shall be in accordance with Subsection 3.1.1. of this Supplementary Standard, Part 12 and other applicable parts of the *Building Code*.

e4

Table 3.1.2.1.
Specification for the Reference and Proposed Building Design
Forming Part of Sentence 3.1.2.1.(4)

Building Component	Reference Building Design	Proposed Building Design
Building Envelope	<p>Dimensions and orientation: same as proposed design.</p> <p><i>Fenestration</i> to wall ratio: same as proposed up to 22%, (where $17\% < \text{ratio} \leq 22\%$, U-Value is required to be upgraded as per 3.1.1.1.(8)) where the proposed <i>fenestration</i> to wall ratio exceeds 22%, the <i>fenestration</i> area of the reference <i>building</i> shall be reduced proportionally along each exposure until the 22% is met.</p> <p>RSI Values or U-Values and ER values: as per applicable compliance package required in Subsection 3.1.1.</p>	As proposed (See Sentences 3.1.2.1.(5) to (8)).
Construction Type	<p>Above Grade:</p> <p>Wood Frame spacing: 406 mm o.c. for wall studs, 406 mm o.c. for exposed floors joists, roof joists, and roof rafters, and 610 mm o.c. for roof trusses.</p> <p>Below Grade: Concrete with interior insulation.</p>	As proposed.
Air Leakage Rate	<p>Detached dwelling: 3.0 ACH, NLA 2.12 cm²/m², or NLR 1.32 L/s/m²</p> <p>Attached dwellings: 3.5 ACH, NLA 2.27 cm²/m², or NLR 1.44 L/s/m²</p> <p>(See Appendix A).</p>	Same as reference, or tested air leakage rate, that is measured in accordance with Sentence 3.1.1.4.(2).
On-site Renewable Energy	None. ⁽¹⁾	As proposed.
Ventilation	HRV operating continuously at principle exhaust flow rate and with SRE as per applicable compliance package required in Subsection 3.1.1.	As proposed.
Drain Water Heat Recovery	Drain water heat recovery units as per Article 3.1.1.12.	As proposed.
Heating System and Service Water Heating	<p>Fuel or energy type: Same as proposed⁽²⁾</p> <p>Equipment: Furnace and water tank.</p> <p>Efficiency: As per applicable compliance package required in Subsection 3.1.1. Where it is not specified, as per applicable provincial regulations.</p>	As proposed.
Plumbing	Complies with Part 7 of the <i>Building Code</i> .	As proposed but must comply with Part 7 of the <i>Building Code</i> or exceed.
Cooling System, if proposed ⁽³⁾	<p>Energy type: Electric.</p> <p>Equipment: Same as proposed.</p> <p>Efficiency: As per applicable provincial regulations.</p>	As proposed.
Column 1	2	3

e4

Table 3.1.2.1. (Cont'd)
Specification for the Reference and Proposed Building Design
 Forming Part of Sentence 3.1.2.1.(4)

Building Component	Reference Building Design	Proposed Building Design
Operating Conditions / Default Values	Except as indicated in this Subsection and the <i>Building Code</i> , for the purpose of annual energy use simulations, the same operating conditions and default values shall be used for the reference <i>building</i> and the proposed <i>building</i> . ⁽⁴⁾	
All Components, Inputs for assemblies, workmanship, etc.	For both the reference <i>building</i> and the proposed <i>building</i> , input methodologies shall be the same and consistent with each other, e.g. use <ul style="list-style-type: none"> • Either user defined or build-up inputs for <i>building</i> envelope assemblies, • The same insulation installation quality; and • The same air tightness for the ductwork. 	
Internal gains, electrical loads, other components and characteristics that are not described in this Subsection and Subsection 3.1.1.	The same values or systems shall be used for both the reference <i>building</i> and the proposed <i>building</i> .	
Column 1	2	3

Notes to Table 3.1.2.1.:

- (1) Except where principle heating fuel is wood or wood products.
- (2) For the purpose of annual energy use simulations, where an air or water source heat pump, or an earth energy system is proposed, the fuel or energy source of the reference *building* system is permitted to be the same as the supplementary (back up) energy source of the proposed heat pump system.
- (3) Where cooling is proposed, annual energy use simulations shall include cooling system.
- (4) Operating conditions consistent with Section 4.6 of NRCan's EnerGuide Rating System Version 15.1 may be used.

3.1.3. Other Acceptable Compliance Methods

3.1.3.1. Other Acceptable Compliance Methods (See Appendix A.)

- (1) A *building* shall be deemed to be in compliance with the requirements of Subsection 3.1.1.
 - (a) Provided that the same performance level is achieved through the technical requirements of NRCan, "Energy Star for New Homes Standard Version 12.6." or,
 - (b) The *building* meets the NRCan, "2012 R2000 Standard".

Appendix A

Explanatory Material for SB-12

Chapter 1: General

1.3.2.1.(2) Defined Terms

Effective RSI Value and U-Value Calculations

Effective RSI values and U values are to be calculated in accordance with good practice. Some sample effective R value *calculations* are provided below. *Overall thermal transmittance* (U values) can be calculated by taking the inverse of *the* effective R value ($U=1/(\text{effective RSI value})$)

Information on the calculation of effective thermal resistance of opaque assemblies can also be found at the following NRCan website <http://www.nrcan.gc.ca/energy/efficiency/housing/new-homes/energy-star/14176> . The combined values for the stud and cavity insulation components used below are taken from the same website. Further details can be found under "Tables for Calculating Effective Thermal Resistance of Opaque Assemblies".

Sample effective RSI values:

e4 Ceiling with Attic Space - RSI Nominal 8.80	
Details	Effective RSI
Roof sheathing (above vented air space, therefore excluded from calculation)	0
Vented roof air space	0.03
RSI 6.69 (R38) nominal of blown in cellulose	6.69
Roof truss bottom chord dimensional lumber - 38 mm x 89 mm (2" x 4"), 610 mm (24") on-centre, RSI 2.11 (R12) nominal cavity fill between bottom chords	1.76
Polyethylene vapour retarder (negligible contribution to effective thermal resistance)	0
12.7 mm (1/2") gypsum board	0.08
Air film interior, ceiling	0.11
Total	8.67

Above Grade Wall - RSI Nominal 3.87 + 0.88 ci (vinyl)	
Details	Effective RSI
Air film exterior	0.03
Exterior Finish* - Siding - vinyl, hollow-backed	0.11
RSI 0.88 (R5) XPS sheathing	0.88
Stud dimensional lumber – 38 mm x 140 mm (2" x 6") 406 mm (16") on-centre RSI 3.87 (R22) nominal cavity fill between studs	2.55
Polyethylene vapour retarder (negligible contribution to effective thermal resistance)	0
12.7 mm (1/2") gypsum board	0.08
Air film interior	0.12
Total	3.77

* Where exterior finish is brick, brick and air gap values are permitted to be substituted for siding.

Basement Wall* - RSI Nominal 3.52 ci	
Details	Effective RSI
Concrete foundation wall, 200 mm (8")	0.08
RSI 3.52 (R20) blanket	3.52
Air film interior	0.12
Total	3.72

* Where the basement is finished or drywall installed, drywall and other components that contribute to *effective RSI value* will be added.

Below Grade Slab - RSI Nominal 1.76	
Details	Effective RSI
Air film interior	0.16
Concrete slab, 100 mm (4")	0.04
RSI 1.76 (R10) XPS sheathing	1.76
Total	1.96

Exposed Floor - RSI Nominal 5.46 (carpet)	
Details	Effective RSI
Air film exterior	0.03
12.7 mm (1/2") gypsum board	0.08
Dimensional lumber joist - 38 mm x 235 mm (2" x 10"), 406 mm (16") on-centre, RSI 5.46 (R31) nominal cavity fill	4.46
Polyethylene vapour retarder (negligible contribution to effective thermal resistance)	0
15.5 mm (5/8") OSB	0.16
Carpet and underpad	0.36
Air film interior	0.16
Total	5.25

Continuous Insulation (ci)

Continuous insulation (ci) is intended to minimize the thermal bridges in an assembly. It is generally uninterrupted across all structural members. Exceptions to this include fasteners and service openings. Insulation may generally be installed on the interior or the exterior, or may be integral to any opaque surface of the *building* envelope. It may generally be made of various material such as board, blanket, sprayed or other types of insulation. Compressions such as blanket fasteners are permitted.

A-Table 1.4.1.2. National Fenestration Rating Council.

Name	Address	Contact
NFRC	National Fenestration Rating Council 6305 Ivy Lane, Suite 140 Greenbelt, MD 20770, USA	ph: 301-589-1776 fax: 301-589-3884 web site: www.nfrc.org
Column 1	2	3

Chapter 2: Acceptable Solutions for Achieving Energy Efficiency Compliance Before January 1, 2017.

A-2.1.1. Compliance Packages.

Individual components of compliance packages found in Tables 2.1.1.2.A, 2.1.1.2.B and 2.1.1.2.C and Tables 2.1.1.3.A, 2.1.1.3.B and 2.1.1.3.C are not permitted to be mixed with similar components of other compliance packages either found within the same Table or similar components of compliance packages found in other Tables.

A-2.1.1.1.(3) Mechanical Equipment.

Compliance package tables referred to in this Sentence contain energy efficiency requirements for some or all mechanical equipment. Where a compliance package includes an energy efficiency level for space heating equipment, domestic water heater or heat or energy recovery ventilator, conformance with the package can only be achieved if the *building* is equipped with the mechanical equipment specified in the compliance package.

A-2.1.1.1.(7), (8) and (10) Fenestration to Wall Ratio.

When the *fenestration* to wall ratio is calculated, all *fenestration* areas and the entire peripheral wall above grade is included. The peripheral wall area includes floor rim board areas and all above grade wall areas. It is essentially the sum of the above grade walls that separate conditioned spaces from unconditioned spaces, and adjacent units. In the case of an attached

garage, the walls that are common with the house and the garage are also included in the wall area calculations. For attached homes, the above grade portions of the walls that are common to other conditioned units are also included in the wall area. The *fenestration* area is based on the rough structural opening provided for windows, skylights, sliding glass doors, and for glazed portions in doors. For A-frame structures with steeply inclined roofs that also act as walls, the roof portion that serves as the interior wall area can be considered as the wall area in calculating the *fenestration* to wall ratio.

A-2.1.1.2.(6)(a), (8)(a), and (9)(a) RSI Reduction of Above Grade Walls in Conjunction with Upgrading U-Value of Glazing Zone 1.

Where the above grade wall insulation is permitted to be reduced to RSI 3.52, one of the required compensating measures is to upgrade the window U-Value in accordance with Clauses 2.1.1.1.(8)(a) to (c). This upgrade is independent of the glazing upgrade that may be required due to a *fenestration* ratio that is higher than 17%. In cases where the above grade insulation is reduced to RSI 3.52 and compensated for with a *fenestration* upgrade, and the *building* has more than 17% *fenestration*, the glazing would be required to be upgraded a second time.

A-2.1.1.3.(6)(a) and (7)(a) RSI Reduction of Above Grade Walls in Conjunction with Upgrading U-Value of Glazing - Zone 2.

Where the above grade wall insulation is permitted to be reduced to RSI 3.52, one of the required compensating measures is to upgrade the window U-Value in accordance with Clauses 2.1.1.1.(8)(a) to (c). This upgrade is independent of the glazing upgrade that may be required due to a *fenestration* ratio that is higher than 17%. In cases where the above grade insulation is reduced to RSI 3.52 and compensated for with a *fenestration* upgrade, and the *building* has more than 17% *fenestration*, the glazing would be required to be upgraded a second time.

A-2.1.1.6.(1) Permitted Basement Insulation Gap.

The provision refers to the gap between basement insulation and the floor level that might be left at the bottom of a foundation wall. Insulation can be extended from the underside of the subfloor to the floor level of the basement, or a gap may be left provided that the gap is not more than 200 mm when measured from floor level to where the insulation is terminated.

A-2.1.1.6.(5) and (6) Slab Insulation.

Except heated slabs and except where specifically required in a compliance package, the entire surface of the slab is only required to be insulated when the entire concrete slab is located completely within 600 mm of the exterior ground level. A typical example would be a slab on ground construction without a basement. If a slab is located partially at the exterior ground level (i.e. a walkout basement) or partially within 600 mm of the exterior surface, then only those sections are required to be insulated with perimeter insulation. The perimeter insulation could be horizontal or vertical. If the entire surface of the slab is insulated, or the perimeter insulation is horizontal, in both cases vertical insulation would not be mandatory.

Where a slab of a house is completely or partially within 600 mm of the exterior ground level, either the entire surface of the slab or the perimeter of the slab is required to be insulated but not at both locations.

A-2.1.1.10.(1) Additions to Existing Houses.

In Clause 2.1.1.10.(1)(a), the design and *construction* of an addition to an existing house can conform to the minimum *building* envelope and mechanical equipment requirements where an applicable compliance package is selected from Article 2.1.1.2. or 2.1.1.3.

Alternatively, Clause 2.1.1.10.(1)(b) provides a simpler approach and permits an addition to an existing *building* to comply with the appropriate column in Table 2.1.1.10. since the design and *construction* of an existing *building* is unlikely to be determined and matched against an applicable compliance package from Article 2.1.1.2. or 2.1.1.3. However, the addition is required to comply with Sentences 2.1.1.1.(7) to (10). Glazing upgrade of the addition is required if it falls within the scope of Sentence 2.1.1.1.(8). Table 2.1.1.10. further exempts both an addition and an existing *building* from conforming to minimum efficiency requirements for HRV's, domestic water heaters and space heating equipment required in Article 2.1.1.2. or 2.1.1.3. This would permit existing mechanical equipment to serve the entire *building* provided that it has the necessary capacity.

A-2.1.1.10.(2) Treatment of Additions.

Where the *fenestration* to wall ratio of an addition is calculated or the annual energy use of an addition is modeled for the purpose of demonstrating compliance, calculations can be done for only the addition or for the entire house including the existing part of the house. Regardless, the thermal characteristics of the existing *building*, existing window and wall areas can be used in the *fenestration* ratio calculations. Similarly, in the case of modeling, existing *building* components that have not been altered can be used as they are for the reference house and for the proposed design.

A-2.1.1.10.(3) Sunroom Additions to Existing Houses.

A sunroom addition to an existing house referred in this Sentence applies to a one-storey structure built substantially with wall/roof *fenestration* and glass doors but which sometimes contain unglazed low wall panels that support wall glazing above it. Since the glazing percentage of sunrooms exceeds the limits permitted for compliance packages in Articles 2.1.1.2. and 2.1.1.3. and performance compliance methods may not be possible, these sunrooms are exempt from compliance package requirements, provided that the thermal performance of the glazing is enhanced further than what is required for non-sunroom additions.

The maximum U-Values for doors, sliding glass doors, wall glazing and supporting wall panels for sunroom additions in Clause 2.1.1.10.(3)(a) have been derived from the maximum U-Values for window and sliding glass doors in additions to existing *buildings* in Table 2.1.1.10. and then upgraded in accordance with Sentence 2.1.1.1.(8).

The maximum U-Value of 2.6 for roofs and skylights for sunroom additions in Clause 2.1.1.10.(3)(b) has been derived from upgrading the maximum U-Value of 2.8 for skylights in additions to existing *buildings* in Table 2.1.1.10. consistent with the methodology used in Sentence 2.1.1.1.(8).

A-2.1.1.11.(4)(a) Drain Water Heat Recovery Units for Showers.

For the purpose of the prescriptive trade off provisions in Subsection 2.1.1., the term “all showers” includes the case where there is only one shower in a dwelling unit. If there is only one shower, that shower is required to be connected to a drain water heat recovery unit. Where there are two or more showers, drain water from at least two showers are required to be connected to a single drain water heat recovery unit or to two individual drain water heat recovery units.

A-2.1.2.1. Application of Performance Compliance Path.

This Article requires two annual energy use simulations. These simulations compare the simulated annual energy use of the proposed *building* with the simulated annual energy use of an applicable compliance package. The simulated annual energy use of the proposed *building* cannot exceed the simulated annual energy use of an applicable compliance package.

Where a performance compliance path is selected, it is the intent of Sentence 2.1.2.1.(2) that the performance level of the compliance package takes into account the requirements listed in Subsection 2.1.1. that are applicable to that compliance package. Similarly, the annual energy use calculation for a compliance package referenced in Clause 2.1.2.1.(3)(b) shall take into account the requirements listed in Subsection 2.1.1. that are applicable to that compliance package.

For the purpose of calculating the annual energy use of a proposed design and a design based on a selected compliance package, the following software may be used:

- HOT2000 version 9.34c or later versions
- Other software referenced by the EnerGuide Rating System
- Passive house software such as
 - WUFI Passive
 - Passive House Planning Package
- RESNET accredited Home Energy Rating System (HERS) software, such as:
 - OptiMiser
 - EnergyGauge
 - EnergyInsights
 - REM/Rate

A-2.1.3.1. Other Acceptable Compliance Methods.

Compliance with the technical requirements of the Energy Star Program may be achieved using either the prescriptive path or the performance path required by NRCan, “Energy Star for New Homes: Technical Specifications – Ontario”.

Clause 2.1.1.1 of NRCan, “Energy Star for New Homes: Technical Specifications – Ontario” allows the designer to use an NRCan-approved compliance option described in NRCan, “Energy Star for New Homes: Compliance Options” (Ontario).

Only the technical provisions contained in NRCan, “Energy Star for New Homes: Technical Specifications – Ontario” and other Energy Star documents it references are mandatory under this Supplementary Standard. However, in addition to the technical requirements, the administrative requirements of the Energy Star documents may be used to demonstrate compliance with Sentence 2.1.3.1.(1) by obtaining an Energy Star label for the *building*.

Chapter 3: Acceptable Solutions for Achieving Energy Efficiency Compliance After December 31, 2016.

A-3.1.1. Compliance Packages.

Individual components of compliance packages found in Tables 3.1.1.2.A to 3.1.1.2.C and Tables 3.1.1.3.A to 3.1.1.3.C are not permitted to be mixed with similar components of other compliance packages either found within the same Table or similar components of compliance packages found in other Tables.

A-3.1.1.1.(3) Mechanical Equipment.

Compliance package tables referred to in this Sentence contain energy efficiency requirements for some or all mechanical equipment. Where a compliance package includes an energy efficiency level for space heating equipment, domestic water heater or heat or energy recovery ventilator, conformance with the package can only be achieved if the *building* is equipped with the mechanical equipment specified in the compliance package.

A-3.1.1.1.(7), (8) and (9) Fenestration to Wall Ratio.

When the *fenestration* to wall ratio is calculated, all *fenestration* areas and the entire peripheral wall above grade is included. The peripheral wall area includes floor rim board areas and all above grade wall areas. It is essentially the sum of the above grade walls that separate conditioned spaces from unconditioned spaces, and adjacent units. In the case of an attached garage, the walls that are common with the house and the garage are also included in the wall area calculations. For attached homes, the above grade portions of the walls that are common to other conditioned units are also included in the wall area. The *fenestration* area is based on the rough structural opening provided for windows, skylights, sliding glass doors, and for glazed portions in doors. For A-frame structures with steeply inclined roofs that also act as walls, the roof portion that serves as the interior wall area can be considered as the wall area in calculating the *fenestration* to wall ratio.

Where the window performance needs to be upgraded in accordance with Sentence 3.1.1.1.(8), upgrading can be done based on ER values in conjunction with Table 3.1.1.9.

A-3.1.1.1. (16) Heat or Energy Recovery Ventilators.

Heat or energy recovery ventilators are required regardless of the type of heating system and not restricted to forced air heating systems only.

A-3.1.1.2. (5) and (6) ICF Walls.

The use of ICF walls are not limited to the packages identified in these Sentences. Where U value or *effective RSI value* of a ICF wall assembly is the same or better than the U value or *effective RSI value* required for a wall assembly in any of the Tables, the ICF wall can be used in lieu of that assembly.

A-3.1.1.3. (5) and (6) ICF Walls.

The use of ICF walls are not limited to the packages identified in these Sentences. Where U value or *effective RSI value* of a ICF wall assembly is the same or better than the U value or *effective RSI value* required for a wall assembly in any of the Tables, the ICF wall can be used in lieu of that assembly.

A-3.1.1.4. Airtightness.

This provision is a voluntary provision. It only applies if credit for airtightness is claimed. Credit for air tightness allows the designer to substitute the requirements of compliance packages as set out in Table 3.1.1.4.B or 3.1.1.4.C. Neither the air leakage test nor compliance with airtightness targets given in Table 3.1.1.4.A are required, unless credit for airtightness is claimed. Table 3.1.1.4.A provides airtightness targets in three different metrics; ACH, NLA, NLR. Where credit for substitution is claimed, any one of these metrics can be used; the *building* need not meet all targets in different metrics.

A-3.1.1.7.(1) Permitted Basement Insulation Gap.

The provision refers to the gap between basement insulation and the floor level that might be left at the bottom of a foundation wall. Insulation can be extended from the underside of the subfloor to the floor level of the basement, or a gap may be left provided that the gap is not more than 200 mm when measured from floor level to where the insulation is terminated.

A-3.1.1.7.(5) and (6) Slab Insulation.

Except heated slabs and except where specifically required in a compliance package, the entire surface of the slab is only required to be insulated when the entire concrete slab is located completely within 600 mm of the exterior ground level. A typical example would be a slab on ground construction without a basement. If a slab is located partially at the exterior ground level (i.e. a walkout basement) or partially within 600 mm of the exterior surface, then only those sections are required to be insulated with perimeter insulation. The perimeter insulation could be horizontal or vertical. If the entire surface of the slab is insulated, or the perimeter insulation is horizontal, in both cases vertical insulation would not be mandatory.

A-3.1.1.11.(1) Additions to Existing Houses.

In Clause 3.1.1.11.(1)(a), the design and *construction* of an addition to an existing house can conform to the minimum *building* envelope and mechanical equipment requirements where an applicable compliance package is selected from Article 3.1.1.2. or 3.1.1.3.

Alternatively, Clause 3.1.1.11.(1)(b) provides a simpler approach and permits an addition to an existing *building* to comply with the appropriate column in Table 3.1.1.11. since the design and *construction* of an existing *building* is unlikely to be determined and matched against an applicable compliance package from Article 3.1.1.2. or 3.1.1.3. However, the addition is required to comply with Sentences 3.1.1.1.(7) to (10). Glazing upgrade of the addition is required if it falls within the scope of Sentence 3.1.1.1.(8). Table 3.1.1.11. further exempts both an addition and an existing *building* from conforming to minimum efficiency requirements for HRV's, domestic water heaters and space heating equipment required in Article 3.1.1.2. or 3.1.1.3. This would permit existing mechanical equipment to serve the entire *building* provided that it has the necessary capacity.

A-3.1.1.11.(2) Treatment of Additions.

Where the *fenestration* to wall ratio of an addition is calculated or the annual energy use of an addition is modeled for the purpose of demonstrating compliance, calculations can be done for only the addition or the for entire house including the existing part of the house. Regardless, the thermal characteristics of the existing *building*, existing window and wall areas can be used in the *fenestration* ratio calculations. Similarly, in the case of modeling, existing *building* components that have not been altered can be used as they are for the reference house and for the proposed design.

A-3.1.1.11.(3) Sunroom Additions to Existing Houses.

A sunroom addition to an existing house referred in this Sentence applies to a one-storey structure built substantially with wall/roof *fenestration* and glass doors but which sometimes contain unglazed low wall panels that support wall glazing above it. Since the glazing percentage of sunrooms exceeds the limits permitted for compliance packages in Articles 3.1.1.2. and 3.1.1.3. and performance compliance methods may not be possible, these sunrooms are exempt from compliance package requirements, provided that the thermal performance of the glazing is enhanced further than what is required for non-sunroom additions.

The maximum U-Values for doors, sliding glass doors, wall glazing and supporting wall panels for sunroom additions in Clause 3.1.1.11.(3)(a) have been derived from the maximum U-Values for window and sliding glass doors in additions to existing *buildings* in Table 3.1.1.11. and then upgraded in accordance with Sentence 3.1.1.1.(8).

The maximum U-Value of 2.6 for roofs and skylights for sunroom additions in Clause 3.1.1.11.(3)(b) has been derived from upgrading the maximum U-Value of 2.8 for skylights in additions to existing *buildings* in Table 3.1.1.11. consistent with the methodology used in Sentence 3.1.1.1.(8).

A-3.1.1.12.(1) Shower Drainage Installation.

The term “all showers” includes the case where there is only one shower in a dwelling unit. If there is only one shower, that shower is required to be connected to a drain water heat recovery unit. Where there are two or more showers, drain water from at least two showers are required to be connected to a single drain water heat recovery unit or to two individual drain water heat recovery units.

A-3.1.2.1. Application of Performance Compliance Path.

This Article requires two annual energy use simulations. These simulations compare the simulated annual energy use of the proposed *building* with the simulated annual energy use of an applicable compliance package. The simulated annual energy use of the proposed *building* cannot exceed the simulated annual energy use of an applicable compliance package.

Where a performance compliance path is selected, it is the intent of Sentence 3.1.2.1.(2) that the performance level of the compliance package takes into account the requirements listed in Subsection 3.1.1. that are applicable to that compliance package. Similarly, the annual energy use calculation for a compliance package referenced in Sentence 3.1.2.1.(3) shall take into account the requirements listed in Subsection 3.1.1. that are applicable to that compliance package. In addition to Subsection 3.1.2., the proposed *building* is still required to meet Part 12 and other applicable parts of the code.

The air leakage rates in Table 3.1.2.1. are not requirements. The Table is not intended to require or suggest that the *building* meet those airtightness targets. They are provided only as default or reference values for the purpose of annual energy simulations, should the builder/owner decide to perform such simulations. They are given in three different metrics; ACH, NLA, NLR. Any of them can be used. They can be used as a default values for both a reference and proposed *building* or, where an air leakage test is conducted and credit for airtightness is claimed, the airtightness values in Table 3.1.2.1. can be used for the reference *building* and the actual leakage rates obtained from the air leakage test can be used as inputs for the proposed *building*.

Annual Energy Use Software: For the purpose of calculating the annual energy use of a proposed design and a design based on a selected compliance package, the following software may be used:

- HOT2000 version 10.51 or later versions
- other software referenced by the EnerGuide Rating System
- Passive house software such as
 - WUFI Passive
 - Passive House Planning Package
- RESNET accredited Home Energy Rating System (HERS) software, such as:
 - ICF International Beacon Residential Version 2-80-3
 - Ekotrope, HERS Module v2.0
 - EnergyGauge® USA Version 5.0
 - REM/Rate v14.6.2

Operating Conditions:

The following operation conditions may be used:

(Courtesy of NRCan- Section 4.6 of NRCan's EnerGuide Rating System Version 15.2)

4.6. Operating conditions

4.6.1. General

The EnerGuide Rating System applies two sets of operating conditions to provide EnerGuide Rating System services: standard operating conditions and household operating conditions.

Standard operating conditions are used as the basis for the calculation of the EnerGuide rating in order to provide an estimate of the home's energy performance independent of occupant behaviour. Houses that reach a zero rating have access to reduced operating conditions for their rating calculations.

Optionally provided by homeowners, household operating conditions are intended to provide customized operating conditions in order to generate an estimated annual energy use based on actual occupancy.

The rated annual energy consumption of a house is based on a number of standard assumptions as specified in **section 4.6.3**.

4.6.2. Standard operating conditions

4.6.2.1. Number of occupants

The EnerGuide rating is calculated assuming an occupant load of two adults and one child at home 50% of the time.

4.6.2.2. Temperature set points for space heating and cooling

The EnerGuide rating is calculated assuming standard thermostat settings (set points) for space heating and cooling as per **Table 2**.

Table 2 - Temperature set points

Area of house	Type of set point	Temperature
Main and upper floors	heating daytime (16 hours)	21°C (70°F)
	heating nighttime (8 hours)	18°C (64°F)
	cooling	25°C (77°F) if air conditioning present
Basement / walkout	heating	19°C (66°F)
	cooling	25°C (77°F) if air conditioning ducted to basement
Heated crawl space	heating	15°C (59°F)

Notes to Table 2:

- (1) A constant weighted average of 20 degrees Celsius is used to simulate the effect of the heating setback temperature.
- (2) Air conditioning can include heat pump space cooling systems.
- (3) If air conditioning is not ducted to the basement, the approved compliance software will allow the basement temperature to vary.

4.6.2.3. Hot water load

The EnerGuide rating is calculated assuming that the occupants collectively use approximately 190 litres (50 U.S. gal) of hot water per day (for showers, clothes washing, dishwashing and faucets) and that the water is heated to 55°C (131°F). Shower temperature is held constant at 41°C (106°F) leading to some variability in the shower hot water load due to variations in regional cold water inlet temperatures. The shower hot water load ranges from 89 L/day (24 U.S. gal/day) in the warmest region to 100 L/day (26 U.S. gal/day) in the coldest. The 97 L/day (26 U.S. gal/day) of hot water usage applied to activities other than showering is constant across all weather locations. In total, the hot water usage will range from 178 L/day (47 U.S. gal/day) to 199 L/day (53 U.S. gal/day).

4.6.2.4. Electrical base loads

The EnerGuide rating is calculated assuming that a standard amount of electricity (electrical base loads) is used as defined in **Table 3** and **Table 4**.

It is always assumed that the house has an electric range and electric clothes dryer. It is also assumed that the clothes dryer exhausts to the outside and operates at a flow rate of 38 L/s (158 cfm), 45 minutes a day, 365 days per year.

Table 3 - Standard electrical base loads

Electrical load	Standard value (kWh/day)
Interior lighting	2.6
Appliances (refer to Table 4)	6.3
Other electrical	9.7
Exterior use (exterior lighting and miscellaneous outdoor use)	0.9
Daily total	19.5
Annual total	25.6 GJ/year
Electrical load	Standard value (kWh/day)

Table 4 - Standard appliance loads

Appliance	Standard value (kWh/yr)
Refrigerator	639
Electric range	565
Clothes washer	148
Dishwasher	260
Clothes dryer	687
Annual total for above 5 appliances	2299
Daily total for above 5 appliances	6.3 kWh/day

Notes to Table 4:

- (1) Standard appliance ratings assume four occupants while the EnerGuide Rating System for homes assumes three occupants. Therefore, the loads for clothes washers and clothes dryers have been reduced by 25% to remain consistent with the rating system standard operating conditions.
- (2) Freezer and microwave electrical consumptions are included in the "Other electrical" category.

4.6.2.5. Reduced operating conditions for zero-rated homes

For homes with superior energy performance, there is provision for reducing some of the standard operating conditions. These reduced operating conditions are considered to be a variation of the standard operating conditions. To be eligible for these reductions, the builder or homeowner must provide the energy advisor with proof that the required conditions, as specified below, are met and the EnerGuide rating for the house must be zero when modelled with the reduced values.

a) Allowable hot water reductions

Zero-rated homes may reduce their hot water load by the specified amount for each of the conditions they meet in **Table 5**. The four categories may be applied on an individual basis.

Table 5 - Allowable hot water reductions for zero-rated homes

Category	Specification	Approximate reduction L/day (U.S. gal/day)
Low-flow showerheads	7.6 L/min (2.0 U.S. gpm) or less	19 (5.0)
Low-flow bathroom faucets	5.7 L/min (1.5 U.S. gpm) or less	10 (2.6)
Clothes washer	ENERGY STAR certified	18 (4.8)
Dishwasher	ENERGY STAR certified	3 (0.8)
Approximate total potential reduction		50 (13.2)

Notes to Table 5:

- (1) Showerhead water reductions are calculated by the approved compliance software based on incoming water temperature, flow rate and a shower length of seven minutes. Therefore, the 19 L/day (5.0 U.S. gal/day) for showerheads and the total potential reduction are approximate numbers.

b) Allowable electrical base loads reductions

Zero-rated homes may reduce their electrical base loads for interior lighting and appliances as detailed in **Table 6**. The “Other electrical” and “Exterior use” categories may not be reduced.

Table 6 - Allowable electrical base loads for zero-rated homes

Category	Conditions	Allowable reduced base load
Interior Lighting	25% to 75% of fixtures with compact fluorescent light bulbs or light emitting diodes	1.6 kWh/day
	> 75% of fixtures with compact fluorescent light bulbs or light emitting diodes	0.6 kWh/day
Appliances	The actual EnerGuide appliance rating must be lower than the following standard values: <ul style="list-style-type: none"> Refrigerator: 639 kWh/yr Electric range: 565 kWh/yr Dishwasher: 260 kWh/yr Clothes washer: 197 kWh/yr Clothes dryer: 916 kWh/yr 	Use the actual EnerGuide appliance rating If an appliance is not present, default values must be used

Notes to Table 6:

- (1) Gas appliances will not be considered as a reduction to electrical base loads.

A-3.1.3.1. Other Acceptable Compliance Methods.

Compliance with this Supplementary Standard may be achieved using either the prescriptive path or the performance path required by NRCan, “Energy Star for New Homes Standard Version 12.6”, provided that the same performance level is achieved through its technical requirements. Compliance with the technical requirements of NRCan, “2012 R-2000 Standard” also achieves compliance with this Supplementary Standard.

Only the technical provisions contained in NRCan, “2012 R-2000 Standard” or NRCan, “Energy Star for New Homes Standard Version 12.6” and other Energy Star documents it references are mandatory under this Supplementary Standard. However, in addition to the technical requirements, the administrative requirements of the Energy Star or R-2000 documents may be used to demonstrate compliance with Sentence 3.1.3.1.(1) by obtaining an Energy Star or R-2000 label for the *building*.

MMAH Supplementary Standard SB-13

Glass in Guards

September 14, 2012

COMMENCEMENT

MMAH Supplementary Standard SB-13 comes into force on the 1st day of January, 2014.

© Copyright

© Copyright Queen's Printer for Ontario 2012

All rights reserved.

Questions regarding copyright, including reproduction and distribution, may be directed to the Director,
Building and Development Branch of the Ministry of Municipal Affairs and Housing.

SB-13 Glass in Guards

1.1.	General	
1.1.1.	Application of Supplementary Standard SB-13	3
1.2.	Terms and Abbreviations	
1.2.1.	Definitions of Words and Phrases.....	3
1.2.2.	Symbols and Other Abbreviations	3
1.3.	Referenced Documents and Organizations	
1.3.1.	Referenced Documents	3
2.1.	Glass	
2.1.1.	Selection of Glass in a Guard	4
3.1.	Structural Design	
3.1.1.	Design Requirements	5

Introduction

The prescriptive requirements for the design and construction of glass in guards in this Supplementary Standard are intended to reduce the probability of:

- (a) breakage of glass panels; and
- (b) injury to persons in the vicinity of a building as a result of falling broken glass.

Ontario's Building Code is written in an objective-based format to facilitate and encourage the use of alternative solutions to the prescriptive solutions contained in Division B of the Building Code and the standards referenced by the Code. Therefore, it is expected that the prescriptive-based solutions in this Supplementary Standard will form the benchmark for evaluating alternative solutions, including matrix-based risk assessment solutions. This approach will continue to allow for some flexibility and design choice for architects, engineers, developers, and the construction industry.

This Supplementary Standard is referenced by Sentence 3.1.20.1.(1) of Division B of the Building Code.

Section 1.1. General

1.1.1. Application of Supplementary Standard SB-13

1.1.1.1. Application

- (1) Except as provided in Sentence (2), this Supplementary Standard applies to glass used in interior and exterior *guards* in *buildings* described in Sentence 1.1.2.2.(1) of Division A of the *Building Code*.
- (2) This Supplementary Standard does not apply to glass used in
 - (a) *guards* at locations referred to in Sentence 3.3.4.7.(1) of Division B of the *Building Code*, or
 - (b) walls that act as *guards*.

Section 1.2. Terms and Abbreviations

1.2.1. Definitions of Words and Phrases

1.2.1.1. Non-defined Terms

- (1) Definitions of words and phrases used in this Supplementary Standard that are not included in the list of definitions in Articles 1.4.1.2. and 1.4.1.3. of Division A of the *Building Code* and are not defined in another provision of the Code shall have the meanings that are commonly assigned to them in the context in which they are used, taking into account the specialized use of terms by the various trades and professions to which the terminology applies.

1.2.1.2. Defined Terms

- (1) Each of the words and terms in italics in this Supplementary Standard has the same meaning as in Subsection 1(1) of the *Building Code Act, 1992* or Clause 1.4.1.2.(1)(b) of Division A of the *Building Code*.

1.2.2. Symbols and Other Abbreviations

1.2.2.1. Symbols and Other Abbreviations

- (1) Where used in this Supplementary Standard, a symbol or abbreviation listed in Column 1 of Table 1.4.2.1. of Division A of the *Building Code* shall have the meaning listed opposite it in Column 2.

Section 1.3. Referenced Documents and Organizations

1.3.1. Referenced Documents

1.3.1.1. Effective Date

- (1) Unless otherwise specified in this Supplementary Standard, the documents referenced in this Supplementary Standard shall include all amendments, revisions and supplements effective to September 7, 2012.

1.3.1.2. Applicable Editions

(1) Where documents are referenced in this Supplementary Standard, they shall be the editions designated in Column 2 of Table 1.3.1.2.

Table 1.3.1.2.
Referenced Documents
Forming Part of Sentence 1.3.1.2.(1)

Issuing Agency	Document Number	Title of Document	Supplementary Standard Reference
DIN	DIN EN 14179-1 September 2005	Heat Soaked Thermally Toughened Soda Lime Silicate Safety Glass	2.1.1.3.(1)
Column 1	2	3	4

Notes to Table 1.3.1.2.:

(1) DIN refers to the "Deutsches Institut für Normung e. V.". In English, DIN means the German Institute for Standardization. (See Appendix A.)

Section 2.1. Glass

2.1.1. Selection of Glass in a Guard

2.1.1.1. Safety Glass

- (1) Glass other than safety glass shall not be used in a *guard*.
- (2) Glass in a *guard* shall conform to Table 2.1.1.1.

Table 2.1.1.1.
Selection of Glass in a Guard
Forming Part of Sentence 2.1.1.1.(2)

Location of Glass in a <i>Guard</i>	Type of Glass Required
Glass located beyond the edge of a floor or within 50 mm of the edge of a floor	Heat strengthened laminated glass
Glass located more than 50 mm inward from the edge of a floor	Heat strengthened laminated glass
	Heat soaked tempered glass
Glass located more than 150 mm inward from the edge of a floor	Heat strengthened laminated glass
	Heat soaked tempered glass
	Tempered glass not more than 6 mm thick
Column 1	2

2.1.1.2. Laminated Glass

(1) Laminated glass shall be designed, fabricated, and installed so that, in the event of failure of the glass, the glass does not dislodge from the support framing.

2.1.1.3. Heat Soaked Tempered Glass

(1) Heat soaked tempered glass shall conform to DIN EN 14179-1, "Heat Soaked Thermally Toughened Soda Lime Silicate Safety Glass". (See Appendix A.)

Section 3.1. Structural Design

3.1.1. Design Requirements

3.1.1.1. Structural Design

- (1) Glass in a *guard* shall conform to the requirements of Part 4 of Division B of the *Building Code*. (See Appendix A.)
- (2) Glass in a *guard* shall not be in direct contact with any metal or similar hard elements forming part of the *guard* or supporting structure.
- (3) Sufficient allowances shall be incorporated for glass in a *guard* to permit,
 - (a) deflection and movement under loads, and
 - (b) expansion and contraction due to temperature changes.

Appendix A

Explanatory Material for SB-13

Appendix A to this Supplementary Standard is included for explanatory purposes only and does not form part of the requirements. The bold-faced reference numbers that introduce each item apply to the requirements in this Supplementary Standard.

A-Table 1.3.1.2. DIN - Deutsches Institut für Normung e. V. (German Institute for Standardization).

Name	Address	Contact
DIN	DIN Deutsches Institut für Normung e. V. Am DIN-Platz Burggrafenstraße 6 10787 Berlin Germany	Phone: +49 30 2601-0 Fax: +49 30 2601-1231 web site: http://www.din.de
Column 1	2	3

A-2.1.1.3.(1) Heat Soaked Tempered Glass.

Heat soaked tempered glass is glass within which a permanent surface compressive stress has been induced in order to give it greatly increased resistance to mechanical and thermal stress and prescribed fragmentation characteristics and which has a known level of residual risk of spontaneous breakage due to the presence of critical nickel sulphide (NiS) inclusions. DIN EN 14179-1 is a European standard that specifies the heat soak process system together with tolerances, flatness, edgework, fragmentation and physical and mechanical characteristics of monolithic flat heat soaked thermally toughened soda lime silicate safety glass for use in buildings.

A-3.1.1.1.(1) Structural Design.

Part 4 of Division B of the Building Code applies to buildings described in Sentence 1.1.2.2.(1) of Division A of the Building Code. When considering the load combinations on exterior balcony guards, Part 4 requires that the live load should be considered in combination with the wind load. Refer to Table 4.1.3.2. of Division B of the Building Code for the relevant load combinations. Case 2, with the full live load coupled with a reduced wind load (via the 0.4 factor) is a plausible scenario. It is also plausible that some fraction of the live load may be present during the design wind event as per the load combination in case 4. Therefore, the live load needs to be considered in combination with the wind load via the load combinations in cases 2 and 4. The wind load, when combined with the live load, should be the outward wind load (i.e.: acting as a suction load on the guard) that is applied in combination with the outward guard load, and, as a separate case, the inward wind load (i.e.: acting as a pressure load on the guard) that is applied in combination with the inward guard load.

MMAH Supplementary Standard SC-1

Code of Conduct for Registered Code Agencies

September 14, 2012

COMMENCEMENT

MMAH Supplementary Standard SC-1 comes into force on the 1st day of January, 2014.

© Copyright

© Copyright Queen's Printer for Ontario 2012

All rights reserved.

Questions regarding copyright, including reproduction and distribution, may be directed to the Director,
Building and Development Branch of the Ministry of Municipal Affairs and Housing.

SC-1 Code of Conduct for Registered Code Agencies

1. Standards

A registered code agency shall at all times undertake its responsibilities in a professional manner, and in conformance with the provisions of the Building Code Act, 1992, the building code, and all applicable legislation.

Building code provisions which contain requirements pertaining to the conduct of a registered code agency, include:

Division C	Requirements
Sentence 3.4.3.9.(2)	Suspension, Revocation, Refusal to Register or Renew a Registration
Subsection 3.7.2.	When a Registered Code Agency may not be Appointed or Continue to Act Under an Appointment
Sentence 3.7.4.1.(1)	Manner in which a Registered Code Agency shall Perform Functions
Article 3.7.4.3.	Issuance of Certificates by Registered Code Agencies
Article 3.7.4.4.	Issuance of Orders by Registered Code Agencies
Article 3.7.4.5.	Authorized Persons
Article 3.7.4.6.	Prohibition
Article 3.7.4.7.	Information and Records
Sentence 3.7.6.2.(1)	Information to be Provided by a Registered Code Agency to the Director
Article 3.7.6.3.	Information to be Provided by a Registered Code Agency to the Chief Building Official
Subsection 3.7.7.	Referral of Stop Work Order
Column 1	2

2. Application

A registered code agency shall ensure that its officers, directors, employees and other persons engaged to perform functions on behalf of the registered code agency, perform their functions in a manner consistent with the code of conduct.

3. Respect

A registered code agency, while carrying out its functions under an appointment, shall treat persons applying for or holding permits under section 8 of the Building Code Act, as well as persons responsible for design activities, persons engaged in construction, and other persons with whom a registered code agency may come into contact in the course of carrying out its responsibilities, with respect, by being courteous at all times and in all situations.

Application for a Permit to Construct or Demolish

This form is authorized under subsection 8(1.1) of the *Building Code Act, 1992*

For use by Principal Authority				
Application number:		Permit number (if different):		
Date received:		Roll number:		
Application submitted to: _____ (Name of municipality, upper-tier municipality, board of health or conservation authority)				
A. Project information				
Building number, street name			Unit number	Lot/con.
Municipality	Postal code	Plan number/other description		
Project value est. \$		Area of work (m ²)		
B. Purpose of application				
New construction	Addition to an existing building	Alteration/repair	Demolition	Conditional Permit
Proposed use of building		Current use of building		
Description of proposed work				
C. Applicant				
Applicant is:		Owner or Authorized agent of owner		
Last name	First name	Corporation or partnership		
Street address			Unit number	Lot/con.
Municipality	Postal code	Province	E-mail	
Telephone number ()	Fax ()		Cell number ()	
D. Owner (if different from applicant)				
Last name		First name	Corporation or partnership	
Street address			Unit number	Lot/con.
Municipality	Postal code	Province	E-mail	
Telephone number ()	Fax ()		Cell number ()	

Application for a Permit to Construct or Demolish – Effective January 1, 2014

E. Builder (optional)				
Last name		First name	Corporation or partnership (if applicable)	
Street address			Unit number	Lot/con.
Municipality	Postal code	Province	E-mail	
Telephone number ()	Fax ()		Cell number ()	
F. Tarion Warranty Corporation (Ontario New Home Warranty Program)				
i. Is proposed construction for a new home as defined in the <i>Ontario New Home Warranties Plan Act</i> ? If no, go to section G.			Yes	No
ii. Is registration required under the <i>Ontario New Home Warranties Plan Act</i> ?			Yes	No
iii. If yes to (ii) provide registration number(s): _____				
G. Required Schedules				
i) Attach Schedule 1 for each individual who reviews and takes responsibility for design activities.				
ii) Attach Schedule 2 where application is to construct on-site, install or repair a sewage system.				
H. Completeness and compliance with applicable law				
i) This application meets all the requirements of Clauses 1.3.1.3.(5)(a) to (d) of Division C of the Building Code (the application is made in the correct form and by the owner or authorized agent, all applicable fields have been completed on the application and required schedules, and all required schedules are submitted). Payment has been made of all fees that are required, under the applicable by-law, resolution or regulation made under clause 7(1)(c) of the <i>Building Code Act, 1992</i> , to be paid when the application is made.			Yes	No
ii) This application is accompanied by the plans and specifications prescribed by the applicable by-law, resolution or regulation made under clause 7(1)(b) of the <i>Building Code Act, 1992</i> .			Yes	No
iii) This application is accompanied by the information and documents prescribed by the applicable by-law, resolution or regulation made under clause 7(1)(b) of the <i>Building Code Act, 1992</i> which enable the chief building official to determine whether the proposed building, construction or demolition will contravene any applicable law.			Yes	No
iv) The proposed building, construction or demolition will not contravene any applicable law.			Yes	No
I. Declaration of applicant				
I _____ declare that: (print name)				
1. The information contained in this application, attached schedules, attached plans and specifications, and other attached documentation is true to the best of my knowledge.				
2. If the owner is a corporation or partnership, I have the authority to bind the corporation or partnership.				
_____		_____		
Date		Signature of applicant		

Personal information contained in this form and schedules is collected under the authority of subsection 8(1.1) of the *Building Code Act, 1992*, and will be used in the administration and enforcement of the *Building Code Act, 1992*. Questions about the collection of personal information may be addressed to: a) the Chief Building Official of the municipality or upper-tier municipality to which this application is being made, or, b) the inspector having the powers and duties of a chief building official in relation to sewage systems or plumbing for an upper-tier municipality, board of health or conservation authority to whom this application is made, or, c) Director, Building and Development Branch, Ministry of Municipal Affairs and Housing, 777 Bay St., 2nd Floor, Toronto, M5G 2E5, (416) 585-6666.

Schedule 1: Designer Information

Use one form for each individual who reviews and takes responsibility for design activities with respect to the project.

A. Project Information			
Building number, street name	Unit no.	Lot/con.	
Municipality	Postal code	Plan number/other description	
B. Individual who reviews and takes responsibility for design activities			
Name	Firm		
Street address	Unit no.	Lot/con.	
Municipality	Postal code	Province	E-mail
Telephone number ()	Fax number ()	Cell number ()	
C. Design activities undertaken by individual identified in Section B. [Building Code Table 3.5.2.1. of Division C]			
House	HVAC – House	Building Structural	
Small Buildings	Building Services	Plumbing – House	
Large Buildings	Detection, Lighting and Power	Plumbing – All Buildings	
Complex Buildings	Fire Protection	On-site Sewage Systems	
Description of designer's work			
D. Declaration of Designer			
<p>I _____ declare that (choose one as appropriate):</p> <p style="text-align: center;">(print name)</p> <p>I review and take responsibility for the design work on behalf of a firm registered under Subsection 3.2.4. of Division C, of the Building Code. I am qualified, and the firm is registered, in the appropriate classes/categories.</p> <p style="padding-left: 40px;">Individual BCIN: _____</p> <p style="padding-left: 40px;">Firm BCIN: _____</p> <p>I review and take responsibility for the design and am qualified in the appropriate category as an "other designer" under Subsection 3.2.5. of Division C, of the Building Code.</p> <p style="padding-left: 40px;">Individual BCIN: _____</p> <p style="padding-left: 40px;">Basis for exemption from registration: _____</p> <p>The design work is exempt from the registration and qualification requirements of the Building Code.</p> <p style="padding-left: 40px;">Basis for exemption from registration and qualification: _____</p> <p>I certify that:</p> <ol style="list-style-type: none"> 1. The information contained in this schedule is true to the best of my knowledge. 2. I have submitted this application with the knowledge and consent of the firm. <p style="margin-top: 20px;"> </p> <p style="margin-top: 5px;"> Date Signature of Designer </p>			

NOTE:

1. For the purposes of this form, "individual" means the "person" referred to in Clause 3.2.4.7.(1)(c) of Division C, Article 3.2.5.1. of Division C, and all other persons who are exempt from qualification under Subsections 3.2.4. and 3.2.5. of Division C.
2. Schedule 1 is not required to be completed by a holder of a license, temporary license, or a certificate of practice, issued by the Ontario Association of Architects. Schedule 1 is also not required to be completed by a holder of a license to practise, a limited license to practise, or a certificate of authorization, issued by the Association of Professional Engineers of Ontario.

Schedule 2: Sewage System Installer Information

A. Project Information			
Building number, street name		Unit number	Lot/con.
Municipality	Postal code	Plan number/ other description	
B. Sewage system installer			
Is the installer of the sewage system engaged in the business of constructing on-site, installing, repairing, servicing, cleaning or emptying sewage systems, in accordance with Building Code Article 3.3.1.1. of Division C?			
Yes (Continue to Section C)		No (Continue to Section E)	
		Installer unknown at time of application (Continue to Section E)	
C. Registered installer information (where answer to B is "Yes")			
Name		BCIN	
Street address		Unit number	Lot/con.
Municipality	Postal code	Province	E-mail
Telephone number ()	Fax ()	Cell number ()	
D. Qualified supervisor information (where answer to section B is "Yes")			
Name of qualified supervisor(s)		Building Code Identification Number (BCIN)	
E. Declaration of Applicant:			
<p>I _____ declare that:</p> <p style="text-align: center;">(print name)</p> <p>I am the applicant for the permit to construct the sewage system. If the installer is unknown at time of application, I shall submit a new Schedule 2 prior to construction when the installer is known;</p> <p><u>OR</u></p> <p>I am the holder of the permit to construct the sewage system, and am submitting a new Schedule 2, now that the installer is known.</p> <p>I certify that:</p> <ol style="list-style-type: none"> 1. The information contained in this schedule is true to the best of my knowledge. 2. If the owner is a corporation or partnership, I have the authority to bind the corporation or partnership. <p>_____</p> <p style="display: flex; justify-content: space-between;"> Date Signature of applicant </p>			

Principal Authority/Registered Code Agency Identification
Name, Address, Telephone No, Building Code Identification Number

Order Not to Cover or Enclose

Pursuant to Subsection 13(1) of the *Building Code Act, 1992*

Order Number: (optional) _____

Date Order issued: _____

Address to which Order applies:

Application/Permit Number:

Order issued to (name and address):

1.

3.

2.

4.

The above-referenced building was inspected on or about _____ (date).

You are hereby prohibited from covering or enclosing the parts of the building described below, pending an inspection. Please arrange for an inspection when the part of the building identified below is ready for inspection.

Item	Description of area not to cover or enclose

Order issued by:

Name _____

BCIN _____

Signature _____

Telephone _____

Contact name (optional) _____

Contact tel. number (optional) _____

Note:

- It is illegal to obstruct the visibility of a posted Order. It is also illegal to remove a posted Order unless authorized by an inspector or Registered Code Agency. [*Building Code Act, 1992 s. 20*]
- An Order may be appealed to the Superior Court of Justice. [*Building Code Act, 1992 s. 25*]. It may also be appealed to the Building Code Commission concerning the sufficiency of compliance with the technical requirements of the Building Code. [*Building Code Act, 1992 s. 24*]
- Failure to comply with this Order could result in an Order to Uncover and/or a Stop Work Order. [*Building Code Act, 1992 s. 13(6) and/or s. 14*]
- Failure to comply with an Order is an offence which could result in a fine. [*Building Code Act, 1992 s. 36*]

Principal Authority/Registered Code Agency Identification
Name, Address, Telephone No, Building Code Identification Number

Order to Uncover

Pursuant to Subsection 13(6) of the *Building Code Act, 1992*

Order Number: (optional) _____

Date Order issued: _____

Address to which Order applies:

Application/Permit Number:

Order issued to (name and address):

1. _____
2. _____
3. _____
4. _____

The inspection on or about _____ (date) at the above-referenced address found the following contravention(s) of the *Building Code Act, 1992* or the Building Code.

The part was covered or enclosed contrary to an Order Not to Cover number _____ dated _____;

The notice required to be given to the chief building official, registered code agent or inspector, before the part was covered or enclosed under a by-law, resolution or regulation made under clause 7(1)(e) of the *Building Code Act, 1992*, was not given or a notice required under section 10.2 was not received;

In cases where a notice required under section 10.2 is received, the period prescribed under subsection 10.2 (2) did not elapse before the part was covered or enclosed;

In cases where a notice required by a by-law, resolution or regulation made under clause 7(1)(e) is given,

- (i) the inspection period prescribed under clause 7(1)(e) did not elapse before the part was covered or enclosed
- (ii) if an inspection period is not prescribed under clause 7(1)(e) a reasonable period of time after the notice was given did not elapse before the part was covered or enclosed; or

The part has been constructed without a permit being issued.

You are hereby ordered to uncover or have uncovered, at your own expense, and make available for inspection the parts of the building described below immediately, or by _____ (date).

Description of area to uncover:

Order issued by:

Name _____ BCIN _____

Signature _____ Telephone _____

Contact name (optional) _____ Contact tel. number (optional) _____

Note:

- It is illegal to obstruct the visibility of a posted Order. It is also illegal to remove a posted Order unless authorized by an inspector or Registered Code Agency. [*Building Code Act, 1992* s. 20]
- An Order may be appealed to the Superior Court of Justice. [*Building Code Act, 1992* s. 25]. It may also be appealed to the Building Code Commission concerning the sufficiency of compliance with the technical requirements of the Building Code. [*Building Code Act, 1992* s. 24]
- Failure to comply with this Order could result in a Stop Work Order. [*Building Code Act, 1992* s. 14]
- Failure to comply with an Order is an offence which could result in a fine. [*Building Code Act, 1992* s. 36]

Principal Authority/Registered Code Agency Identification
Name, Address, Telephone No, Building Code Identification Number

Stop Work Order

Pursuant to Subsection 14(1) of the *Building Code Act, 1992*

Order Number: (optional) _____

Date Order issued: _____

Address to which Order applies:

Application/Permit Number:

Order issued to (name and address):

1. _____
2. _____
3. _____
4. _____

The inspection on or about _____ (date) at the above-referenced address found the following contravention(s) of the *Building Code Act, 1992* or the Building Code have not been rectified as required by the Order(s) indicated below:

Order to Comply number _____, dated _____
Order Not to Cover number _____, dated _____
Order to Uncover number _____, dated _____

You are hereby ordered to immediately cease construction and/or demolition as specified below:

Item	Details

Order issued by:

Name _____ BCIN _____
Signature _____ Telephone no. _____
Contact name (optional) _____ Contact tel. number (optional) _____

Note:

- It is illegal to obstruct the visibility of a posted Order. It is also illegal to remove a posted Order unless authorized by an inspector or Registered Code Agency. [*Building Code Act, 1992 s. 20*]
- An Order may be appealed to the Superior Court of Justice. [*Building Code Act, 1992 s. 25*]. It may also be appealed to the Building Code Commission concerning the sufficiency of compliance with the technical requirements of the Building Code. [*Building Code Act, 1992 s. 24*]
- Failure to comply with this Order is an offence which could result in a fine. [*Building Code Act, 1992 s. 36*]
- When a Stop Work Order is issued, no person shall perform any act in the construction or demolition of the building in respect of which the Order is made other than work necessary to carry out an Order to Comply, the Order Not to Cover, or an Order to Uncover. [*Building Code Act, 1992 s. 14*]

Principal Authority/Registered Code Agency Identification
Name, Address, Telephone No, Building Code Identification Number

Order Requiring Tests and Samples

Pursuant to Clause 18(1)(f) of the *Building Code Act, 1992*

Order Number: (optional) _____

Date Order issued: _____

Address to which Order applies:

Application/Permit Number:

Order issued to (name and address):

1.

3.

2.

4.

Description of required tests and samples

The inspection on or about _____ (date) at the above-referenced address found the need for the following tests and samples.

You are hereby ordered at your expense to take and supply to the undersigned the tests and samples described below by _____ (date).

Item	Reference	Test and sample required

Order issued by:

Name _____

BCIN _____

Signature _____

Telephone _____

Contact name (optional) _____

Contact tel. number (optional) _____

Note:

- It is illegal to obstruct the visibility of a posted Order. It is also illegal to remove a posted Order unless authorized by an inspector or Registered Code Agency. [*Building Code Act, 1992 s. 20*]
- An Order may be appealed to the Superior Court of Justice. [*Building Code Act, 1992 s. 25*]. It may also be appealed to the Building Code Commission concerning the sufficiency of compliance with the technical requirements of the Building Code. [*Building Code Act, 1992 s. 24*]
- Failure to comply with an Order is an offence which could result in a fine. [*Building Code Act, 1992 s. 36*]

Principal Authority/Registered Code Agency Identification
Name, Address, Telephone No, Building Code Identification Number

Order to Comply

Pursuant to Subsection 12(2) of the *Building Code Act, 1992*

Order Number: (optional) _____

Date Order issued: _____

Address to which Order applies:

Application/Permit Number:

Order issued to (name and address):

- | | |
|----|----|
| 1. | 3. |
| 2. | 4. |

The inspection on or about _____ (date) at the above-referenced address found the following contravention(s) of the Building Code or the *Building Code Act, 1992*.

You are hereby ordered to correct the contraventions itemized below immediately, by the dates listed below, or by _____ (date).

Item	Reference	Description and location	Required action and compliance date

Order issued by:

Name _____ BCIN _____

Signature _____ Telephone _____

Contact name (optional) _____ Contact tel. number (optional) _____

Note:

- It is illegal to obstruct the visibility of a posted Order. It is also illegal to remove a posted Order unless authorized by an inspector or Registered Code Agency. [*Building Code Act, 1992 s. 20*]
- An Order may be appealed to the Superior Court of Justice. [*Building Code Act, 1992 s. 25*]. It may also be appealed to the Building Code Commission concerning the sufficiency of compliance with the technical requirements of the Building Code. [*Building Code Act, 1992 s. 24*]
- Failure to comply with this Order could result in a Stop Work Order. [*Building Code Act, 1992 s. 14*]
- Failure to comply with this Order is an offence which could result in a fine. [*Building Code Act, 1992 s. 36*]
- No construction affected by this Order is to be covered until inspected and approved. [*Building Code Act, 1992 s. 13*]

Principal Authority/Registered Code Agency Identification
Name, Address, Telephone No, Building Code Identification Number

Order to Comply

Pursuant to Subsection 15.10.1.(2) of the *Building Code Act, 1992*

Order Number: (optional) _____

Date Order issued: _____

Address to which Order applies:

Order issued to (name and address):

1. _____
2. _____
3. _____
4. _____

The inspection on or about _____ (date) at the above-referenced address found the following contravention(s) of the Building Code or the *Building Code Act, 1992*.

You are hereby ordered to correct the contraventions itemized below immediately, by the dates listed below, or by _____ (date).

Item	Reference	Description and location	Required action and compliance date

Order issued by:

Name _____ BCIN _____

Signature _____ Telephone _____

Contact name (optional) _____ Contact tel. number (optional) _____

Note:

- It is illegal to obstruct the visibility of a posted Order. It is also illegal to remove a posted Order unless authorized by an inspector or Registered Code Agency. [*Building Code Act, 1992 s. 20*]
- An Order may be appealed to the Superior Court of Justice. [*Building Code Act, 1992 s. 25*]. It may also be appealed to the Building Code Commission concerning the sufficiency of compliance with the technical requirements of the Building Code. [*Building Code Act, 1992 s. 24*]
- Failure to comply with this Order is an offence which could result in a fine. [*Building Code Act, 1992 s. 36*]

